

TO :

文件编号

HXA-L01-01(01)

发行日期

2019年07月12日

承认规格书

种类：Ferrite Chip Bead系列号：SFB1005LW-Series客户料号：

客户承认栏

承认日期

年 月 日

(贵司承认后请签署一份返回华信安电子, 谢谢!)

厦门华信安电子科技有限公司技术质量部

承认	确认	作成
龙梅	梁峰	王亮

TEL : 0592-6301603 FAX : 0592-5205265

Http : www.xmisnd.com

Ferrite Chip Bead(Lead Free)

SFB1005LW-Series

1.Features

- 1.Monolithic inorganic material construction.
- 2.Closed magnetic circuit avoids crosstalk.
- 3.S.M.T. type.
- 4.Suitable for flow and reflow soldering.
- 5.Shapes and dimensions follow E.I.A. spec.
- 6.Available in various sizes.
- 7.Excellent solderability and heat resistance.
- 8.High reliability.
- 9.This component is compliant with RoHS legislation and also support lead-free soldering.

2.Dimensions

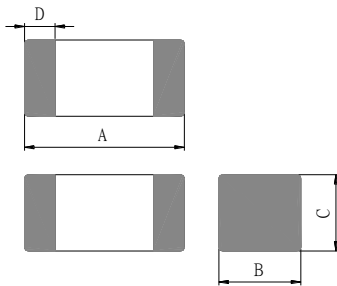

Chip Size	
A	1.00±0.10
B	0.50±0.10
C	0.50±0.10
D	0.25±0.10

Units: mm

3.Part Numbering



A: Series
 B: Dimension L x W
 C: Material Lead Free Material
 D: Impedance 121=120Ω
 E: Packaging T=Taping and Reel, B=Bulk(Bags)
 F: Rated Current 01=100mA

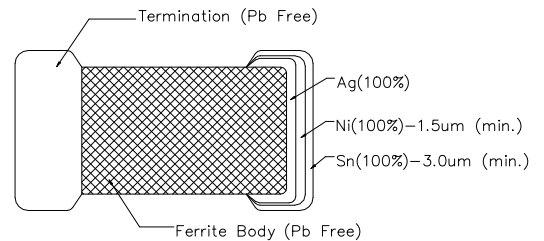

4.Specification

ISND Part Number	Impedance (Ω)	Test Frequency (MHz)	DC Resistance (Ω) max.	Rated Current (mA)
SFB1005LW-300T03	30±25%	100	0.20	300
SFB1005LW-600T03	60±25%	100	0.25	300
SFB1005LW-121T01	120±25%	100	0.30	100
SFB1005LW-151T01	150±25%	100	0.30	100
SFB1005LW-221T05	220±25%	100	0.40	500
SFB1005LW-301T03	300±25%	100	0.50	100
SFB1005LW-471T01	470±25%	100	0.65	100
SFB1005LW-601T05	600±25%	100	0.80	500
SFB1005LW-600T03	60±25%	100	0.30	300
SFB1005LW-121T05	120±25%	100	0.30	500
SFB1005LW-221T06	220±25%	100	0.60	600
SFB1005LW-301T05	300±25%	100	0.75	500
SFB1005LW-102T03	1000±25%	100	1.20	300

5. Reliability and Test Condition

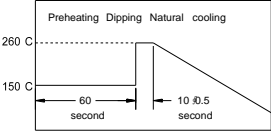
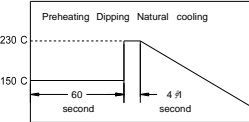
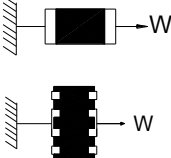
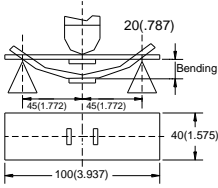
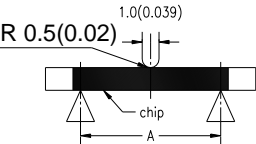
Item	Performance		Test Condition																								
Series No.	SFB		--																								
Operating Temperature	-55~+125°C		--																								
Storage Temperature	-55~+125°C		--																								
Impedance (Z)	Refer to standard electrical characteristics list		HP4291A, HP4287A+16092A																								
Inductance (Ls)																											
Q Factor																											
DC Resistance																											
Rated Current																											
Rated Current			**																								
Temperature Rise Test	30°C max. (ΔT)		1. Applied the allowed DC current. 2. Temperature measured by digital surface thermometer.																								
Solder heat Resistance	Appearance: No significant abnormality. Impedance change: Within ± 30%.	No mechanical damage. Remaining terminal electrode:70% min.	Preheat: 150°C,60sec. Solder: Sn-Ag3.0-Cu0.5 Solder temperature: 260±5°C Flux for lead free: rosin Dip time: 10±0.5sec. 																								
Solderability	More than 90% of the terminal electrode should be covered with solder.		Preheat: 150°C,60sec. Solder: Sn-Ag3.0-Cu0.5 Solder temperature: 230±5°C Flux for lead free: rosin Dip time: 4±1sec.																								
Terminal strength	The terminal electrode and the dielectric must not be damaged by the forces applied on the right conditions.		For SFB: <table border="1"> <thead> <tr> <th>Size</th> <th>Force (Kgf)</th> <th>Time(sec)</th> </tr> </thead> <tbody> <tr> <td>1005</td> <td>0.2</td> <td></td> </tr> <tr> <td>1608</td> <td>0.5</td> <td></td> </tr> <tr> <td>2012</td> <td>0.6</td> <td></td> </tr> <tr> <td>3216</td> <td>1.0</td> <td>>25</td> </tr> <tr> <td>3225</td> <td>1.0</td> <td></td> </tr> <tr> <td>4516</td> <td>1.0</td> <td></td> </tr> <tr> <td>4532</td> <td>1.5</td> <td></td> </tr> </tbody> </table>	Size	Force (Kgf)	Time(sec)	1005	0.2		1608	0.5		2012	0.6		3216	1.0	>25	3225	1.0		4516	1.0		4532	1.5	
Size	Force (Kgf)	Time(sec)																									
1005	0.2																										
1608	0.5																										
2012	0.6																										
3216	1.0	>25																									
3225	1.0																										
4516	1.0																										
4532	1.5																										
Flexture strength	The terminal electrode and the dielectric must not be damaged by the forces applied on the right conditions.		Solder a chip on a test substrate, bend the substrate by 2mm (0.079in)and return.																								
Bending Strength	The ferrite should not be damaged by Forces applied on the right condition.		<table border="1"> <thead> <tr> <th>Size</th> <th>mm(inches)</th> <th>P-Kgf</th> </tr> </thead> <tbody> <tr> <td>1608</td> <td>0.80(0.033)</td> <td>0.3</td> </tr> <tr> <td>2012</td> <td>1.40(0.055)</td> <td>1.0</td> </tr> <tr> <td>3216</td> <td rowspan="2">2.00(0.079)</td> <td rowspan="2">2.5</td> </tr> <tr> <td>3225</td> </tr> <tr> <td>4516</td> <td rowspan="3">2.70(0.106)</td> <td rowspan="3">2.5</td> </tr> <tr> <td>4532</td> </tr> <tr> <td>5750</td> </tr> </tbody> </table>	Size	mm(inches)	P-Kgf	1608	0.80(0.033)	0.3	2012	1.40(0.055)	1.0	3216	2.00(0.079)	2.5	3225	4516	2.70(0.106)	2.5	4532	5750						
Size	mm(inches)	P-Kgf																									
1608	0.80(0.033)	0.3																									
2012	1.40(0.055)	1.0																									
3216	2.00(0.079)	2.5																									
3225																											
4516	2.70(0.106)	2.5																									
4532																											
5750																											
Random Vibration Test	Appearance: Cracking, shipping and any other defects harmful to the characteristics should not be allowed. Impedance: within±30%		Frequency: 10-55-10Hz for 1 min. Amplitude: 1.52mm Directions and times: X, Y, Z directions for 2 hours. A period of 2 hours in each of 3 mutually perpendicular directions (Total 6 hours).																								
Drop	Drop 10 times on a concrete floor from a height of 75cm		a: No mechanical damage b: Impedance change: ±30%																								

Item	Performance	Test Condition																		
Loading at High Temperature	Appearance: no damage.	Temperature: 125±5°C (bead), 85±5°C (inductor) Applied current: rated current. Duration: 500±12hrs. Measured at room temperature after placing for 2 to 3hrs.																		
Humidity	Impedance: within±30% of initial value. Inductance: within±10% of initial value. Q: within±30% of initial value. (HXCI HXHI HXCH)	Humidity: 90~95%RH. Temperature: 40±2°C. Temperature: 60±2°C. (HCI) Duration: 500±12hrs. Measured at room temperature after placing for 2 to 3hrs.																		
Thermal shock	Appearance: no damage. Impedance: within±30% of initial value. Inductance: within±10% of initial value. Q: within±30% of initial value. (HXCI)	For SFB : Condition for 1 cycle Step1: -55±2°C 30±3 min. Step2: +125±5°C 30±3 min. Number of cycles: 5 For HXCI Condition for 1 cycle Step1: -40±2°C 30±3 min. Step2: +85±5°C 30±3 min. Number of cycles: 100 Measured at room temperature after placing for 2 to 3 hrs.																		
Low temperature storage test	For Bead : <table border="1"> <thead> <tr> <th>Phase</th> <th>Temperature(°C)</th> <th>Time(min.)</th> </tr> </thead> <tbody> <tr> <td>1</td> <td>-55±2°C</td> <td>30±3</td> </tr> <tr> <td>2</td> <td>+125±5°C</td> <td>30±3</td> </tr> </tbody> </table> Measured: 5 times For Inductor : <table border="1"> <thead> <tr> <th>Phase</th> <th>Temperature(°C)</th> <th>Time(min.)</th> </tr> </thead> <tbody> <tr> <td>1</td> <td>-40±2°C</td> <td>30±3</td> </tr> <tr> <td>2</td> <td>+85±5°C</td> <td>30±3</td> </tr> </tbody> </table> Measured: 100 times	Phase	Temperature(°C)	Time(min.)	1	-55±2°C	30±3	2	+125±5°C	30±3	Phase	Temperature(°C)	Time(min.)	1	-40±2°C	30±3	2	+85±5°C	30±3	Temperature: -55±2°C. Duration: 500±12hrs. Measured at room temperature after placing for 2 to 3hrs.
Phase	Temperature(°C)	Time(min.)																		
1	-55±2°C	30±3																		
2	+125±5°C	30±3																		
Phase	Temperature(°C)	Time(min.)																		
1	-40±2°C	30±3																		
2	+85±5°C	30±3																		
Drop	Drop 10 times on a concrete floor from a height of 75cm	a: No mechanical damage b: Impedance change: ±30%																		

****Derating Curve**

For the ferrite chip bead which withstanding current over 1.5A, as the operating temperature over 85°C, the derating current information is necessary to consider with. For the detail derating of current, please refer to the Derated Current vs. Operating Temperature curve.

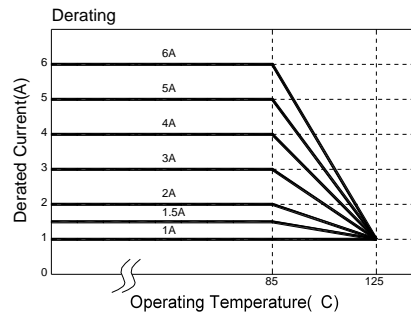

6.Soldering and Mounting

6-1. Recommended PC Board Pattern

Series	Type	Chip Size				Land Patterns For Reflow Soldering		
		A(mm)	B(mm)	C(mm)	D(mm)	L(mm)	G(mm)	H(mm)
SFB	1005	1.0±0.10	0.50±0.10	0.50±0.10	0.25±0.10	2.10	0.50	0.55
	1608	1.6±0.15	0.80±0.15	0.80±0.15	0.30±0.20	2.60	0.60	0.80
SFB	2012	2.0±0.20	1.25±0.20	0.85±0.20	0.50±0.30	3.00	1.00	1.00
		2.0±0.20	1.25±0.20	1.25±0.20	0.50±0.30			
SFB	2520	2.5±0.20	2.00±0.20	1.60±0.20	0.50±0.30	3.90	1.50	1.50
	3216	3.2±0.20	1.60±0.20	1.10±0.20	0.50±0.30	4.40	2.20	1.40
SFB	3225	3.2±0.20	2.50±0.20	1.30±0.20	0.50±0.30	4.40	2.20	3.40
	4516	4.5±0.20	1.60±0.20	1.60±0.20	0.50±0.30	5.70	2.70	1.40
SFB	4532	4.5±0.20	3.20±0.20	1.50±0.20	0.50±0.30	5.90	2.57	4.22

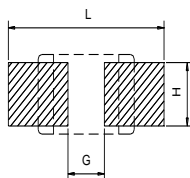

PC board should be designed so that products are not sufficient under mechanical stress as warping the board.
Products shall be positioned in the sideways direction against the mechanical stress to prevent failure.

6-2. Soldering

Mildly activated rosin fluxes are preferred. The minimum amount of solder can lead to damage from the stresses caused by the difference in coefficients of expansion between solder, chip and substrate. The terminations are suitable for all wave and re-flow soldering systems. If hand soldering cannot be avoided, the preferred technique is the utilization of hot air soldering tools.

6-2.1 Lead Free Solder re-flow:

Recommended temperature profiles for lead free re-flow soldering in Figure 1.

6-2.2 Solder Wave:

Wave soldering is perhaps the most rigorous of surface mount soldering processes due to the steep rise in temperature seen by the circuit when immersed in the molten solder wave, typical at 230°C. Due to the risk of thermal damage to products, wave soldering of large size products is discouraged. Recommended temperature profile for wave soldering is shown in Figure 2.

6-2.3 Soldering Iron(Figure 3):

Products attachment with a soldering iron is discouraged due to the inherent process control limitations. In the event that a soldering iron must be employed the following precautions are recommended.

- Note : ·Preheat circuit and products to 150°C
- 350°C tip temperature for Ferrite chip bead (max)
- Never contact the ceramic with the iron tip
- 1.0mm tip diameter (max)
- Use a 20 watt soldering iron with tip diameter of 1.0mm
- Limit soldering time to 3 sec.

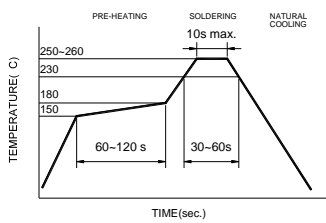

Figure 1. Re-flow Soldering(Lead Free)

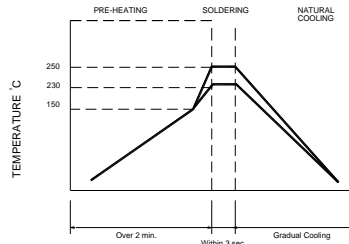

Figure 2. Wave Soldering

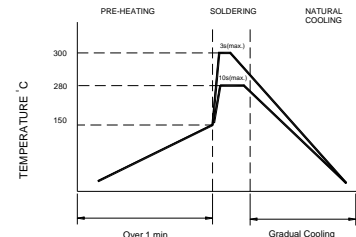
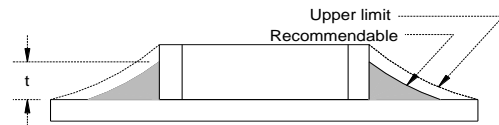

Figure 3. Hand Soldering

6-2.4 Solder Volume:

Accordingly increasing the solder volume, the mechanical stress to product is also increased. Exceeding solder volume may cause the failure of mechanical or electrical performance. Solder shall be used not to be exceed as shown in right side:



7.Packaging Information

7-1. Reel Dimension

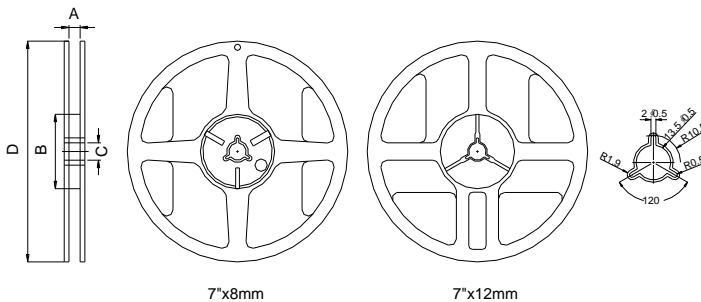

Type	A(mm)	B(mm)	C(mm)	D(mm)
7"x8mm	9.0±0.5	60±2	13.5±0.5	178±2
7"x12mm	13.5±0.5	60±2	13.5±0.5	178±2

7-2.1 Tape Dimension / 8mm

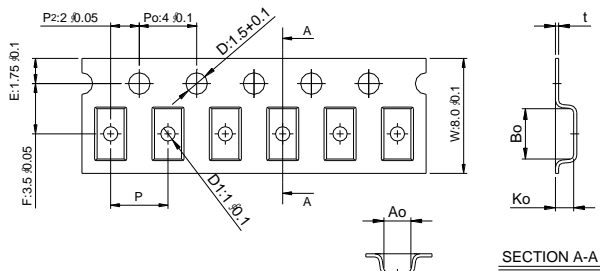

Series	Size	Bo(mm)	Ao(mm)	Ko(mm)	P(mm)	t(mm)	D1(mm)
SFB	100505	1.12±0.05	0.67±0.05	0.54±0.05	2.0±0.1	0.23±0.05	none
SFB	160808	1.80±0.10	1.01±0.10	1.02±0.10	4.0±0.1	0.22±0.05	none
SFB	201209	2.25±0.10	1.42±0.10	1.04±0.10	4.0±0.1	0.22±0.05	1.0±0.1
SFB	201212	2.35±0.10	1.50±0.10	1.45±0.10	4.0±0.1	0.22±0.05	1.0±0.1
SFB	321611	3.50±0.10	1.88±0.10	1.27±0.10	4.0±0.1	0.22±0.05	1.0±0.1
SFB I	322513	3.42±0.10	2.77±0.10	1.55±0.10	4.0±0.1	0.22±0.05	1.0±0.1

7-2.2 Tape Dimension / 12mm

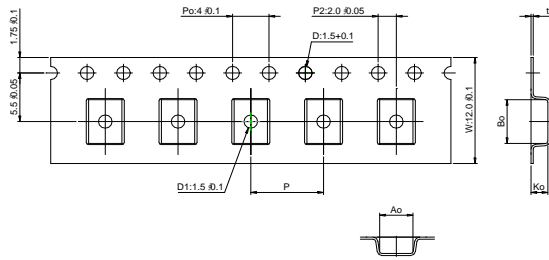

Series	Size	Bo(mm)	Ao(mm)	Ko(mm)	P(mm)	t(mm)	D1(mm)
SFB	451616	4.95±0.1	1.93±0.1	1.93±0.1	4.0±0.1	0.24±0.05	1.5±0.1
SFB	453215	4.95±0.1	3.66±0.1	1.85±0.1	8.0±0.1	0.24±0.05	1.5±0.1

7-3. Packaging Quantity

Chip Size	453215	451616	322513	321611	201212	201209	160808	100505
Chip / Reel	1000	2000	2500	3000	2000	4000	4000	10000
Inner box	4000	8000	12500	15000	10000	20000	20000	50000
Middle box	20000	40000	62500	75000	50000	100000	100000	250000
Carton	40000	80000	125000	150000	100000	200000	200000	500000
Bulk (Bags)	12000	20000	30000	50000	100000	150000	200000	300000

7-4. Tearing Off Force

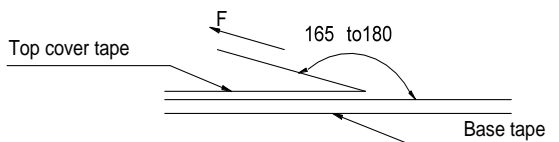

The force for tearing off cover tape is 15 to 60 grams in the arrow direction under the following conditions.

Room Temp. (°C)	Room Humidity (%)	Room atm (hPa)	Tearing Speed mm/min
5-35	45-85	860-1060	300

Application Notice

·Storage Conditions

To maintain the solderability of terminal electrodes:

1. Temperature and humidity conditions: -10~ 40°C and 30~70% RH.
2. Recommended products should be used within 6 months from the time of delivery.
3. The packaging material should be kept where no chlorine or sulfur exists in the air.

·Transportation

1. Products should be handled with care to avoid damage or contamination from perspiration and skin oils.
2. The use of tweezers or vacuum pick up is strongly recommended for individual components.
3. Bulk handling should ensure that abrasion and mechanical shock are minimized.

Impedance Frequency Characteristics(Typical)

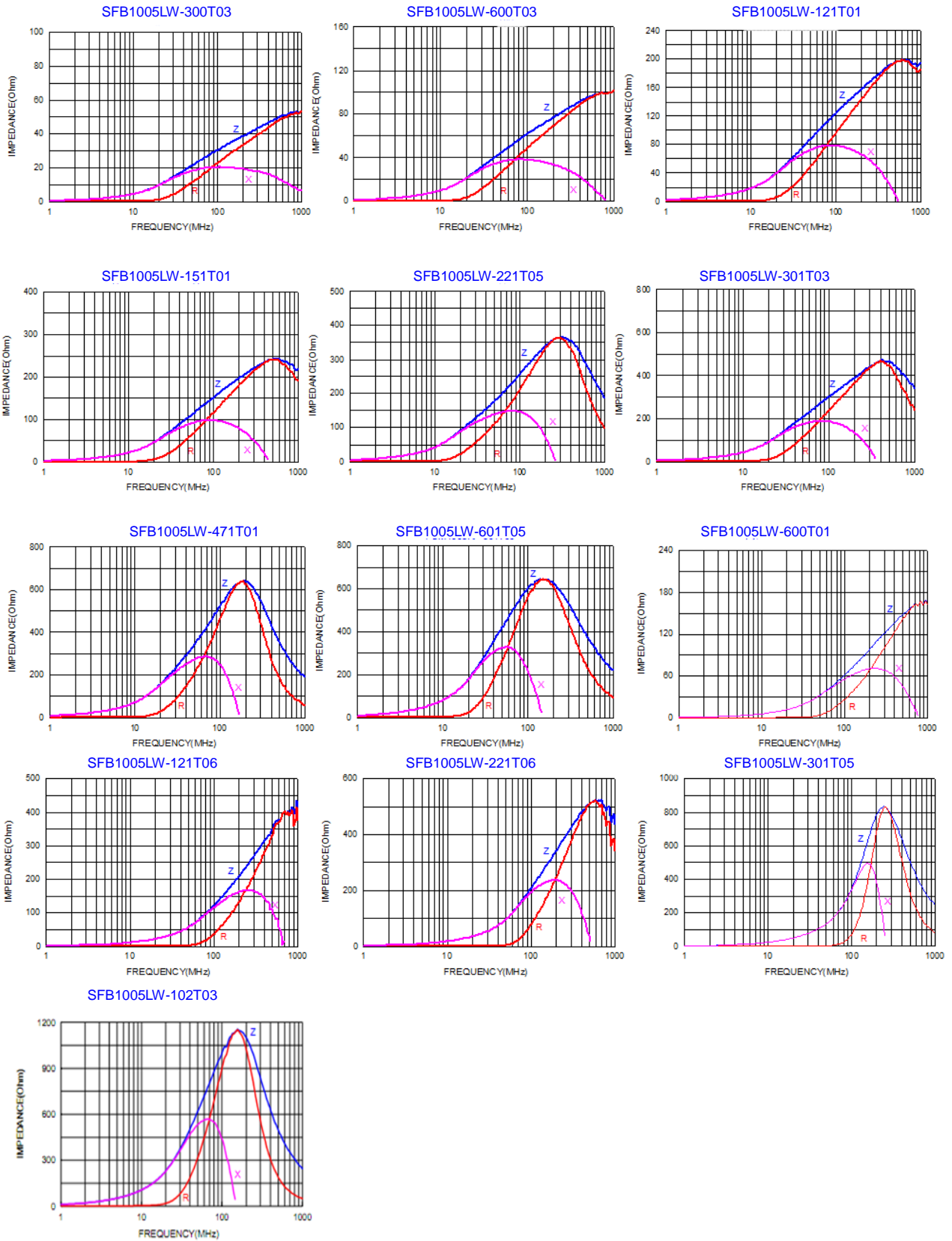

单击下面可查看定价，库存，交付和生命周期等信息

[>>ISND\(华信安\)](#)