

TO:

文件编号

HXA-L35-08(01)

发行日期

2015年12月28日

承认规格书

种类: 功率电感系列号: HCDH8D43N-Series

客户料号: _____

客户承认栏

承认日期

年 月 日

(贵司承认后请签署一份返回华信安电子, 谢谢!)

厦门华信安电子科技有限公司技术质量部

承认	确认	作成
龙梅	梁峰	王亮

TEL: 0592-6301603 FAX: 0592-5205265

Http: www.xmisnd.com

Power Inductor

HCDH8D43N-SERIES

1. Features

1. This specification applies Low Profile Power Inductors.
2. 100% Lead(Pb) & Halogen-Free and RoHS compliant.



Recommend Land pattern

2. Dimension

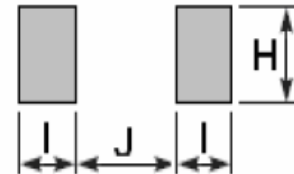
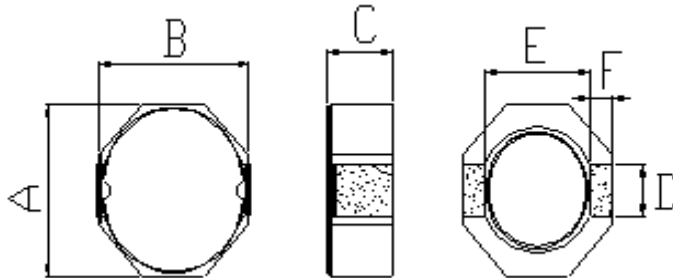

Series	A(mm)	B(mm)	C(mm)	D(mm)	E(mm)	F(mm)
HCDH8D43N	8.3	8.3	4.5 MAX	2.5 MAX	6.3	1.2

H(mm)	I(mm)	K(mm)
2.8 TYP	2.0 TYP	2.8 TYP

3. Part Numbering

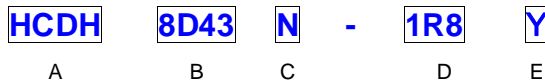

- A: Series
- B: Dimension
- C: Control S/N
- D: Inductance 1R8=1.8uH
- E: Inductance Tolerance M=±20%, Y=±30%

ISND Part Number	Inductance (uH)	Tolerance (%)	Test Frequency (Hz)	DCR (Ω) Max	I sat (A)	I rms (A)
HCDH8D43N-1R8Y	1.8	±30%	0.25V100K	0.016	5.23	5.15
HCDH8D43N-2R5Y	2.5	±30%	0.25V100K	0.020	5.12	5.00
HCDH8D43N-3R9Y	3.9	±30%	0.25V100K	0.022	4.72	4.50
HCDH8D43N-4R7Y	4.7	±30%	0.25V100K	0.022	4.18	4.00
HCDH8D43N-6R8Y	6.8	±30%	0.25V100K	0.030	4.01	3.87
HCDH8D43N-100M	10	±20%	0.25V100K	0.033	3.32	3.10
HCDH8D43N-150M	15	±20%	0.25V100K	0.075	2.47	2.35
HCDH8D43N-220M	22	±20%	0.25V100K	0.082	2.06	1.90
HCDH8D43N-330M	33	±20%	0.25V100K	0.125	1.81	1.62
HCDH8D43N-470M	47	±20%	0.25V100K	0.176	1.52	1.35
HCDH8D43N-680M	68	±20%	0.25V100K	0.247	1.33	1.20
HCDH8D43N-101M	100	±20%	0.25V100K	0.377	1.18	1.02
HCDH8D43N-151M	150	±20%	0.25V100K	0.520	0.98	0.83
HCDH8D43N-221M	220	±20%	0.25V100K	0.793	0.79	0.685
HCDH8D43N-331M	330	±20%	0.25V100K	1.23	0.65	0.54

Note:

I_{sat} : Based on inductance change (ΔL/L0 : ≤35%) @ ambient temp. 25°C

I_{rms} : Based on temperature rise (ΔT : 40°C typ.)

www.xmisnd.com

5. Reliability and Test Condition

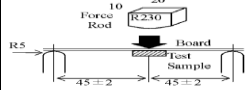
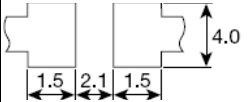
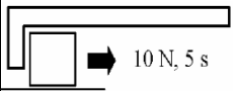
Item	Performance	Test Method and Remarks
Operating Temperature	- 40 ~ +125°C.	Including self-generated heat
Storage Temperature	-40 ~ +85°C . - 5 to 40°C for the product with taping.	
Rated current		
Inductance (L)	Within the specified tolerance	LCR Meter: HP 4285A or equivalent, 100kHz, 0.25V
DC Resistance		DC Ohmmeter: HIOKI3227 or equivalent
Temperature characteristics	Inductance change : Within±20%	Measurement of inductance shall be taken at temperature rang within-40°C to +85°C . With reference to inductance value at+20 °C ,change rate shall be calculated. Measurement of inductance shall be taken at temperature rang within-40°C to +125°C. With reference to inductance value at+20 °C ,change rate shall be calculated.
Resistance to flexure substrate	No damage.	The test samples shall be soldered to the testing board by the reflow. As illustrated below, apply force in the direction of the arrow indicating until deflection of the test board reaches to 2mm.  Substrate size : 100x40x1.0 Substrate material : glass epoxy-resin Solder cream thickness : 0.15 
Adhesion of Terminal electrode	Shall not come off PC board.	The test samples shall be soldered to the testing board and by the reflow.  Applied force : 10 N to X and Y directions. Duration : 5s Solder cream thickness : 0.15
Resistance to Vibration	Inductance change : Within±10% No abnormality observed in appearance.	The test samples shall be soldered to the test board by the reflow. Then it shall be submitted to below test conditions. Frequency: 10-55Hz Total Amplitude: 1.5mm (May not exceed acceleration 196m/S2) Sweeping Method:10Hz to 55Hz to 10Hz for 1min. Time : 2 hours each in X,Y, and Z Direction. Recovery: At least 2hrs of recovery under the standard condition after the test, followed by the measurement within 48hrs.
Solderability	At least 90% of surface of terminal electrode is covered by new solder.	The test samples shall be dipped in flux, and then immersed in molten solder as shown in below. Flux : methanol solution containing rosin 25% Solder temperature: 245±5°C Time: 5±1.0 sec. Immersion depth: All sides of mounting terminal shall be immersed.

Item	Performance	Test Method and Remarks															
Resistance to soldering		The test sample shall be exposed to reflow oven at $230\pm 5^{\circ}\text{C}$ for 40 seconds, with peak temperature at $260\pm 5^{\circ}\text{C}$ for 5 seconds, 2 times. Test board thickness: 1.0mm Test board material: glass epoxy-resin															
Thermal shock		The test samples shall be soldered to the test board by the reflow. The test samples shall be placed at specified temperature for specified time by step 1 to step 4 as shown below in sequence. The temperature cycles shall be repeated 100 cycles . <table border="1"> <thead> <tr> <th>Phase</th> <th>Temperature($^{\circ}\text{C}$)</th> <th>Time(min.)</th> </tr> </thead> <tbody> <tr> <td>1</td> <td>$-40\pm 3^{\circ}\text{C}$</td> <td>30 ± 3</td> </tr> <tr> <td>2</td> <td>Room Temp</td> <td>Within 3</td> </tr> <tr> <td>3</td> <td>$85\pm 2^{\circ}\text{C}$</td> <td>30 ± 3</td> </tr> <tr> <td>4</td> <td>Room Temp</td> <td>Within 3</td> </tr> </tbody> </table>	Phase	Temperature($^{\circ}\text{C}$)	Time(min.)	1	$-40\pm 3^{\circ}\text{C}$	30 ± 3	2	Room Temp	Within 3	3	$85\pm 2^{\circ}\text{C}$	30 ± 3	4	Room Temp	Within 3
Phase	Temperature($^{\circ}\text{C}$)	Time(min.)															
1	$-40\pm 3^{\circ}\text{C}$	30 ± 3															
2	Room Temp	Within 3															
3	$85\pm 2^{\circ}\text{C}$	30 ± 3															
4	Room Temp	Within 3															
Damp heat life test	Inductance change : Within $\pm 10\%$ No abnormality observed in appearance.	Test Method and Remarks The test samples shall be soldered to the test board by the reflow. The test samples shall be placed in thermostatic oven set at specified temperature and humidity as shown in below. Temperature: $60\pm 2^{\circ}\text{C}$ Humidity: 90~95%RH Time: 500+24/-0 hrs															
Loading under damp heat life test		The test samples shall be soldered to the test board by the reflow. The test samples shall be placed in thermostatic oven set at specified temperature and humidity and applied the rated current continuously as shown in below. Temperature: $60\pm 2^{\circ}\text{C}$ Humidity: 90~95%RH Applied current: Rated current Time: 500+24/-0 hrs															
Low temperature life test		The test samples shall be soldered to the test board by the reflow. After that, the test samples shall be placed at test conditions as shown in below. Temperature: $-40\pm 2^{\circ}\text{C}$ Time: 500+24/-0 hrs															
Loading at high temperature life test		The test samples shall be soldered to the test board by the reflow. Temperature: $85\pm 2^{\circ}\text{C}$. Applied current: Rated current Time: 500+24/-0 hrs.															

6. Soldering

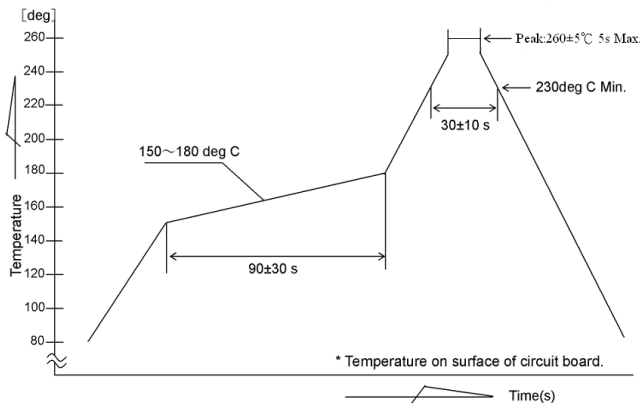

7. Packaging Information

(1) Reel Dimension

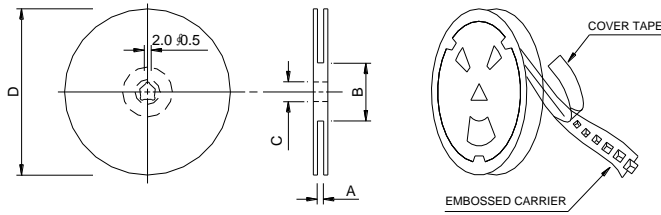

Type	A(mm)	B(mm)	C(mm)	D(mm)
HCDH8D43N	16.4±0.2	100±4.0	13.2±0.2	330±2.0

(2) Tape Dimension

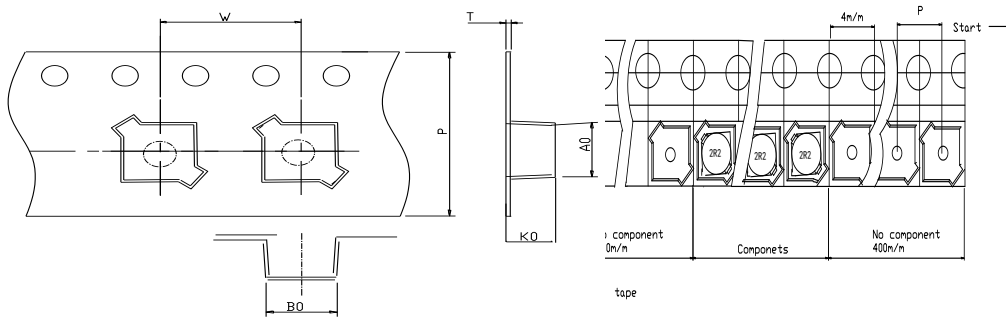

Type	Ao(mm)	Bo(mm)	Ko(mm)	P(mm)	W(mm)	t(mm)
HCDH8D43N	8.4±0.1	8.4±0.1	4.7±0.1	12.0±0.1	16±0.3	0.4±0.05

(3) Packaging Quantity

Type	Chip / Reel
HCDH8D43N	1000

Application Notice

Storage Conditions

To maintain the solderability of terminal electrodes:

1. ISND products meet IPC/JEDEC J-STD-020D standard-MSL, level 1.
2. Temperature and humidity conditions: Less than 40°C and 60% RH.
3. Recommended products should be used within 12 months from the time of delivery.
4. The packaging material should be kept where no chlorine or sulfur exists in the air.

Transportation

1. Products should be handled with care to avoid damage or contamination from perspiration and skin oils.
2. The use of tweezers or vacuum pick up is strongly recommended for individual components.
3. Bulk handling should ensure that abrasion and mechanical shock are minimized.

单击下面可查看定价，库存，交付和生命周期等信息

[>>ISND\(华信安\)](#)