

TO:

文件编号

HXA-L40-01(01)

发行日期

2015年12月25日

承认规格书

种类: Ferrite Chip Inductor

系列号: HXCI- F-Series

客户料号: _____

客户承认栏

承认日期

年 月 日

(贵司承认后请签署一份返回华信安电子, 谢谢!)

厦门华信安电子科技有限公司技术质量部

承认	确认	作成
龙梅	梁峰	王亮

TEL: 0592-6301603 FAX: 0592-5205265

Http: www.xmisnd.com

Ferrite Chip Inductor(Lead Free)

HXCI- F-Series

1. Features

- 1.Monolithic inorganic material construction.
- 2.Closed magnetic circuit avoids crosstalk.
- 3.S.M.T. type.
- 4.Suitable for flow and reflow soldering.
- 5.Shapes and dimensions follow E.I.A. spec.
- 6.Available in various sizes.
- 7.Excellent solderability and heat resistance.
- 8.High reliability.
- 9.This component is compliant with RoHS legislation and also support lead-free soldering.

2. Dimension

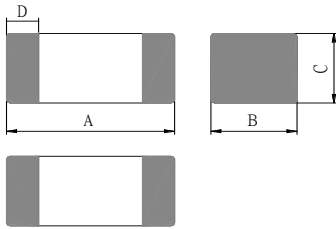

Chip size				
Size	A(mm)	B(mm)	C(mm)	D(mm)
1608	1.6±0.15	0.8±0.15	0.8±0.15	0.3±0.2
	1.8±0.15			
2012	2.0±0.2	1.25±0.2	0.85±0.2	0.5±0.3
			1.25±0.2	
2520	2.5±0.2	2.0±0.2	1.6±0.2	0.5±0.3
3216	3.2±0.2	1.6±0.2	1.1±0.3	0.5±0.3
3225	3.2±0.2	2.5±0.2	1.3±0.2	0.5±0.3
4532	4.5±0.2	3.2±0.2	1.5±0.2	0.5±0.3

3. Part Numbering

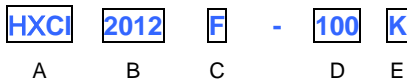

- A: Series
 B: Dimension
 C: Material
 D: Inductance
 E: Inductance Tolerance
- L x W
 Lead Free Material
 100=10.0uH
 K=±10%, J=±5%, L=±15%, M=±20%, N=±25%

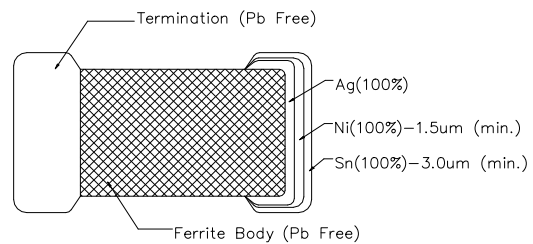

4.Specification

ISND Part Number	Thickness C size (mm)	Inductance (uH)	Q min.	Test Frequency (MHz)	Rated Current (mA)	DC Resistance (Ohm) max.	SRF (MHz) min.
HXCI1608F-47N□	0.8±0.15	0.047	10	50	50	0.30	260
HXCI1608F-68N□	0.8±0.15	0.068	10	50	50	0.30	250
HXCI1608F-82N□	0.8±0.15	0.082	10	50	50	0.30	245
HXCI1608F-R10□	0.8±0.15	0.10	15	25	50	0.50	240
HXCI1608FR12□	0.8±0.15	0.12	15	25	50	0.50	205
HXCI1608F-R15□	0.8±0.15	0.15	15	25	50	0.60	180
HXCI1608F-R18□	0.8±0.15	0.18	15	25	50	0.60	165
HXCI1608F-R22□	0.8±0.15	0.22	15	25	50	0.80	150
HXCI1608F-R27□	0.8±0.15	0.27	15	25	50	0.80	136
HXCI1608F-R33□	0.8±0.15	0.33	15	25	35	0.85	125
HXCI1608F-R39□	0.8±0.15	0.39	15	25	35	1.00	110
HXCI1608F-R47□	0.8±0.15	0.47	15	25	35	1.35	105
HXCI1608F-R56□	0.8±0.15	0.56	15	25	35	1.55	95
HXCI1608F-R68□	0.8±0.15	0.68	15	25	35	1.70	80
HXCI1608F-R82□	0.8±0.15	0.82	15	25	35	2.10	75
HXCI1608F-1R0□	0.8±0.15	1.0	30	10	25	0.60	70
HXCI1608F-1R2□	0.8±0.15	1.2	30	10	25	0.80	60

TOLERANCE J: +/-5% K: +/-10% L: +/-15% M: +/-20%.

ISND Part Number	Thickness C size (mm)	Inductance (uH)	Q min.	Test Frequency (MHz)	Rated Current (mA)	DC Resistance (Ohm) max.	SRF (MHz) min.
HXCI1608F-1R5□	0.8±0.15	1.5	30	10	25	0.80	55
HXCI1608F-1R8□	0.8±0.15	1.8	30	10	25	0.95	50
HXCI1608F-2R2□	0.8±0.15	2.2	30	10	15	1.15	45
HXCI1608F-2R7□	0.8±0.15	2.7	30	10	15	1.35	40
HXCI1608F-3R3□	0.8±0.15	3.3	30	10	15	1.55	38
HXCI1608F-3R9□	0.8±0.15	3.9	30	10	15	1.70	36
HXCI1608F-4R7□	0.8±0.15	4.7	30	10	15	2.10	33
HXCI1608TF-5R6□	0.8±0.15	5.6	30	4	15	1.55	22
HXCI1608TF-6R8□	0.8±0.15	6.8	30	4	15	1.70	20
HXCI1608TF-8R2□	0.8±0.15	8.2	30	4	15	2.10	18
HXCI1608TF-100□	0.8±0.15	10.0	30	2	15	2.55	17
HXCI1608TF-120□	0.8±0.15	12.0	30	2	15	2.75	15
HXCI1608TF-150□	0.8±0.15	15.0	20	1	15	1.70	14
HXCI1608TF-180□	0.8±0.15	18.0	20	1	15	1.85	13
HXCI2012F-47N□	0.85±0.2	0.047	15	50	300	0.20	320
HXCI2012F-68N□	0.85±0.2	0.068	15	50	300	0.20	280
HXCI2012F-82N□	0.85±0.2	0.082	15	50	300	0.20	255
HXCI2012F-R10□	0.85±0.2	0.10	20	25	250	0.30	235
HXCI2012F-R12□	0.85±0.2	0.12	20	25	250	0.30	220
HXCI2012F-R15□	0.85±0.2	0.15	20	25	250	0.40	200
HXCI2012F-R18□	0.85±0.2	0.18	20	25	250	0.40	185
HXCI2012F-R22□	0.85±0.2	0.22	20	25	250	0.50	170
HXCI2012F-R27□	0.85±0.2	0.27	20	25	250	0.50	150
HXCI2012F-R33□	0.85±0.2	0.33	20	25	250	0.55	145
HXCI2012F-R39□	0.85±0.2	0.39	25	25	200	0.65	135
HXCI2012F-R47□	1.25±0.2	0.47	25	25	200	0.65	125
HXCI2012F-R56□	1.25±0.2	0.56	25	25	150	0.75	115
HXCI2012F-R68□	1.25±0.2	0.68	25	25	150	0.80	105
HXCI2012F-R82□	1.25±0.2	0.82	25	25	150	1.00	100
HXCI2012F-1R0□	0.85±0.2	1.0	45	10	50	0.40	75
HXCI2012F-1R2□	0.85±0.2	1.2	45	10	50	0.50	65
HXCI2012F-1R5□	0.85±0.2	1.5	45	10	50	0.50	60
HXCI2012F-1R8□	0.85±0.2	1.8	45	10	50	0.60	55
HXCI2012F-2R2□	0.85±0.2	2.2	45	10	30	0.65	50
HXCI2012F-2R7□	1.25±0.2	2.7	45	10	30	0.75	45
HXCI2012F-3R3□	1.25±0.2	3.3	45	10	30	0.80	41
HXCI2012F-3R9□	1.25±0.2	3.9	45	10	30	0.90	38
HXCI2012F-4R7□	1.25±0.2	4.7	45	10	30	1.00	35
HXCI2012F-5R6□	1.25±0.2	5.6	45	4	15	0.90	32
HXCI2012F-6R8□	1.25±0.2	6.8	45	4	15	1.00	29
HXCI2012F-8R2□	1.25±0.2	8.2	45	4	15	1.10	26
HXCI2012F-100□	1.25±0.2	10.0	45	2	15	1.15	24
HXCI2012F-120□	1.25±0.2	12.0	45	2	15	1.25	22
HXCI2012F-150□	1.25±0.2	15.0	30	1	5	0.80	19
HXCI2012F-180□	1.25±0.2	18.0	30	1	5	0.90	18

TOLERANCE J: +/-5% K: +/-10% L: +/-15% M: +/-20%.

ISND Part Number	Thickness C size (mm)	Inductance (uH)	Q min.	Test Frequency (MHz)	Rated Current (mA)	DC Resistance (Ohm) max.	SRF (MHz) min.
HXCI2012F-220□	1.25±0.2	22.0	30	1	5	1.10	16
HXCI2012F-270□	1.25±0.2	27.0	30	1	5	1.15	14
HXCI2012F-330□	1.25±0.2	33.0	30	0.4	5	1.25	13
HXCI2012F-470□	1.25±0.2	47.0	35	2	4	3.00	7.5
HXCI2520F-R10□	1.6±0.3	0.10	30	25.2	450	0.21	680
HXCI2520F-R12□	1.6±0.3	0.12	30	25.2	400	0.22	650
HXCI2520F-R15□	1.6±0.3	0.15	30	25.2	400	0.25	530
HXCI2520F-R18□	1.6±0.3	0.18	30	25.2	370	0.29	520
HXCI2520F-R22□	1.6±0.3	0.22	30	25.2	370	0.30	390
HXCI2520F-R27□	1.6±0.3	0.27	30	25.2	350	0.33	330
HXCI2520F-R33□	1.6±0.3	0.33	30	25.2	350	0.39	310
HXCI2520F-R39□	1.6±0.3	0.39	30	25.2	320	0.40	290
HXCI2520F-R47□	1.6±0.3	0.47	30	25.2	300	0.44	240
HXCI2520F-R56□	1.6±0.3	0.56	30	25.2	250	0.49	210
HXCI2520F-R68□	1.6±0.3	0.68	30	25.2	250	0.52	180
HXCI2520F-R82□	1.6±0.3	0.82	30	25.2	200	0.61	155
HXCI2520F-1R0□	1.6±0.3	1.0	30	7.96	150	0.75	140
HXCI2520F-1R2□	1.6±0.3	1.2	30	7.96	120	0.87	135
HXCI2520F-1R5□	1.6±0.3	1.5	30	7.96	110	1.00	130
HXCI2520F-1R8□	1.6±0.3	1.8	30	7.96	100	1.10	120
HXCI2520F-2R2□	1.6±0.3	2.2	30	7.96	100	1.30	105
HXCI2520F-2R7□	1.6±0.3	2.7	30	7.96	100	1.40	90
HXCI2520F-3R3□	1.6±0.3	3.3	30	7.96	80	1.60	80
HXCI2520F-3R9□	1.6±0.3	3.9	30	7.96	80	1.70	75
HXCI2520F-4R7□	1.6±0.3	4.7	30	7.96	80	1.90	65
HXCI2520F-5R6□	1.6±0.3	5.6	30	7.96	80	2.20	60
HXCI2520F-6R8□	1.6±0.3	6.8	30	7.96	70	2.40	55
HXCI2520F-8R2□	1.6±0.3	8.2	30	7.96	50	2.60	50
HXCI2520F-100□	1.6±0.3	10.0	25	2.52	30	2.20	30
HXCI2520F-120□	1.6±0.3	12.0	25	2.52	20	2.50	27
HXCI2520F-150□	1.6±0.3	15.0	25	2.52	20	2.80	23
HXCI2520F-180□	1.6±0.3	18.0	25	2.52	20	3.20	22
HXCI2520F-220□	1.6±0.3	22.0	25	2.52	20	3.60	21
HXCI2520F-270□	1.6±0.3	27.0	25	2.52	15	4.30	19
HXCI2520F-330□	1.6±0.3	33.0	25	2.52	15	4.70	17
HXCI3216F-47N□	1.1±0.3	0.047	20	50	300	0.15	320
HXCI3216F-68N□	1.1±0.3	0.068	20	50	300	0.25	280
HXCI3216F-R10□	1.1±0.3	0.10	20	25	250	0.25	235
HXCI3216F-R12□	1.1±0.3	0.12	20	25	250	0.30	220
HXCI3216F-R15□	1.1±0.3	0.15	20	25	250	0.30	200
HXCI3216F-R18□	1.1±0.3	0.18	20	25	250	0.40	185
HXCI3216F-R22□	1.1±0.3	0.22	20	25	250	0.40	170
HXCI3216F-R27□	1.1±0.3	0.27	20	25	250	0.50	150
HXCI3216F-R33□	1.1±0.3	0.33	20	25	250	0.50	145
HXCI3216F-R39□	1.1±0.3	0.39	25	25	250	0.60	135
HXCI3216F-R47□	1.1±0.3	0.47	25	25	200	0.60	125

TOLERANCE J: +/-5% K: +/-10% L: +/-15% M: +/-20%.

ISND Part Number	Thickness C size (mm)	Inductance (uH)	Q min.	Test Frequency (MHz)	Rated Current (mA)	DC Resistance (Ohm) max.	SRF (MHz) min.
HXCI3216F-R56□	1.1±0.3	0.56	25	25	200	0.70	115
HXCI3216F-R68□	1.1±0.3	0.68	25	25	150	0.80	105
HXCI3216F-R82□	1.1±0.3	0.82	25	25	150	0.90	100
HXCI3216F-1R0□	1.1±0.3	1.0	45	10	100	0.40	75
HXCI3216F-1R2□	1.1±0.3	1.2	45	10	100	0.50	65
HXCI3216F-1R5□	1.1±0.3	1.5	45	10	50	0.50	60
HXCI3216F-1R8□	1.1±0.3	1.8	45	10	50	0.50	55
HXCI3216F-2R2□	1.1±0.3	2.2	45	10	50	0.60	50
HXCI3216F-2R7□	1.1±0.3	2.7	45	10	50	0.60	45
HXCI3216F-3R3□	1.1±0.3	3.3	45	10	50	0.70	41
HXCI3216F-3R9□	1.1±0.3	3.9	45	10	50	0.80	38
HXCI3216F-4R7□	1.1±0.3	4.7	45	10	50	0.90	35
HXCI3216F-5R6□	1.1±0.3	5.6	50	4	25	0.70	32
HXCI3216F-6R8□	1.1±0.3	6.8	50	4	25	0.80	29
HXCI3216F-8R2□	1.1±0.3	8.2	50	4	25	0.90	26
HXCI3216F-100□	1.1±0.3	10.0	50	2	25	1.00	24
HXCI3216F-120□	1.1±0.3	12.0	50	2	15	1.05	22
HXCI3216F-150□	1.1±0.3	15.0	35	1	5	0.70	19
HXCI3216F-180□	1.1±0.3	18.0	35	1	5	0.70	18
HXCI3216F-220□	1.1±0.3	22.0	35	1	5	0.90	16
HXCI3216F-270□	1.1±0.3	27.0	35	1	5	0.90	14
HXCI3216F-330□	1.1±0.3	33.0	35	0.4	5	1.05	13
HXCI3225F-R12□	1.3±0.2	0.12	30	25.2	450	0.22	500
HXCI3225F-R15□	1.3±0.2	0.15	30	25.2	450	0.25	450
HXCI3225F-R18□	1.3±0.2	0.18	30	25.2	420	0.28	380
HXCI3225F-R22□	1.3±0.2	0.22	30	25.2	420	0.32	350
HXCI3225F-R27□	1.3±0.2	0.27	30	25.2	420	0.36	260
HXCI3225F-R33□	1.3±0.2	0.33	30	25.2	400	0.40	220
HXCI3225F-R39□	1.3±0.2	0.39	30	25.2	400	0.45	200
HXCI3225F-R47□	1.3±0.2	0.47	30	25.2	370	0.50	180
HXCI3225F-R56□	1.3±0.2	0.56	30	25.2	320	0.55	150
HXCI3225F-R68□	1.3±0.2	0.68	30	25.2	300	0.60	140
HXCI3225F-R82□	1.3±0.2	0.82	30	25.2	280	0.65	130
HXCI3225F-1R0□	1.3±0.2	1.0	30	7.96	200	0.70	120
HXCI3225F-1R2□	1.3±0.2	1.2	30	7.96	150	0.75	100
HXCI3225F-1R5□	1.3±0.2	1.5	30	7.96	150	0.85	85
HXCI3225F-1R8□	1.3±0.2	1.8	30	7.96	150	0.90	80
HXCI3225F-2R2□	1.3±0.2	2.2	30	7.96	150	1.00	75
HXCI3225F-2R7□	1.3±0.2	2.7	30	7.96	120	1.10	70
HXCI3225F-3R3□	1.3±0.2	3.3	30	7.96	120	1.20	60
HXCI3225F-3R9□	1.3±0.2	3.9	30	7.96	120	1.30	55
HXCI3225F-4R7□	1.3±0.2	4.7	30	7.96	120	1.50	50
HXCI3225F-5R6□	1.3±0.2	5.6	30	7.96	120	1.60	47
HXCI3225F-6R8□	1.3±0.2	6.8	30	7.96	100	1.80	43
HXCI3225F-8R2□	1.3±0.2	8.2	30	7.96	90	2.00	40

TOLERANCE J: +/-5% K: +/-10% L: +/-15% M: +/-20%.

ISND Part Number	Thickness C size (mm)	Inductance (uH)	Q min.	Test Frequency (MHz)	Rated Current (mA)	DC Resistance (Ohm) max.	SRF (MHz) min.
HXCI3225F-100□	1.3±0.2	10.0	30	2.52	45	2.10	36
HXCI3225F-120□	1.3±0.2	12.0	30	2.52	45	2.50	33
HXCI3225F-150□	1.3±0.2	15.0	30	2.52	35	2.80	30
HXCI3225F-180□	1.3±0.2	18.0	30	2.52	35	3.30	27
HXCI3225F-220□	1.3±0.2	22.0	30	2.52	35	3.70	25
HXCI3225F-270□	1.3±0.2	27.0	30	2.52	15	5.00	20
HXCI3225F-330□	1.3±0.2	33.0	30	2.52	15	5.60	17
HXCI4532F-R10□	1.5±0.2	0.10	35	25.2	700	0.18	300
HXCI4532F-R12□	1.5±0.2	0.12	35	25.2	670	0.20	250
HXCI4532F-R15□	1.5±0.2	0.15	35	25.2	670	0.22	180
HXCI4532F-R18□	1.5±0.2	0.18	35	25.2	670	0.24	140
HXCI4532F-R22□	1.5±0.2	0.22	40	25.2	640	0.25	120
HXCI4532F-R27□	1.5±0.2	0.27	40	25.2	605	0.26	105
HXCI4532F-R33□	1.5±0.2	0.33	40	25.2	575	0.28	100
HXCI4532F-R39□	1.5±0.2	0.39	40	25.2	545	0.30	95
HXCI4532F-R47□	1.5±0.2	0.47	40	25.2	510	0.32	90
HXCI4532F-R56□	1.5±0.2	0.56	40	25.2	480	0.36	85
HXCI4532F-R68□	1.5±0.2	0.68	40	25.2	445	0.40	80
HXCI4532F-R82□	1.5±0.2	0.82	40	25.2	415	0.45	75
HXCI4532F-1R0□	1.5±0.2	1.0	50	7.96	370	0.50	70
HXCI4532F-1R2□	1.5±0.2	1.2	50	7.96	300	0.55	60
HXCI4532F-1R5□	1.5±0.2	1.5	50	7.96	300	0.60	54
HXCI4532F-1R8□	1.5±0.2	1.8	50	7.96	300	0.65	50
HXCI4532F-2R2□	1.5±0.2	2.2	50	7.96	250	0.70	46
HXCI4532F-2R7□	1.5±0.2	2.7	50	7.96	170	0.75	43
HXCI4532F-3R3□	1.5±0.2	3.3	50	7.96	160	0.80	40
HXCI4532F-3R9□	1.5±0.2	3.9	50	7.96	160	0.90	35
HXCI4532F-4R7□	1.5±0.2	4.7	50	7.96	150	1.00	32
HXCI4532F-5R6□	1.5±0.2	5.6	50	7.96	150	1.10	30
HXCI4532F-6R8□	1.5±0.2	6.8	50	7.96	120	1.20	27
HXCI4532F-8R2□	1.5±0.2	8.2	50	7.96	100	1.40	25
HXCI4532F-100□	1.5±0.2	10.0	50	2.52	65	1.60	20
HXCI4532F-120□	1.5±0.2	12.0	50	2.52	60	2.00	18
HXCI4532F-150□	1.5±0.2	15.0	50	2.52	55	2.50	17
HXCI4532F-180□	1.5±0.2	18.0	50	2.52	45	2.80	15
HXCI4532F-220□	1.5±0.2	22.0	50	2.52	45	3.20	13
HXCI4532F-270□	1.5±0.2	27.0	50	2.52	40	3.60	12
HXCI4532F-330□	1.5±0.2	33.0	50	2.52	40	4.00	11

TOLERANCE J: +/-5% K: +/-10% L: +/-15% M: +/-20%.

5. Reliability and Test Condition

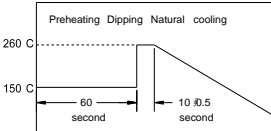
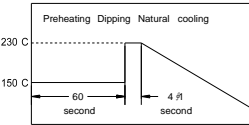
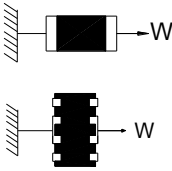
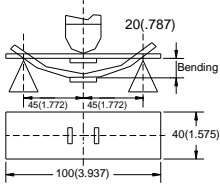
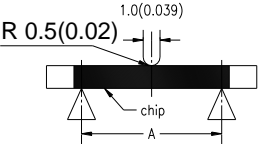
Item	Performance										Test Condition																																										
Series No.	HXCB	HXCM	HXCB	HXPB	HXFB	HXCA	HXCI	HXHI	HXCH	HXCI	--																																										
Operating Temperature	-55~+125°C					-40~+85°C					--																																										
Storage Temperature	-55~+125°C					-40~+85°C					--																																										
Impedance (Z)	Refer to standard electrical characteristics list										HP4291A, HP4287A+16092A																																										
Inductance (Ls)																																																					
Q Factor																																																					
DC Resistance																																																					
Rated Current																																																					
Temperature Rise Test	30°C max. (ΔT)										1. Applied the allowed DC current. 2. Temperature measured by digital surface thermometer.																																										
Solder heat Resistance	Appearance: No significant abnormality. Impedance change: Within $\pm 30\%$.				No mechanical damage. Remaining terminal electrode: 70% min.						Preheat: 150°C, 60sec. Solder: Sn-Ag3.0-Cu0.5 Solder temperature: 260 \pm 5°C Flux for lead free: rosin Dip time: 10 \pm 0.5sec. 																																										
Solderability	More than 90% of the terminal electrode should be covered with solder.										Preheat: 150°C, 60sec. Solder: Sn-Ag3.0-Cu0.5 Solder temperature: 230 \pm 5°C Flux for lead free: rosin Dip time: 4 \pm 1sec.																																										
Terminal strength	The terminal electrode and the dielectric must not be damaged by the forces applied on the right conditions.										 <table border="1"> <thead> <tr> <th colspan="3">For HXCB HXCM</th> </tr> <tr> <th colspan="3">HXCI:</th> </tr> <tr> <th>Size</th> <th>Force (Kgf)</th> <th>Time(sec)</th> </tr> </thead> <tbody> <tr> <td>1005</td> <td>0.2</td> <td></td> </tr> <tr> <td>1608</td> <td>0.5</td> <td></td> </tr> <tr> <td>2012</td> <td>0.6</td> <td></td> </tr> <tr> <td>3216</td> <td>1.0</td> <td>>25</td> </tr> <tr> <td>3225</td> <td>1.0</td> <td></td> </tr> <tr> <td>4516</td> <td>1.0</td> <td></td> </tr> <tr> <td>4532</td> <td>1.5</td> <td></td> </tr> <tr> <td>5750</td> <td>2.0</td> <td></td> </tr> </tbody> </table> <table border="1"> <thead> <tr> <th colspan="3">For FCA:</th> </tr> <tr> <th>Size</th> <th>Force (Kgf)</th> <th>Time(sec)</th> </tr> </thead> <tbody> <tr> <td>3216</td> <td>0.5</td> <td>>25</td> </tr> </tbody> </table>	For HXCB HXCM			HXCI:			Size	Force (Kgf)	Time(sec)	1005	0.2		1608	0.5		2012	0.6		3216	1.0	>25	3225	1.0		4516	1.0		4532	1.5		5750	2.0		For FCA:			Size	Force (Kgf)	Time(sec)	3216	0.5	>25
For HXCB HXCM																																																					
HXCI:																																																					
Size	Force (Kgf)	Time(sec)																																																			
1005	0.2																																																				
1608	0.5																																																				
2012	0.6																																																				
3216	1.0	>25																																																			
3225	1.0																																																				
4516	1.0																																																				
4532	1.5																																																				
5750	2.0																																																				
For FCA:																																																					
Size	Force (Kgf)	Time(sec)																																																			
3216	0.5	>25																																																			
Flexure strength	The terminal electrode and the dielectric must not be damaged by the forces applied on the right conditions.										 <p>Solder a chip on a test substrate, bend the substrate by 2mm (0.079in) and return.</p>																																										
Bending Strength	The ferrite should not be damaged by Forces applied on the right condition.										 <table border="1"> <thead> <tr> <th>Size</th> <th>mm(inches)</th> <th>P-Kgf</th> </tr> </thead> <tbody> <tr> <td>1608</td> <td>0.80(0.033)</td> <td>0.3</td> </tr> <tr> <td>2012</td> <td>1.40(0.055)</td> <td>1.0</td> </tr> <tr> <td>3216</td> <td>2.00(0.079)</td> <td>2.5</td> </tr> <tr> <td>3225</td> <td></td> <td></td> </tr> <tr> <td>4516</td> <td>2.70(0.106)</td> <td>2.5</td> </tr> <tr> <td>4532</td> <td></td> <td></td> </tr> <tr> <td>5750</td> <td></td> <td></td> </tr> </tbody> </table>	Size	mm(inches)	P-Kgf	1608	0.80(0.033)	0.3	2012	1.40(0.055)	1.0	3216	2.00(0.079)	2.5	3225			4516	2.70(0.106)	2.5	4532			5750																				
Size	mm(inches)	P-Kgf																																																			
1608	0.80(0.033)	0.3																																																			
2012	1.40(0.055)	1.0																																																			
3216	2.00(0.079)	2.5																																																			
3225																																																					
4516	2.70(0.106)	2.5																																																			
4532																																																					
5750																																																					
Random Vibration Test	Appearance: Cracking, shipping and any other defects harmful to the characteristics should not be allowed. Impedance: within $\pm 30\%$										Frequency: 10-55-10Hz for 1 min. Amplitude: 1.52mm Directions and times: X, Y, Z directions for 2 hours. A period of 2 hours in each of 3 mutually perpendicular directions (Total 6 hours).																																										
Drop	Drop 10 times on a concrete floor from a height of 75cm										a: No mechanical damage b: Impedance change: $\pm 30\%$																																										

Item	Performance	Test Condition																		
Loading at High Temperature	Appearance: no damage.	Temperature: 125±5°C (bead), 85±5°C (inductor) Applied current: rated current. Duration: 500±12hrs. Measured at room temperature after placing for 2 to 3hrs.																		
Humidity	Impedance: within±30% of initial value. Inductance: within±10% of initial value. Q: within±30% of initial value. (FCI FHI FCH) Q: within±20% of initial value. (HCI)	Humidity: 90-95%RH. Temperature: 40±2°C. Temperature: 60±2°C. (HCI) Duration: 500±12hrs. Measured at room temperature after placing for 2 to 3hrs.																		
Thermal shock	Appearance: no damage. Impedance: within±30% of initial value. Inductance: within±10% of initial value. Q: within±30% of initial value. (FCI FHI FCH) Q: within±20% of initial value. (HCI)	For FCB FCM HCB HPB HFB FCA : Condition for 1 cycle Step1: -55±2°C 30±3 min. Step2: +125±5°C 30±3 min. Number of cycles: 5 For FCI FHI FCH HCI : Condition for 1 cycle Step1: -40±2°C 30±3 min. Step2: +85±5°C 30±3 min. Number of cycles: 100 Measured at room temperature after placing for 2 to 3 hrs.																		
Low temperature storage test	For Bead : <table border="1"> <thead> <tr> <th>Phase</th> <th>Temperature(°C)</th> <th>Time(min.)</th> </tr> </thead> <tbody> <tr> <td>1</td> <td>-55±2°C</td> <td>30±3</td> </tr> <tr> <td>2</td> <td>+125±5°C</td> <td>30±3</td> </tr> </tbody> </table> Measured: 5 times For Inductor : <table border="1"> <thead> <tr> <th>Phase</th> <th>Temperature(°C)</th> <th>Time(min.)</th> </tr> </thead> <tbody> <tr> <td>1</td> <td>-40±2°C</td> <td>30±3</td> </tr> <tr> <td>2</td> <td>+85±5°C</td> <td>30±3</td> </tr> </tbody> </table> Measured: 100 times	Phase	Temperature(°C)	Time(min.)	1	-55±2°C	30±3	2	+125±5°C	30±3	Phase	Temperature(°C)	Time(min.)	1	-40±2°C	30±3	2	+85±5°C	30±3	For FCB FCM HCB HPB HFB FCA : Condition for 1 cycle Step1: -55±2°C 30±3 min. Step2: +125±5°C 30±3 min. Number of cycles: 5 For FCI FHI FCH HCI : Condition for 1 cycle Step1: -40±2°C 30±3 min. Step2: +85±5°C 30±3 min. Number of cycles: 100 Measured at room temperature after placing for 2 to 3 hrs.
Phase	Temperature(°C)	Time(min.)																		
1	-55±2°C	30±3																		
2	+125±5°C	30±3																		
Phase	Temperature(°C)	Time(min.)																		
1	-40±2°C	30±3																		
2	+85±5°C	30±3																		
Drop	Drop 10 times on a concrete floor from a height of 75cm	a: No mechanical damage b: Impedance change: ±30%																		

****Derating Curve**

For the ferrite chip bead which withstanding current over 1.5A, as the operating temperature over 85°C, the derating current information is necessary to consider with. For the detail derating of current, please refer to the Derated Current vs. Operating Temperature curve.

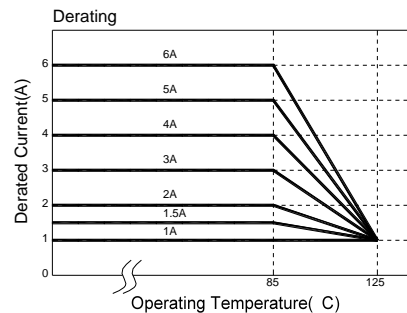

6.Soldering and Mounting

6-1. Recommended PC Board Pattern

Chip Size					Land Patterns For Reflow Soldering			
Series	Type	A(mm)	B(mm)	C(mm)	D(mm)	L(mm)	G(mm)	H(mm)
HXCM	1608	1.6±0.15	0.80±0.15	0.80±0.15	0.30±0.20	2.60	0.60	0.80
HXCB	2012	2.0±0.20	1.25±0.20	0.85±0.20	0.50±0.30	3.00	1.00	1.00
HXCI	3216	3.2±0.20	1.60±0.20	1.10±0.20	0.50±0.30	4.40	2.20	1.40

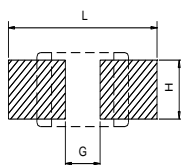

PC board should be designed so that products are not sufficient under mechanical stress as warping the board. Products shall be positioned in the sideway direction against the mechanical stress to prevent failure.

6-2. Soldering

Mildly activated rosin fluxes are preferred. The minimum amount of solder can lead to damage from the stresses caused by the difference in coefficients of expansion between solder, chip and substrate. The terminations are suitable for all wave and re-flow soldering systems. If hand soldering cannot be avoided, the preferred technique is the utilization of hot air soldering tools.

6-2.1 Lead Free Solder re-flow:

Recommended temperature profiles for lead free re-flow soldering in Figure 1.

6-2.2 Solder Wave:

Wave soldering is perhaps the most rigorous of surface mount soldering processes due to the steep rise in temperature seen by the circuit when immersed in the molten solder wave, typical at 230°C. Due to the risk of thermal damage to products, wave soldering of large size products is discouraged. Recommended temperature profile for wave soldering is shown in Figure 2.

6-2.3 Soldering Iron(Figure 3):

Products attachment with a soldering iron is discouraged due to the inherent process control limitations. In the event that a soldering iron must be employed the following precautions are recommended.

- Note : · Preheat circuit and products to 150°C
- 350°C tip temperature for Ferrite chip bead (max)
- Never contact the ceramic with the iron tip
- 1.0mm tip diameter (max)
- Use a 20 watt soldering iron with tip diameter of 1.0mm
- Limit soldering time to 3 sec.

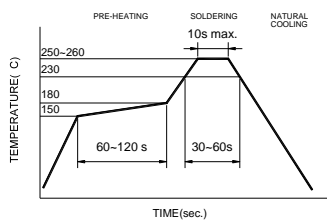

Figure 1. Re-flow Soldering(Lead Free)

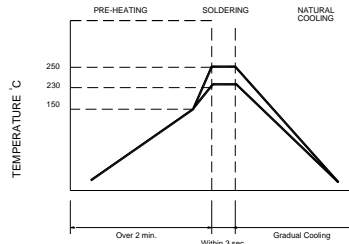

Figure 2. Wave Soldering

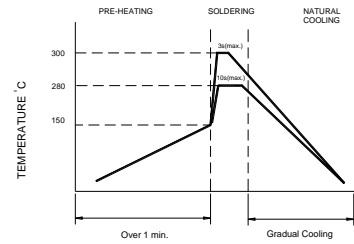
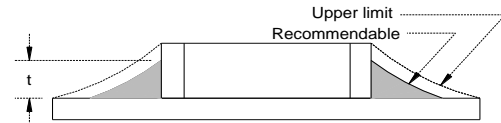

Figure 3. Hand Soldering

6-2.4 Solder Volume:

Accordingly increasing the solder volume, the mechanical stress to product is also increased. Exceeding solder volume may cause the failure of mechanical or electrical performance. Solder shall be used not to be exceed as shown in right side:



7.Packaging Information

7-1. Reel Dimension

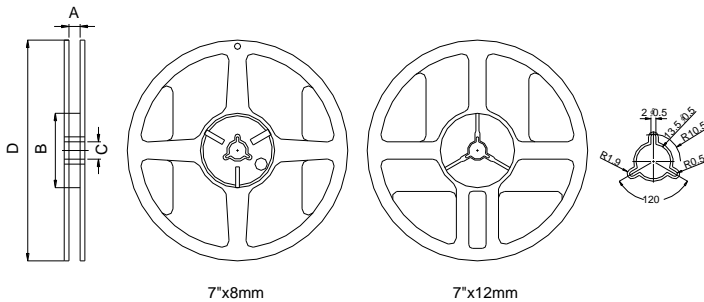

Type	A(mm)	B(mm)	C(mm)	D(mm)
7"×8mm	9.0±0.5	60±2	13.5±0.5	178±2
7"×12mm	13.5±0.5	60±2	13.5±0.5	178±2

7-2.1 Tape Dimension / 8mm

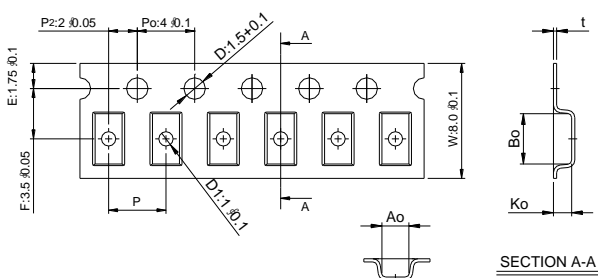

Series	Size	Bo(mm)	Ao(mm)	Ko(mm)	P(mm)	t(mm)	D1(mm)
FCB,FCM	100505	1.12±0.05	0.67±0.05	0.54±0.05	2.0±0.1	0.23±0.05	none
HXCB	160808	1.80±0.10	1.01±0.10	1.02±0.10	4.0±0.1	0.22±0.05	none
HXFB	201209	2.25±0.10	1.42±0.10	1.04±0.10	4.0±0.1	0.22±0.05	1.0±0.1
HXCI	201212	2.35±0.10	1.50±0.10	1.45±0.10	4.0±0.1	0.22±0.05	1.0±0.1

7-2.2 Tape Dimension / 12mm

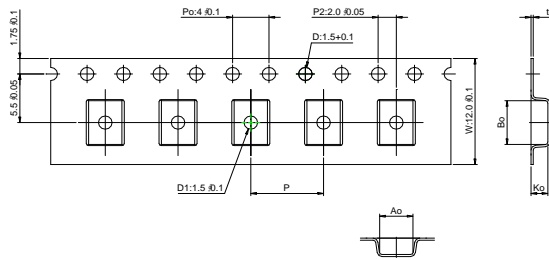

Series	Size	Bo(mm)	Ao(mm)	Ko(mm)	P(mm)	t(mm)	D1(mm)
HXCB	451616	4.95±0.1	1.93±0.1	1.93±0.1	4.0±0.1	0.24±0.05	1.5±0.1
HXCM	453215	4.95±0.1	3.66±0.1	1.85±0.1	8.0±0.1	0.24±0.05	1.5±0.1
HXCI	575018	6.10±0.1	5.40±0.1	2.00±0.1	8.0±0.1	0.30±0.05	1.5±0.1

7-3. Packaging Quantity

Chip Size	575018	453215	451616	322513	321611	201212	201209	160808	100505
Chip / Reel	1000	1000	2000	2500	3000	2000	4000	4000	10000
Inner box	4000	4000	8000	12500	15000	10000	20000	20000	50000
Middle box	20000	20000	40000	62500	75000	50000	100000	100000	250000
Carton	40000	40000	80000	125000	150000	100000	200000	200000	500000
Bulk (Bags)	7000	12000	20000	30000	50000	100000	150000	200000	300000

7-4. Tearing Off Force

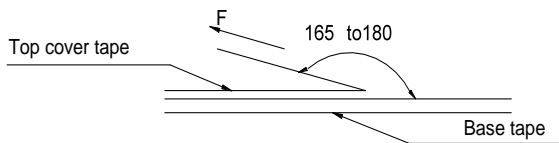

The force for tearing off cover tape is 15 to 60 grams in the arrow direction under the following conditions.

Room Temp. (°C)	Room Humidity (%)	Room atm (hPa)	Tearing Speed mm/min
5~35	45~85	860~1060	300

Application Notice

·Storage Conditions

To maintain the solderability of terminal electrodes:

1. Temperature and humidity conditions: -10~ 40°C and 30~70% RH.
2. Recommended products should be used within 6 months from the time of delivery.
3. The packaging material should be kept where no chlorine or sulfur exists in the air.

·Transportation

1. Products should be handled with care to avoid damage or contamination from perspiration and skin oils.
2. The use of tweezers or vacuum pick up is strongly recommended for individual components.
3. Bulk handling should ensure that abrasion and mechanical shock are minimized.

单击下面可查看定价，库存，交付和生命周期等信息

[>>ISND\(华信安\)](#)