

TO :

文件编号

HXA-L31-01 (02)

发行日期

2019年05月09日

承认规格书

种类：Power Inductor

系列号：HXNR201610TF-Series

客户料号：_____

客户承认栏

承认日期		年	月	日
------	--	---	---	---

(贵司承认后请签署一份返回华信安电子, 谢谢!)

厦门华信安电子科技有限公司技术质量部

承认	确认	作成
龙梅	梁峰	王亮

TEL : 0592-6301603 FAX : 0592-5205265

Http : www.xmisnd.com

Power Inductor

HXNR201610TF-SERIES

1. Features

1. This specification applies Low Profile Power Inductors.
2. 100% Lead(Pb) & Halogen-Free and RoHS compliant.



2. Dimension

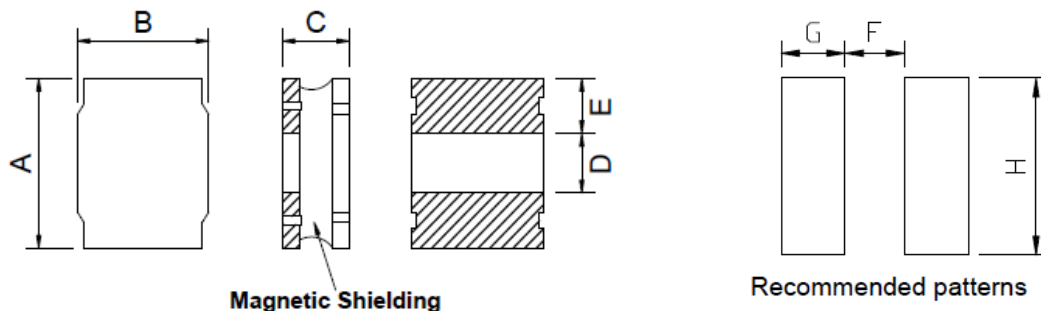

Series	A(mm)	B(mm)	C(mm)	D(mm)	E(mm)	F(mm)	G(mm)	H(mm)
HXNR201610TF	2.0±0.25	1.6±0.25	1.0 max	0.9±0.2	0.6±0.2	0.60	0.80	1.80

3. Part Numbering

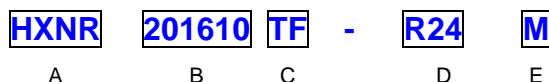

A: Series

B: Dimension

C: Control S/N

D: Inductance

R24=0.24uH

E: Inductance Tolerance

M=±20%

4. Specification

ISND Part Number	Inductance (uH)	Tolerance (%)	Test Frequency (Hz)	DCR (Ω) Typ.	DCR (Ω) Max.	I sat (A) Typ.	I sat (A) Max.	I rms (A) Typ.	I rms (A) Max.
HXNR201610TF-R24M	0.24	±20%	0.1V/1M	0.023	0.028	5.10	4.50	4.40	3.90
HXNR201610TF-R33M	0.33	±20%	0.1V/1M	0.031	0.040	3.90	3.50	3.50	3.10
HXNR201610TF-R47M	0.47	±20%	0.1V/1M	0.035	0.042	3.85	3.40	3.30	3.00
HXNR201610TF-R68M	0.68	±20%	0.1V/1M	0.046	0.055	3.25	2.80	2.80	2.50
HXNR201610TF-1R0M	1.0	±20%	0.1V/1M	0.059	0.072	2.90	2.50	2.40	2.20
HXNR201610TF-1R5M	1.5	±20%	0.1V/1M	0.098	0.118	2.30	1.80	2.10	1.80
HXNR201610TF-2R2M	2.2	±20%	0.1V/1M	0.141	0.170	2.10	1.70	1.70	1.45

Note:

Isat : Based on inductance change ($\Delta L/L0$: $\leq -30\%$) @ ambient temp. 25°CI rms : Based on temperature rise (ΔT : 40°C typ.)

5. Material List

No.	Description	Specification
a.	Core	Ferrite N4 Core
b.	Coating	Epoxy
c.	Termination	Tin Pb Free
d.	Wire	Enameled Copper Wire

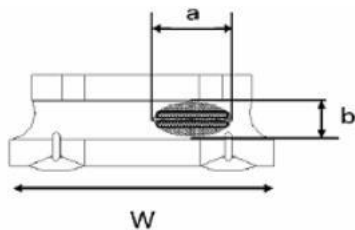
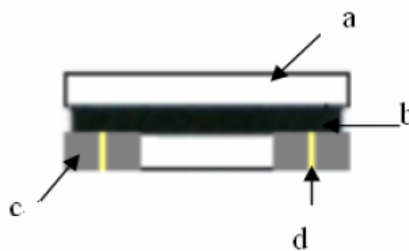

Exposed wire tolerance limit of coating resin part on product side.

Size of exposed wire occurring to coating resin is specified below.

1. Width direction (dimension a) : Acceptable when $a \leq w/2$
Nonconforming when $a > w/2$
2. Length direction (dimension b) : Dimension b is not specified.
3. The total area of exposed wire occurring to each sides is not greater than 50% of coating resin area, and is acceptable.

6. Reliability and Test Condition

Item	Performance	Test Condition
Operating Temperature	- 40 ~ +125°C.	Including self-generated heat
Storage Temperature	- 40 ~ +125°C. - 5 to 40°C for the product with taping.	
Rated current	Within the specified tolerance	
Inductance (L)		LCR Meter: HP 4285A or equivalent, 100kHz, 1V
DC Resistance		DC Ohmmeter: HIOKI3227 or equivalent
Temperature characteristics	Inductance change : Within±20%	Measurement of inductance shall be taken at temperature rang within-25°C to +85°C. With reference to inductance value at+20 °C,change rate shall be calculated. Measurement of inductance shall be taken at temperature rang within-40°C to +125°C. With reference to inductance value at+20 °C,change rate shall be calculated.
Resistance to flexure substrate	No damage.	The test samples shall be soldered to the testing board by the reflow. As illustrated below, apply force in the direction of the arrow indicating until deflection of the test board reaches to 2mm. Substrate size : 100x40x1.0 Substrate material : glass epoxy-resin Solder cream thickness : 0.10
Adhesion of Terminal electrode	Shall not come off PC board.	The test samples shall be soldered to the testing board and by the reflow. Applied force : 10 N to X and Y directions. Duration : 5s Solder cream thickness : 0.10
Resistance to Vibration	Inductance change : Within±10% No abnormality observed in appearance.	The test samples shall be soldered to the test board by the reflow. Then it shall be submitted to below test conditions. Frequency: 10-55Hz Total Amplitude: 1.5mm (May not exceed acceleration 196m/S2) Sweeping Method:10Hz to 55Hz to 10Hz for 1min. Time : 2 hours each in X,Y, and Z Direction. Recovery: At least 2hrs of recovery under the standard condition after the test, followed by the measurement within 48hrs.

Solderability	At least 90% of surface of terminal electrode is covered by new solder.	The test samples shall be dipped in flux, and then immersed in molten solder as shown in below. Flux : methanol solution containing rosin 25% Solder temperature: 245±5°C Time: 5±1.0 sec. Immersion depth: All sides of mounting terminal shall be immersed.															
Resistance to soldering	Inductance change : Within±10% No abnormality observed in appearance.	The test sample shall be exposed to reflow oven at 230±5°C for 40 seconds, with peak temperature at 260±5°C for 5 seconds,2 times. Test board thickness: 1.0mm Test board material: glass epoxy-resin															
Item	Performance	Test Condition															
Thermal shock	Inductance change : Within±10% No abnormality observed in appearance.	The test samples shall be soldered to the test board by the reflow. The test samples shall be placed at specified temperature for specified time by step 1 to step 4 as shown below in sequence. The temperature cycles shall be repeated 100 cycles . <table border="1"> <thead> <tr> <th>Phase</th> <th>Temperature(°C)</th> <th>Time(min.)</th> </tr> </thead> <tbody> <tr> <td>1</td> <td>-40±3°C</td> <td>30±3</td> </tr> <tr> <td>2</td> <td>Room Temp</td> <td>Within 3</td> </tr> <tr> <td>3</td> <td>85±2°C</td> <td>30±3</td> </tr> <tr> <td>4</td> <td>Room Temp</td> <td>Within 3</td> </tr> </tbody> </table>	Phase	Temperature(°C)	Time(min.)	1	-40±3°C	30±3	2	Room Temp	Within 3	3	85±2°C	30±3	4	Room Temp	Within 3
Phase		Temperature(°C)	Time(min.)														
1		-40±3°C	30±3														
2		Room Temp	Within 3														
3		85±2°C	30±3														
4		Room Temp	Within 3														
Damp heat life test	Test Method and Remarks The test samples shall be soldered to the test board by the reflow. The test samples shall be placed in thermostatic oven set at specified temperature and humidity as shown in below. Temperature: 60±2°C Humidity: 90~95%RH Time: 500+24/-0 hrs																
Loading under damp heat life test	The test samples shall be soldered to the test board by the reflow. The test samples shall be placed in thermostatic oven set at specified temperature and humidity and applied the rated current continuously as shown in below. Temperature: 60±2°C Humidity: 90~95%RH Applied current: Rated current Time: 500+24/-0 hrs																
Low temperature life test	The test samples shall be soldered to the test board by the reflow. After that, the test samples shall be placed at test conditions as shown in below. Temperature:-40±2°C Time:500+24/-0 hrs																
Loading at high temperature life test	The test samples shall be soldered to the test board by the reflow. Temperature: 85±2°C. Applied current: Rated current Time: 500+24/-0 hrs.																

7. Soldering

7-1. Soldering

7-2. Recommended PC Board Pattern

Mildly activated rosin fluxes are preferred. TAI-TECH terminations are suitable for all wave and re-flow soldering systems.

If hand soldering cannot be avoided, the preferred technique is the utilization of hot air soldering tools.

7-1.1 Solder re-flow:

Recommended temperature profiles for re-flow soldering in Figure 1.

7-1.2 Soldering Iron(Figure 2):

Products attachment with a soldering iron is discouraged due to the inherent process control limitations. In the event that a soldering iron must be employed the following precautions are recommended.

·Preheat circuit and products to 150°C ·Never contact the ceramic with the iron tip ·Use a 20 watt soldering iron with tip diameter of 1.0mm

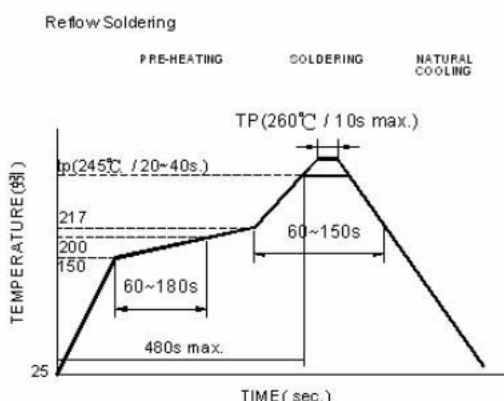

Reflow times: 3 times max.

Fig.1

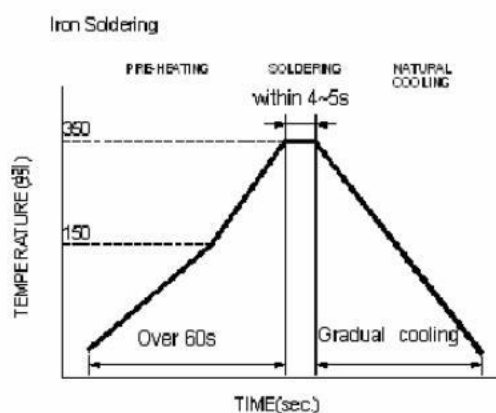

Iron Soldering times: 1 times max.

Fig.2

7-2. Recommended PC Board Pattern

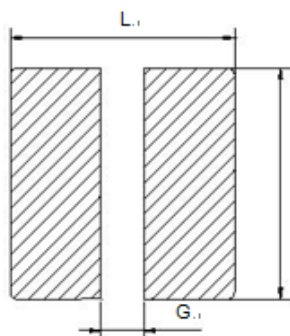

L(mm)	G(mm)	H(mm)
2.3	0.7	1.7

8. Packaging Information

(1) Reel Dimension

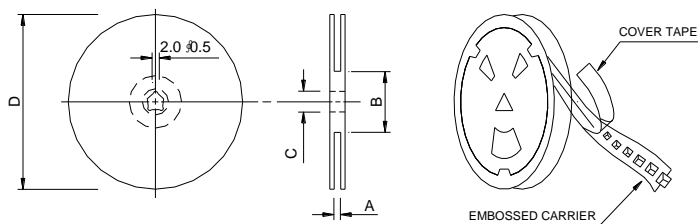

Type	A(mm)	B(mm)	C(mm)	D(mm)
HXNR201610TF	8.4±1.0	50 min	13±0.8	178±2

(2) Tape Dimension

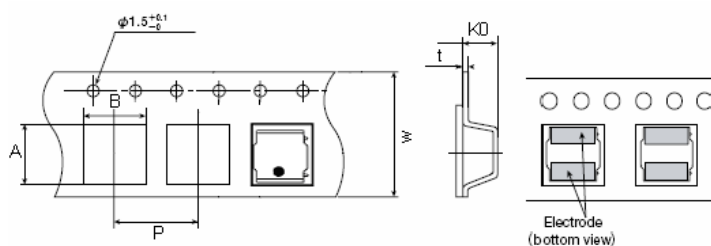

Type	A(mm)	B(mm)	Ko(mm)	P(mm)	W(mm)	t(mm)
HXNR201610TF	2.5±0.1	2.0±0.1	1.4±0.1	4.0±0.1	8.0±0.1	0.23±0.05

(3) Packaging Quantity

Type	Chip / Reel
HXNR201610TF	2000

8-4. Tearing Off Force

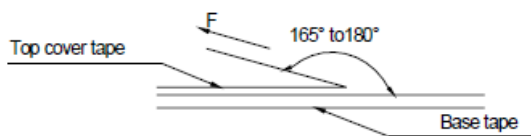

The force for tearing off cover tape is 15 to 80 grams in the arrow direction under the following conditions.

Room Temp. (°C)	Room Humidity (%)	Room atm (hPa)	Tearing Speed mm/min
5~35	45~85	860~1060	300

Application Notice

Storage Conditions

To maintain the solderability of terminal electrodes:

1. ISND products meet IPC/JEDEC J-STD-020D standard-MSL, level 1.
2. Temperature and humidity conditions: Less than 40°C and 60% RH.
3. Recommended products should be used within 12 months from the time of delivery.
4. The packaging material should be kept where no chlorine or sulfur exists in the air.

Transportation

1. Products should be handled with care to avoid damage or contamination from perspiration and skin oils.
2. The use of tweezers or vacuum pick up is strongly recommended for individual components.
3. Bulk handling should ensure that abrasion and mechanical shock are minimized.

单击下面可查看定价，库存，交付和生命周期等信息

[>>ISND\(华信安\)](#)