

产品承认书

SPECIFICATION FOR APPROVAL

版本: REV. A0

客户

Customer

:

客户料号

Customer's P/N

:

品名

Description

:

产品型号

CENKER P/N

:

图纸编号

Drawing No.

:

产品编号

Product code.

:

AXIAL FIXED INDUCTOR

HXL0510 Series

SP-HXA004-S04

出图

DRAWING

制表

审核

批准

Prepared By

Checked By

Approved By

王亮

龙梅

梁峰

DATE

2016-7-29

承认

CUSTOMER APPROVAL

DATE:

厦门华信安电子科技有限公司

XIAMEN SINO FAITH ELECTRONIC TECHNOLOGY CO.,LTD

地址:厦门市翔安区翔岳路25号东北栋

Address: Xiang'an District, Xiamen Xiang Yue Road on the 25th Northeast, China



TEL: 0592-6301603 FAX: 0592-5205265

SPECIFICATION FOR APPROVAL

**RoHS
COMPLIANT**

CUSTOMER		CUSTOMER P/N		PAGE
DESCRIPTION	AXIAL FIXED INDUCTOR	DRAWING No.	SP-HXA004-S04	1
CENKER P/N	HXL0510 Series	ISSUE DATE	2016-7-29	VERSION A0

CONTENTS

NO.	ARTICLE/DETAIL	PAGE
	CONTENTS	1
	MODIFY RECORD	2
1	PRODUCTS IDENTIFICATION	3
2	DIMENSIONS	3
3	CIRCUIT	3
4	TEMPERATURE RANGE	3
5	MARKING	4
6	CONSTRUCTION	4
7	MATERIAL LIST	4
8	ELECTRICAL REQUIREMENTS	5~6
9	TEST EQUIPMENT AND TEST CONDITION	7
10	WARNING FOR LEAD WIRE FORMING	7
11	PACKING	7
12	RELIABILITY	8

SPECIFICATION FOR APPROVAL

**RoHS
COMPLIANT**

CUSTOMER		CUSTOMER P/N		PAGE
DESCRIPTION	AXIAL FIXED INDUCTOR	DRAWING No.	SP-HXA004-S04	2
CENKER P/N	HXL0510 Series	ISSUE DATE	2016-7-29	VERSION A0

MODIFY RECORD

Symbol	Version	Date	Content	Prepared	Checked
	A0	2016-7-29	/		

SPECIFICATION FOR APPROVAL

RoHS
COMPLIANT

CUSTOMER		CUSTOMER P/N		PAGE
DESCRIPTION	AXIAL FIXED INDUCTOR	DRAWING No.	SP-HXA004-S04	3
CENKER P/N	HXL0510 Series	ISSUE DATE	2016-7-29	VERSION
				A0

1. PRODUCTS IDENTIFICATION

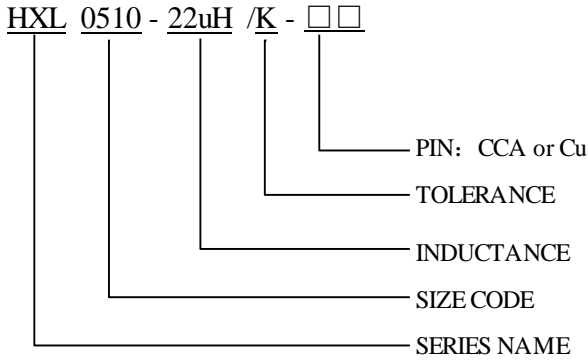

2. DIMENSIONS(UNIT: mm)

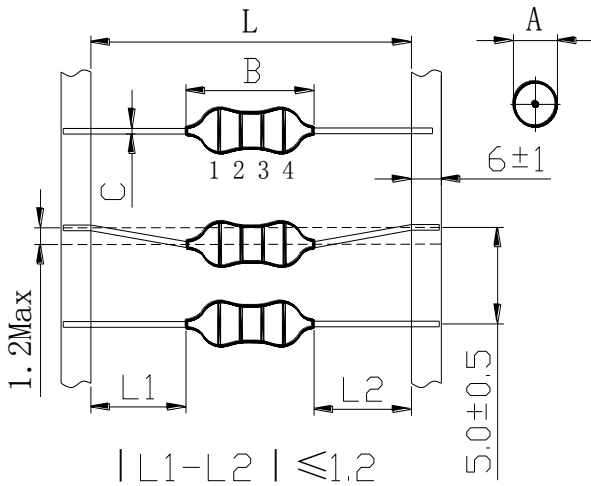

A	Ø5.0 Max
B	11.0 Max
C	Ø0.6±0.1
L	52.4±1.5

***Minimum insertion pitch: 12.5mm**

3. CIRCUIT

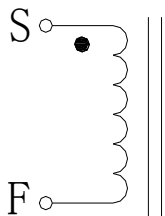

4. TEMPERATURE RANGE

Operating Temperature: -25°C ~ +85°C, Storage Temperature: -25°C ~ +85°C.

厦门华信安电子科技有限公司 XIAMEN SINO FAITH ELECTRONIC TECHNOLOGY CO.,LTD TEL: 0592-6301603 FAX: 0592-5205265 地址:厦门市翔安区翔岳路25号东北栋	PREPARED	CHECKED	APPROVED
	王亮	龙梅	梁峰

SPECIFICATION FOR APPROVAL

RoHS
COMPLIANT

CUSTOMER		CUSTOMER P/N		PAGE
DESCRIPTION	AXIAL FIXED INDUCTOR	DRAWING No.	SP-HXA004-S04	4
CENKER P/N	HXL0510 Series	ISSUE DATE	2016-7-29	VERSION A0

5. MARKING

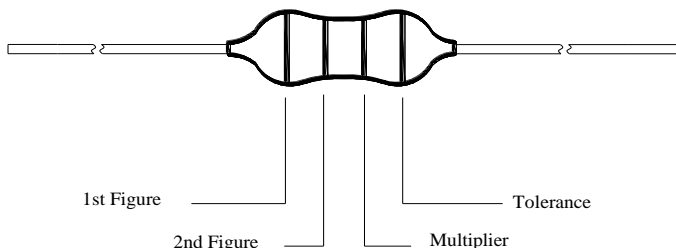

Color	Nominal Inductance(uH)			
	1st Figure	2nd Figure	Multiplier	Tolerance
Black	0		×1	±20%
Brown	1		×10	—
Red	2		×100	—
Orange	3		×1000	—
Yellow	4		—	—
Green	5		—	—
Blue	6		—	—
Violet	7		—	—
Gray	8		—	—
White	9		—	—
Gold	—		×0.1	±5%
Silver	—		×0.01	±10%

6. CONSTRUCTION

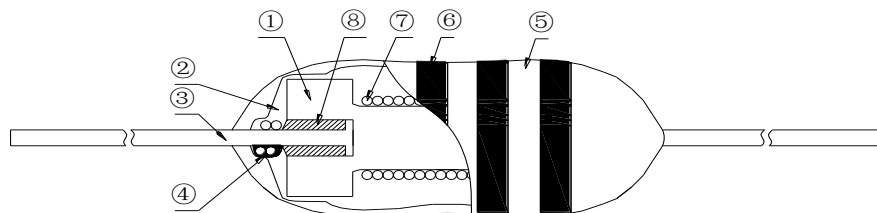

7. MATERIAL LIST

No.	Material	Specification	Supply's name	Remark
1	Core	Ferrite Core DR4.0*6.0	6212/6006	
		Ferrite Core DR4.2*6.0	6001	
2	Under-Coating Resin	BUTADIENE RESIN UV	6051/6102	
3	Pin	CCA Ø0.58mm/Ø0.64mm	6029	
		Cu Ø0.55mm	6029	
4	Solder	Sn99.3-Cu0.7	6050	
5	Over-Coating Resin	EPOXY RESIN	6051/6102	
6	Color-Coating Resin	MELAMINE RESIN	6051/6102	
7	Wire	COPPER WIRE PLATED TIN 100%	6030	UL No.:E344055
8	Glue	J-600	5163	

厦门华信安电子科技有限公司 XIAMEN SINO FAITH ELECTRONIC TECHNOLOGY CO.,LTD		PREPARED	CHECKED	APPROVED
 TEL: 0592-6301603 FAX: 0592-5205265 地址:厦门市翔安区翔岳路25号东北栋		王亮	龙梅	梁峰

SPECIFICATION FOR APPROVAL

**RoHS
COMPLIANT**

CUSTOMER		CUSTOMER P/N		PAGE
DESCRIPTION	AXIAL FIXED INDUCTOR	DRAWING No.	SP-HXA004-S04	5
CENKER P/N	HXL0510 Series	ISSUE DATE	2016-7-29	VERSION
				A0

8. ELECTRICAL REQUIREMENTS

Customer P/N	PART NO.	Inductance (uH)	Inductance Test Freq. [MHz]	Q (Min)	Q Test Freq. [MHz]	DCR [Ω] (Max)	SRF [MHz] (Min)	Rated Current [mA] (Max)
	HXL0510-4.7uH/K	4.7 \pm 10%	7.96	20	7.96	0.06	50	900
	HXL0510-10uH/K	10 \pm 10%	7.96	15	7.96	0.45	30	750
	HXL0510-22uH/K	22 \pm 10%	2.52	30	2.52	0.65	8	450
	HXL0510-82uH/K	82 \pm 10%	2.52	20	2.52	0.82	3.8	330
	HXL0510-100uH/K	100 \pm 10%	2.52	20	2.52	0.75	3.5	300
	HXL0510-120uH/K	120 \pm 10%	0.796	20	0.796	1.2	3.3	250
	HXL0510-150uH/K	150 \pm 10%	0.796	20	0.796	1.8	3.2	225
	HXL0510-180uH/K	180 \pm 10%	0.796	20	0.796	2	2.8	200
	HXL0510-220uH/K	220 \pm 10%	0.796	30	0.796	2.1	2.6	180
	HXL0510-270uH/K	270 \pm 10%	0.796	30	0.796	2.5	2.4	170
	HXL0510-330uH/K	330 \pm 10%	0.796	30	0.796	3	2.2	160
	HXL0510-390uH/K	390 \pm 10%	0.796	30	0.796	3.5	2	150
	HXL0510-470uH/K	470 \pm 10%	0.796	30	0.796	4	1.9	140
	HXL0510-560uH/K	560 \pm 10%	0.796	30	0.796	5.4	1.8	130
	HXL0510-680uH/K	680 \pm 10%	0.796	40	0.796	6	1.5	120
	HXL0510-820uH/K	820 \pm 10%	0.796	50	0.796	7.5	1.2	110
	HXL0510-1.0mH/K	1000 \pm 10%	0.252	50	0.252	8	1	100
	HXL0510-1.2mH/K	1200 \pm 10%	0.252	60	0.252	14.5	0.95	95
	HXL0510-1.5mH/K	1500 \pm 10%	0.252	60	0.252	16.5	0.9	90
	HXL0510-1.8mH/K	1800 \pm 10%	0.252	60	0.252	19	0.9	85
	HXL0510-2.2mH/K	2200 \pm 10%	0.252	60	0.252	27.5	0.8	80
	HXL0510-2.7mH/K	2700 \pm 10%	0.252	60	0.252	40	0.75	75
	HXL0510-3.3mH/K	3300 \pm 10%	0.252	50	0.252	50	0.7	62
	HXL0510-3.9mH/K	3900 \pm 10%	0.252	50	0.252	53	0.65	59
	HXL0510-4.7mH/K	4700 \pm 10%	0.252	50	0.252	60	0.6	55
	HXL0510-5.6mH/K	5600 \pm 10%	0.252	50	0.252	64	0.5	40
	HXL0510-6.8mH/K	6800 \pm 10%	0.252	50	0.252	73	0.45	35
	HXL0510-8.2mH/K	8200 \pm 10%	0.252	30	0.252	80	0.4	30
	HXL0510-10mH/K	10000 \pm 10%	79.6k	25	79.6k	132	0.35	25
	HXL0510-12mH/K	12000 \pm 10%	79.6k	25	79.6k	143	0.3	20
	HXL0510-15mH/K	15000 \pm 10%	79.6k	25	79.6k	166	0.25	18
	HXL0510-18mH/K	18000 \pm 10%	79.6k	25	79.6k	185	0.2	15

厦门华信安电子科技有限公司 XIAMEN SINO FAITH ELECTRONIC TECHNOLOGY CO., LTD TEL: 0592-6301603 FAX: 0592-5205265  地址: 厦门市翔安区翔岳路25号东北栋	PREPARED	CHECKED	APPROVED
	王亮	龙梅	梁峰

SPECIFICATION FOR APPROVAL

**RoHS
COMPLIANT**

CUSTOMER		CUSTOMER P/N		PAGE
DESCRIPTION	AXIAL FIXED INDUCTOR	DRAWING No.	SP-HXA004-S04	6
CENKER P/N	HXL0510 Series	ISSUE DATE	2016-7-29	VERSION
				A0

8. ELECTRICAL REQUIREMENTS

Customer P/N	PART NO.	Inductance (uH)	Inductance Test Freq. [Hz]	Q (Min)	Q Test Freq. [MHz]	DCR [Ω] (Max)	SRF [MHz] (Min)	Rated Current [mA] (Max)
	HXL0510*22mH/K	22000 \pm 10%	1k	20	79.6k	330	0.15	12
	HXL0510*27mH/K	27000 \pm 10%	1k	20	79.6k	370	0.1	10
	HXL0510*30mH/K	30000 \pm 10%	1k	40	79.6k	240	0.25	10

***Rated Current: It is either the inductance is 10% lower than its initial value in DC saturation characteristics or temperature raise becomes $\Delta T=40^{\circ}C$ ($T_a=25^{\circ}C$), whichever is lower.**

厦门华信安电子科技有限公司 XIAMEN SINO FAITH ELECTRONIC TECHNOLOGY CO., LTD TEL: 0592-6301603 FAX: 0592-5205265  地址: 厦门市翔安区翔岳路25号东北栋	PREPARED	CHECKED	APPROVED
	王亮	龙梅	梁峰

SPECIFICATION FOR APPROVAL

**RoHS
COMPLIANT**

CUSTOMER		CUSTOMER P/N		PAGE
DESCRIPTION	AXIAL FIXED INDUCTOR	DRAWING No.	SP-HXA004-S04	7
CENKER P/N	HXL0510 Series	ISSUE DATE	2016-7-29	VERSION A0

9. TEST EQUIPMENT AND TEST CONDITION

- (1) Inductance: HP 4284A/HM 9481;
- (2) Q: HP 4284A/HM 9481;
- (3) DCR: CH 502A/CH 502BC/E34420A;
- (4) SRF: HM 9461;
- (5) Rated Current: HP 4284A+HP 42841A/CD 1068+CD 1320.
- (6) Test Condition: at 25°C,75%H.

10. WARNING FOR LEAD WIRE FORMING

This Inductor is using drum type core and wrapping wire at the both ends of the core. An inadequate lead wire forming process may cause open circuit and/or damage the body. Please comply with the following instruction when you bend the lead wire. When you execute a lead wire forming process by yourself.

Please apply supporting jigs as below:

(Minimum insertion pitch: 12.5mm Min)

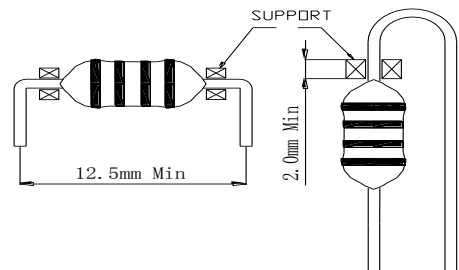

11. PACKING (UNIT: mm)

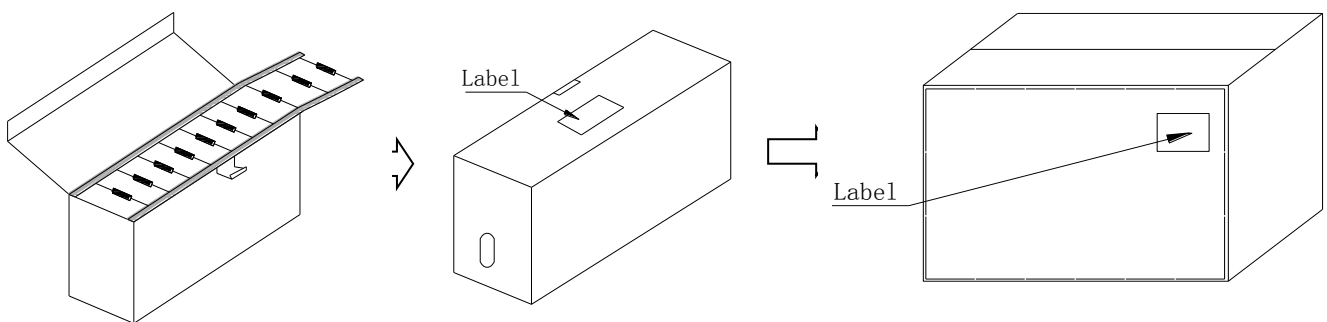

	Dimension	Quantity(Pcs)
Box	255*69*85	1,000
Carton	438*278*267	18,000

厦门华信安电子科技有限公司 XIAMEN SINO FAITH ELECTRONIC TECHNOLOGY CO.,LTD TEL: 0592-6301603 FAX: 0592-5205265 地址:厦门市翔安区翔岳路25号东北栋 	PREPARED	CHECKED	APPROVED
	王亮	龙梅	梁峰

SPECIFICATION FOR APPROVAL

**RoHS
COMPLIANT**

CUSTOMER		CUSTOMER P/N		PAGE
DESCRIPTION	AXIAL FIXED INDUCTOR	DRAWING No.	SP-HXA004-S04	8
CENKER P/N	HXL0510 Series	ISSUE DATE	2016-7-29	VERSION A0

12. RELIABILITY

* GENERAL CHARACTERISTICS

STANDARD TESTING CONDITIONS:

UNLESS OTHERWISE SPECIFIED, THE STANDARD RANGE OF ATMOSPHERIC CONDITIONS FOR MEASUREMENTS AND TESTS ARE AS FOLLOWS: AMBIENT TEMPERATURE: 15°C ~ 35°C. RELATIVE HUMIDITY: 25% ~ 85%. AIR PRESSURE: 86kPa ~ 106kPa.

No.	Items	Test Methods	Requirements
1	Lead terminal strength	A static pulling force of 5N in a direction parallel to the lead terminals for 60±5 seconds.	No terminal breakage or loosening.
2	Resistance to soldering heat test	Fix the samples on a 1.6mm thickness PCB, then dip the sample leads into a soldering bath of 260±5°C up to the PCB for 5±1 seconds.	No significant abnormality in appearance. Deviation relative to initial value: L: Within +10%
3	Solder ability test	Immerse the terminal in flux for 5 seconds. Then dip the terminal into a soldering bath of 245±5°C for 2±0.5 seconds.	At least 90% of terminal electrode is covered by new solder.
4	Humidity test	Temperature : 40°C ±2°C Humidity : 90% ~ 95% RH Duration : 96±4 Hours	No significant abnormality in appearance. Deviation relative to initial value: L: Within ±10%
5	High temperature storage test	Temperature : 85°C ±2°C Duration : 96±4 Hours	
6	Low temperature storage test	Temperature : -25°C ±2°C Time : 96±4 Hours	
7	Thermal shock test	First -25±5°C for 30±3 minutes, last 85±5°C 30±3 minutes as 1 cycles. Go through 10 cycles.	

厦门华信安电子科技有限公司 XIAMEN SINO FAITH ELECTRONIC TECHNOLOGY CO.,LTD  TEL: 0592-6301603 FAX: 0592-5205265 地址: 厦门市翔安区翔岳路25号东北栋		PREPARED 王亮	CHECKED 龙梅	APPROVED 梁峰
---	--	--------------------	-------------------	--------------------

单击下面可查看定价，库存，交付和生命周期等信息

[>>ISND\(华信安\)](#)