

*Parameters Subject to Change Without Notice*

## DESCRIPTION

The JW<sup>®</sup>5033S is a current mode monolithic buck voltage converter. Operating with an input range of 3.7V-18V, the JW5033S delivers 2A of continuous output current with two integrated N-Channel MOSFETs. At light loads, regulators operate in low frequency to maintain high efficiency and low output ripple.

The JW5033S guarantees robustness with short circuit protection, thermal protection, current run-away protection, and input under voltage lockout.

The JW5033S is available in a 6-pin TSOT23-6 and SOT563 package, which provides a compact solution with minimal external components.

Company's Logo is Protected, "JW" and "JOULWATT" are Registered Trademarks of JoulWatt technology Inc.

## FEATURES

- 3.7V to 18V operating input range
- 2A output current
- Up to 95% efficiency
- High efficiency at light load
- 800kHz Switching frequency
- Input under voltage lockout
- Start-up current run-away protection
- Over current protection and Hiccup
- Thermal protection
- Available in TSOT23-6 and SOT563 package

## APPLICATIONS

- Distributed Power Systems
- Networking Systems
- FPGA, DSP, ASIC Power Supplies
- Green Electronics/ Appliances
- Notebook Computers

## TYPICAL APPLICATION

### 3.3V/2A Step Down Regulator

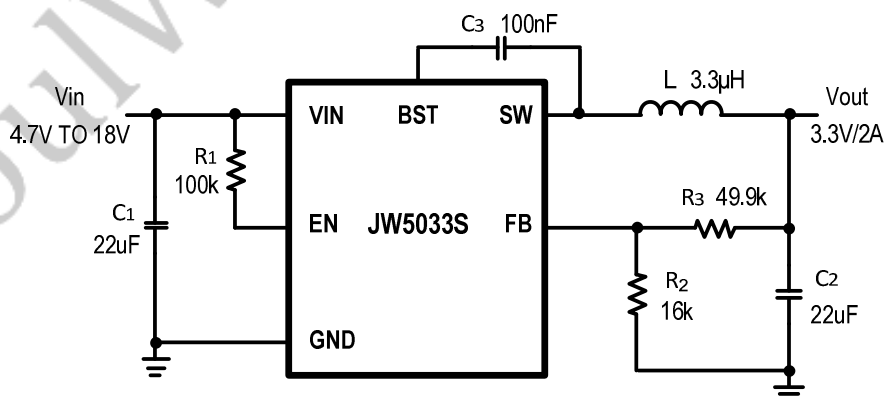

**ORDER INFORMATION**

DEVICE <sup>1)</sup>	PACKAGE	TOP MARKING <sup>2)</sup>
JW5033STSOTB#TRPBF	TSOT23-6	JWHSX YWLLL
JW5033SSOTI#TRPBF	SOT563	JWFX YWLL

**Notes :**

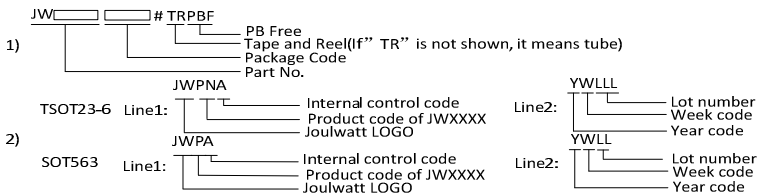

**PIN CONFIGURATION**

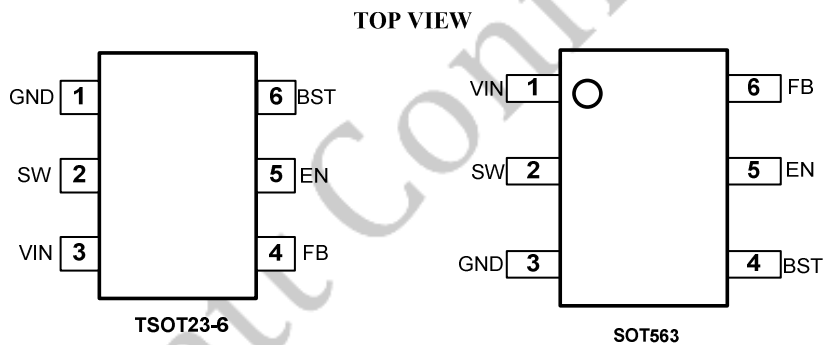

**ABSOLUTE MAXIMUM RATING<sup>1)</sup>**

VIN Pin .....	-0.3V to 20V
EN Pin .....	-0.3V to 20V
SW .....	-0.3V(-4.5V for 10ns) to 20V(22V for 10ns)
BST Pin .....	SW-0.3V to SW+5.5V
All other Pins .....	-0.3V to 6V
Junction Temp. <sup>2)3)</sup> .....	150°C
Lead Temperature .....	260°C
ESD Susceptibility (Human Body Model) .....	2kV

**RECOMMENDED OPERATING CONDITIONS**

Input Voltage VIN .....	3.7V to 18V
Output Voltage Vout .....	0.8V to VIN-3V

**THERMAL PERFORMANCE<sup>4)</sup>**

Package	Absolute Max Storage Temp.	Recommended Operating Junction Temp. Range	Recommended Max Case Temp. $T_c$ (°C)	Abs. Max Junction Temp. $T_j$ (°C)	Recommended Max Power Loss $P_D@25^\circ\text{C}$ (W)
TSOT23-6 SOT563	-65°C to 150°C	-40°C to 125°C	119	150	0.9
Package	$R_{\theta JC}$ (°C/W)	$R_{\theta JA}$ (°C/W)	$R_{\theta JB}$ (°C/W)	$\Psi_{JT}$ (°C/W)	$\Psi_{JB}$ (°C/W)
TSOT23-6	55	110	14.7	1.2	14.7
SOT563	60	130	17.6	1.5	17.4

**Note:**

- 1) Exceeding these ratings may damage the device.
- 2) The JW5033S guarantees robust performance from -40°C to 150°C junction temperature. The junction temperature range specification is assured by design, characterization and correlation with statistical process controls.
- 3) The JW5033S includes thermal protection that is intended to protect the device in overload conditions. Thermal protection is active when junction temperature exceeds the maximum operating junction temperature. Continuous operation over the specified absolute maximum operating junction temperature may damage the device.
- 4) Measured on JESD51-7, 4-layer PCB

## ELECTRICAL CHARACTERISTICS

<i>V<sub>IN</sub>=12V, T<sub>A</sub>=25 °C, Unless otherwise stated.</i>						
Item	Symbol	Conditions	Min.	Typ.	Max.	Unit
V <sub>IN</sub> Under Voltage Lock-out Threshold	V <sub>IN_MIN</sub>	V <sub>IN</sub> rising	3.2	3.4	3.7	V
V <sub>IN</sub> Under voltage Lockout Hysteresis <sup>5)</sup>	V <sub>IN_MIN_HYST</sub>			300		mV
Shutdown Supply Current	I <sub>SD</sub>	V <sub>EN</sub> =0V		0.1	1	μA
Supply Current	I <sub>Q</sub>	V <sub>EN</sub> =5V, V <sub>FB</sub> =1.2V		120	150	μA
Feedback Voltage	V <sub>FB</sub>	3.7V<V <sub>IN</sub> <18V	776	800	824	mV
Top Switch Resistance <sup>5)</sup>	R <sub>DS(ON)T</sub>			130		mΩ
Bottom Switch Resistance <sup>5)</sup>	R <sub>DS(ON)B</sub>			70		mΩ
Top Switch Leakage Current	I <sub>LEAK_TOP</sub>	V <sub>IN</sub> =18V, V <sub>EN</sub> =0V, V <sub>SW</sub> =0V		0.1	1	μA
Bottom Switch Leakage Current	I <sub>LEAK_BOT</sub>	V <sub>IN</sub> =18V, V <sub>EN</sub> =0V, V <sub>SW</sub> =18V		0.1	1	μA
Top Switch Current Limit <sup>5)</sup>	I <sub>LIM_TOP</sub>	Minimum Duty Cycle	3.2	3.9		A
Switch Frequency	F <sub>SW</sub>		600	800	1000	kHz
Minimum On Time <sup>5)</sup>	T <sub>ON_MIN</sub>			100		ns
Minimum Off Time <sup>5)</sup>	T <sub>OFF_MIN</sub>	V <sub>FB</sub> =0.4V		150		ns
EN Input High Voltage	V <sub>EN_H</sub>		2.4			V
EN Input Low Voltage	V <sub>EN_L</sub>				1.8	V
Thermal Shutdown <sup>5)</sup>	T <sub>TSD</sub>			145		°C
Thermal Shutdown hysteresis <sup>5)</sup>	T <sub>TSD_HYST</sub>			20		°C

**Note:**

5) Guaranteed by design.

**PIN DESCRIPTION**

TSOT23-6 Pin	SOT563 Pin	Name	Description
1	3	GND	Ground.
2	2	SW	SW is the switching node that supplies power to the output. Connect the output LC filter from SW to the output load.
3	1	VIN	Input voltage pin. VIN supplies power to the IC. Connect a 3.7V to 18V supply to VIN and bypass VIN to GND with a suitably large capacitor to eliminate noise on the input to the IC.
4	6	FB	Output feedback pin. FB senses the output voltage and is regulated by the control loop to 0.8V. Connect a resistive divider at FB.
5	5	EN	Drive EN pin high to turn on the regulator and low to turn off the regulator.
6	4	BST	Bootstrap pin for top switch. A 0.1uF or larger capacitor should be connected between this pin and the SW pin to supply current to the top switch and top switch driver.

**BLOCK DIAGRAM**

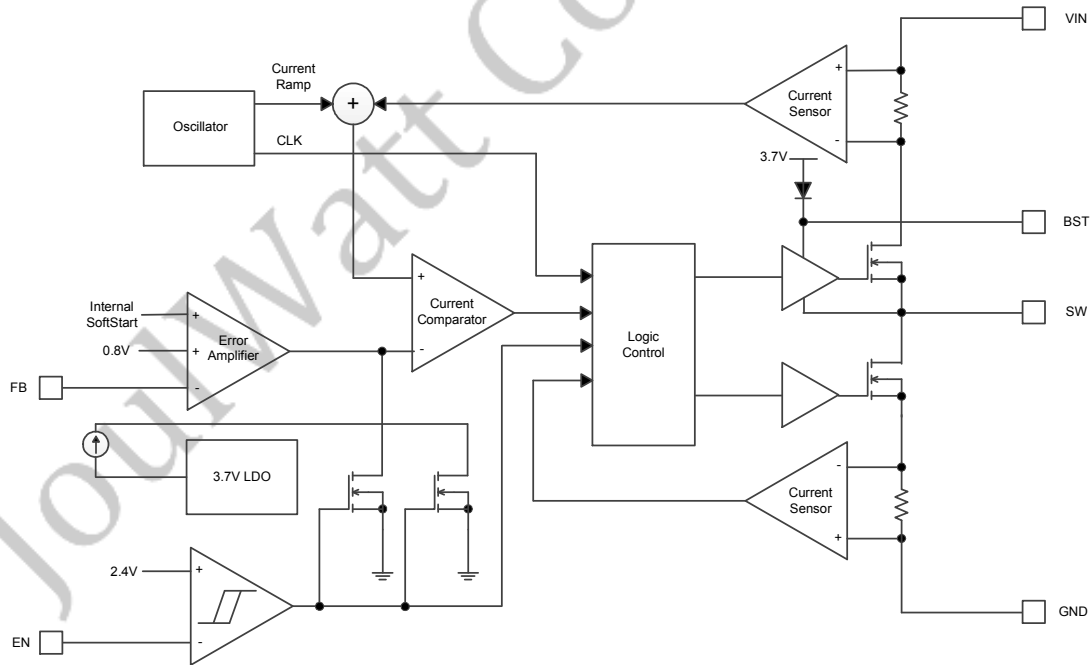

TYPICAL PERFORMANCE CHARACTERISTICS

Vin =12V, Vout = 3.3V, L = 3.3μH, Cout = 22μF, TA = +25°C, unless otherwise noted

**Steady State Test**

VIN=12V, Vout=3.3V  
Iout=2A

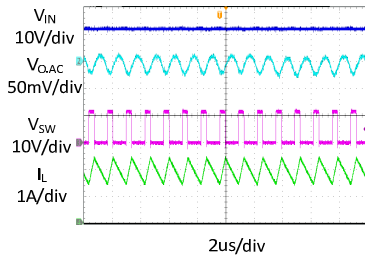

**Startup through Enable**

VIN=12V, Vout=3.3V  
Iout=2A(Resistive load)

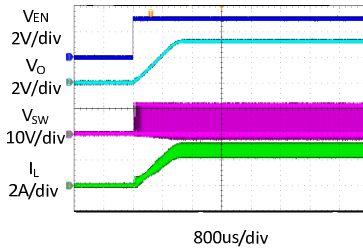

**Shutdown through Enable**

VIN=12V, Vout=3.3V  
Iout=2A (Resistive load)

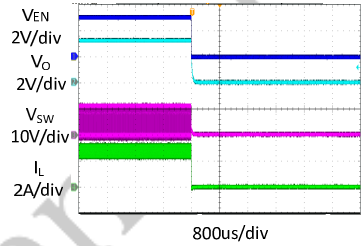

**Heavy Load Operation**

2A LOAD

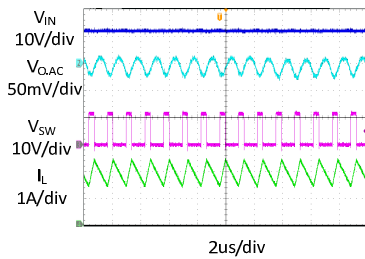

**Medium Load Operation**

1A LOAD

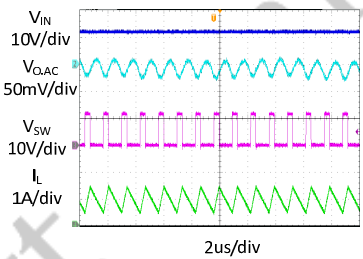

**Light Load Operation**

0 A LOAD

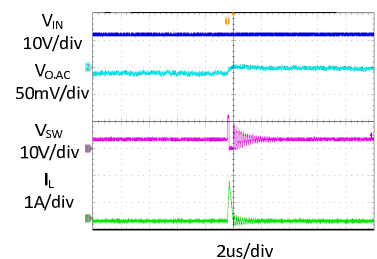

**Short Circuit Protection**

VIN=12V, Vout=3.3V  
Iout=2A- Short

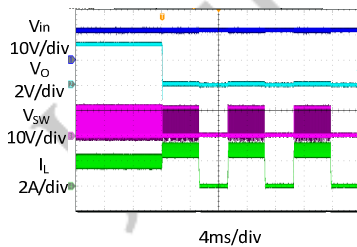

**Short Circuit Recovery**

VIN=12V, Vout=3.3V  
Iout= Short-2A

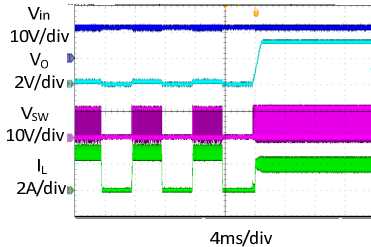

**Load Transient**

1A LOAD → 2A LOAD → 1A LOAD  
Current Slew rate: 2.5A/us

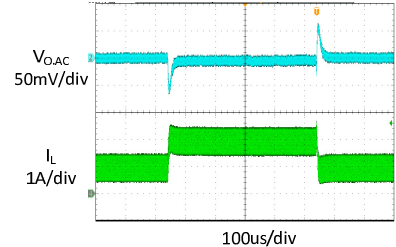

TYPICAL PERFORMANCE CHARACTERISTICS (continued)

Vin=12V, TA = +25°C, unless otherwise noted

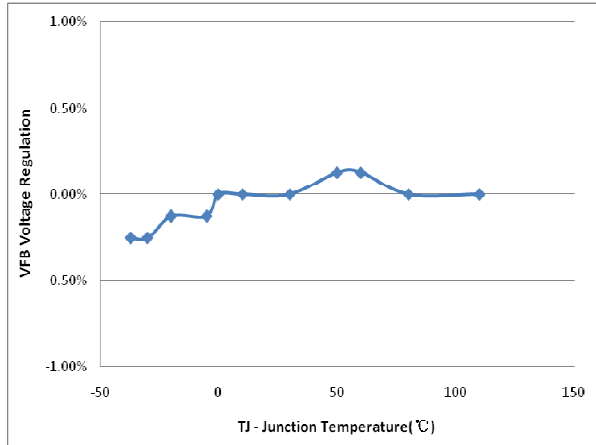

Figure 1. VFB Voltage Regulation vs Junction Temperature

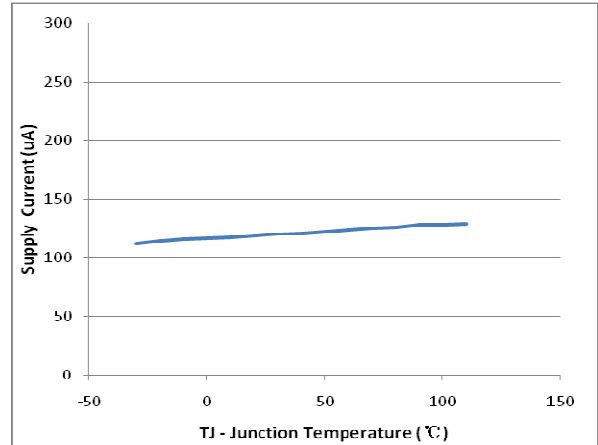

Figure 2. Supply Current vs Junction Temperature

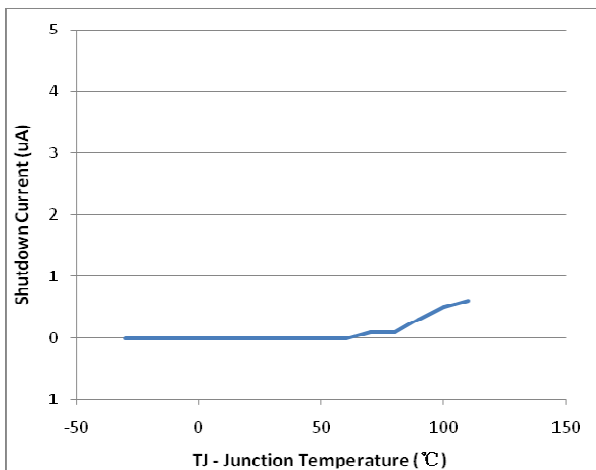

Figure 3. Shutdown Current vs Junction Temperature

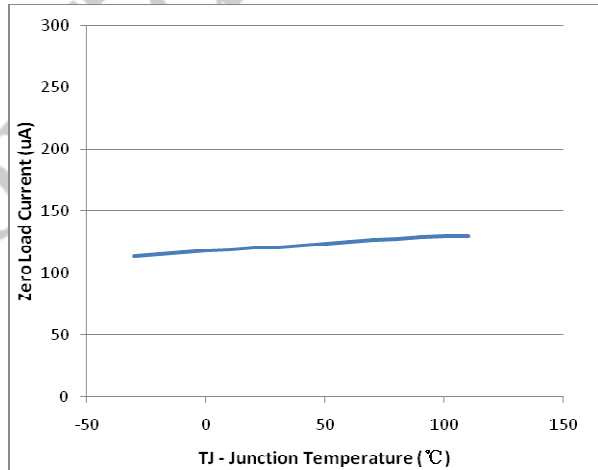

Figure 4. Zero-Load Current vs Junction Temperature

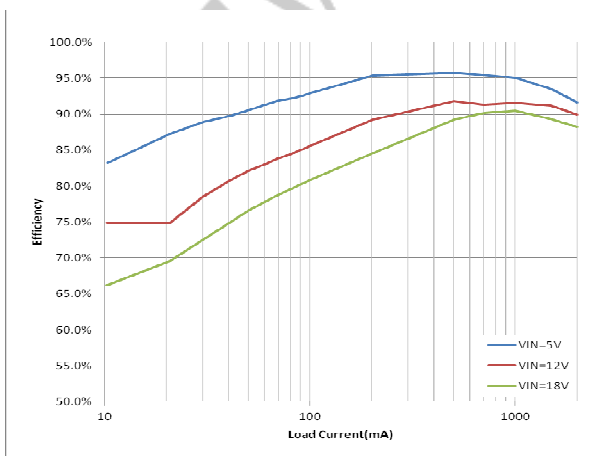

Figure 5. Efficiency vs Load Current  
(Vout=3.3V, TSOT23-6)

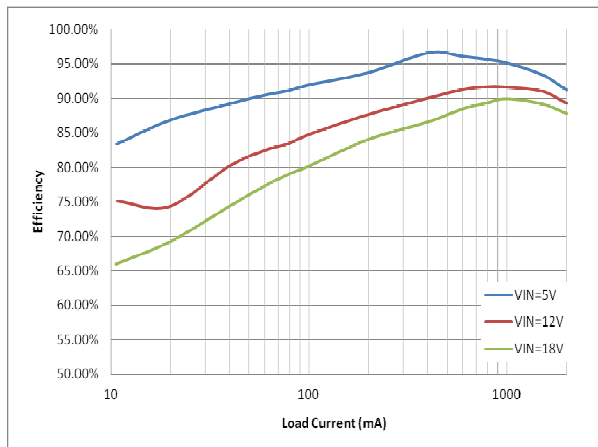

Figure 6. Efficiency vs Load Current  
(Vout=3.3V, SOT563)

TYPICAL PERFORMANCE CHARACTERISTICS (continued)

Vin=12V, TA = +25°C, unless otherwise noted

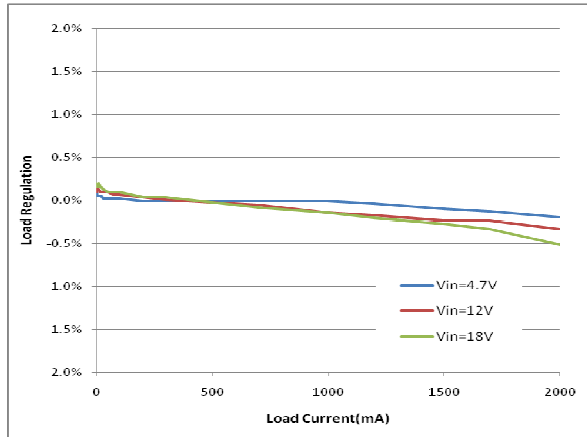

Figure 7. Output Voltage Regulation vs Load Current (Vout=3.3V, L=3.3uH)

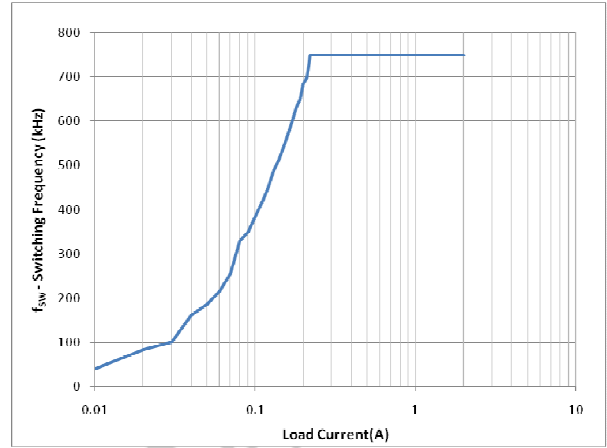

Figure 8. Switching Frequency vs Load Current (Vout=1V)

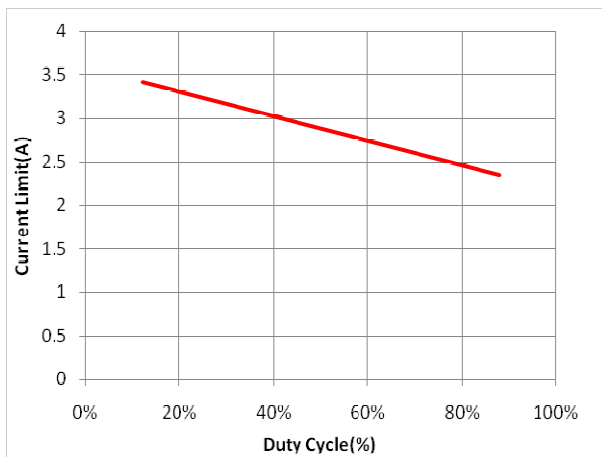

Figure 9. Duty Cycle vs Current Limit



## FUNCTIONAL DESCRIPTION

The JW5033S is a synchronous, current-mode, step-down regulator. It regulates input voltages from 3.7V to 18V down to an output voltage as low as 0.8V, and is capable of supplying up to 2A of load current.

### Current-Mode Control

The JW5033S utilizes current-mode control to regulate the FB voltage. Voltage at the FB pin is regulated at 0.8V so that by connecting an appropriate resistive divider between VOUT and GND, designed output voltage can be achieved.

### PFM Mode

The JW5033S operates in PFM mode at light load. In PFM mode, switch frequency decreases when load current drops to boost power efficiency at light load by reducing switch-loss, while switch frequency increases when load current rises, minimizing output voltage ripples.

### Internal Soft-Start.

Soft-Start makes output voltage rising smoothly follow an internal SS voltage until SS voltage is higher than the internal reference voltage. It can prevent overshoot of output voltage when startup.

### Power Switch

N-Channel MOSFET switches are integrated on the JW5033S to down convert the input voltage to the regulated output voltage. Since the top MOSFET needs a gate voltage greater than the input voltage, a boost capacitor connected between BST and SW pins is required to drive the gate of the top switch. The boost capacitor is charged by the internal 3.7V rail when SW is

low.

### Vin Under-Voltage Protection

A resistive divider can be connected between Vin and GND, with the central tap connected to EN, so that when Vin drops to the pre-set value, EN drops below 1.8V to trigger input under voltage lockout protection.

### Output Current Run-Away Protection

At start-up, due to the high voltage at input and low voltage at output, current inertia of the output inductance can be easily built up, resulting in a large start-up output current. A valley current limit is designed in the JW5033S so that only when output current drops below the valley current limit can the top power switch be turned on. By such control mechanism, the output current at start-up is well controlled.

### Over Current Protection and Hiccup

JW5033S has a cycle-by-cycle current limit. When the inductor current triggers current limit, JW5033S enters hiccup mode and periodically restart the chip.

JW5033S will exit hiccup mode while not triggering current limit.

### Thermal Protection

When the temperature of the JW5033S rises above 145°C, it is forced into thermal shut-down.

Only when core temperature drops below 125°C can the regulator becomes active again.

## APPLICATION INFORMATION

### Output Voltage Set

The output voltage is determined by the resistor divider connected at the FB pin, and the voltage ratio is:

$$V_{FB} = V_{OUT} \cdot \frac{R_2}{R_2 + R_3}$$

where  $V_{FB}$  is the feedback voltage and  $V_{OUT}$  is the output voltage.

In order to reduce the interference of noise on FB.  $R_2$  must be selected less than 30kΩ. Choose  $R_2$  around 15kΩ, and then  $R_3$  can be calculated by:

$$R_3 = R_2 \cdot \left( \frac{V_{OUT}}{0.8V} - 1 \right)$$

The following table lists the recommended values.

V <sub>OUT</sub> (V)	R <sub>2</sub> (kΩ)	R <sub>3</sub> (kΩ)
2.5	22.1	47
3.3	16	49.9
5	20	105

### Input Capacitor

The input capacitor is used to supply the AC input current to the step-down converter and maintaining the DC input voltage. The ripple current through the input capacitor can be calculated by:

$$I_{C1} = I_{LOAD} \cdot \sqrt{\frac{V_{OUT}}{V_{IN}} \cdot \left( 1 - \frac{V_{OUT}}{V_{IN}} \right)}$$

where  $I_{LOAD}$  is the load current,  $V_{OUT}$  is the output voltage,  $V_{IN}$  is the input voltage.

Thus the input capacitor can be calculated by the following equation when the input ripple voltage is determined.

$$C_1 = \frac{I_{LOAD}}{f_s \cdot \Delta V_{IN}} \cdot \frac{V_{OUT}}{V_{IN}} \cdot \left( 1 - \frac{V_{OUT}}{V_{IN}} \right)$$

where  $C_1$  is the input capacitance value,  $f_s$  is the switching frequency,  $\Delta V_{IN}$  is the input ripple voltage.

The input capacitor can be electrolytic, tantalum or ceramic. To minimizing the potential noise, a small X5R or X7R ceramic capacitor, i.e. 0.1uF, should be placed as close to the IC as possible when using electrolytic capacitors.

A 22uF ceramic capacitor is recommended in typical application.

### Output Capacitor

The output capacitor is required to maintain the DC output voltage, and the capacitance value determines the output ripple voltage. The output voltage ripple can be calculated by:

$$\Delta V_{OUT} = \frac{V_{OUT}}{f_s \cdot L} \cdot \left( 1 - \frac{V_{OUT}}{V_{IN}} \right) \cdot \left( R_{ESR} + \frac{1}{8 \cdot f_s \cdot C_2} \right)$$

where  $C_2$  is the output capacitance value and  $R_{ESR}$  is the equivalent series resistance value of the output capacitor.

The output capacitor can be low ESR electrolytic, tantalum or ceramic, which lower ESR capacitors get lower output ripple voltage.

The output capacitors also affect the system stability and transient response, and a 22uF ceramic capacitor is recommended in typical application.

### Inductor

The inductor is used to supply constant current to the output load, and the value determines the ripple current which affect the efficiency and the

output voltage ripple. The ripple current is typically allowed to be 40% of the maximum switch current limit, thus the inductance value can be calculated by:

$$L = \frac{V_{OUT}}{f_s \cdot \Delta I_L} \cdot \left(1 - \frac{V_{OUT}}{V_{IN}}\right)$$

where  $V_{IN}$  is the input voltage,  $V_{OUT}$  is the output voltage,  $f_s$  is the switching frequency, and  $\Delta I_L$  is the peak-to-peak inductor ripple current.

**External Bootstrap Capacitor**

A bootstrap capacitor is required to supply voltage to the top switch driver. A 0.1uF low ESR ceramic capacitor is recommended to be connected to the BST pin and SW pin.

**PCB Layout Note**

For minimum noise problem and best operating performance, the PCB is preferred to following the guidelines as reference.

1. Place the input decoupling capacitor as close to JW5033S (VIN pin and PGND) as possible to eliminate noise at the input pin. The loop area formed by input capacitor and GND must be minimized.
2. Put the feedback trace as far away from the inductor and noisy power traces as possible.
3. The ground plane on the PCB should be as large as possible for better heat dissipation.

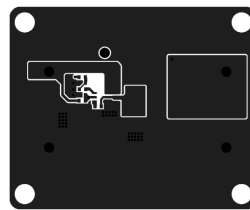

Figure 1. Top Layer

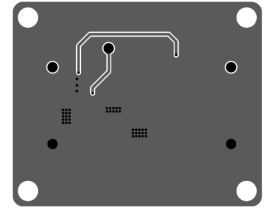

Figure 2. Bottom Layer

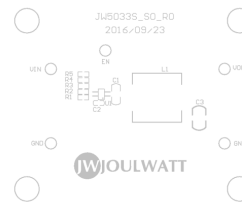

Figure 3. Silk Layer

REFERENCE DESIGN

Reference 1:

$V_{IN}$  : 4.7V ~ 18V

$V_{OUT}$ : 3.3V

$I_{OUT}$  : 0~2A

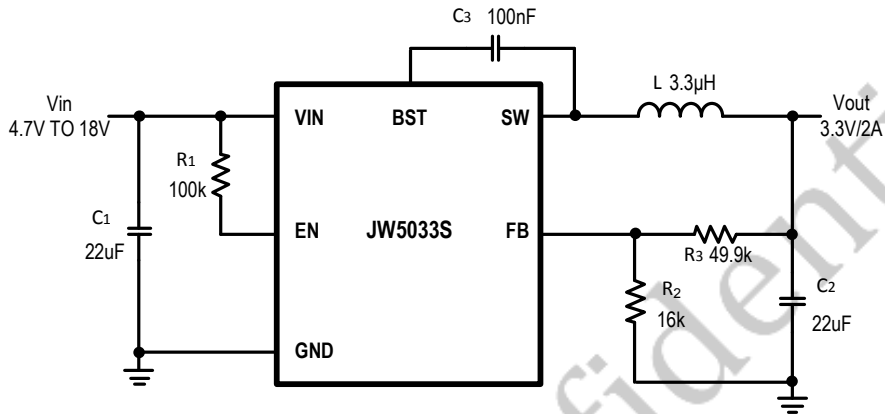

Reference 2:

$V_{IN}$  : 6V ~ 18V

$V_{OUT}$ : 5V

$I_{OUT}$  : 0~2A

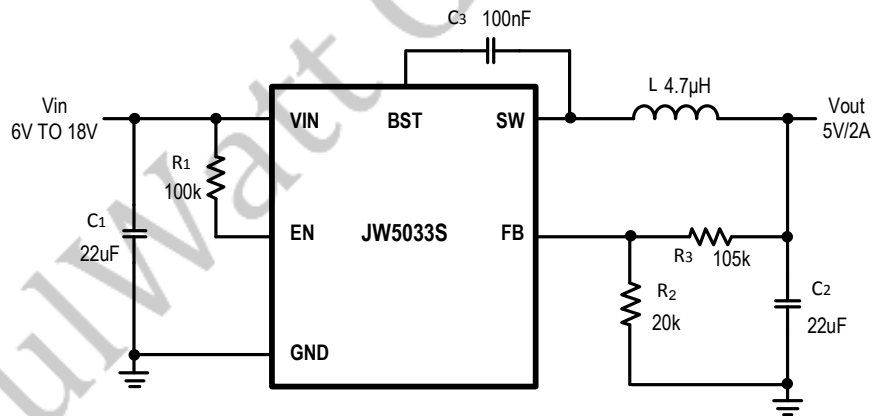

PACKAGE OUTLINE

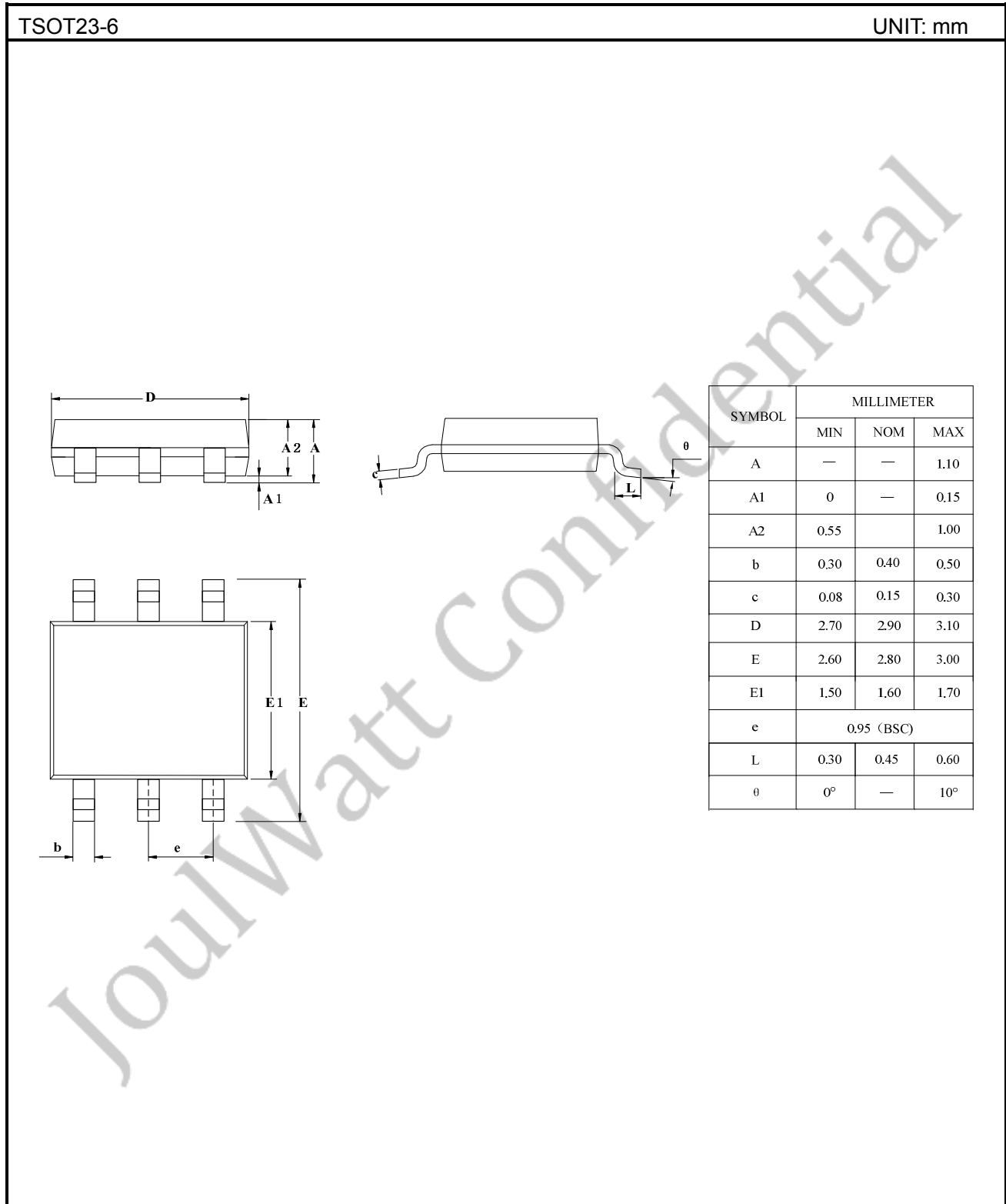

SOT563

UNIT: mm

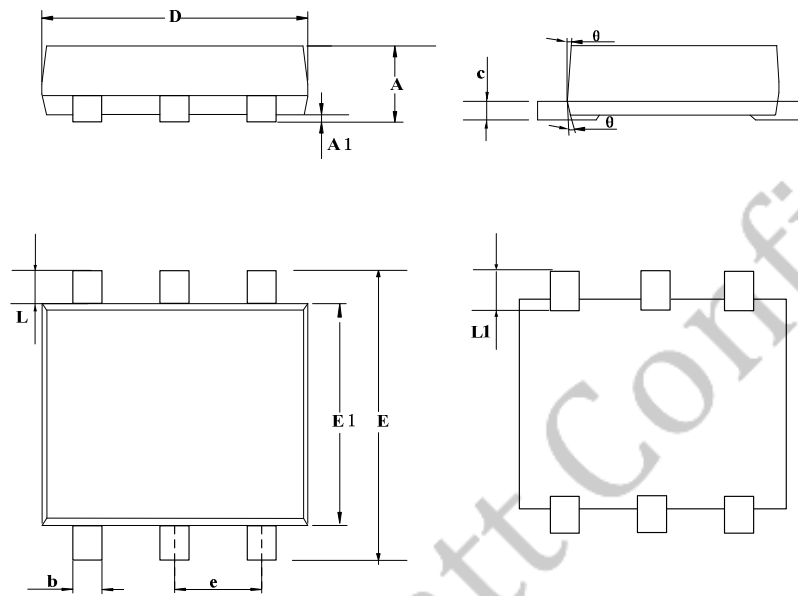

SYMBOL	MILLIMETER		
	MIN	NOM	MAX
A	0.525	—	0.60
A1	0.00	—	0.05
b	0.17	0.22	0.27
c	0.09	—	0.16
D	1.50	1.60	1.70
E	1.50	1.60	1.70
E1	1.10	1.20	1.30
e	0.45	0.50	0.55
L	0.10	0.20	0.30
L1	0.20	0.30	0.4
$\theta$	7°REF		

**IMPORTANT NOTICE**

- Joulwatt Technology Inc. reserves the right to make modifications, enhancements, improvements, corrections or other changes without further notice to this document and any product described herein.
- Any unauthorized redistribution or copy of this document for any purpose is strictly forbidden.
- Joulwatt Technology Inc. does not warrant or accept any liability whatsoever in respect of any products purchased through unauthorized sales channel.

JoulWatt Confidential

*Copyright © 2017 JW5033S Incorporated.*

*All rights are reserved by Joulwatt Technology Inc.*

单击下面可查看定价，库存，交付和生命周期等信息

[>>JOULWATT\(杰华特\)](#)