

DATA SHEET

NEC/TOKIN

RoHS Compliant

MINIATURE SIGNAL RELAY

EC2/EE2 SERIES

COMPACT SIZE, SLIM-PACKAGE

DESCRIPTION

NEC TOKIN EC2/EE2 relay is a standard miniature signal relay, compact and slim.

FEATURES

- Compact and light weight
- FCC (1500 V) and Telcordia (2500 V) surge capacity
- UL recognized and CSA certified.
- Low power consumption (100-200 mW)
- ND type (High insulation) conform to supplement insulation for EN60950
- NKX type (High breakdown voltage) can withstand 1.5KVAC at open contacts

APPLICATIONS

Electronic switching systems, PBX, Terminal equipment, Telephone system

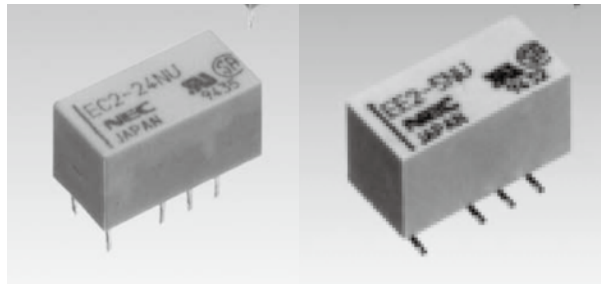

For Right Use of Miniature Relays

DO NOT EXCEED MAXIMUM RATINGS.

Do not use relays under exceeding conditions such as over ambient temperature, over voltage and over current. Incorrect use could result in abnormal heating, damage to related parts or cause burning.

READ CAUTIONS IN THE SELECTION GUIDE.

Read the cautions described in NEC TOKIN's "Miniature Relays" when you choose relays for your application.

The information in this document is subject to change without notice.

© NEC TOKIN Corporation 2012



- All specifications in this catalog and production status of products are subject to change without notice. Prior to the purchase, please contact NEC TOKIN for updated product data.
- Please request for a specification sheet for detailed product data prior to the purchase.
- Before using the product in this catalog, please read "Precautions" and other safety precautions listed in the printed version catalog.

2012.09.12 9600SD2VOL02E1209H0

DIMENSIONS AND PAD LAYOUTS Unit: mm (inch)

EC2 SERIES

Non-latch type, Single coil latch type

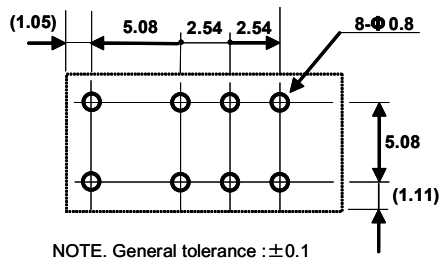
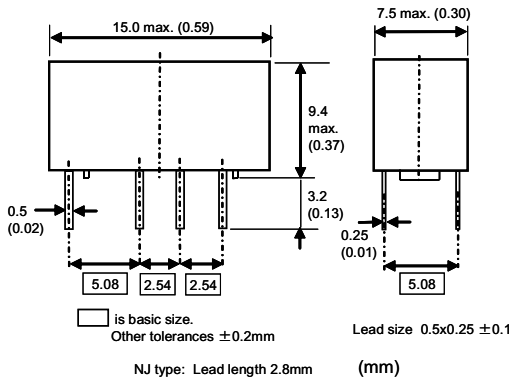

(Bottom view)

Double coil latch type

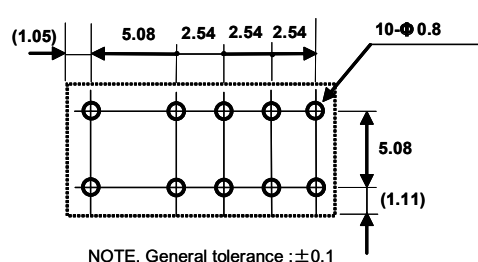
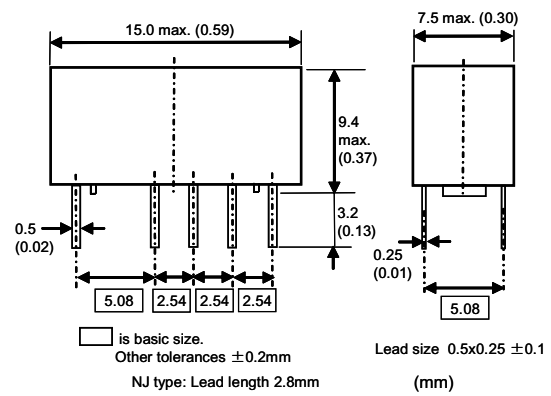

(Bottom view)

EE2 SERIES

Standard/ Non-latch type, Single coil latch type

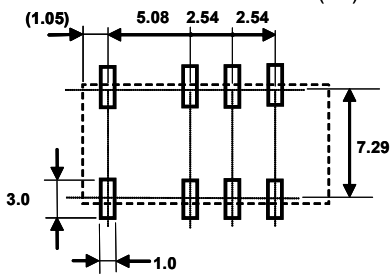
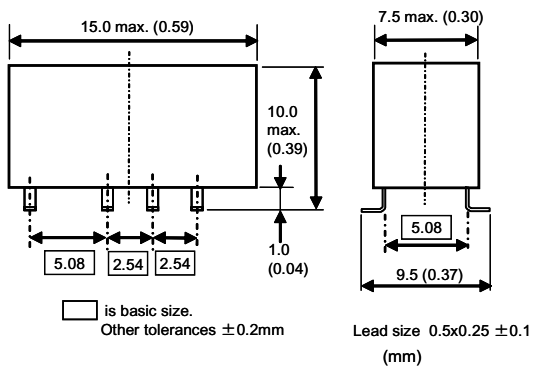

(Top view)

Standard/ Double coil latch type

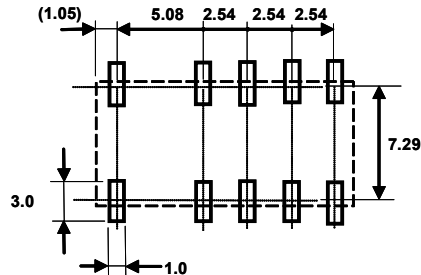
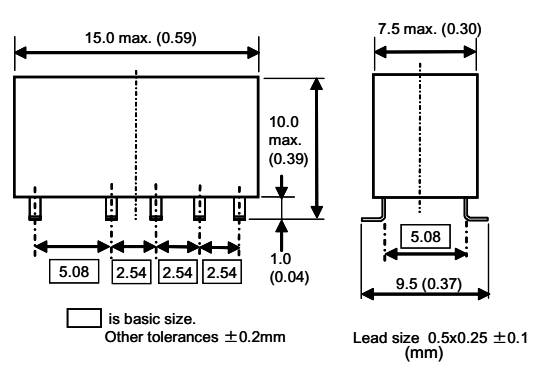

(Top view)



● All specifications in this catalog and production status of products are subject to change without notice. Prior to the purchase, please contact NEC TOKIN for updated product data.
● Please request for a specification sheet for detailed product data prior to the purchase.
● Before using the product in this catalog, please read "Precautions" and other safety precautions listed in the printed version catalog.

Minimum footprint / Non-latch type, Single coil latch type

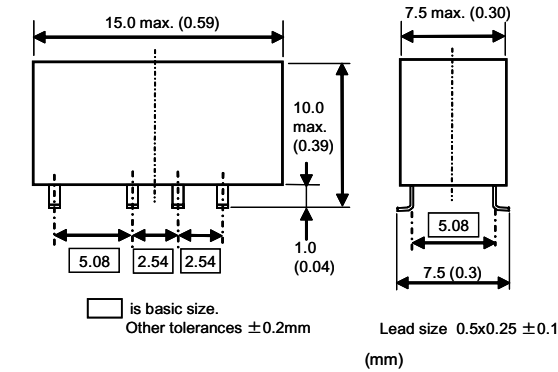

Minimum footprint/ Double coil latch type

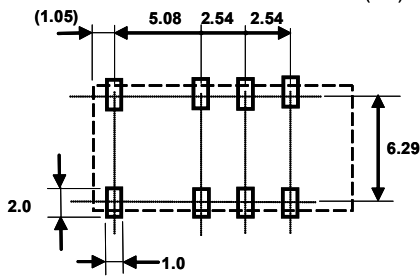
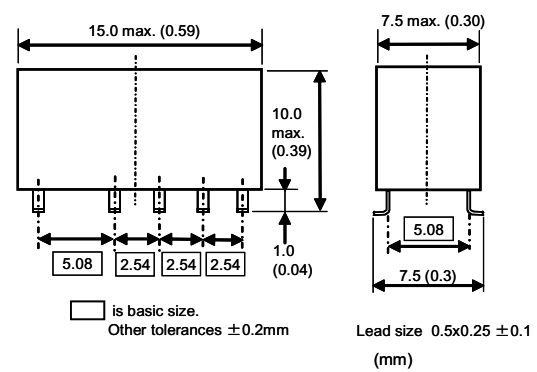

NOTE. General tolerance : ± 0.1
(Top view)

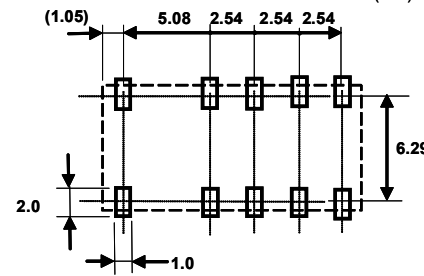

NOTE. General tolerance : ± 0.1
(Top view)

High solder joint reliability/
Non-latch type, Single coil latch type

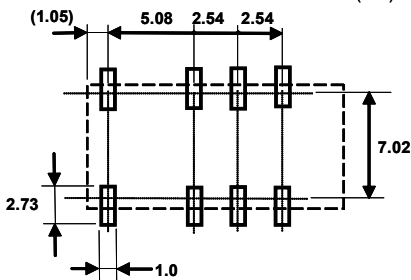
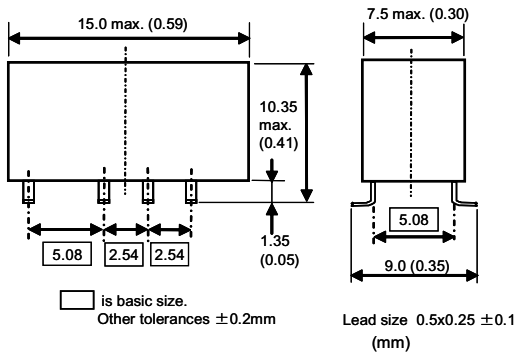

NOTE. General tolerance : ± 0.1
(Top view)

High solder joint reliability /
Double coil latch type

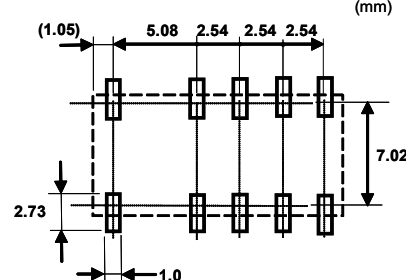
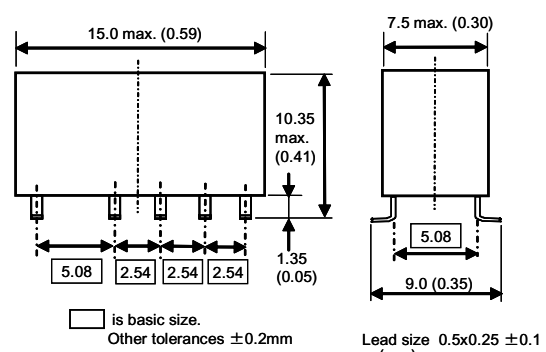

NOTE. General tolerance : ± 0.1
(Top view)



- All specifications in this catalog and production status of products are subject to change without notice. Prior to the purchase, please contact NEC TOKIN for updated product data.
- Please request for a specification sheet for detailed product data prior to the purchase.
- Before using the product in this catalog, please read "Precautions" and other safety precautions listed in the printed version catalog.

PIN CONFIGURATIONS (Bottom view)

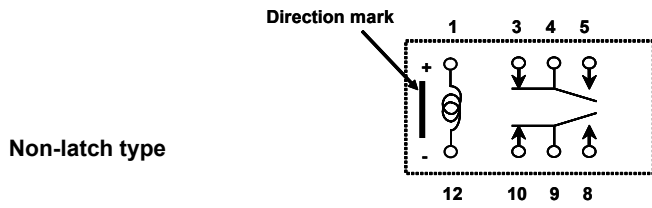

Non-latch type
(Not energized position)

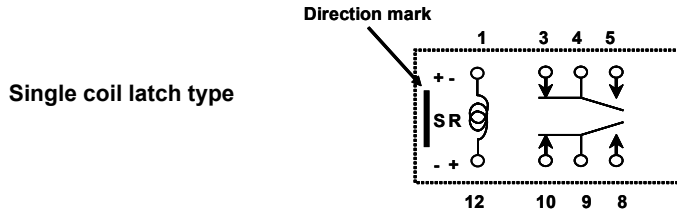

S: Coil polarity for Set
R: Coil polarity for Reset
Single coil latch type
(Reset position)

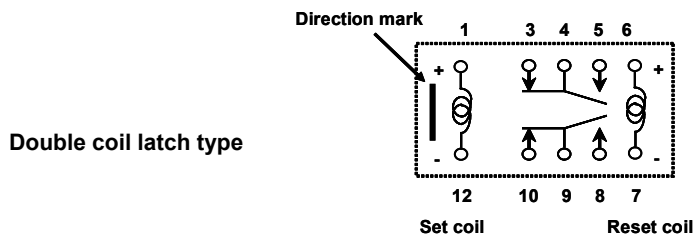

Double coil latch type
(Reset position)

MARKINGS (top view)

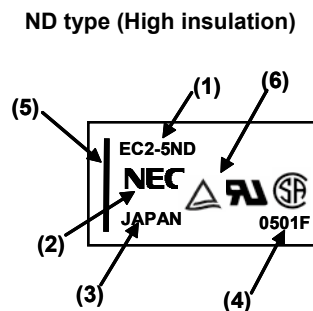
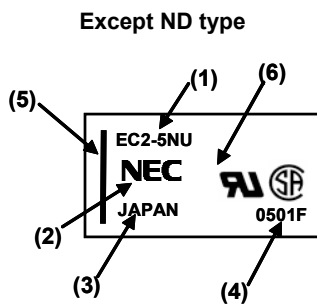

- (1) Part number
- (2) Manufacturer
- (3) Country of origin
- (4) Date code
- (5) Direction mark (pin No. 1 and 12)
- (6) UL,CSA marking (TUV added for ND type)



● All specifications in this catalog and production status of products are subject to change without notice. Prior to the purchase, please contact NEC TOKIN for updated product data.
● Please request for a specification sheet for detailed product data prior to the purchase.
● Before using the product in this catalog, please read "Precautions" and other safety precautions listed in the printed version catalog.

GENERAL SPECIFICATIONS

Contact Form		2 Form C
Contact Material		Silver alloy with gold alloy overlay
Contact Ratings	Maximum Switching Power	60 W, 125 VA
	Maximum Switching Voltage	220 VDC, 250 VAC
	Maximum Switching Current	2 A
	Maximum Carrying Current	2 A
Minimum Contact Ratings		10 m VDC, 10 μ A *1
Initial Contact Resistance		75 m Ω max. (initial)
Operate Time (Excluding bounce)		Approx. 2 ms
Release Time (Excluding bounce)		Approx. 1 ms
Insulation Resistance		1000 M Ω at 500 VDC
Withstanding Voltage	Between open contacts	1000 VAC (for one minute) 1500 V surge (10x160 μ s *2) [High breakdown voltage (NKX) type] Make contact: 1500 VAC (for one minute) 2500 V surge (2x10 μ s *3) Break contact: 1000 VAC (for one minute) 1500 V surge (10x160 μ s *2)
		1000 VAC (for one minute) 1500 V surge (10x160 μ s *2)
	Between coil and contacts	1500 VAC (for one minute) , 2500 V surge (2x10 μ s *3) [Double coil latch type] 1000 VAC (for one minute) 1500 V surge (10x160 μ s *2)
Shock Resistance		735 m/s ² (75G) (misoperation) 980 m/s ² (100G) (destructive failure)
Vibration Resistance		10 to 55 Hz, double amplitude 3 mm(20G) (misoperation) 10 to 55 Hz, double amplitude 5 mm(30G) (destructive failure)
Ambient Temperature		- 40 to + 85 $^{\circ}$ C
Coil Temperature Rise		18 $^{\circ}$ C at nominal coil voltage (140mW)
Running Specifications	Nonload	1x10 ⁸ operations (Non-latch type) *4 1x10 ⁷ operations (latch type)
	Load	50 VDC 0.1A (resistive), 1x10 ⁶ operations at 85 $^{\circ}$ C ,5Hz 10 VDC 10mA (resistive), 1x10 ⁶ operations at 85 $^{\circ}$ C ,2Hz
Weight		Approx. 1.9 g

*1 This value is a reference value in the resistance load.

Minimum capacity changes depending on switching frequency and environment temperature and the load.

*2 rise time: 10 μ s, decay time to half crest: 160 μ s

*3 rise time: 2 μ s, decay time to half crest: 10 μ s

*4 This shows the number of operations with fatal defects. Stable characteristics are maintained for 1 \times 10⁷ operations.



- All specifications in this catalog and production status of products are subject to change without notice. Prior to the purchase, please contact NEC TOKIN for updated product data.
- Please request for a specification sheet for detailed product data prior to the purchase.
- Before using the product in this catalog, please read "Precautions" and other safety precautions listed in the printed version catalog.

COIL SPECIFICATIONS

Non-latch Type

at 20°C

Nominal Coil Voltage (VDC)	Coil Resistance (Ω) ± 10%	Must Operate Voltage* (VDC)	Must Release Voltage* (VDC)	Nominal Operating Power (mW)
3	64.3	2.25	0.3	140
4.5	145	3.38	0.45	140
5	178	3.75	0.5	140
9	579	6.75	0.9	140
12	1028	9.0	1.2	140
24	2880	18.0	2.4	200

Single Coil Latch Type

at 20°C

Nominal Coil Voltage (VDC)	Coil Resistance (Ω) ± 10%	Set Voltage* (VDC)	Reset Voltage* (VDC)	Nominal Operating Power (mW)
3	90	2.25	2.25	100
4.5	202.5	3.38	3.38	100
5	250	3.75	3.75	100
9	810	6.75	6.75	100
12	1440	9.0	9.0	100
24	5760	18.0	18.0	100

Double Coil Latch Type (Can not be driven by reverse polarity for reverse operation)

at 20°C

Nominal Coil Voltage (VDC)	Coil Resistance (Ω) ± 10%		Set Voltage** (VDC)	Reset Voltage** (VDC)	Nominal Operating Power (mW)
	S	R			
3	S	64.3	2.25	-	140
	R	64.3	-	2.25	
4.5	S	145	3.38	-	140
	R	145	-	3.38	
5	S	178	3.75	-	140
	R	178	-	3.75	
9	S	579	6.75	-	140
	R	579	-	6.75	
12	S	1028	9.0	-	140
	R	1028	-	9.0	
24	S	4114	18.0	-	140
	R	4114	-	18.0	

Non-latch High Insulation (ND) Type

at 20°C

Nominal Coil Voltage (VDC)	Coil Resistance (Ω) ± 10%	Must Operate Voltage* (VDC)	Must Release Voltage* (VDC)	Nominal Operating Power (mW)
3	45	2.25	0.3	200
4.5	101	3.38	0.45	200
5	125	3.75	0.5	200
9	405	6.75	0.9	200
12	720	9.0	1.2	200
24	2504	18.0	2.4	230



● All specifications in this catalog and production status of products are subject to change without notice. Prior to the purchase, please contact NEC TOKIN for updated product data.
 ● Please request for a specification sheet for detailed product data prior to the purchase.
 ● Before using the product in this catalog, please read "Precautions" and other safety precautions listed in the printed version catalog.

Single Coil Latch High Insulation (ND) Type

at 20°C

Nominal Coil Voltage (VDC)	Coil Resistance (Ω) \pm 10%	Set Voltage* (VDC)	Reset Voltage* (VDC)	Nominal Operating Power (mW)
3	90	2.25	2.25	100
4.5	203	3.38	3.38	100
5	250	3.75	3.75	100
9	810	6.75	6.75	100
12	960	9.0	9.0	150
24	3388	18.0	18.0	170

Non-latch High Breakdown Voltage (NKX) Type

at 20°C

Nominal Coil Voltage (VDC)	Coil Resistance (Ω) \pm 10%	Must Operate Voltage* (VDC)	Must Release Voltage* (VDC)	Nominal Operating Power (mW)
3	39.1	2.25	0.3	230
4.5	88.0	3.38	0.45	230
12	626	9.0	1.2	230

Note *Test by pulse voltage

**S : Set coil (pin No.1 ... (+) , pin No.12 ...(-)) R : Reset coil (pin No.6...(+) , pin No.7...(-))

The latch type relays should be initialized at appointed position before using, and should be energized to specific polarity by above polarity to avoid wrong operation.

Any special coil requirement, please contact NEC TOKIN for availability.

SAFETY STANDARD AND RATING

UL Recognized (UL508)* File No E73266	CSA Certified (CSA C22.2 No14) File No LR46266
30 VDC, 2 A (Resistive) 110 VDC, 0.3 A (Resistive) 125 VAC, 0.5 A (Resistive)	

* Spacing: UL114, UL478

TUV Certificate	
(IEC61810/ EN61810)	(EN61810)
No. R 9750561	No. R 9751153
ND Type (Non-latch and Single coil latch)	NU,NJ,NUH,NUX Type (Non-latch and Single coil latch)
Creepage and clearance of coil to contact is more than 2 mm. (According to EN60950)	
Supplementary insulation class	Basic insulation class



- All specifications in this catalog and production status of products are subject to change without notice. Prior to the purchase, please contact NEC TOKIN for updated product data.
- Please request for a specification sheet for detailed product data prior to the purchase.
- Before using the product in this catalog, please read "Precautions" and other safety precautions listed in the printed version catalog.

RECOMMENDED RELAY DRIVE CONDITIONS

Drive under conditions. If it is impossible, please inquire to NEC TOKIN.

Non-latch type	Voltage: within $\pm 5\%$ of nominal voltage	Ambient temperature - 40 to + 85°C
Single coil latch type Double coil latch type	Square pulse (rise and fall time is rapid) Pulse height : within $\pm 5\%$ of nominal voltage Pulse width : More than 10 ms	

PART NUMBER SYSTEM

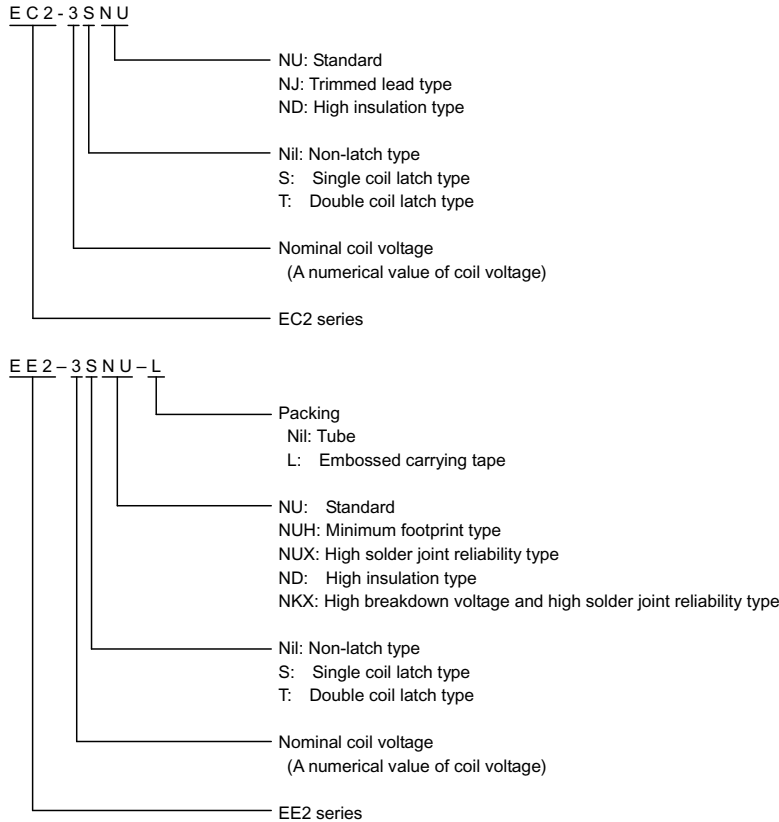

- All specifications in this catalog and production status of products are subject to change without notice. Prior to the purchase, please contact NEC TOKIN for updated product data.
- Please request for a specification sheet for detailed product data prior to the purchase.
- Before using the product in this catalog, please read "Precautions" and other safety precautions listed in the printed version catalog.

ORDERING PART NUMBERS

EC2 series

Option		Nominal Coil Voltage (VDC)	Coil Type		
Terminal	Packing		Non-latch	Single Coil Latch	Double Coil Latch
Standard	Tube	3	EC2-3NU	EC2-3SNU	EC2-3TNU
		4.5	EC2-4.5NU	EC2-4.5SNU	EC2-4.5TNU
		5	EC2-5NU	EC2-5SNU	EC2-5TNU
		9	EC2-9NU	EC2-9SNU	EC2-9TNU
		12	EC2-12NU	EC2-12SNU	EC2-12TNU
		24	EC2-24NU	EC2-24SNU	EC2-24TNU
Trimmed lead	Tube	3	EC2-3NJ	EC2-3SNJ	EC2-3TNJ
		4.5	EC2-4.5NJ	EC2-4.5SNJ	EC2-4.5TNJ
		5	EC2-5NJ	EC2-5SNJ	EC2-5TNJ
		9	EC2-9NJ	EC2-9SNJ	EC2-9TNJ
		12	EC2-12NJ	EC2-12SNJ	EC2-12TNJ
		24	EC2-24NJ	EC2-24SNJ	EC2-24TNJ

EC2 series High Insulation Type (ND Type)

Option		Nominal Coil Voltage (VDC)	Coil Type	
Terminal	Packing		Non-latch	Single Coil Latch
Standard	Tube	3	EC2-3ND	EC2-3SND
		4.5	EC2-4.5ND	EC2-4.5SND
		5	EC2-5ND	EC2-5SND
		9	EC2-9ND	EC2-9SND
		12	EC2-12ND	EC2-12SND
		24	EC2-24ND	EC2-24SND

EE2 series

Option		Nominal Coil Voltage (VDC)	Coil Type		
Terminal	Packing		Non-latch	Single Coil Latch	Double Coil Latch
Standard	Tube	3	EE2-3NU	EE2-3SNU	EE2-3TNU
		4.5	EE2-4.5NU	EE2-4.5SNU	EE2-4.5TNU
		5	EE2-5NU	EE2-5SNU	EE2-5TNU
		9	EE2-9NU	EE2-9SNU	EE2-9TNU
		12	EE2-12NU	EE2-12SNU	EE2-12TNU
		24	EE2-24NU	EE2-24SNU	EE2-24TNU
	Taping	3	EE2-3NU-L	EE2-3SNU-L	EE2-3TNU-L
		4.5	EE2-4.5NU-L	EE2-4.5SNU-L	EE2-4.5TNU-L
		5	EE2-5NU-L	EE2-5SNU-L	EE2-5TNU-L
		9	EE2-9NU-L	EE2-9SNU-L	EE2-9TNU-L
		12	EE2-12NU-L	EE2-12SNU-L	EE2-12TNU-L
		24	EE2-24NU-L	EE2-24SNU-L	EE2-24TNU-L
Minimum footprint	Tube	3	EE2-3NUH	EE2-3SNUH	EE2-3TNUH
		4.5	EE2-4.5NUH	EE2-4.5SNUH	EE2-4.5TNUH
		5	EE2-5NUH	EE2-5SNUH	EE2-5TNUH
		9	EE2-9NUH	EE2-9SNUH	EE2-9TNUH
		12	EE2-12NUH	EE2-12SNUH	EE2-12TNUH
		24	EE2-24NUH	EE2-24SNUH	EE2-24TNUH



- All specifications in this catalog and production status of products are subject to change without notice. Prior to the purchase, please contact NEC TOKIN for updated product data.
- Please request for a specification sheet for detailed product data prior to the purchase.
- Before using the product in this catalog, please read "Precautions" and other safety precautions listed in the printed version catalog.

Minimum footprint	Taping	3	EE2-3NUH-L	EE2-3SNUH-L	EE2-3TNUH-L
		4.5	EE2-4.5NUH-L	EE2-4.5SNUH-L	EE2-4.5TNUH-L
		5	EE2-5NUH-L	EE2-5SNUH-L	EE2-5TNUH-L
		9	EE2-9NUH-L	EE2-9SNUH-L	EE2-9TNUH-L
		12	EE2-12NUH-L	EE2-12SNUH-L	EE2-12TNUH-L
		24	EE2-24NUH-L	EE2-24SNUH-L	EE2-24TNUH-L
High solder joint reliability	Tube	3	EE2-3NUX	EE2-3SNUX	EE2-3TNUX
		4.5	EE2-4.5NUX	EE2-4.5SNUX	EE2-4.5TNUX
		5	EE2-5NUX	EE2-5SNUX	EE2-5TNUX
		9	EE2-9NUX	EE2-9SNUX	EE2-9TNUX
		12	EE2-12NUX	EE2-12SNUX	EE2-12TNUX
		24	EE2-24NUX	EE2-24SNUX	EE2-24TNUX
	Taping	3	EE2-3NUX-L	EE2-3SNUX-L	EE2-3TNUX-L
		4.5	EE2-4.5NUX-L	EE2-4.5SNUX-L	EE2-4.5TNUX-L
		5	EE2-5NUX-L	EE2-5SNUX-L	EE2-5TNUX-L
		9	EE2-9NUX-L	EE2-9SNUX-L	EE2-9TNUX-L
		12	EE2-12NUX-L	EE2-12SNUX-L	EE2-12TNUX-L
		24	EE2-24NUX-L	EE2-24SNUX-L	EE2-24TNUX-L

EE2 series High Insulation Type (ND Type)

Option		Nominal Coil Voltage (VDC)	Coil Type	
Terminal	Packing		Non-latch	Single Coil Latch
Standard	Tube	3	EE2-3ND	EE2-3SND
		4.5	EE2-4.5ND	EE2-4.5SND
		5	EE2-5ND	EE2-5SND
		9	EE2-9ND	EE2-9SND
		12	EE2-12ND	EE2-12SND
		24	EE2-24ND	EE2-24SND
	Taping	3	EE2-3ND-L	EE2-3SND-L
		4.5	EE2-4.5ND-L	EE2-4.5SND-L
		5	EE2-5ND-L	EE2-5SND-L
		9	EE2-9ND-L	EE2-9SND-L
		12	EE2-12ND-L	EE2-12SND-L
		24	EE2-24ND-L	EE2-24SND-L

EE2 series High Breakdown Voltage Type (NKX Type)

Option		Nominal Coil Voltage (VDC)	Coil Type
Terminal	Packing		Non-latch
High solder joint reliability	Tube	3	EE2-3NKX
		4.5	EE2-4.5NKX
		12	EE2-12NKX
	Taping	3	EE2-3NKX-L
		4.5	EE2-4.5NKX-L
		12	EE2-12NKX-L



● All specifications in this catalog and production status of products are subject to change without notice. Prior to the purchase, please contact NEC TOKIN for updated product data.
 ● Please request for a specification sheet for detailed product data prior to the purchase.
 ● Before using the product in this catalog, please read "Precautions" and other safety precautions listed in the printed version catalog.

PERFORMANCE DATA

☐ COIL TEMPERATURE RISE

Temperature is measured by coil resistance

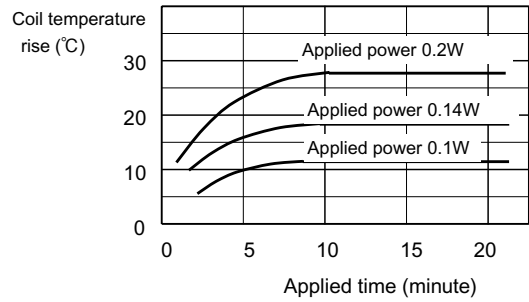
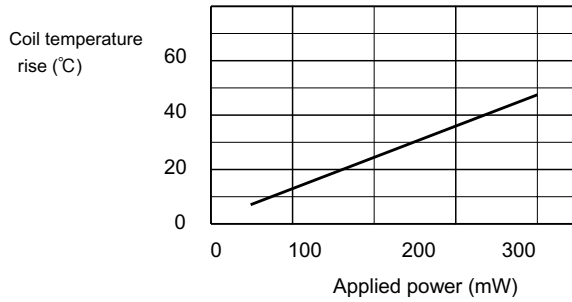

☐ SWITCHING CAPACITY

These are maximum value.

Inquire with NEC TOKIN for maximum values under continuous

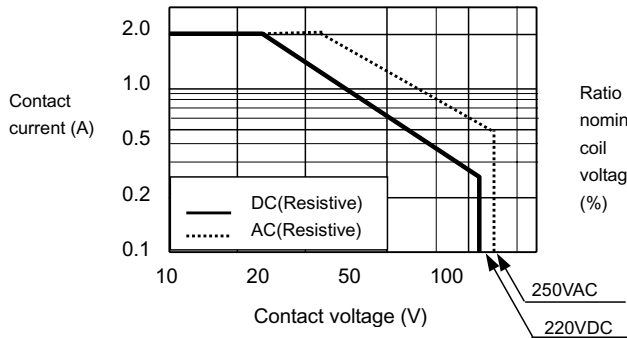

☐ MAXIMUM COIL VOLTAGE

This is a maximum value of permissible alteration.

Inquire with NEC TOKIN under continuous use.

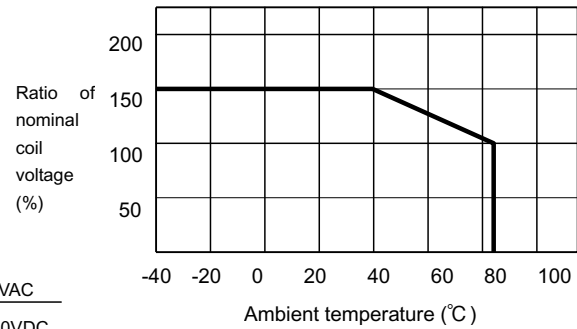

☐ APPLIED VOLTAGE VS. TIMING (Sample:EE2-5NU)

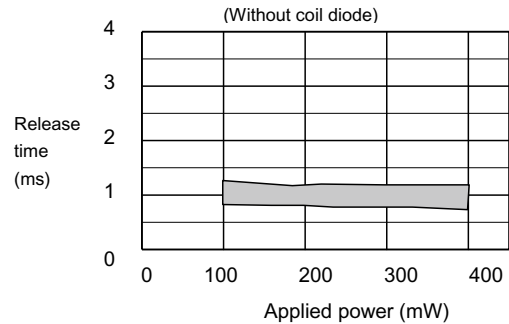
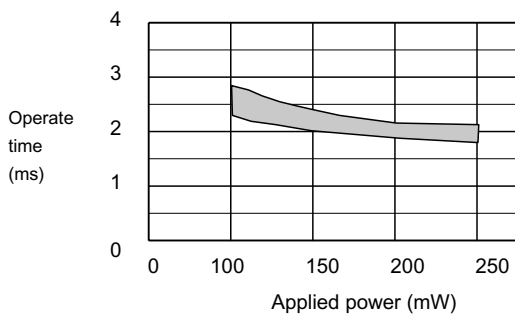

● All specifications in this catalog and production status of products are subject to change without notice. Prior to the purchase, please contact NEC TOKIN for updated product data.
 ● Please request for a specification sheet for detailed product data prior to the purchase.
 ● Before using the product in this catalog, please read "Precautions" and other safety precautions listed in the printed version catalog.

OPERATE AND RELEASE VOLTAGE VS.AMBIENT TEMPERATURE

This shows a typical change of operate (release) voltage. The value of must operate is estimated, so coil voltage must be applied more than this value for safety operation. For hot start operation, please inquire with NEC TOKIN.

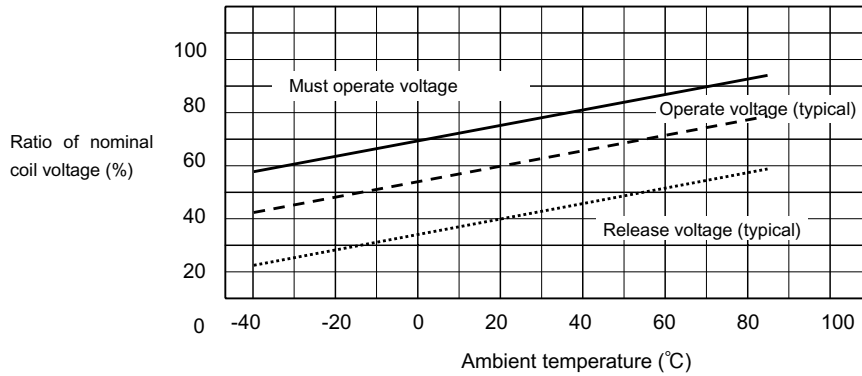

RUNNING TEST (Non load)

(Load: none, Drive:5VDC, 50Hz, 50%duty, Ambient temperature :room temperature, Sample:EE2-5NU ,20pieces)

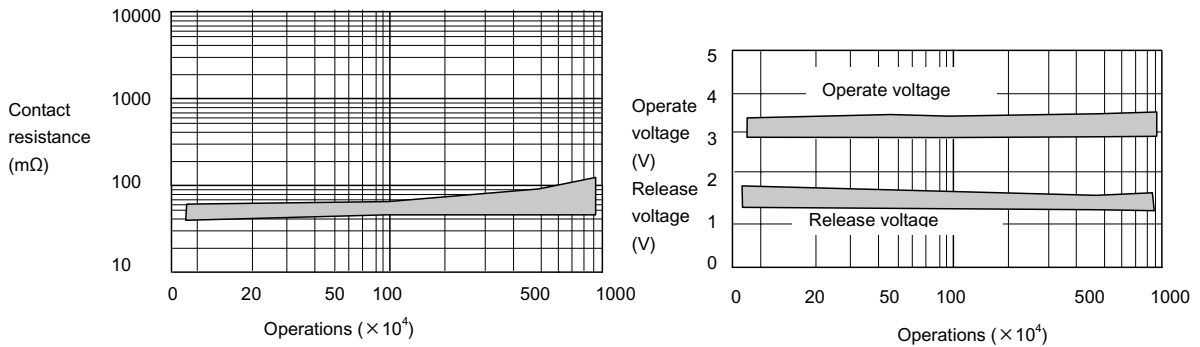

RUNNING TEST(Load)

(Load:50VDC 0.1A resistive, Drive:5VDC,5Hz,50%duty,Ambient temperature:85°C, Sample:EE2-5NU ,10pieces)

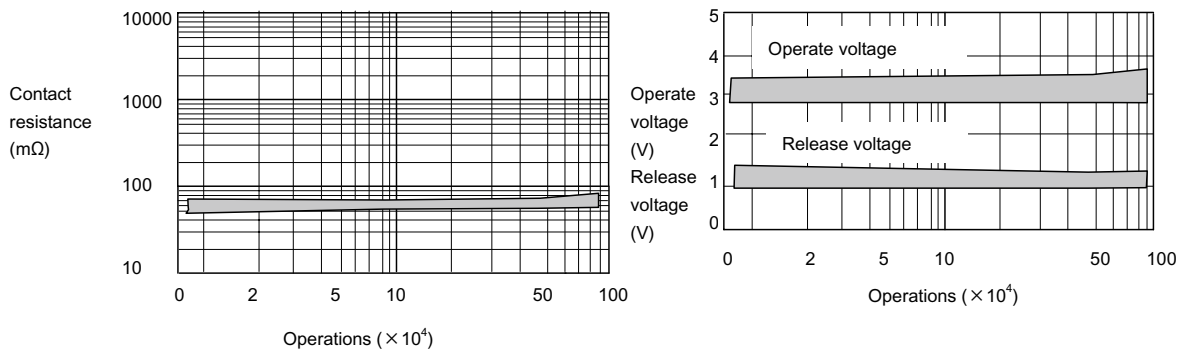

● All specifications in this catalog and production status of products are subject to change without notice. Prior to the purchase, please contact NEC TOKIN for updated product data.
 ● Please request for a specification sheet for detailed product data prior to the purchase.
 ● Before using the product in this catalog, please read "Precautions" and other safety precautions listed in the printed version catalog.

□ BREAKDOWN VOLTAGE

Sample: EC2-5NU 10pieces

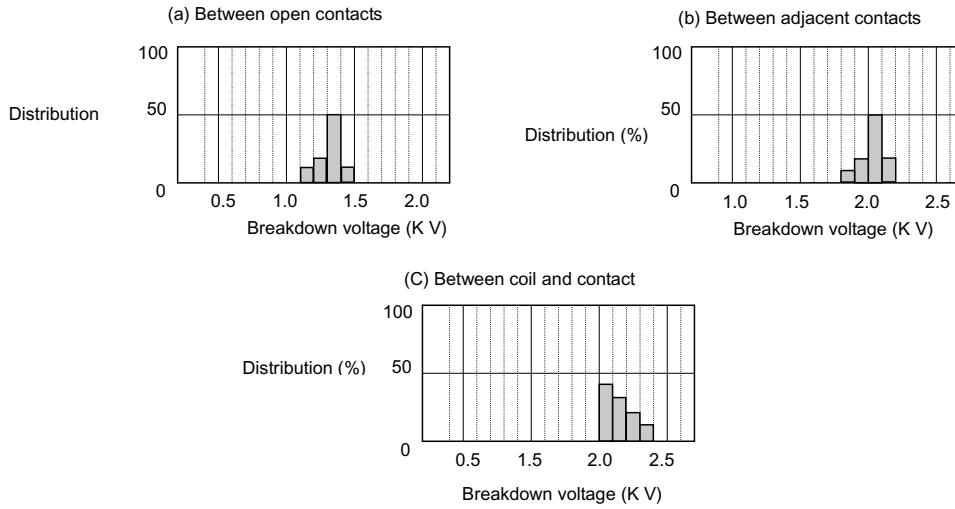

□ ALTERNATION OF VOLTAGE IN DENSE MOUNTING (Magnetic interference)

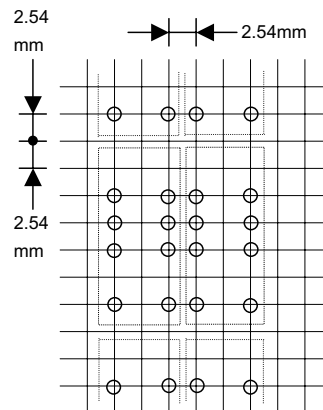
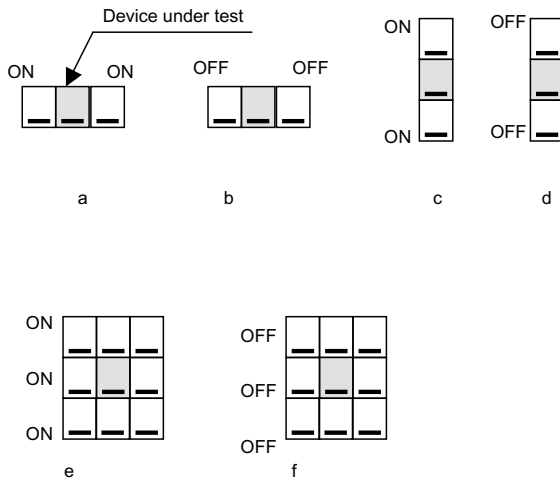
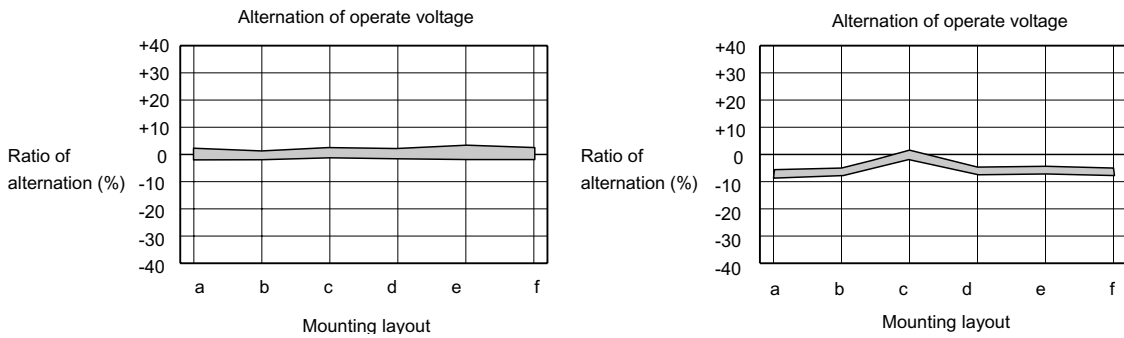

● All specifications in this catalog and production status of products are subject to change without notice. Prior to the purchase, please contact NEC TOKIN for updated product data.
 ● Please request for a specification sheet for detailed product data prior to the purchase.
 ● Before using the product in this catalog, please read "Precautions" and other safety precautions listed in the printed version catalog.

PACKING DIMENSION (Unit: mm)

TUBE PACKING (EC2/EE2)

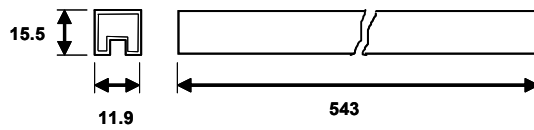

35 pieces / Tube (anti-static)

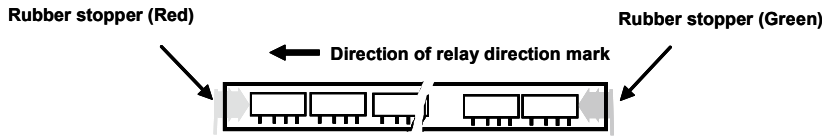

TAPE PACKING (EE2)

APPEARANCE

Number of storage: 500 pieces / Reel
Reel diameter: 380mm

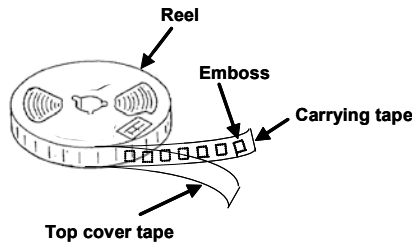

TAPE DIMENSIONS

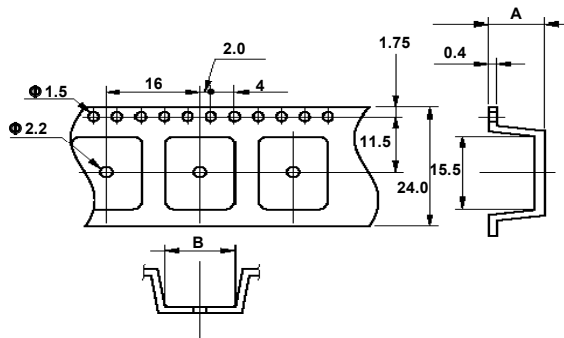

	A	B
EE2-xxNU-L	Max.10.9	10.0
EE2-xxND-L		
EE2-xxNUX-L		
EE2-xxNKX-L		
EE2-xxNUH-L	Max.11.1	8.0

RELAY DIRECTION MARK AND TAPE CARRYING DIRECTION

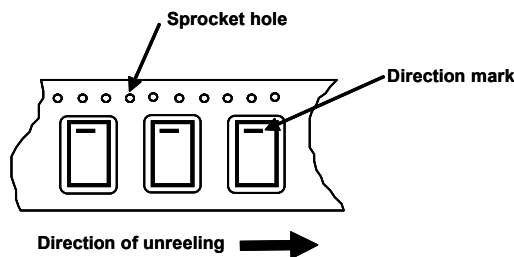

● All specifications in this catalog and production status of products are subject to change without notice. Prior to the purchase, please contact NEC TOKIN for updated product data.
● Please request for a specification sheet for detailed product data prior to the purchase.
● Before using the product in this catalog, please read "Precautions" and other safety precautions listed in the printed version catalog.

SOLDERING TEMPERATURE CONDITION

THROUGH-HOLE MOUNTING (EC2)

1. Automatic soldering

Preheating: 110~ 120°C /110 sec. (max.)
 Solder temperature: 260°C max.
 Solder time: 5 seconds max.

Note: NEC TOKIN recommends cooling down a printed circuit board less than 110°C within 40 seconds after soldering.

2. Manual soldering

Solder temperature: 350°C max.
 Solder time: 3 seconds max.

SURFACE-MOUNTING TYPE (EE2)

IRS Method

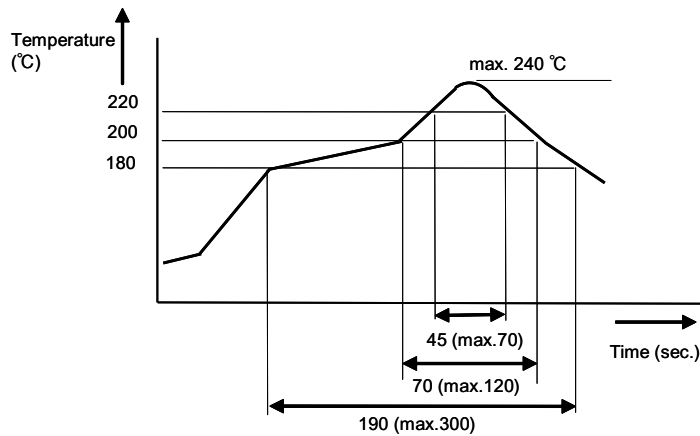

Note:

1. Temperature profile shows printed circuit board surface temperature on the relay terminal portion.
2. Check the actual soldering condition to use other method except above mentioned temperature profiles.



● All specifications in this catalog and production status of products are subject to change without notice. Prior to the purchase, please contact NEC TOKIN for updated product data.
 ● Please request for a specification sheet for detailed product data prior to the purchase.
 ● Before using the product in this catalog, please read "Precautions" and other safety precautions listed in the printed version catalog.

NOTE ON CORRECT USE

1. Notes on contact load

Make sure that the contact load is within the specified range; otherwise, the lifetime of the contacts will be shortened considerably.

Note that the running performance shown is an example, and that it varies depending on parameters such as the type of load, switching frequency, driver circuit, and ambient temperature under the actual operating conditions.

Evaluate the performance by using the actual circuit before using the relay.

2. Driving relays

- If the internal connection diagram of a relay shows + and - symbols on the coil, apply the rated voltage to the relay in the specified direction. If a rippled DC current source is used, abnormalities such as beat at the coil may occur.

- The maximum voltage that can be applied to the coil of the relay varies depending on the ambient temperature.

Generally, the higher the voltage applied to the coil, the shorter the operating time. Note, however, that a high voltage also increases the bounce of the contacts and the contact opening and closing frequency, which may shorten the lifetime of the contacts.

- If the driving voltage waveform of the relay coil rises and falls gradually, the inherent performance of the relay may not be fully realized. Make sure that the voltage waveform instantaneously rises and falls as a pulse.

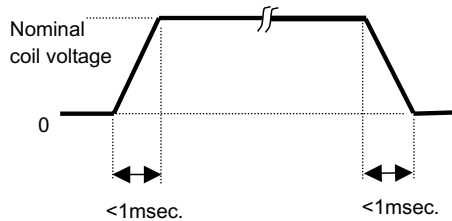

- For a latching relay, apply a voltage to the coil according to the polarity specified in the internal connection diagram of the relay.

- If a current is applied to the coil over a long period of time, the coil temperature rises, promoting generation of organic gas inside the relay, which may result in faulty contacts. In this case, use of a latching relay is recommended.

- The operating time and release time indicate the time required for each contact to close after the voltage has been applied to or removed from the coil. However, because the relay has a mechanical structure, a bounce state exists at the end of the operating and release times. Furthermore, because additional time is required until the contact stabilizes after being in a high-resistance state, care must be taken when using the relay at high speeds.

3. Operating environment

- Make sure that the relay mounted in the application set is used within the specified temperature range. Use of a relay at

a temperature outside this range may adversely affect insulation or contact performance.

- If the relay is used for a long period of time in highly humid (RH 85% or higher) environment, moisture may be absorbed into the relay. This moisture may react with the NOx and SOx generated by glow discharges that occur when the contacts are opened or closed, producing nitric or sulfuric acid. If this happens, the acid produced may corrode the metallic parts of the relay, causing operational malfunction.

- If any material containing silicon (silicon rubber, silicon oil, and silicon based coating material) is used in the neighborhood of relay, there is some possibility that these materials will emit silicon gas that will penetrate the relay. In this case, the switching contact may generate silicon compounds on the surface of contacts. This silicon compound may result in contact failure. Avoid use of relay in such an environment.

- Because the operating temperature range varies depending on the humidity, use the relay in the temperature range illustrated in the figure below. Prevent the relay from being frozen and avoid the generation of condensation.

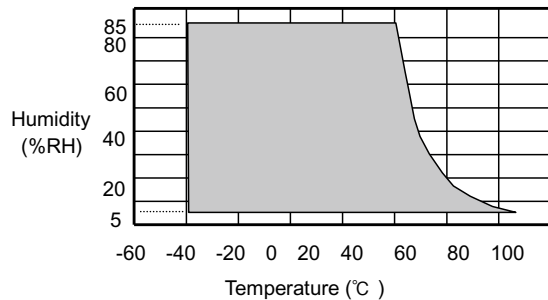

- The relay maintains constant sealability under normal atmospheric pressure (810 to 1,200 hpa). Its sealability may be degraded or the relay may be deformed and malfunction if it is used under barometric conditions exceeding the specified range.

- The same applies when the relay is stored or transported. Keep the upper-limit value of the temperature to which the relay is exposed after it is removed from the carton box to within 50°C .

- Permanent magnets are used in polarized relays. For this reason, when magnets, transformers, or speakers are located nearby the relay characteristics may change and faulty operations may result.

- If excessive vibration or shock is applied to the relay, it may malfunction and the contacts remain closed. Vibration or shock applied to the relay during operation may cause considerable damage to or wearing of the contacts. Note that operation of a snap switch mounted close to the relay or shock due to the operation of magnetic solenoid may also cause malfunctioning.



● All specifications in this catalog and production status of products are subject to change without notice. Prior to the purchase, please contact NEC TOKIN for updated product data.
 ● Please request for a specification sheet for detailed product data prior to the purchase.
 ● Before using the product in this catalog, please read "Precautions" and other safety precautions listed in the printed version catalog.

4. Notes on mounting relays

- When mounting a relay onto a PC board using an automatic chip moulder, if excessive force is applied to the cover of the relay when the relay is chucked or inserted, the cover may be damaged or the characteristics of the relay degraded. Keep the force applied to the relay to within 1 kg.
- Avoid bending the pins to temporarily secure the relay to the PC board. Bending the pins may degrade sealability or adversely affect the internal mechanism.
- It is recommended to solder the relay onto a PC board under the following conditions:
 - <1> Reflow soldering
Refer to the recommended soldering temperature profile.
 - <2> Flow soldering
Solder temperature: 260°C max., Time: 5 seconds max.
Preheating: 110~ 120°C /110 sec. (max.)
 - <3> Manual soldering
Solder temperature: 350°C , Time: 2~3 seconds
- Ventilation immediately after soldering is recommended. Avoid immersing the relay in cleaning solvent immediately after soldering due to the danger of thermal shock being applied to the relay.
- Use an alcohol-based or water-based cleaning solvent. Never use thinner and benzene because they may damage the relay housing.
- Do not use ultrasonic cleaning because the vibration energy generated by the ultrasonic waves may cause the contacts to remain closed.

5. Handling

- Relays are packaged in magazine cases for shipment. If a space is created in the case after some relays have been removed, be sure to insert a stopper to secure the remaining relays in the case. If relays are not well secured, vibration during transportation may cause malfunctioning of the contacts.
- Exercise care in handling the relay so as to avoid dropping it or allowing it to fall. Do not use a relay that has been dropped. If a relay drops from a workbench to the floor, a shock of 9,800 m/s² (1,000 G) or more is applied to the relay, possibly damaging its functions. Even if a light shock has been applied to the relay, thoroughly evaluate its operation before using it.
- Latching relays are factory-set to the reset state for shipment. A latching relay may be set, however, by vibration or shock applied while being transported. Be sure to forcibly reset the relay before using it in the application set. Also note that the relay may be set by unexpected vibration or shock when it is used in a portable set.
- The sealability of a surface-mount (SMT) relay may be lost if the relay absorbs moisture and is then heated during soldering. When storing relays, therefore, observe the following points:
 - <1> For standard packing, please use relays within 12 months after delivery. (Storage conditions: 30°C / 60% RH)
 If the relays have moisture absorption, dehumidify as follows.
 - Tape packing: 50 ± 5°C , 200~300 hours.
 - Simple relay: 85 ± 5°C , 48 hours.
- <2> For MBB packing, please use relays within 2 years after

delivery.

- (Storage conditions: 30°C / 60% RH)
- After open MBB packing, please use within 3 months.
- (Storage conditions: 30°C / 60% RH)



- All specifications in this catalog and production status of products are subject to change without notice. Prior to the purchase, please contact NEC TOKIN for updated product data.
- Please request for a specification sheet for detailed product data prior to the purchase.
- Before using the product in this catalog, please read "Precautions" and other safety precautions listed in the printed version catalog.

No part of this document may be copied or reproduced in any form or by any means without the prior written consent of NEC TOKIN Corporation. NEC TOKIN Corporation assumes no responsibility for any errors which may appear in this document.

NEC TOKIN Corporation does not assume any liability for infringement of patents, copyrights or other intellectual property rights of third parties by or arising from use of a device described herein or any other liability arising from use of such device. No license, either express, implied or otherwise, is granted under any patents, copyrights or other intellectual property rights of NEC TOKIN Corporation or others. While NEC TOKIN Corporation has been making continuous effort to enhance the reliability of its electronic components, the possibility of defects cannot be eliminated entirely. To minimize risks of damage or injury to persons or property arising from a defect in an NEC TOKIN electronic component, customers must incorporate sufficient safety measures in its design, such as redundancy, fire-containment, and anti-failure features. NEC TOKIN devices are classified into the following three quality grades: "Standard", "Special", and "Specific". The Specific quality grade applies only to devices developed based on a customer designated "quality assurance program" for a specific application. The recommended applications of a device depend on its quality grade, as indicated below. Customers must check the quality grade of each device before using it in a particular application.

Standard: Computers, office equipment, communications equipment, test and measurement equipment, audio and visual equipment, home electronic appliances, machine tools, personal electronic equipment and industrial robots

Special: Transportation equipment (automobiles, trains, ships, etc.), traffic control systems, anti-disaster systems, anti-crime systems, safety equipment and medical equipment (not specifically designed for life support)

Specific: Aircrafts, aerospace equipment, submersible repeaters, nuclear reactor control systems, life support systems or medical equipment for life support, etc.

The quality grade of NEC TOKIN devices is "Standard" unless otherwise specified in NEC TOKIN's Data Sheets or Data Books. If customers intend to use NEC TOKIN devices for applications other than those specified for Standard quality grade, they should contact an NEC TOKIN sales representative in advance.

(Note)

(1) "NEC TOKIN" as used in this statement means NEC TOKIN Corporation and also includes its majority owned subsidiaries.

(2) "NEC TOKIN electronic component products" means any electronic component product developed or manufactured by or for NEC TOKIN (as defined above).



- All specifications in this catalog and production status of products are subject to change without notice. Prior to the purchase, please contact NEC TOKIN for updated product data.
- Please request for a specification sheet for detailed product data prior to the purchase.
- Before using the product in this catalog, please read "Precautions" and other safety precautions listed in the printed version catalog.

单击下面可查看定价，库存，交付和生命周期等信息

[>>NEC-TOKIN/KEMET](#)