



General

- Slow Blow
- 3.10mm×1.55mm physical size
- Thick film manufacturing method, ceramic substrate, silver fusing element
- -50°C~125°C operating temperature
- Excellent environmental integrity
- RoHS compliant
- Halogen-free

Agency / Certificate Information

Agency	File Number	Ampere Range
	JDYX2.E319512	1A~7A
	JDYX8.E319512	1A~7A

Application

- Battery pack
- LED driver
- Car charger
- Portable devices (battery charger, etc.)
- Game equipment
- LCD monitor, LCD modules
- Wireless base station

Ordering Information

Part Number	Marking	Current Rating (A)	Voltage Rating (V)	Interrupting Rating	Max Cold DCR* (Ω)	Typical I ² T** (A ² S)
S1206-SD-1.0A	H	1.0	63	50A 63V DC 63V AC	0.380	0.245
S1206-SD-1.5A	K	1.5			0.200	0.294
S1206-SD-2.0A	N	2.0			0.105	0.788
S1206-SD-2.5A	O	2.5			0.078	1.149
S1206-SD-3.0A	P	3.0			0.045	2.300
S1206-SD-3.5A	R	3.5			0.037	2.563
S1206-SD-4.0A	S	4.0			0.028	3.667
S1206-SD-5.0A	T	5.0			0.020	4.260
S1206-SD-6.0A	6	6.0			0.016	9.848
S1206-SD-7.0A	U	7.0			0.009	11.176

* Measured at ≤10% rated current and 25°C

** Melting I²T at 10 times of rated current

Catalog Symbol

S 1206-SD-3.0A

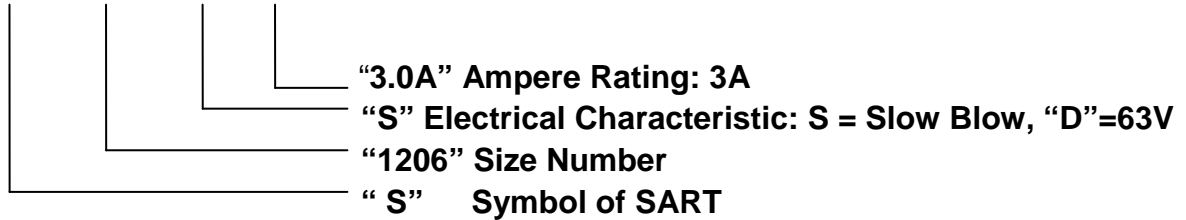

Dimensions

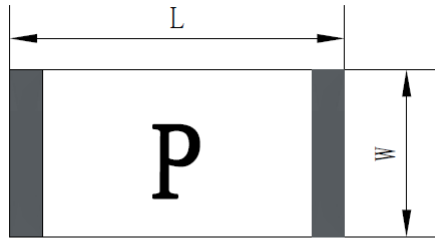

L(mm)	W(mm)	T(mm)	B(mm)
3.10±0.20	1.55±0.20	0.55±0.20	0.50±0.20

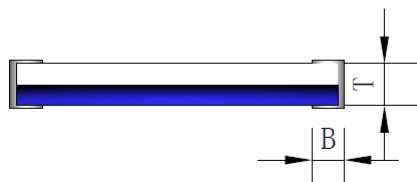

Recommended Land Patterns

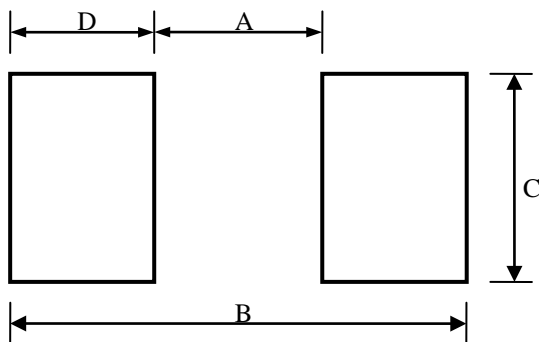

Materials

Components	Material
Substrate	Ceramic
Terminations	Silver over-plated with tin (100%)
Element	Silver or Silver / Palladium

Dimensions	A(mm)	B(mm)	C(mm)	D(mm)
Spec	2.00±0.30	4.40±0.50	2.40±0.30	1.20±0.30

Time Current Curve

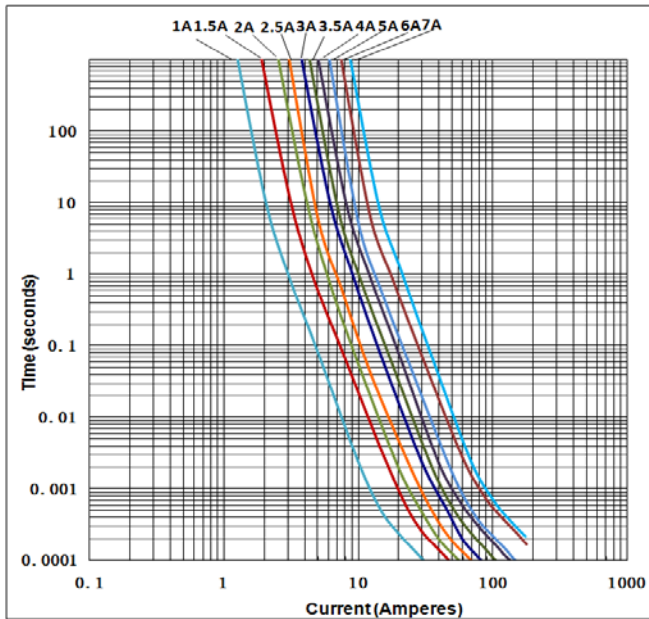

I²T vs Time Curve

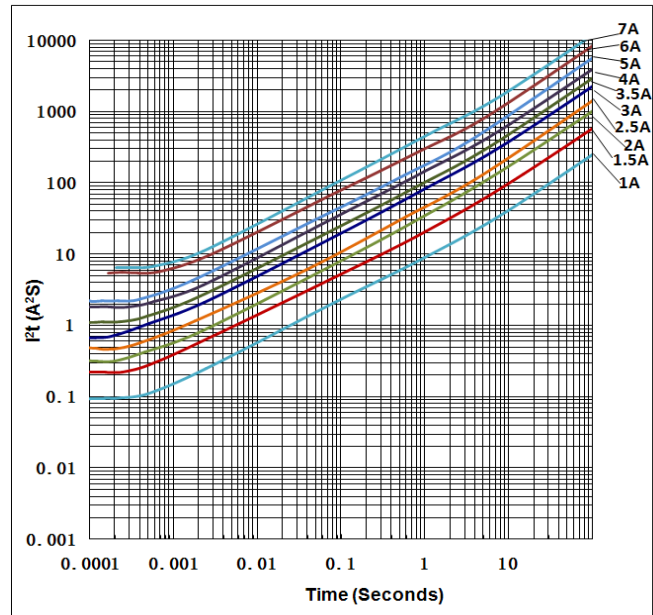

Electrical Characteristics

Ampere Rating	% of Current Rating	Opening Time
1A-7A	100%	>4 hours
1A-7A	200%	≤60 sec
1A-7A	1000%	>1.0ms

Temperature Derating Curve

- The current carrying capacity will be affected by ambient temperature which was showed in the figure.
- This current derating curve is for fusing characteristics.

Example,

Work Temp:80°C,

Temp derating factor = 91%

$I_{actual} = I_{normal} / 0.91$

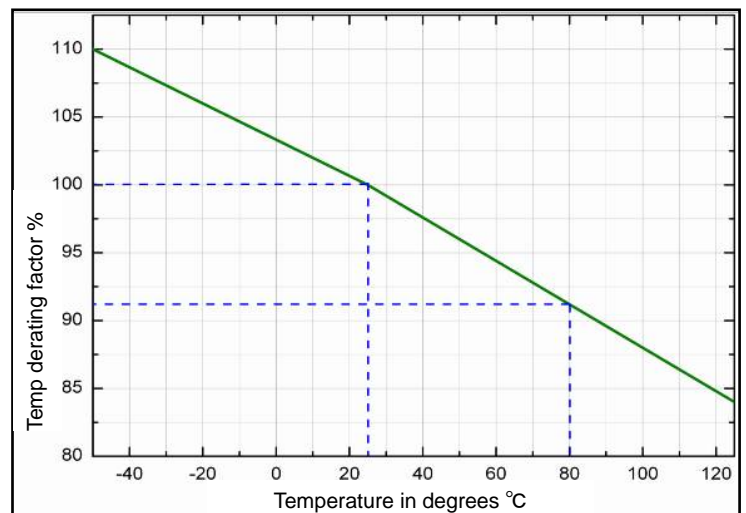

Reliability Test

Item	Test condition / Methods	Performance	Standard
Voltage Drop	100% In; Temperature in fuse was stabilized	Deviation between the mean value:<15%	IEC 60127-1
Time/Current	100% In	No Fusing;4hours Min.	Refer to SART Spec
	200% In	≤60 sec	
	1000% In	>1.0ms	
Endurance Test	100% In, 1h on,15min off, 100 cycles; followed by 1h at 125%In	$ \Delta R < 10\%$ Legible appearance	IEC 60127-1
Maximum Sustained Dissipation	125%In, during the last 10min of the endurance test	changed with current rating	IEC 60127-1
Temperature Rise	100%In	$ \Delta T < 75^\circ\text{C}$	UL248-14
Interrupting Ability	50A/63V DC 50A /63V AC	Without permanent arcing, ignition and bursting of fuse link	UL248-14
Solderability	240°C±5°C,3sec±0.5sec	95% coverage Min.	IEC60127-4 IEC60068-2-20 MIL-STD-202
Resistance to Soldering	260°C±5°C,10sec±0.5sec	$ \Delta R < 10\%$ Legible appearance	MIL-STD-202 IEC60127-4
Bending Test	Distance between holding points: 90mm Bending: 1mm ; time:10sec	$ \Delta R < 10\%$ No mechanical damages	IEC 60127-4
High Temperature Operating Life	70°C±2°C, 96hours, at 60% In	$ \Delta R < 10\%$; no fusing	MIL-STD-202 Method 108
Low Temperature Storage	-55°C±2 °C, 96hours	$ \Delta R < 10\%$	IEC60068-2-1
High Temperature Storage	125°C±2 °C, 96hours	$ \Delta R < 10\%$	IEC60068-2-2
Humidity (steady state)	40°C±2°C, 90%~95%RH, 1000hours	$ \Delta R < 10\%$	MIL-STD-202 Method 103
Salt Spray	5% salt solution, 48hours exposure	$ \Delta R < 10\%$ Legible appearance	MIL-STD-202 Method 101
Thermal Shock	5 cycles between -55°C/+125°C, 60 minutes ; each extreme	$ \Delta R < 10\%$ No mechanical damages	IEC 60068-2-14

Recommended Solder Curve

1. Infrared Reflow:

Temperature: 260°C

Time: 5sec Max.

Recommend Reflow profile

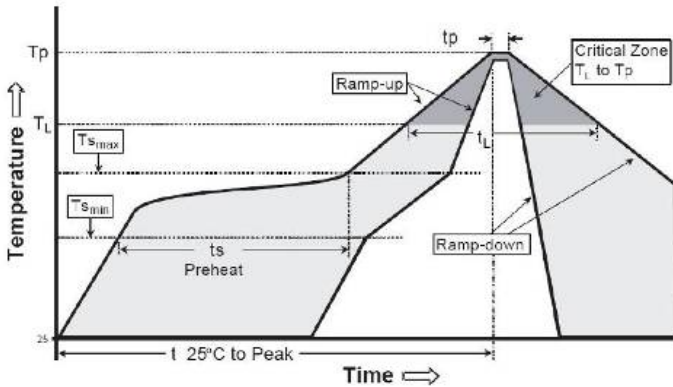

Profile Feature	Pb-Free Assembly
Average Ramp-Up Rate ($T_{s_{max}}$ to T_p)	3°C/s Max.
Preheat Temperature Min ($T_{s_{min}}$)	150°C
Temperature Max ($T_{s_{max}}$)	200°C
Time ($T_{s_{min}}$ to $T_{s_{max}}$)	60sec~120sec
Peak Temperature (T_p)	260°C
Time within 5°C of actual Peak Temperature (T_p)	5sec
Melting tin time (T_L)	20sec~30sec
Ramp-Down Rate	6°C/s Max.
Time 25°C to Peak Temperature	8 minutes Max.

2. Wave soldering

Reservoir Temperature: 260°C

Time in Reservoir: 10sec Max.

3. Hand Soldering

Temperature: 350°C

Time: 5sec Max.

Packaging

5,000 pieces of fuses in paper taper and reeled on a 178mm(7 inch) reel

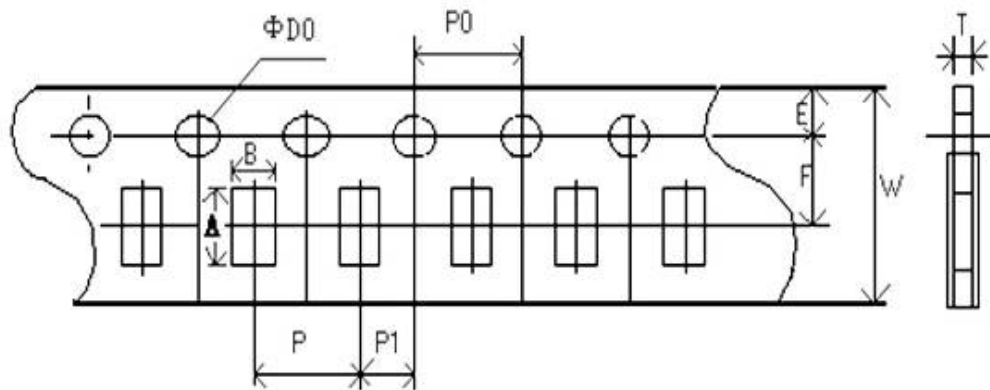

Type	A(mm)	B(mm)	W(mm)	F(mm)	E(mm)
Spec	3.50±0.20	1.90±0.20	8.00±0.20	3.50±0.05	1.75±0.10
Type	P(mm)	P0(mm)	P1(mm)	D0(mm)	T(mm)
Spec	4.00±0.10	4.00±0.10	2.00±0.05	1.50±0.10	0.75±0.10

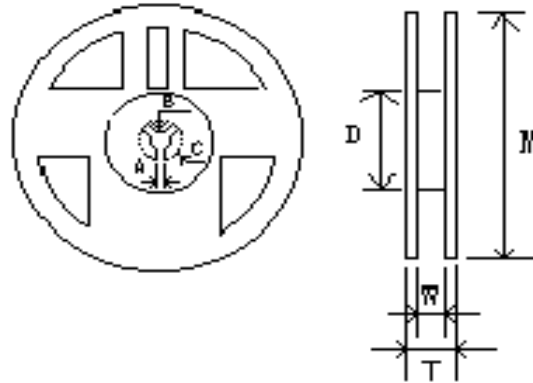

Type	M(mm)	W(mm)	T(mm)	A(mm)	B(mm)	C(mm)	D(mm)
Spec	178.00±2.00	9.50±1.00	12.50±1.50	2.00±0.50	13.00±0.50	21.00±0.50	58.00±2.00

Storage

- The ambient temperature shall between 5°C~30°C.
- The relative humidity recommended for storage is between 25%~60%.
- Sealed plastic bags with desiccant shall be used to reduce the oxidation of the termination and shall only be opened prior to use. The products shall not be stored in areas where harmful gases containing sulfur or chlorine are present.

单击下面可查看定价，库存，交付和生命周期等信息

[>>SART\(萨特\)](#)