

1. 適用範圍 / SCOPE

2000 系列保險絲，適用於一般電子設備。
2000 series Fuse, used in electronic equipment.

2. 產品型號 / TYPE

例「example」：



- ① 系列號 / Series Number
- ② 延時性 T / Time-Lag Type
- ③ 額定電流 / Rated Current
- ④ 額定電壓 / Rated Voltage
- ⑤ 認證符號 / Approved Symbol















3. 額定電流和額定電壓 / RATED CURRENT AND RATED VOLTAGE

額定電流 / Rated Current:
100mA~6.3A
額定電壓 / Rated Voltage:
250V AC

4. 標示 / MARKING

保險絲上需有下列標示 / The fuses shall have the following marking:

- ① 製造工廠的標識 / Manufacture's Logo: 
- ② 電氣特性 / Electrical Characteristic: T (延時性的保險絲符號 symbol for Time-Lag)
- ③ 額定電流 / Rated Current (A): ___A 或 ___mA
- ④ 額定電壓 / Rated Voltage (V): 250V
- ⑤ 認證符號 / Approval Marks:

100mA~800mA:					
1A~4A :					
5A~6.3A :					
- ⑥ 系列號 / Series No. : 2000

注意 / Note: 對標示的大小和位置沒有規定 / Size and position of the markings shall not be provided.

5. 外觀及形狀 / APPEARANCES AND CONFIGURATION

5-1 外觀不應有顯著的汙點、鐵銹或裂紋; 標示應該容易辨識。

There shall not be any remarkable stain, rust or crack on the appearances; marking shall be easily legible.

5-2 形狀：帶直線引腳的超小型保險絲。

Configuration: Radial leaded Sub-Miniature Fuse.

6. 工程圖和結構 / OUTLINE DRAWING AND STRUCTURE

6-1 工程圖 (單位: mm) / Outline Drawing and Dimensions (Unit: mm)

<編帶包裝>

<Taping>

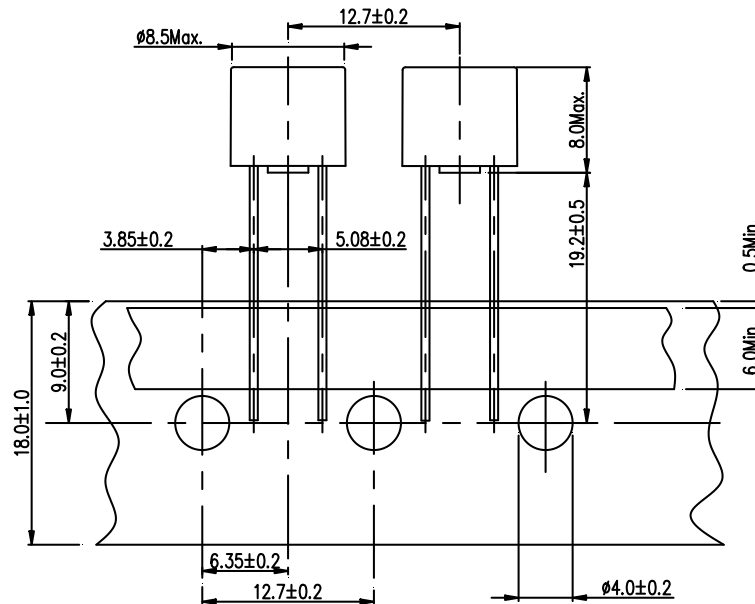

<散裝>

<Bulk>

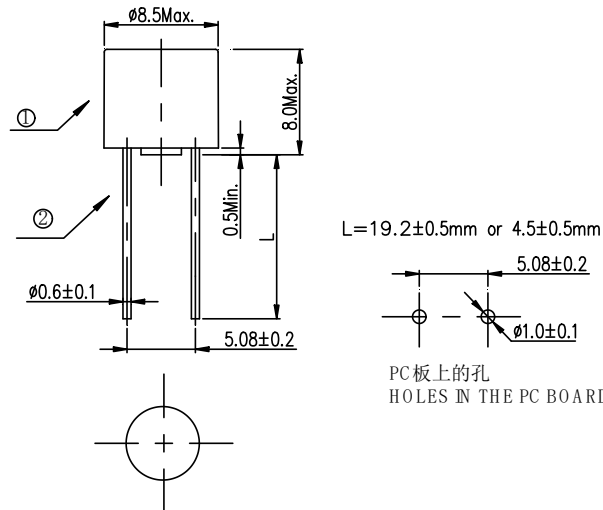

6-2 結構 / Structure

編號 No.	元件 Component	材質 Material	數量 Quantity
1	本體 Body	耐熱性塑膠 Polyamide66 Thermoplastic,UL-94-Vo	1
2	端子 Termination	鍍錫銅線 Tin Plated Copper	2

7. 產品特性 / PRODUCT CHARACTERISTICS

- 7-1 引腳拉力強度 / Lead Pull Strength
10 牛頓 10±1 秒 / 10N for 10±1 Seconds
- 7-2 引腳推力強度 / Lead Thrust Strength
2 牛頓 10±1 秒 / 2N for 10±1 Seconds
- 7-3 可焊性 / Solderability
波峰焊/Wave : 260°C, ≤3s;
烙鐵焊/Soldering Iron: 350±10°C, ≤1s.
- 7-4 耐焊接熱 / Soldering Heat Resistance
波峰焊/Wave : 260°C, 10s;
烙鐵焊/Soldering Iron: 350°C, 3s.

8. 電氣特性 / ELECTRICAL CHARACTERISTICS

- 8-1 熔斷 / 電流特性: Pre-Arcing Time / Current Characteristic (limits)
延遲性保險絲 Time-Lag Type

RATED CURRENT	2.1 IN		2.75 IN		4 IN		10 IN	
	Max.	Min.	Max.	Min.	Max.	Min.	Max.	
100mA to 6.3A	2min	400ms	10s	150ms	3s	20ms	150ms	

- 8-2 分斷能力 / Breaking Capacity

UL	100mA~6.3A	100A/250V AC
VDE	100mA~6.3A	100A/250V AC
SEMKO	100mA~6.3A	100A/250V AC
PSE	1.0A~6.3A	100A/250V AC
CCC	100mA~6.3A	10In or 35A /250V AC , 取較大值 / which is greater
KC	100mA~6.3A	100A/250V AC

9. 環境特性 / ENVIRONMENTAL CHARACTERISTIC

- 9-1 操作溫度範圍: -55°C ~ 125°C / Operating Temperature: -55°C ~ 125°C
若貴司操作環境溫度超出25±5°C範圍, 在選用保險絲規格時,
需考慮操作環境溫度對保險絲的影響。
請參照: 溫度-電流曲線圖。

When choosing the fuse's specification, if the operating environmental temperature beyond the

scope from 20~30°C, you should consider the environmental temperature's affection to fuses.

please refer:

Temperature-Current curve:

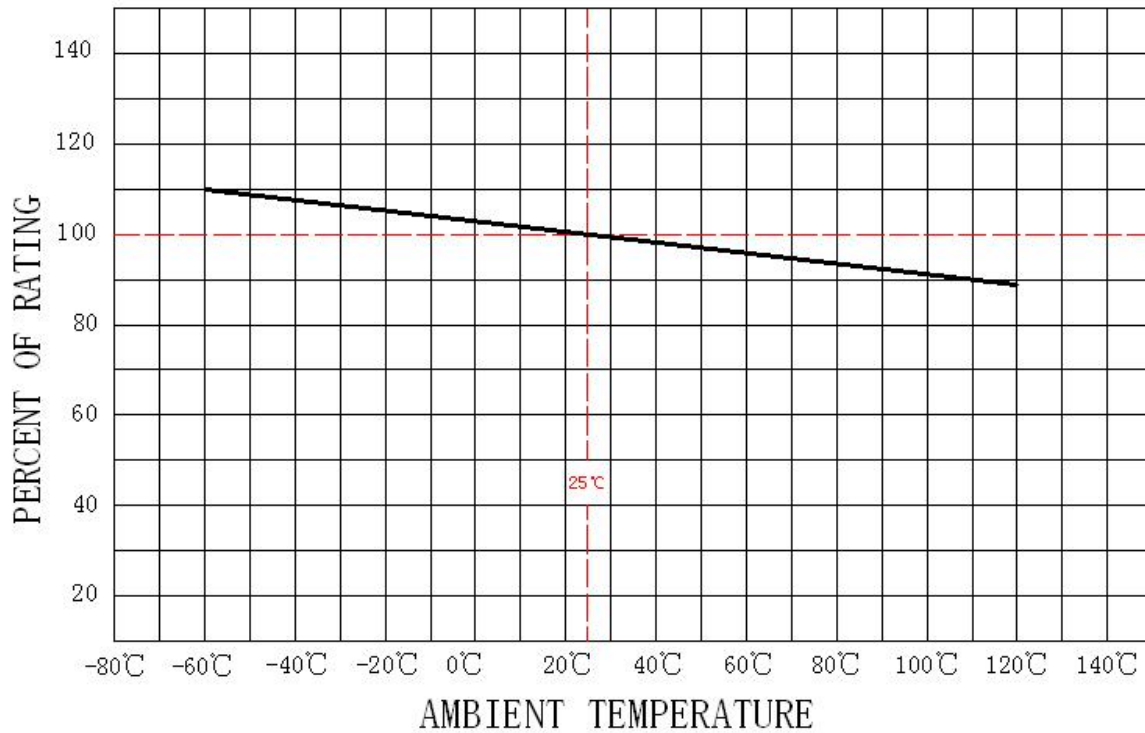

9-2 存儲條件 / Storage Conditions

在溫度+10°C~60°C、相對濕度 $\leq 75\%$ 的密閉條件下可存放 3 年。

Under airtight in temperature+10°C~60°C、relative humidity $\leq 75\%$ can store 3 years.

在溫度+10°C~60°C、相對濕度為 95%的非露天下最多可存放 30 天。

Without dew in temperature+10°C~60°C、relative humidity be 95% maximum value for 30days.

10. 安裝方式及條件 / INSTALLATION WAY AND PARAMETERS

10-1 建議如下圖安裝方式安裝，並滿足所要求的尺寸。

Propose that the following picture installation way is installed, and satisfied the required size.

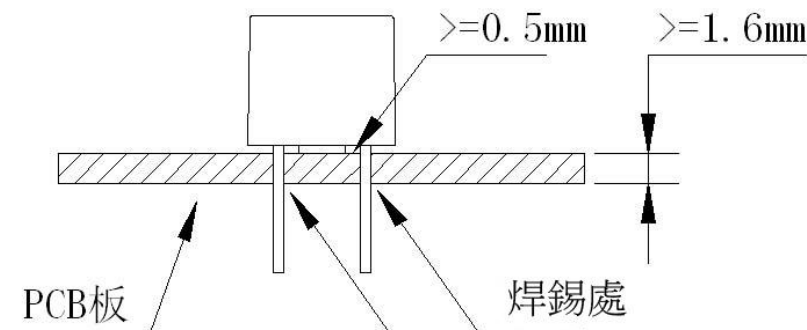

10-2 建議客戶焊接參數 / Recommended Customer Soldering Parameters

波峰焊參數 / Wave Parameters:

錫爐溫度 / Solder Pot Temperature:

260°C Max

焊接時間 / Solder Dwell Time:

2~5s

手工焊參數 / Hand-Solder Parameters:

烙鐵溫度 / Solder Iron Temperature:

350±5°C

焊接時間 / Heating Time:

1~2 s Max

11. 其他使用注意事項 / OTHER NOTICE IN USED

符合本公司可能的其他檔的要求。

It could be in conformance with another file, which made by our company.

12. 安全認證及編號 / STANDARDS AND APPROVALS

UL	E56092 (100mA~6.3A)
VDE	40018790 (100mA~4.0A)、40018787 (5.0A~6.3A)
SEMKO	1811349 (100mA~6.3A)
PSE	JET2179-31007-1002 (1.0A~5.0A)、JET2179-31007-1001 (6.3A)
CCC	2003010207068053 (100mA~6.3A)
KC	SU05015-5009 (100mA~250mA)、SU05015-5010 (315mA~400mA) SU05015-5011 (500mA~800mA)、SU05015-5012 (1.0A~2.5A) SU05015-5013 (3.15A~4.0A)、SU05015-5014 (5.0A~6.3A)

13.包裝 / PACKING

包裝數量 / Packing Quantity

A：編帶包裝每盒 1000 個保險絲
Taping package 1000 pcs per box

B：散裝每膠袋 1000 個保險絲
Bulk 1000 pcs/ poly bag
每盒 2 袋共 2000 個保險絲
2 poly bags / box, altogether 2000 pcs

14.其他 / OTHERS

14-1 如果在使用中有超出本規格書的要求，必須經由雙方協商確認。
In the event that an impropriety is found beyond this specification ,it shall be fixed by mutual agreement between the parties.

14-2 如果本規格書有不適當的情況，必須通過雙方協商並由本公司修改。
In the event that an impropriety is found in this specification , WALTER ELECTRONIC CO., LTD. shall amend it by mutual agreement between the parties.

版次	製作	確認	審核
第八版	饒紅	蔡明威	Eris Kuo



UL iQ for Fuses



Fuses

E56092

Guide Information

SUZHOU WALTER ELECTRONIC CO LTD

NO.99 Xinli Road, Fenhu Technic Development Zone, Wujiang Jiangsu 215211 CN

2000

Supplemental micro fuses: pigtail leads, filled-tube

<u>Size</u> mm(in)	<u>Amps</u> (A)	<u>Volts</u> (V)	<u>Interrupting</u> <u>Rating (A)</u>
8.3 x 7.8 (0.33 x 0.31)	0.1 - 6.3	250Vac	100
	0.1 - 6.3	300Vac	100

Report Date: 2001-12-20

Last Revised: 2019-07-22

© 2019 UL LLC



GUTACHTEN MIT FERTIGUNGSÜBERWACHUNG CERTIFICATE OF CONFORMITY WITH FACTORY SURVEILLANCE

Suzhou Walter Electronic
Co. Ltd.
Fenhu Technic Development Zone
215211 LUXU TOWN, WUJIANG CITY
Jiangsu
CHINA

ist berechtigt, für ihr Produkt /
is authorized to use for their product

Kleinstsicherungseinsatz
Sub-miniature fuse-link

die hier abgebildeten markenrechtlich geschützten Zeichen
für die ab Blatt 2 aufgeführten Typen zu benutzen /
the legally protected Marks as shown below for the types referred to on page 2 ff.



REG B937 oder/or



oder/or VDE-REG B937

REG B937

Geprüft und zertifiziert nach /
Tested and certified according to

DIN EN 60127-1 (VDE 0820-1):2015-12; EN 60127-1:2006+A1:2011+A2:2015
DIN EN 60127-3 (VDE 0820-3):2015-11; EN 60127-3:2015
IEC 60127-1:2006
IEC 60127-1:2006/AMD1:2011
IEC 60127-1:2006/AMD2:2015
IEC 60127-3:2015



Aktenzeichen: 5000410-1170-0023 / 253485

File ref.:

Ausweis-Nr. 40018787

Blatt 1

Certificate No.

Page

Weitere Bedingungen siehe Rückseite und Folgeblätter /
further conditions see overleaf and following pages

Offenbach, 2006-09-05

(letzte Änderung / updated 2018-11-29)

VDE Prüf- und Zertifizierungsinstitut GmbH
VDE Testing and Certification Institute
Zertifizierungsstelle / Certification

M. Tasotti

VDE Zertifikate sind nur gültig bei Veröffentlichung unter:
VDE certificates are valid only when published on:

<http://www.vde.com/zertifikat>
<http://www.vde.com/certificate>

Name und Sitz des Genehmigungs-Inhabers / Name and registered seat of the Certificate holder

Suzhou Walter Electronic Co. Ltd., Fenu Technic Development Zone, 215211 LUXU TOWN, WUJIANG CITY,
Jiangsu, CHINA

Aktenzeichen / File ref.

5000410-1170-0023 / 253485 / TL3 / EUL

letzte Änderung / updated

2018-11-29

Datum / Date

2006-09-05

Dieses Blatt gilt nur in Verbindung mit Blatt 1 des Gutachtens mit Fertigungsüberwachung Nr. 40018787.

This supplement is only valid in conjunction with page 1 of the Certificate of Conformity with factory surveillance No. 40018787.

Kleinleistungseinsatz Sub-miniature fuse-link

Typ(en) / Type(s)

2000

Bemessungsspannung Rated voltage	AC 250 V; AC 300 V
Bemessungsstrom Rated current	5 A; 6,3 A
Normblatt Standard sheet	4
Kennzeichnung der Charakteristik Characteristic symbol	T
Bemessungsausschaltvermögen Rated breaking capacity	100 A (AC 250 V; 5 A; 6,3 A) 50 A (AC 300 V; 5 A) 100 A (AC 300 V; 6,3 A)
Zeit/Strom-Charakteristik Time/current-characteristic	träge time-lag
Anmerkung Remark	Die Prüfspannung in Abschnitt 9.2 war DC 63 V. The test voltage in clause 9.2 was DC 63 V.

Dieser Zeichengenehmigungs-Ausweis bildet eine Grundlage für die EG-Konformitätserklärung und CE-Kennzeichnung durch den Hersteller oder dessen Bevollmächtigten und bescheinigt die Konformität mit den grundlegenden Schutzanforderungen der **EG-Niederspannungsrichtlinie 2014/35/EU**.

*This Marks Approval is a basis for the EC Declaration of Conformity and the CE Marking by the manufacturer or his agent and proves the conformity with the essential safety requirements of the **EC Low-Voltage Directive 2014/35/EU**.*

VDE Prüf- und Zertifizierungsinstitut GmbH
VDE Testing and Certification Institute
Fachgebiet TL3
Section TL3

VDE Prüf- und Zertifizierungsinstitut Gutachten mit Fertigungsüberwachung

Ausweis-Nr. / Beiblatt /
Certificate No. Supplement
40018787

Name und Sitz des Genehmigungs-Inhabers / *Name and registered seat of the Certificate holder*

Suzhou Walter Electronic Co. Ltd., Fenu Technic Development Zone, 215211 LUXU TOWN, WUJIANG CITY,
Jiangsu, CHINA

Aktenzeichen / *File ref.*

5000410-1170-0023 / 253485 / TL3 / EUL

letzte Änderung / *updated*

2018-11-29

Datum / *Date*

2006-09-05

Dieses Beiblatt ist Bestandteil des Gutachtens mit Fertigungsüberwachung Nr. 40018787.

This supplement is part of the Certificate of Conformity with factory surveillance No. 40018787.

Kleinstsicherungseinsatz

Sub-miniature fuse-link

Fertigungsstätte(n)

Place(s) of manufacture

Referenz/Reference

30006375

Dongguan Walter Electric Co., Ltd.

Yan Tian, Feng Gang Town

523702 DONGGUAN CITY

Guangdong

CHINA

Referenz/Reference

30011941

Suzhou Walter Electronic

Co. Ltd.

Fenu Technic Development Zone

215211 LUXU TOWN, WUJIANG CITY

Jiangsu

CHINA

VDE Prüf- und Zertifizierungsinstitut GmbH

VDE Testing and Certification Institute

Fachgebiet TL3

Section TL3



VDE Prüf- und Zertifizierungsinstitut Gutachten mit Fertigungsüberwachung

Ausweis-Nr. / Infoblatt /
Certificate No. / Info sheet
40018787

Name und Sitz des Genehmigungs-Inhabers / Name and registered seat of the Certificate holder

Suzhou Walter Electronic Co. Ltd., Fenu Technic Development Zone, 215211 LUXU TOWN, WUJIANG CITY,
Jiangsu, CHINA

Aktenzeichen / File ref.

5000410-1170-0023 / 253485 / TL3 / EUL

letzte Änderung / updated

2018-11-29

Datum / Date

2006-09-05

Dieses Blatt gilt nur in Verbindung mit Blatt 1 des Gutachtens mit Fertigungsüberwachung Nr. 40018787.

This supplement is only valid in conjunction with page 1 of the Certificate of Conformity with factory surveillance No. 40018787.

Genehmigung zum Benutzen des auf Seite 1 abgebildeten markenrechtlich geschützten Zeichens des VDE:

Grundlage für die Benutzung sind die Allgemeinen Geschäftsbedingungen (AGB) der VDE Prüf- und Zertifizierungsinstitut GmbH (www.vde.com\AGB-Institut). Das Recht zur Benutzung erstreckt sich nur auf die bezeichnete Firma mit den genannten Fertigungsstätten und die oben aufgeführten Produkte mit den zugeordneten Bezeichnungen. Die Fertigungsstätte muss so eingerichtet sein, dass eine gleichmäßige Herstellung der geprüften und zertifizierten Ausführung gewährleistet ist.

Die Genehmigung ist so lange gültig wie die VDE-Bestimmungen gelten, die der Zertifizierung zugrunde gelegen haben, sofern sie nicht auf Grund anderer Bedingungen aus der VDE Prüf- und Zertifizierungsordnung (PM102) zurückgezogen werden muss.

Der Gültigkeitszeitraum einer VDE-GS-Zeichengenehmigung kann auf Antrag verlängert werden. Bei gesetzlichen und / oder normativen Änderungen kann die VDE-GS-Zeichengenehmigung ihre Gültigkeit zu einem früheren als dem angegebenen Datum verlieren.

Produkte, die das Biozid Dimethylfumarat (DMF) enthalten, dürfen gemäß der Kommissionsentscheidung 2009/251/EG nicht mehr in den Verkehr gebracht oder auf dem Markt bereitgestellt werden.

Der VDE-Zeichengenehmigungsausweis wird ausschließlich auf der ersten Seite unterzeichnet.

Approval to use the legally protected Mark of the VDE as shown on the first page:

Basis for the use are the general terms and conditions of the VDE Testing and Certification Institute (www.vde.com\terms-institute). The right to use the mark is granted only to the mentioned company with the named places of manufacture and the listed products with the related type references. The place of manufacture shall be equipped in a way that a constant manufacturing of the certified construction is assured.

The approval is valid as long as the VDE specifications are in force, on which the certification is based on, unless it is withdrawn according to the VDE Testing and Certification Procedure (PM102E).

The validity period of a VDE-GS-Mark Approval may be prolonged on request. In case of changes in legal and / or normative requirements, the validity period of a VDE-GS-Mark Approval may be shortened.

Products containing the biocide dimethylfumarate (DMF) may not be marketed or made available on the EC market according to the Commission Decision 2009/251/EC.

The approval is solely signed on the first page.

ZEICHENGENEHMIGUNG MARKS APPROVAL

Suzhou Walter Electronic
Co. Ltd.
Fenhu Technic Development Zone
215211 LUXU TOWN, WUJIANG CITY
Jiangsu
CHINA

ist berechtigt, für ihr Produkt /
is authorized to use for their product

Kleinstsicherungseinsatz
Sub-miniature fuse-link

die hier abgebildeten markenrechtlich geschützten Zeichen
für die ab Blatt 2 aufgeführten Typen zu benutzen /
the legally protected Marks as shown below for the types referred to on page 2 ff.



Geprüft und zertifiziert nach /
Tested and certified according to

DIN EN 60127-1 (VDE 0820-1):2015-12; EN 60127-1:2006+A1:2011+A2:2015
DIN EN 60127-3 (VDE 0820-3):2015-11; EN 60127-3:2015
IEC 60127-1:2006
IEC 60127-1:2006/AMD1:2011
IEC 60127-1:2006/AMD2:2015
IEC 60127-3:2015



Aktenzeichen: 5000410-1170-0034 / 257554

File ref.:

Ausweis-Nr. 40018790

Blatt 1

Certificate No.

Page

Weitere Bedingungen siehe Rückseite und Folgeblätter /
further conditions see overleaf and following pages

Offenbach, 2006-09-05

(letzte Änderung / updated 2018-12-12)

VDE Prüf- und Zertifizierungsinstitut GmbH
VDE Testing and Certification Institute
Zertifizierungsstelle / Certification

R. Nickel

VDE Zertifikate sind nur gültig bei Veröffentlichung unter:
VDE certificates are valid only when published on:

<http://www.vde.com/zertifikat>
<http://www.vde.com/certificate>

Name und Sitz des Genehmigungs-Inhabers / *Name and registered seat of the Certificate holder*

Suzhou Walter Electronic Co. Ltd., Fenu Technic Development Zone, 215211 LUXU TOWN, WUJIANG CITY,
Jiangsu, CHINA

Aktenzeichen / *File ref.*

5000410-1170-0034 / 257554 / TL3 / EUL

letzte Änderung / *updated*

2018-12-12

Datum / *Date*

2006-09-05

Dieses Blatt gilt nur in Verbindung mit Blatt 1 des Zeichengenehmigungsausweises Nr. 40018790.

This supplement is only valid in conjunction with page 1 of the Certificate No. 40018790.

Kleinleistungseinsatz *Sub-miniature fuse-link*

Typ(en) / *Type(s)*

2000

Bemessungsspannung
Rated voltage

AC 250 V; AC 300 V

Bemessungsstrom
Rated current

100 mA; 125 mA; 160 mA; 200 mA;
250 mA; 315 mA; 400 mA; 500 mA;
630 mA; 800 mA; 1 A; 1,25 A; 1,6 A;
2 A; 2,5 A; 3,15 A; 4 A

Normblatt
Standard sheet

4

Kennzeichnung der Charakteristik
Characteristic symbol

T

Bemessungsausschaltvermögen
Rated breaking capacity

100 A (AC 250 V)
50 A (AC 300 V; 100 mA - 2,5 A)
100 A (AC 300 V; 3,15 A; 4 A)

Zeit/Strom-Charakteristik
Time/current-characteristic

träge
time-lag

Anmerkung
Remark

Die Prüfspannung in Abschnitt 9.2 war DC 63 V.
The test voltage in clause 9.2 was DC 63 V.

Dieser Zeichengenehmigungs-Ausweis bildet eine Grundlage für die EG-Konformitätserklärung und CE-Kennzeichnung durch den Hersteller oder dessen Bevollmächtigten und bescheinigt die Konformität mit den grundlegenden Schutzanforderungen der **EG-Niederspannungsrichtlinie 2014/35/EU**.

*This Marks Approval is a basis for the EC Declaration of Conformity and the CE Marking by the manufacturer or his agent and proves the conformity with the essential safety requirements of the **EC Low-Voltage Directive 2014/35/EU**.*

VDE Prüf- und Zertifizierungsinstitut GmbH
VDE Testing and Certification Institute
Fachgebiet TL3
Section TL3

VDE Prüf- und Zertifizierungsinstitut Zeichengenehmigung

Ausweis-Nr. / Beiblatt /
Certificate No. Supplement
40018790

Name und Sitz des Genehmigungs-Inhabers / *Name and registered seat of the Certificate holder*

Suzhou Walter Electronic Co. Ltd., Fenu Technic Development Zone, 215211 LUXU TOWN, WUJIANG CITY,
Jiangsu, CHINA

Aktenzeichen / *File ref.*

5000410-1170-0034 / 257554 / TL3 / EUL

letzte Änderung / *updated*

2018-12-12

Datum / *Date*

2006-09-05

Dieses Beiblatt ist Bestandteil des Zeichengenehmigungsausweises Nr. 40018790.

This supplement is part of the Certificate No. 40018790.

Kleinstsicherungseinsatz

Sub-miniature fuse-link

Fertigungsstätte(n)

Place(s) of manufacture

Referenz/*Reference*

30006375

Dongguan Walter Electric Co., Ltd.

Yan Tian, Feng Gang Town

523702 DONGGUAN CITY

Guangdong

CHINA

Referenz/*Reference*

30011941

Suzhou Walter Electronic

Co. Ltd.

Fenu Technic Development Zone

215211 LUXU TOWN, WUJIANG CITY

Jiangsu

CHINA

VDE Prüf- und Zertifizierungsinstitut GmbH

VDE Testing and Certification Institute

Fachgebiet TL3

Section TL3



Name und Sitz des Genehmigungs-Inhabers / *Name and registered seat of the Certificate holder*

Suzhou Walter Electronic Co. Ltd., Fenuh Technic Development Zone, 215211 LUXU TOWN, WUJIANG CITY,
Jiangsu, CHINA

Aktenzeichen / *File ref.*

5000410-1170-0034 / 257554 / TL3 / EUL

letzte Änderung / *updated*

2018-12-12

Datum / *Date*

2006-09-05

Dieses Blatt gilt nur in Verbindung mit Blatt 1 des Zeichengenehmigungsausweises Nr. 40018790.

This supplement is only valid in conjunction with page 1 of the Certificate No. 40018790.

Genehmigung zum Benutzen des auf Seite 1 abgebildeten markenrechtlich geschützten Zeichens des VDE:

Grundlage für die Benutzung sind die Allgemeinen Geschäftsbedingungen (AGB) der VDE Prüf- und Zertifizierungsinstitut GmbH (www.vde.com\AGB-Institut). Das Recht zur Benutzung erstreckt sich nur auf die bezeichnete Firma mit den genannten Fertigungsstätten und die oben aufgeführten Produkte mit den zugeordneten Bezeichnungen. Die Fertigungsstätte muss so eingerichtet sein, dass eine gleichmäßige Herstellung der geprüften und zertifizierten Ausführung gewährleistet ist.

Die Genehmigung ist so lange gültig wie die VDE-Bestimmungen gelten, die der Zertifizierung zugrunde gelegen haben, sofern sie nicht auf Grund anderer Bedingungen aus der VDE Prüf- und Zertifizierungsordnung (PM102) zurückgezogen werden muss.

Der Gültigkeitszeitraum einer VDE-GS-Zeichengenehmigung kann auf Antrag verlängert werden. Bei gesetzlichen und / oder normativen Änderungen kann die VDE-GS-Zeichengenehmigung ihre Gültigkeit zu einem früheren als dem angegebenen Datum verlieren.

Produkte, die das Biozid Dimethylfumarat (DMF) enthalten, dürfen gemäß der Kommissionsentscheidung 2009/251/EG nicht mehr in den Verkehr gebracht oder auf dem Markt bereitgestellt werden.

Der VDE-Zeichengenehmigungsausweis wird ausschließlich auf der ersten Seite unterzeichnet.

Approval to use the legally protected Mark of the VDE as shown on the first page:

Basis for the use are the general terms and conditions of the VDE Testing and Certification Institute (www.vde.com\terms-institute). The right to use the mark is granted only to the mentioned company with the named places of manufacture and the listed products with the related type references. The place of manufacture shall be equipped in a way that a constant manufacturing of the certified construction is assured.

The approval is valid as long as the VDE specifications are in force, on which the certification is based on, unless it is withdrawn according to the VDE Testing and Certification Procedure (PM102E).

The validity period of a VDE-GS-Mark Approval may be prolonged on request. In case of changes in legal and / or normative requirements, the validity period of a VDE-GS-Mark Approval may be shortened.

Products containing the biocide dimethylfumarate (DMF) may not be marketed or made available on the EC market according to the Commission Decision 2009/251/EC.

The approval is solely signed on the first page.

Certificate



for European Product Safety

Reference No. 1811349

Sub-miniature fuse-link

<i>Type designation</i>	2000
<i>Certificate holder</i>	Suzhou Walter Electronic Co., Ltd. Fenhu Technic Development Zone Wujiang, Jiangsu CHINA
<i>The product complies with the standard(s)</i>	EN 60127-3:2015 EN 60127-1:2006+A1+A2
<i>Date of expiry</i>	19 January 2022
<i>EU Directive information</i>	According to the principle of presumption of conformity, this certificate constitutes support for an EC Declaration of Conformity and CE marking according to the Low Voltage Directive 2014/35/EU.

Additional information in Appendix.

<i>Certification Body</i>	Intertek Semko AB, Product Certification	<i>Place</i>	Kista - Stockholm
<i>Signed</i>	 _____ Paul Klemets	<i>Date</i>	17 August 2018 Page 1 of 3



This certificate is issued in accordance with the terms and conditions set out in the Appendix.



Intertek
Appendix

Reference No. 1811349

Technical data

Type designation		2000									
Rated voltage (V)		250V AC									
		300V AC									
Rated current	(mA)	100	125	160	200	250	315	400	500	630	800
	(A)	1	1,25	1,6	2	2,5	3,15	4	5	6,3	
Standard sheet		4									
Trademark			or								
Product information		Time-lag, low-breaking capacity. Rated breaking capacity: 100 A at 250V AC 50 A at 300V AC									

This Certificate is for the exclusive use of Intertek's Client and is provided pursuant to the Certification agreement between Intertek and its Client. Intertek's responsibility and liability are limited to the terms and conditions of the agreement. Intertek assumes no liability to any party, other than to the Client in accordance with the agreement, for any loss, expense or damage occasioned by the use of this certificate. Only the Client is authorized to permit copying or distribution of this certificate and then only in its entirety. Use of Intertek's Certification mark is restricted to the conditions laid out in the agreement. Any further use of the Intertek name for the sale or advertisement of the tested material, product or service must first be approved in writing by Intertek. Initial Factory Assessments and Follow up Services are for the purpose of assuring appropriate usage of the Certification mark in accordance with the agreement, they are not for the purposes of production quality control and do not relieve the Client of their obligations in this respect.

AMP

**Intertek
Appendix***Reference No. 1811349*

Manufacturing site(s) Dongguan Walter Electric Co., Ltd
Yan Tian, Feng Gang Town
523702 DongGuan City
Guangdong
CHINA

Suzhou Walter Electronic Co., Ltd.
Fenhu Technic Development Zone
Wujiang, Jiangsu
CHINA

According to the principle of presumption of conformity, this certificate, which includes production control, constitutes support for an EC Declaration of Conformity and CE marking according to the Low Voltage Directive 2014/35/EU.

This presumption can expire before end of validity of this certificate due to new issued Standard or Amendment and changes within the EU legislation.

This certificate replaces previously issued ref. No. 1614647 dated 10 November 2016.
A new certificate has been issued on account of change of certificate holder.

Certification Body Intertek Semko AB, Product Certification *Place* Kista - Stockholm

Signed

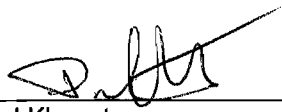

Paul Klemets

Date 17 August 2018

This Certificate is for the exclusive use of Intertek's Client and is provided pursuant to the Certification agreement between Intertek and its Client. Intertek's responsibility and liability are limited to the terms and conditions of the agreement. Intertek assumes no liability to any party, other than to the Client in accordance with the agreement, for any loss, expense or damage occasioned by the use of this certificate. Only the Client is authorized to permit copying or distribution of this certificate and then only in its entirety. Use of Intertek's Certification mark is restricted to the conditions laid out in the agreement. Any further use of the Intertek name for the sale or advertisement of the tested material, product or service must first be approved in writing by Intertek. Initial Factory Assessments and Follow up Services are for the purpose of assuring appropriate usage of the Certification mark in accordance with the agreement, they are not for the purposes of production quality control and do not relieve the Client of their obligations in this respect.



中国国家强制性产品认证证书

证书编号：2003010207068053

委托人名称、地址

苏州华德电子有限公司
江苏省吴江市汾湖经济技术开发区(芦墟)

生产者(制造商)名称、地址

苏州华德电子有限公司
江苏省吴江市汾湖经济技术开发区(芦墟)

生产企业名称、地址

苏州华德电子有限公司
江苏省吴江汾湖经济开发区新黎路99号

产品名称和系列、规格、型号

超小型熔断体

2000 T100mA250V、2000 T125mA250V、2000 T160mA250V、2000 T200mA250V、2000 T250mA250V、2000 T315mA250V、2000 T400mA250V、2000 T500mA250V、2000 T630mA250V、2000 T800mA250V、2000 T1A250V、2000 T1.25A250V、2000 T1.6A250V、2000 T2A250V、2000 T2.5A250V、2000 T3.15A250V、2000 T4A250V、2000 T5A250V、2000 T6.3A250V

产品标准和技术要求

GB/T9364.3-2018;GB/T9364.1-2015

上述产品符合强制性产品认证实施规则 CNCA-C02-01:2014 的要求，特发此证。

发证日期：2019年07月08日 有效期至：2024年07月08日

证书有效期内本证书的有效性依据发证机构的定期监督获得保持。

本证书为变更证书，证书首次颁发日期：2003年07月28日

本证书的相关信息可通过国家认监委网站 www.cnca.gov.cn 查询



主任：陆梅



中国质量认证中心



CERTIFICATE FOR CHINA COMPULSORY PRODUCT CERTIFICATION

CERTIFICATE NO.: 2003010207068053

NAME AND ADDRESS OF THE APPLICANT

Suzhou Walter Electronic Co., Ltd.
Fenhu Technic Development Zone, Luxu, Wujiang City, Jiangsu

NAME AND ADDRESS OF THE MANUFACTURER

Suzhou Walter Electronic Co., Ltd.
Fenhu Technic Development Zone, Luxu, Wujiang City, Jiangsu

NAME AND ADDRESS OF THE FACTORY

Suzhou Walter Electronic Co., Ltd.
South of Xinli Road, Fenhu Technic Development Zone, Luxu, Wujiang City, Jiangsu

PRODUCT NAME, MODEL AND SPECIFICATION

Sub-miniature Fuse-link

2000 T100mA250V、2000 T125mA250V、2000 T160mA250V、2000 T200mA250V、2000 T250mA250V、2000 T315mA250V、2000 T400mA250V、2000 T500mA250V、2000 T630mA250V、2000 T800mA250V、2000 T1A250V、2000 T1.25A250V、2000 T1.6A250V、2000 T2A250V、2000 T2.5A250V、2000 T3.15A250V、2000 T4A250V、2000 T5A250V、2000 T6.3A250V

THE STANDARDS AND TECHNICAL REQUIREMENTS FOR THE PRODUCTS

GB/T9364.3-2018;GB/T9364.1-2015

This is to certify that the above mentioned product(s) complies with the requirements of implementation rules for compulsory certification(REFNO.CNCA-C02-01:2014).

Valid from: Jul.08,2019

Valid until: Jul.08,2024

The validity of the certificate is subject to positive result of the regular follow up inspection by issuing certification body until the expiry date.

Date of original issued: Jul.28,2003

The certificate information is available through CNCA's website: www.cnca.gov.cn



President:

Lu Mei



CHINA QUALITY CERTIFICATION CENTRE

適合同等証明書

Statement of Conformity Assessment

電気用品安全法第8条第1項に規定する技術基準及び同法第9条第2項の経済産業省令で定める基準（法第9条第1項第2号に係る検査に係るものに限る）に適合していることを証明します

I hereby certify that the product mentioned below complies with the technical requirements stipulated in Paragraph 1 of Article 8 of Electrical Appliances and Materials Safety Act (here under referred to as the Act) and the requirements defined by the ordinance of the Ministry of Economy, Trade and Industry based on Paragraph 2 of Article 9 of the Act (limited to Item 2 of Paragraph 1 of Article 9 for Inspection of the Act).

1. 証明書番号: JET 2179-31007-1002
Statement Number
2. 交付年月日: 2019年9月29日
Effective Date September 29, 2019
3. 有効年月日: 2026年9月28日
Date of Validity September 28, 2026
4. 申込者名 (Applicant)
住所: FENHU TECHNIC DEVELOPMENT ZONE WUJIANG, JIANGSU PROVINCE, CHINA
Address

氏名又は名称: SUZHOU WALTER ELECTRONIC CO., LTD.
Name

5. 特定電気用品名: その他の包装ヒューズ
Name of Product Other enclosed fuses
6. 型式の区分: 別紙のとおり
Type Classification See attached "Type Classification"
7. 製造工場名 (Manufacturer)
住所: FENHU TECHNIC DEVELOPMENT ZONE WUJIANG, JIANGSU PROVINCE, CHINA
Address

氏名又は名称: SUZHOU WALTER ELECTRONIC CO., LTD.
Name

8. 適用試験規格: 電気用品の技術上の基準を定める省令の解釈
Applied Standard for Testing Description of the technical requirements by the METI Ordinance
別表第三2

Appendix 3 Section 2

9. 適合性検査の方法: (Testing Method for Conformity Assessment)
 - 1) 試験用の特定電気用品については、電気用品の技術上の基準を定める省令の解釈に定める方法
With respect to testing for Category A products, the testing method is based on the technical requirements of the description of Electrical Appliances and Materials stipulated in the METI Ordinance.
 - 2) 当該特定電気用品に係る届出事業者又は事業場における検査設備については、電気用品安全法施行規則別表第四の検査設備の欄に掲げる検査設備ごとにそれぞれ同表の技術上の基準の欄に掲げる方法
With respect to inspection facilities required for Category A products at the factory, Testing Method described in the column of the technical requirements for each inspection facilities in the column of inspection facilities is shown in the Appendix 4 of Enforcement Regulations of the Act.

10. 注意事項

- 1) この適合同等証明書は、提出された試験用の電気用品に関して評価を行った上で交付したものであり、同一の型式の区分にある電気用品について電気用品安全法第8条1項に規定する技術基準適合確認の義務を履行したことを示すものではありません。

This Statement of Conformity Assessment, which is issued on the evaluation of the submitted test-use Electrical Appliances and Materials, does not signify that the Obligation to Comply with Requirements, which is prescribed at Paragraph 1 of Article 8 of the Act, is fulfilled on Electrical Appliances and Materials in the same Type Classification.

- 2) この適合同等証明書は、別紙に記載されている型式の区分の範囲内及び区分の組み合わせについてのみ有効です。

This Statement of Conformity Assessment is valid only for Electrical Appliances and Materials within the Type Classifications and their combination as stated in the attached "Type Classification".

一般財団法人 電気安全環境研究所
Japan Electrical Safety & Environment technology Laboratories (JET)

理事長 薦田 康久
President Yasuhisa Komoda

東京都渋谷区代々木5-14-12
(5-14-12, Yoyogi, Shibuya-ku, Tokyo, Japan)

証明書番号 : J E T 2 1 7 9 - 3 1 0 0 7 - 1 0 0 2

適合同等証明書別紙

Statement of Conformity Assessment

型式の区分

Type Classification

要素 Factor	区分 Classification
定格電圧 Rated voltage	(2) 125Vを超えるもの Exceeding 125V
定格電流（定格電流表示のあるものの場合に限る。） Rated current (limited to those with rated current markings)	(1) 5 A以下のもの 5A or less
適用電動機の定格容量（定格電流表示のないものの場合に限る。） Rated capacity of applicable motor (limited to those without rated current markings)	—
可溶体の主材料 Fuse element materials	(5) 銅のもの Copper
可溶体の数 Number of fuse elements	(1) 1のもの One
再使用（管形ヒューズを除く。） Reusability (excluding cartridge fuses)	(2) できないもの Not reusable
内部充てん物 Filler materials	(1) あるもの With filler materials
筒（内筒を除く。）の材料 Outer cartridge materials	(7) その他のもの Others
端子 Terminals	(5) その他のもの Others
排気孔 Exhausting opening	(2) ないもの Without exhausting opening
溶断の表示 Blowout fuse indicator	(2) ないもの Without blowout fuse indicator
用途 Application	(2) 電子機器用のもの For use in electric appliances
定格遮断電流 Rated breaking capacity	(1) 100 A以下のもの 100A or less

証明書番号：JET2179-31007-1002

適合同等証明書

Statement of Conformity Assessment

電気用品安全法第8条第1項に規定する技術基準及び同法第9条第2項の経済産業省令で定める基準（法第9条第1項第2号に係る検査に係るものに限る）に適合していることを証明します

I hereby certify that the product mentioned below complies with the technical requirements stipulated in Paragraph 1 of Article 8 of Electrical Appliances and Materials Safety Act (here under referred to as the Act) and the requirements defined by the ordinance of the Ministry of Economy, Trade and Industry based on Paragraph 2 of Article 9 of the Act (limited to Item 2 of Paragraph 1 of Article 9 for Inspection of the Act).

1. 証明書番号: JET 2179-31007-1001
Statement Number
2. 交付年月日: 2019年9月29日
Effective Date September 29, 2019
3. 有効年月日: 2026年9月28日
Date of Validity September 28, 2026
4. 申込者名 (Applicant)
住 所: FENHU TECHNIC DEVELOPMENT ZONE WUJIANG, JIANGSU PROVINCE, CHINA
Address

氏名又は名称: SUZHOU WALTER ELECTRONIC CO., LTD.
Name

5. 特定電気用品名: その他の包装ヒューズ
Name of Product Other enclosed fuses
6. 型式の区分: 別紙のとおり
Type Classification See attached "Type Classification"
7. 製造工場名 (Manufacturer)
住 所: FENHU TECHNIC DEVELOPMENT ZONE WUJIANG, JIANGSU PROVINCE, CHINA
Address

氏名又は名称: SUZHOU WALTER ELECTRONIC CO., LTD.
Name

8. 適用試験規格: 電気用品の技術上の基準を定める省令の解釈
Applied Standard for Testing Description of the technical requirements by the METI Ordinance
別表第三 2

Appendix 3 Section 2

9. 適合性検査の方法: (Testing Method for Conformity Assessment)
 - 1) 試験用の特定電気用品については、電気用品の技術上の基準を定める省令の解釈に定める方法
With respect to testing for Category A products, the testing method is based on the technical requirements of the description of Electrical Appliances and Materials stipulated in the METI Ordinance.
 - 2) 当該特定電気用品に係る届出事業者又は事業場における検査設備については、電気用品安全法施行規則別表第四の検査設備の欄に掲げる検査設備ごとにそれぞれ同表の技術上の基準の欄に掲げる方法
With respect to inspection facilities required for Category A products at the factory, Testing Method described in the column of the technical requirements for each inspection facilities in the column of inspection facilities is shown in the Appendix 4 of Enforcement Regulations of the Act.

10. 注意事項

- 1) この適合同等証明書は、提出された試験用の電気用品に関して評価を行った上で交付したものであり、同一の型式の区分にある電気用品について電気用品安全法第8条1項に規定する技術基準適合確認の義務を履行したことを示すものではありません。

This Statement of Conformity Assessment, which is issued on the evaluation of the submitted test-use Electrical Appliances and Materials, does not signify that the Obligation to Comply with Requirements, which is prescribed at Paragraph 1 of Article 8 of the Act, is fulfilled on Electrical Appliances and Materials in the same Type Classification.

- 2) この適合同等証明書は、別紙に記載されている型式の区分の範囲内及び区分の組み合わせについてのみ有効です。

This Statement of Conformity Assessment is valid only for Electrical Appliances and Materials within the Type Classifications and their combination as stated in the attached "Type Classification".

一般財団法人 電気安全環境研究所
Japan Electrical Safety & Environment technology Laboratories (JET)

理事長 薦田 康久
President Yasuhisa Komoda

東京都渋谷区代々木5-14-12
(5-14-12, Yoyogi, Shibuya-ku, Tokyo, Japan)

証明書番号 : J E T 2 1 7 9 - 3 1 0 0 7 - 1 0 0 1

適合同等証明書別紙

Statement of Conformity Assessment

型式の区分

Type Classification

要素 Factor	区分 Classification
定格電圧 Rated voltage	(2) 125Vを超えるもの Exceeding 125V
定格電流（定格電流表示のあるものの場合に限る。） Rated current (limited to those with rated current markings)	(2) 5 Aを超え15 A以下のもの Exceeding 5A, and less than or equal to 15A
適用電動機の定格容量（定格電流表示のないものの場合に限る。） Rated capacity of applicable motor (limited to those without rated current markings)	—
可溶体の主材料 Fuse element materials	(5) 銅のもの Copper
可溶体の数 Number of fuse elements	(1) 1のもの One
再使用（管形ヒューズを除く。） Reusability (excluding cartridge fuses)	(2) できないもの Not reusable
内部充てん物 Filler materials	(1) あるもの With filler materials
筒（内筒を除く。）の材料 Outer cartridge materials	(7) その他のもの Others
端子 Terminals	(5) その他のもの Others
排気孔 Exhausting opening	(2) ないもの Without exhausting opening
溶断の表示 Blowout fuse indicator	(2) ないもの Without blowout fuse indicator
用途 Application	(2) 電子機器用のもの For use in electric appliances
定格遮断電流 Rated breaking capacity	(1) 100 A以下のもの 100A or less

証明書番号：JET 2179 - 31007 - 1001

접수번호 : 05-1920-5638
(Order No.)



전기용품안전인증서

Electrical Appliances Safety Certificate

안전인증번호 : SU05015-5009
(Certificate No.)

제조업자명 : Suzhou Walter Electronic Co., Ltd.
(Manufacturer)

대표자명 : -
(President)

제조공장의 소재지 : Fânhu, Technic Development Zone, Luxu Wu Jiang, Jiangsu, P.R. China
(Factory Address)

제품명 : 소형퓨즈 (Sub-miniature fuse-link)
(Product)

기본모델명 : 2000 250mA
(Basic Model)

정격 : AC250V, 250mA
(Rating)

파생모델명 : See the attachment 2
(Series Model)

적용기준 : K60127-1, K60127-3
(Standard)

「전기용품안전 관리법 시행령」 제4조제3항의 규정에 의하여 위의 전기용품에 대하여 안전인증서를 교부합니다.

We Issue Electrical Appliances Safety Certification as above product by Article 4 Section 3 of the Electrical Appliances Safety Control Law Operation Rule.

2006년 03월 03일
year month day



산업기술시험원
KOREA TESTING LABORATORY



- 첨부 : 1. 안전관리부품 및 재질목록 (List of Critical Components)
(Annex) 2. 기본모델·파생모델의 내용 (General Descriptions of Certified Products)
3. 전기용품안전인증의 변경 현황 (Status of Certificate Revisions)

첨부 2 : 기본모델, 파생모델의 내용
General descriptions of Certified Products

파생모델명 Derivative model name	기본모델과의 차이점 Differences between the basic and derivative model(s)
2000 100mA	Rated current is different.
2000 125mA	Rated current is different.
2000 160mA	Rated current is different.
2000 200mA	Rated current is different.
2010 100mA	Rated current and appearance are different.
2010 125mA	Rated current and appearance are different.
2010 160mA	Rated current and appearance are different.
2010 200mA	Rated current and appearance are different.
2010 250mA	Rated current and appearance are different.
시험조건 및 시험결과 Remarks & Test conditions	
1. Test Report Ref. No. : 05-1920-5638 (2006. 02. 28) 2. Product Description - Ratings : 250V~, 250mA - Model : 2000 250mA - Sub-miniature Fuse links.	
<input type="checkbox"/> 본 제품의 시험내용에 관하여 문의하실 사항이 있으시면 아래 연락처로 문의하시기 바랍니다. 시험담당자 : 전기전자본부, 부품평가팀, 정문석 / (02)8601-406 <input type="checkbox"/> If you have any question on product testing, please contact the person below : Job holder : Electro-Technical Center, Components Assessment Team, M.S. Jung /+82 2 8601-406	

FP511-09-00

첨부 3 : 전기용품안전인증의 변경 현황
Status of Certificate Revisions

변경발급 내용 Contents of Certificate Revisions
Not Applicable

FP511-11-00

접수번호 : 05-1920-5639
(Order No.)



전기용품안전인증서

Electrical Appliances Safety Certificate

안전인증번호 : SU05015-5010
(Certificate No.)

제조업자명 : Suzhou Walter Electronic Co., Ltd.
(Manufacturer)

대표자명 :
(President)

제조공장의 소재지 : Fénghu, Technic Development Zone, Luxu Wu Jiang, Jiangsu,
(Factory Address) P.R. China

제품명 : 소형퓨즈 (Sub-miniature fuse-link)
(Product)

기본모델명 : 2000 400mA
(Basic Model)

정격 : AC250V, 400mA
(Rating)

파생모델명 : 2000 315mA, 2010 315mA, 2010 400mA
(Series Model)

적용기준 : K60127-1, K60127-3
(Standard)

「전기용품안전 관리법 시행령」 제4조제3항의 규정에 의하여 위의 전기용품에 대하여 안전인증서를 교부합니다.

We issue Electrical Appliances Safety Certification as above product by Article 4 Section 3 of the Electrical Appliances Safety Control Law Operation Rule.

2006년 03월 03일
year month day



산업기술시험원

KOREA TESTING LABORATORY



- 첨부 : 1. 안전관리부품 및 재질목록 (List of Critical Components)
(Annex) 2. 기본모델·파생모델의 내용 (General Descriptions of Certified Products)
3. 전기용품안전인증의 변경 현황 (Status of Certificate Revisions)

첨부 2 : 기본모델 · 파생모델의 내용
General descriptions of Certified Products

파생모델명 Derivative model(s)	기본모델과의 차이점 Differences between the basic and derivative model(s)
2000 315mA	Rated current is different.
2010 315mA	Rated current and appearance are different.
2010 400mA	Rated current and appearance are different.
제품특기사항 및 시험조건 Remarks & Test conditions	
1. Test Report Ref. No. : 05-1920-5639 (2006. 02. 28) 2. Product Description <ul style="list-style-type: none"> - Ratings : 250V~, 400mA - Model : 2000 400mA - Sub-miniature Fuse links. 	
□ 본 제품의 시험내용에 관하여 문의하실 사항이 있으시면 아래 연락처로 문의하시기 바랍니다. 시험담당자 : 전기전자본부, 부품평가팀, 정문석 / (02)8601-406 □ If you have any question on product testing, please contact the person below : Job holder : Electro-Technical Center, Components Assessment Team, M.S. Jung /+82 2 8601-406	

FP511-09-00

첨부 3 : 전기용품안전인증의 변경 현황
Status of Certificate Revisions

변경발급 내용 Contents of Certificate Revisions
Not Applicable

FP511-11-00

접수번호 : 05-1920-5640
(Order No.)



전기용품안전인증서

Electrical Appliances Safety Certificate

안전인증번호 : SU05015-5011
(Certificate No.)

제조업자명 : Suzhou Walter Electronic Co., Ltd.
(Manufacturer)

대표자명 : -
(President)

제조공장의 소재지 : Fénhu, Technic Development Zone, Luxu Wu Jiang, Jiangsu,
(Factory Address) P.R. China

제품명 : 소형퓨즈 (Sub-miniature fuse-link)
(Product)

기본모델명 : 2000 800mA
(Basic Model)

정격 : AC250V, 800mA
(Rating)

파생모델명 : See the attachment 2
(Series Model)

적용기준 : K60127-1, K60127-3
(Standard)

「전기용품안전 관리법 시행령」 제4조제3항의 규정에 의하여 위의 전기용품에 대하여 안전인증서를 교부합니다.

We Issue Electrical Appliances Safety Certification as above product by Article 4 Section 3 of the Electrical Appliances Safety Control Law Operation Rule.

2006년 03월 03일
year month day



산업기술시험원
KOREA TESTING LABORATORY

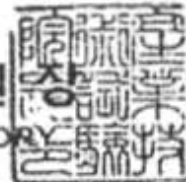

첨부 : 1. 안전관리부품 및 재질목록 (List of Critical Components)
(Annex) 2. 기본모델 - 파생모델의 내용 (General Descriptions of Certified Products)
3. 전기용품안전인증의 변경 현황 (Status of Certificate Revisions)

첨부 2 : 기본모델 - 파생모델의 내용
General descriptions of Certified Products

파생모델명 Derivative model	기본모델과의 차이점 Differences between the basic and derivative mode(s)
2000 500mA	Rated current is different.
2000 630mA	Rated current is different.
2010 500mA	Rated current and appearance are different.
2010 630mA	Rated current and appearance are different.
2010 800mA	Rated current and appearance are different.
시험특이사항 및 시험조건 Remarks & Test conditions	
1. Test Report Ref. No. : 05-1920-5640 (2006. 02. 28) 2. Product Description - Ratings : 250V~, 800mA - Model : 2000 800mA - Sub-miniature Fuse links.	
□ 본 제품의 시험내용에 관하여 문의하실 사항이 있으시면 아래 연락처로 문의하시기 바랍니다. 시험담당자 : 전기전자본부, 부품평가팀, 정문식 / (02)8601-406 □ If you have any question on product testing, please contact the person below : Job holder : Electro-Technical Center, Components Assessment Team, M.S. Jung / +82 2 8601-406	

FP511-09-00

첨부 3 : 전기용품안전인증의 변경 현황
Status of Certificate Revisions

변경발급 내용 Contents of Certificate Revisions
Not Applicable

FP511-11-00

접수번호 : 05-1920-5641
(Order No.)



전기용품안전인증서

Electrical Appliances Safety Certificate

안전인증번호 : SU05015-5012
(Certificate No.)

제조업자명 : Suzhou Walter Electronic Co., Ltd.
(Manufacturer)

대표자명 :
(President)

제조공장의 소재지 : Fénhu, Technic Development Zone, Luxu Wu Jiang, Jiangsu,
(Factory Address) P.R. China

제품명 : 소형퓨즈 (Sub-miniature fuse-link)
(Product)

기본모델명 : 2000 2.5A
(Basic Model)

정격 : AC250V, 2.5A
(Rating)

파생모델명 : See the attachment 2
(Series Model)

적용기준 : K60127-1, K60127-3
(Standard)

「전기용품안전 관리법 시행령」 제4조제3항의 규정에 의하여 위의 전기용품에 대하여 안전인증서를 교부합니다.

We issue Electrical Appliances Safety Certification as above product by Article 4 Section 3 of the Electrical Appliances Safety Control Law Operation Rule.

2006년 03월 06일
year month day



산업기술시험원
KOREA TESTING LABORATORY



- 첨부 : 1. 안전관리부품 및 재질목록 (List of Critical Components)
(Annex) 2. 기본모델·파생모델의 내용 (General Descriptions of Certified Products)
3. 전기용품안전인증의 변경 현황 (Status of Certificate Revisions)

첨부 2: 기본모델 · 파생모델의 내용
General descriptions of Certified Products

파생모델명 Derivative model(s)	기본모델과의 차이점 Differences between the basic and derivative model(s)
2000 1A	Rated current is different.
2000 1.25A	Rated current is different.
2000 1.6A	Rated current is different.
2000 2A	Rated current is different.
2010 1A	Rated current and appearance are different.
2010 1.25A	Rated current and appearance are different.
2010 1.6A	Rated current and appearance are different.
2010 2A	Rated current and appearance are different.
2010 2.5A	Rated current and appearance are different.
제품특기사항(필: 시험조건) Remarks & Test conditions	
1. Test Report Ref. No. : 05-1920-5641 (2006. 02. 28) 2. Product Description - Ratings : 250V~, 2.5A - Model : 2000 2.5A - Sub-miniature Fuse links.	
☞ 본 제품의 시험내용에 관하여 문의하실 사항이 있으시면 아래 연락처로 문의하시기 바랍니다. 시험담당자 : 전기전자본부, 부품평가팀, 정문식 / (02)8601-406 ☞ If you have any question on product testing, please contact the person below : Job holder : Electro-Technical Center, Components Assessment Team, M.S. Jung /+82 2 8601-406	

FP511-09-00

첨부 3: 전기용품안전인증의 변경 현황
Status of Certificate Revisions

변경발급 내용 Contents of Certificate Revisions
Not Applicable

FP511-11-00

접수번호 : 05-1920-5642
(Order No.)



전기용품안전인증서

Electrical Appliances Safety Certificate

안전인증번호 : SU05015-5013
(Certificate No.)

제조업자명 : Suzhou Walter Electronic Co., Ltd.
(Manufacturer)

대표자명 : -
(President)

제조공장의 소재지 : Fénghu, Technic Development Zone, Luxu Wu Jiang, Jiangsu, P.R. China
(Factory Address)

제품명 : 소형퓨즈 (Sub-miniature fuse-link)
(Product)

기본모델명 : 2000 4A
(Basic Model)

정격 : AC250V, 4A
(Rating)

파생모델명 : 2000 3.15A, 2010 3.15A, 2010 4A
(Series Model)

적용기준 : K60127-1, K60127-3
(Standard)

「전기용품안전 관리법 시행령」 제4조제3항의 규정에 의하여 위의 전기용품에 대하여 안전인증서를 교부합니다.

We issue Electrical Appliances Safety Certification as above product by Article 4 Section 3 of the Electrical Appliances Safety Control Law Operation Rule.

2006년 03월 06일
year month day



산업기술시험원
KOREA TESTING LABORATORY



- 첨부 : 1. 안전관리부품 및 재질목록 (List of Critical Components)
(Annex) 2. 기본모델·파생모델의 내용 (General Descriptions of Certified Products)
3. 전기용품안전인증의 변경 현황 (Status of Certificate Revisions)

첨부 2 : 기본모델 · 파생모델의 내용
General descriptions of Certified Products

파생모델명 Derivative model	기본모델과의 차이점 Differences between the basic and derivative model(s)
2000 3.15A	Rated current is different.
2010 3.15A	Rated current and appearance are different.
2010 4A	Rated current and appearance are different.
제품특기사항 및 시험조건 Remarks & Test conditions	
1. Test Report Ref. No. : 05-1920-5642 (2006. 02. 28) 2. Product Description <ul style="list-style-type: none"> - Ratings : 250V~, 4A - Model : 2000 4A - Sub-miniature Fuse links. 	
<input type="checkbox"/> 본 제품의 시험내용에 관하여 문의하실 사항이 있으시면 아래 연락처로 문의하시기 바랍니다. 시험담당자 : 전기전자본부, 부품평가팀, 정문석 / (02)8601-406 <input type="checkbox"/> If you have any question on product testing, please contact the person below : Job holder : Electro-Technical Center, Components Assessment Team, M.S. Jung /+82 2 8601-406	

FP511-09-00

첨부 3 : 전기용품안전인증의 변경 현황
Status of Certificate Revisions

변경사항 내용 Contents of Certificate Revisions
Not Applicable

FP511-11-00

접수번호 : 05-1920-5643
(Order No.)



전기용품안전인증서

Electrical Appliances Safety Certificate

안전인증번호 : SU05015-5014
(Certificate No.)

제조업자명 : Suzhou Walter Electronic Co., Ltd.
(Manufacturer)

대표자명 :
(President)

제조공장의 소재지 : Fénhu, Technic Development Zone, Luxu Wu Jiang, Jiangsu,
(Factory Address) P.R. China

제품명 : 소형퓨즈 (Sub-miniature fuse-link)
(Product)

기본모델명 : 2000 6.3A
(Basic Model)

정격 : AC250V, 6.3A
(Rating)

파생모델명 : 2000 5A, 2010 5A, 2010 6.3A
(Series Model)

적용기준 : K60127-1, K60127-3
(Standard)

「전기용품안전 관리법 시행령」 제4조제3항의 규정에 의하여 위의 전기용품에 대하여 안전인증서를 교부합니다.

We Issue Electrical Appliances Safety Certification as above product by Article 4 Section 3 of the Electrical Appliances Safety Control Law Operation Rule.

2006년 03월 06일
year month day



산업기술시험원

KOREA TESTING LABORATORY



- 첨부 : 1. 안전관리부품 및 재질목록 (List of Critical Components)
(Annex) 2. 기본모델·파생모델의 내용 (General Descriptions of Certified Products)
3. 전기용품안전인증의 변경 현황 (Status of Certificate Revisions)

첨부 2 : 기본모델 - 파생모델의 내용
General descriptions of Certified Products

파생모델명 Derivative model(s)	기본모델과의 차이점 Differences between the basic and derivative model(s)
2000 5A	Rated current is different.
2010 5A	Rated current and appearance are different.
2010 6.3A	Rated current and appearance are different.
제품특이사항 및 시험조건 Remarks & Test conditions	
<p>1. Test Report Ref. No. : 05-1920-5643 (2006. 02. 28)</p> <p>2. Product Description</p> <ul style="list-style-type: none"> - Ratings : 250V~, 6.3A - Model : 2000 6.3A - Sub-miniature Fuse links. 	
<p><input type="checkbox"/> 본 제품의 시험내용에 관하여 문의하실 사항이 있으시면 아래 연락처로 문의하시기 바랍니다. 시험담당자 : 전기전자본부, 부품평가팀, 정문식 / (02)8601-406</p> <p><input type="checkbox"/> If you have any question on product testing, please contact the person below : Job holder : Electro-Technical Center, Components Assessment Team, M.S. Jung /+82 2 8601-406</p>	

FP511-09-00

첨부 3 : 전기용품안전인증의 변경 현황
Status of Certificate Revisions

변경발급 내용 Contents of Certificate Revisions
Not Applicable

FP511-11-00

单击下面可查看定价，库存，交付和生命周期等信息

[>>Walter\(华德\)](#)