

1. 適用範圍 / SCOPE

2020 系列表面貼裝保險絲，適用於一般電子設備，特別適用於小型化電子設備。

2020 series SMD Fuse, used in electronic equipment, especially suitable for the miniaturization of electronic equipment.

2. 產品型號 / TYPE

例「example」：

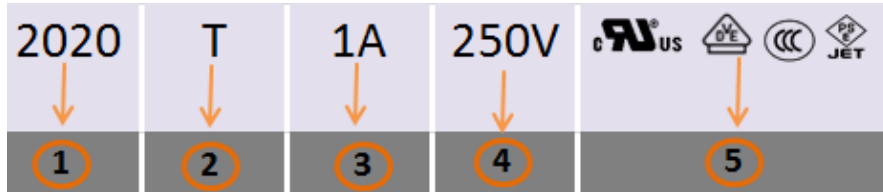

- ① 系列號 / Series Number
- ② 延時性 T / Time-Lag Type
- ③ 額定電流 / Rated Current
- ④ 額定電壓 / Rated Voltage
- ⑤ 認證符號 / Approved Symbol

3. 額定電流和額定電壓 / RATED CURRENT AND RATED VOLTAGE

額定電流 / Rated Current:

100mA~6.3A







額定電壓 / Rated Voltage :

250VAC

4. 標示 / MARKING

保險絲上需有下列標示 / The fuses shall have the following marking:

- ① 製造工廠的標識 / Manufacture' s Logo: 
- ② 電氣特性 / Electrical Characteristic: T (延時性的保險絲符號 symbol for Time-Lag)
- ③ 額定電流 / Rated Current (A): ___A 或 ___mA
- ④ 額定電壓 / Rated Voltage (V): 250VAC
- ⑤ 認證符號 / Approval Marks:

250VAC	100mA~800mA	  
	1.0A~6.3A	   

5. 外觀及形狀 / APPEARANCES AND CONFIGURATION

5-1 外觀不應有顯著的汙點、鐵銹或裂紋; 標示應該容易辨識。

There shall not be any remarkable stain, rust or crack on the appearances; marking shall be easily legible.

5-2 形狀：帶直線引腳的超小型保險絲，增加貼裝構件，方便表面貼裝。

Configuration : Radial leaded Sub-Miniature Fuse , increase the SMT components , convenient and SMT.

6. 工程圖和結構 / OUTLINE DRAWING AND STRUCTURE

6-1 工程圖 (單位元 : mm) / Outline Drawing and Dimensions (Unit: mm)

<散裝>

<Bulk>

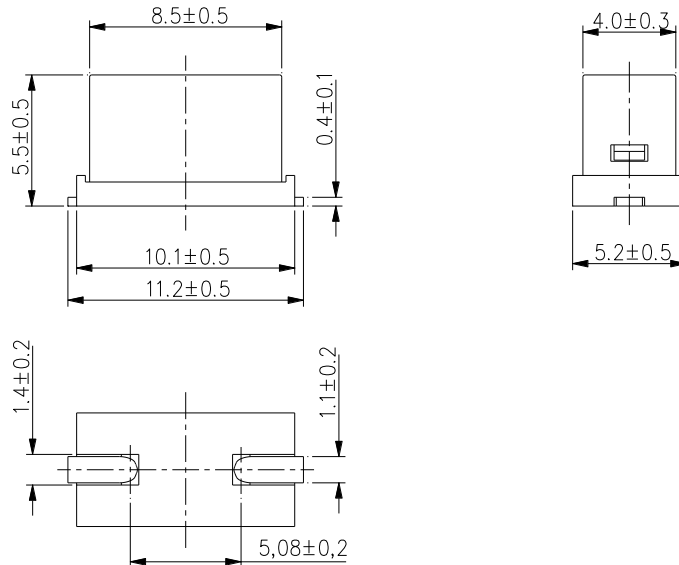

<編帶包裝>

<Taping>

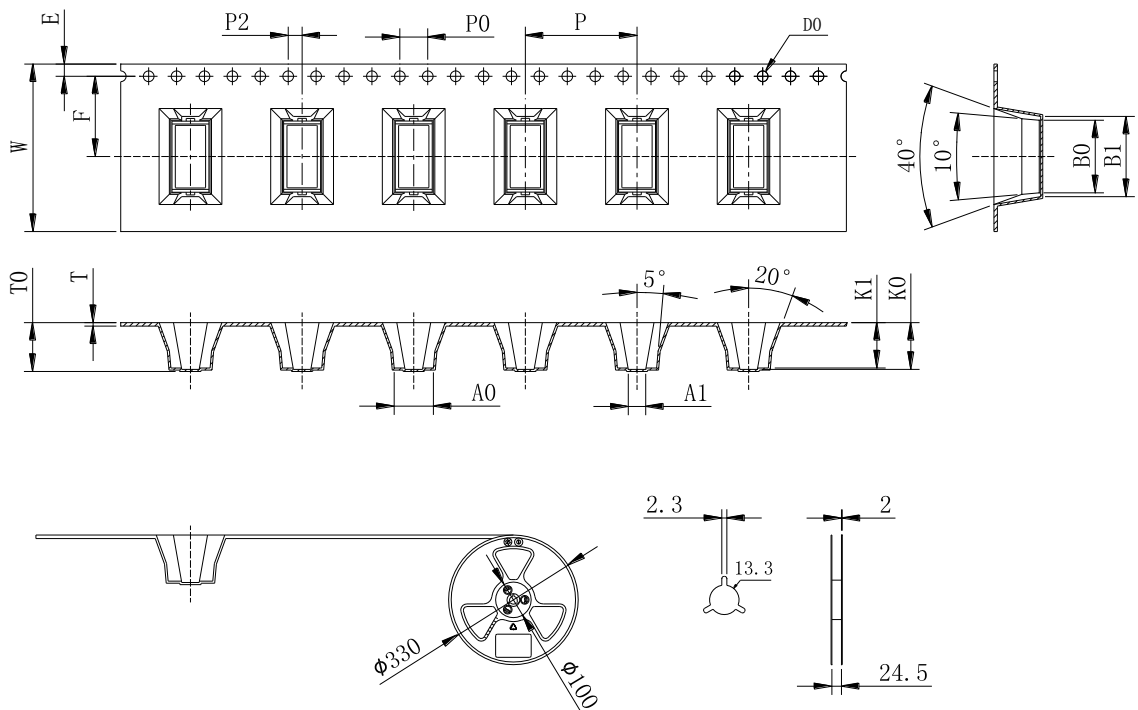

W	24.0±0.3	T	0.4±0.05	P0	4.0±0.1	A0	5.8±0.1	A1	2.5±0.1
T0	6.2±0.1	F	11.5±0.1	P2	2.0±0.1	B0	10.7±0.1	B1	11.7±0.1
E	1.75±0.1	P	16.0±0.1	D0	Ø1.55±0.1	K0	6.0±0.1	K1	6.2±0.1

6-2 結構 / Structure

編號 No.	元件 Component	材質 Material	數量 Quantity
1	本體 Body	耐熱性塑膠 Polyamide Thermoplastic,UL-94-V0	1
2	端子 Termination	鍍錫銅線 Tin Plated Copper	2
3	貼裝構件 SMT components	耐熱性塑膠LCP Thermoplastic,UL-94-V0	1

7. 產品特性 / PRODUCT CHARACTERISTICS

7-1 引腳拉力強度 / Lead Pull Strength

10 牛頓 10±1 秒 / 10N for 10±1 Seconds

7-2 引腳推力強度 / Lead Thrust Strength

2 牛頓 10±1 秒 / 2N for 10±1 Seconds

7-3 可焊性 / Solderability

回流焊/ Reflow soldering : 250°C , ≤3s

7-4 耐焊接熱 / Soldering Heat Resistance

回流焊/ Reflow soldering : 260°C , ≤20s

8. 電氣特性 / ELECTRICAL CHARACTERISTICS

8-1 熔斷 / 電流特性 : Pre-Arcing Time / Current Characteristic (limits)

延遲性保險絲Time-Lag Type

RATED CURRENT	2.1 IN		2.75 IN		4 IN		10 IN	
	Max.	Min.	Max.	Min.	Max.	Min.	Max.	
100mA to 6.3A	2min	400ms	10s	150ms	3s	20ms	150ms	

8-2 分斷能力 / Breaking Capacity

UL	100mA~6.3A	160A/250V AC
VDE	100mA~6.3A	100A/250V AC
CCC	100mA~6.3A	100A/250V AC
PSE	1.0A~6.3A	100A/250V AC
KC	100mA~6.3A	100A/250V AC

9. 環境特性 / ENVIRONMENTAL CHARACTERISTIC

9-1 操作溫度範圍: -55°C ~ 125°C / Operating Temperature: -55°C ~ 125°C

若貴司操作環境溫度超出25±5°C範圍，在選用保險絲規格時，需考慮操作環境溫度對保險絲的影響。
 請參照：溫度-電流曲線圖。

When choosing the fuse's specification, if the operating environmental temperature beyond the scope from 20~30°C, you should consider the environmental temperature's affection to fuses.

please refer:

Temperature-Current curve:

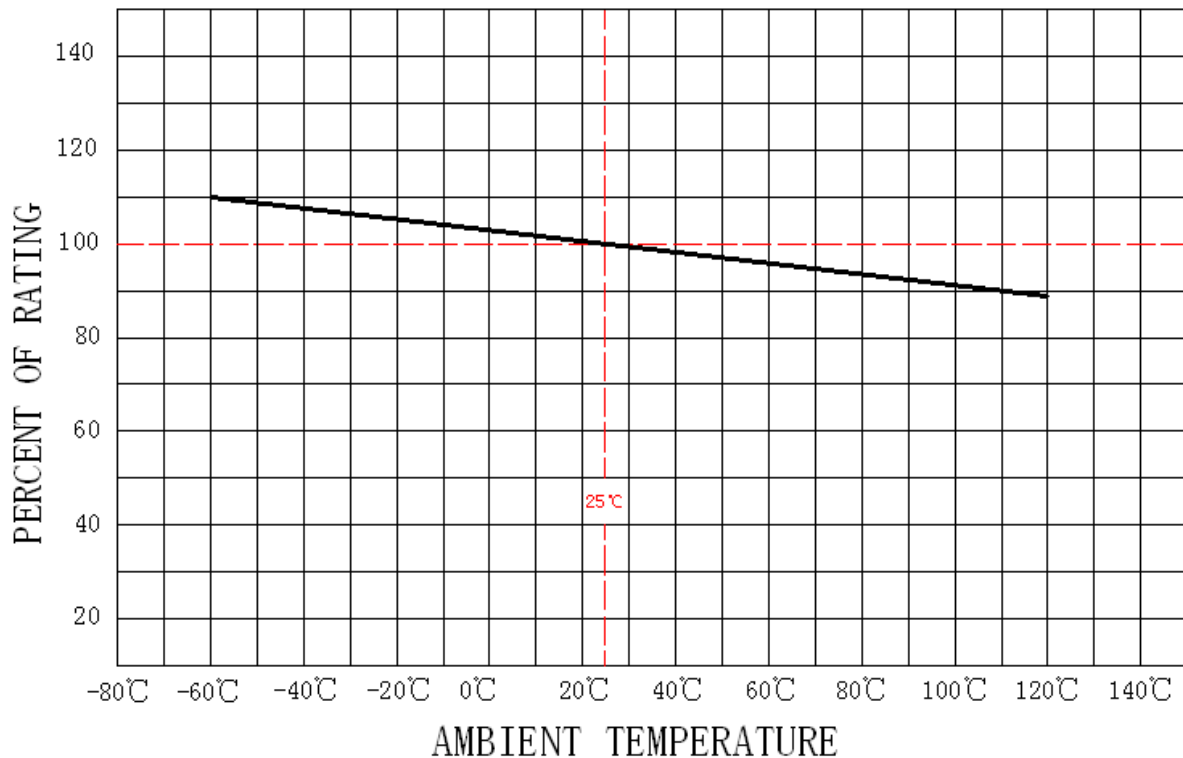

9-2 存儲條件 / Storage Conditions

在溫度+10°C ~ 60°C、相對濕度 ≤ 75% 的密閉條件下可存放 3 年。

Under airtight in temperature +10°C ~ 60°C、relative humidity ≤ 75% can store 3 years.

在溫度+10°C ~ 60°C、相對濕度為 95% 的非露天下最多可存放 30 天。

Without dew in temperature +10°C ~ 60°C、relative humidity be 95% maximum value for 30 days.

10. 安裝方式及條件 / INSTALLATION WAY AND PARAMETERS

10-1 焊墊尺寸建議 / Recommended Size of the Pad

t : 元件焊墊金屬層厚度 (min.) / Thickness of pad metal (min.)

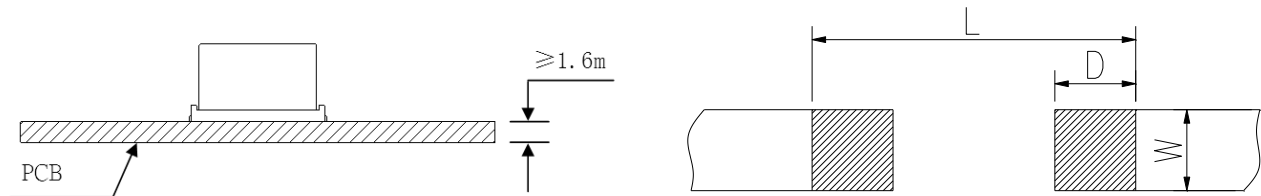

L	W	D	t
12.0mm	≥ 1.5mm	3.0mm	≥ 35μm

10-2 建議客戶焊接參數 / Recommended Customer Soldering Parameters

焊接溫度 / Solder Temperature: 260°C Max

焊接時間 / Solder Dwell Time: ≤ 20s

回流焊參考曲線圖 / Reflow Soldering curve:

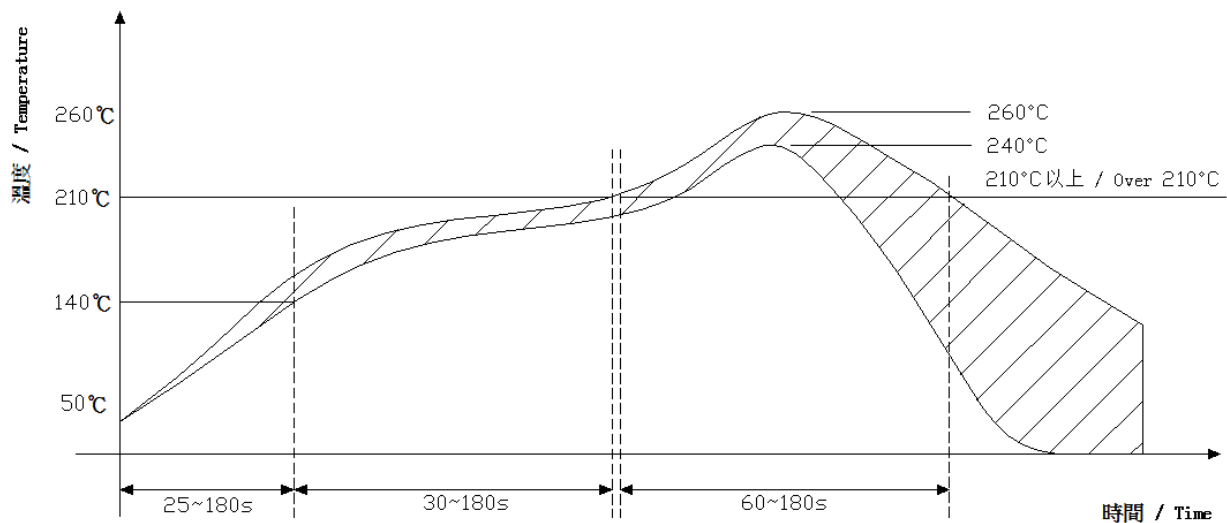

11. 其他使用注意事項 / OTHER NOTICE IN USED

符合本公司可能的其他檔的要求。

It could be in conformance with another file, which made by our company.

12. 安全認證及編號 / STANDARDS AND APPROVALS

UL	E56092 (100mA~6.3A)
VDE	40042706 (100mA~6.3A)
CCC	2019010207205223 (100mA~6.3A)
PSE	JET2179-31007-1002 (1.0A~5.0A) 、JET2179-31007-1001 (6.3A)
KC	SU05015-16004(100mA) 、SU05015-16003(125mA~ 800mA) SU05015-16001(1.0A~ 2.5A) 、SU05015-16002(3.15A~ 6.3A)

13. 包裝 / PACKING

包裝數量 / Packing Quantity

A：編帶包裝每卷 500 個保險絲

Taping package 500 pcs per roll

B：散裝每膠袋 500 個保險絲

Bulk 500 pcs/ poly bag

每盒 2 袋共 1000 個保險絲

2 poly bags / box, altogether 1000 pcs

14. 其他 / OTHERS

14-1 如果在使用中有超出本規格書的要求，必須經由雙方協商確認。

In the event that an impropriety is found beyond this specification ,it shall be fixed by mutual agreement between the parties.

14-2 如果本規格書有不適當的情況，必須通過雙方協商並由本公司修改。

In the event that an impropriety is found in this specification , WALTER ELECTRONIC CO., LTD. shall amend it by mutual agreement between the parties.

版次	製作	確認	審核
第三版	饒紅	蔡明威	



UL iQ for Fuses



Fuses

E56092

Guide Information

SUZHOU WALTER ELECTRONIC CO LTD

Fenhu Technic Development Zone, Wujiang Jiangsu 215211 CN

2020

Supplemental micro fuses: pigtail leads, filled-tube

<u>Size</u> <u>mm(in)</u>	<u>Amps</u> <u>(A)</u>	<u>Volts</u> <u>(V)</u>	<u>Interrupting</u> <u>Rating (A)</u>
8.4 x 4.1 x 5.3 (0.33 x 0.16 x 0.21)	0.1 - 6.3	250Vac	160
	0.1 - 6.3	300Vac	130
	0.1 - 6.3	400Vac	50

Report Date: 2015-03-10

Last Revised: 2018-09-04

© 2018 UL LLC



ZEICHENGENEHMIGUNG MARKS APPROVAL

Suzhou Walter Electronic
Co. Ltd.
Fenhu Technic Development Zone
215211 LUXU TOWN, WUJIANG CITY
Jiangsu
CHINA

ist berechtigt, für ihr Produkt /
is authorized to use for their product

Kleinstsicherungseinsatz
Sub-miniature fuse-link

die hier abgebildeten markenrechtlich geschützten Zeichen
für die ab Blatt 2 aufgeführten Typen zu benutzen /
the legally protected Marks as shown below for the types referred to on page 2 ff.



Geprüft und zertifiziert nach /
Tested and certified according to

DIN EN 60127-1 (VDE 0820-1):2015-12; EN 60127-1:2006+A1:2011+A2:2015
DIN EN 60127-3 (VDE 0820-3):2015-11; EN 60127-3:2015
IEC 60127-1:2006
IEC 60127-1:2006/AMD1:2011
IEC 60127-1:2006/AMD2:2015
IEC 60127-3:2015



Aktenzeichen: 5000410-1170-0031 / 253506

File ref.:

Ausweis-Nr. 40042706

Blatt 1

Certificate No.

Page

Weitere Bedingungen siehe Rückseite und Folgeblätter /
further conditions see overleaf and following pages

Offenbach, 2015-07-27

(letzte Änderung / updated 2018-12-07)

VDE Prüf- und Zertifizierungsinstitut GmbH
VDE Testing and Certification Institute
Zertifizierungsstelle / Certification

R. Nickel

VDE Zertifikate sind nur gültig bei Veröffentlichung unter:
VDE certificates are valid only when published on:

<http://www.vde.com/zertifikat>
<http://www.vde.com/certificate>

Name und Sitz des Genehmigungs-Inhabers / *Name and registered seat of the Certificate holder*

Suzhou Walter Electronic Co. Ltd., Fenu Technic Development Zone, 215211 LUXU TOWN, WUJIANG CITY,
Jiangsu, CHINA

Aktenzeichen / *File ref.*

5000410-1170-0031 / 253506 / TL3 / EUL

letzte Änderung / *updated*

2018-12-07

Datum / *Date*

2015-07-27

Dieses Blatt gilt nur in Verbindung mit Blatt 1 des Zeichengenehmigungsausweises Nr. 40042706.

This supplement is only valid in conjunction with page 1 of the Certificate No. 40042706.

Kleinstsicherungseinsatz *Sub-miniature fuse-link*

Typ(en) / *Type(s)*

2020

Bemessungsspannung
Rated voltage

AC 250 V
AC 300 V (except 6,3A)
AC 400 V (except 6,3A)

Bemessungsstrom
Rated current

100mA; 125mA; 160mA; 200mA; 250mA; 315mA; 400mA;
500mA; 630mA; 800mA; 1A; 1,25A; 1,6A; 2A; 2,5A; 3,15A; 4A;
5A; 6,3A

Normblatt
Standard sheet

4

Kennzeichnung der Charakteristik
Characteristic symbol

T

Bemessungsausschaltvermögen
Rated breaking capacity

50 A (AC 300V; nur/only 100mA bis/up to 500mA)
50 A (AC 400V; except 6,3A)
100 A (AC 250V)
100 A (AC 300V; nur/only 630mA bis/up to 5A)

Zeit/Strom-Charakteristik
Time/current-characteristic

träge
time-lag

Anmerkung

Die Prüfspannung in Abschnitt 9.2 war DC 63 V.
Rechteckige Bauform.

Remark

*The test voltage in clause 9.2 was DC 63 V.
Rectangular shape.*

Fortsetzung siehe Blatt 3 /
continued on page 3

VDE Prüf- und Zertifizierungsinstitut Zeichengenehmigung

Ausweis-Nr. / Blatt /
Certificate No. / Page
40042706 3

Name und Sitz des Genehmigungs-Inhabers / *Name and registered seat of the Certificate holder*

Suzhou Walter Electronic Co. Ltd., Fenu Technic Development Zone, 215211 LUXU TOWN, WUJIANG CITY,
Jiangsu, CHINA

Aktenzeichen / *File ref.*

5000410-1170-0031 / 253506 / TL3 / EUL

letzte Änderung / *updated*

2018-12-07

Datum / *Date*

2015-07-27

Dieses Blatt gilt nur in Verbindung mit Blatt 1 des Zeichengenehmigungsausweises Nr. 40042706.

This supplement is only valid in conjunction with page 1 of the Certificate No. 40042706.

Dieser Zeichengenehmigungs-Ausweis bildet eine Grundlage für die EG-Konformitätserklärung und CE-Kennzeichnung durch den Hersteller oder dessen Bevollmächtigten und bescheinigt die Konformität mit den grundlegenden Schutzanforderungen der **EG-Niederspannungsrichtlinie 2014/35/EU**.

*This Marks Approval is a basis for the EC Declaration of Conformity and the CE Marking by the manufacturer or his agent and proves the conformity with the essential safety requirements of the **EC Low-Voltage Directive 2014/35/EU**.*

VDE Prüf- und Zertifizierungsinstitut GmbH

VDE Testing and Certification Institute

Fachgebiet TL3

Section TL3

VDE Prüf- und Zertifizierungsinstitut Zeichengenehmigung

Ausweis-Nr. / Beiblatt /
Certificate No. Supplement
40042706

Name und Sitz des Genehmigungs-Inhabers / *Name and registered seat of the Certificate holder*

Suzhou Walter Electronic Co. Ltd., Fenu Technic Development Zone, 215211 LUXU TOWN, WUJIANG CITY,
Jiangsu, CHINA

Aktenzeichen / *File ref.*

5000410-1170-0031 / 253506 / TL3 / EUL

letzte Änderung / *updated*

2018-12-07

Datum / *Date*

2015-07-27

Dieses Beiblatt ist Bestandteil des Zeichengenehmigungsausweises Nr. 40042706.

This supplement is part of the Certificate No. 40042706.

Kleinstsicherungseinsatz

Sub-miniature fuse-link

Fertigungsstätte(n)

Place(s) of manufacture

Referenz/*Reference*

30006375

Dongguan Walter Electric Co., Ltd.

Yan Tian, Feng Gang Town

523702 DONGGUAN CITY

Guangdong

CHINA

Referenz/*Reference*

30011941

Suzhou Walter Electronic

Co. Ltd.

Fenu Technic Development Zone

215211 LUXU TOWN, WUJIANG CITY

Jiangsu

CHINA

VDE Prüf- und Zertifizierungsinstitut GmbH

VDE Testing and Certification Institute

Fachgebiet TL3

Section TL3



Name und Sitz des Genehmigungs-Inhabers / Name and registered seat of the Certificate holder

Suzhou Walter Electronic Co. Ltd., Fenuh Technic Development Zone, 215211 LUXU TOWN, WUJIANG CITY,
Jiangsu, CHINA

Aktenzeichen / File ref.

5000410-1170-0031 / 253506 / TL3 / EUL

letzte Änderung / updated

2018-12-07

Datum / Date

2015-07-27

Dieses Blatt gilt nur in Verbindung mit Blatt 1 des Zeichengenehmigungsausweises Nr. 40042706.

This supplement is only valid in conjunction with page 1 of the Certificate No. 40042706.

Genehmigung zum Benutzen des auf Seite 1 abgebildeten markenrechtlich geschützten Zeichens des VDE:

Grundlage für die Benutzung sind die Allgemeinen Geschäftsbedingungen (AGB) der VDE Prüf- und Zertifizierungsinstitut GmbH (www.vde.com\AGB-Institut). Das Recht zur Benutzung erstreckt sich nur auf die bezeichnete Firma mit den genannten Fertigungsstätten und die oben aufgeführten Produkte mit den zugeordneten Bezeichnungen. Die Fertigungsstätte muss so eingerichtet sein, dass eine gleichmäßige Herstellung der geprüften und zertifizierten Ausführung gewährleistet ist.

Die Genehmigung ist so lange gültig wie die VDE-Bestimmungen gelten, die der Zertifizierung zugrunde gelegen haben, sofern sie nicht auf Grund anderer Bedingungen aus der VDE Prüf- und Zertifizierungsordnung (PM102) zurückgezogen werden muss.

Der Gültigkeitszeitraum einer VDE-GS-Zeichengenehmigung kann auf Antrag verlängert werden. Bei gesetzlichen und / oder normativen Änderungen kann die VDE-GS-Zeichengenehmigung ihre Gültigkeit zu einem früheren als dem angegebenen Datum verlieren.

Produkte, die das Biozid Dimethylfumarat (DMF) enthalten, dürfen gemäß der Kommissionsentscheidung 2009/251/EG nicht mehr in den Verkehr gebracht oder auf dem Markt bereitgestellt werden.

Der VDE-Zeichengenehmigungsausweis wird ausschließlich auf der ersten Seite unterzeichnet.

Approval to use the legally protected Mark of the VDE as shown on the first page:

Basis for the use are the general terms and conditions of the VDE Testing and Certification Institute (www.vde.com\terms-institute). The right to use the mark is granted only to the mentioned company with the named places of manufacture and the listed products with the related type references. The place of manufacture shall be equipped in a way that a constant manufacturing of the certified construction is assured.

The approval is valid as long as the VDE specifications are in force, on which the certification is based on, unless it is withdrawn according to the VDE Testing and Certification Procedure (PM102E).

The validity period of a VDE-GS-Mark Approval may be prolonged on request. In case of changes in legal and / or normative requirements, the validity period of a VDE-GS-Mark Approval may be shortened.

Products containing the biocide dimethylfumarate (DMF) may not be marketed or made available on the EC market according to the Commission Decision 2009/251/EC.

The approval is solely signed on the first page.



中国国家强制性产品认证证书

证书编号：2019010207205223

委托人名称、地址

华德电子股份有限公司
台北市士林区重庆北路4段97号2楼

生产者（制造商）名称、地址

华德电子股份有限公司
台北市士林区重庆北路4段97号2楼

生产企业名称、地址

苏州华德电子有限公司
江苏省吴江汾湖经济开发区新黎路99号

产品名称和系列、规格、型号

超小型熔断体

2020 T100mA250V、2020 T125mA250V、2020 T160mA250V、2020 T200mA250V、2020 T250mA250V、2020 T315mA250V、2020 T400mA250V、2020 T500mA250V、2020 T630mA250V、2020 T800mA250V、2020 T1A250V、2020 T1.25A250V、2020 T1.6A250V、2020 T2A250V、2020 T2.5A250V、2020 T3.15A250V、2020 T4A250V、2020 T5A250V、2020 T6.3A250V

产品标准和技术要求

GB/T9364.3-2018; GB/T9364.1-2015

上述产品符合强制性产品认证实施规则 CNCA-C02-01:2014 的要求，特发此证。

发证日期：2019年07月19日 有效期至：2024年07月19日

证书有效期内本证书的有效性依据发证机构的定期监督获得保持。

本证书的相关信息可通过国家认监委网站 www.cnca.gov.cn 查询



主任：

陆梅



中国质量认证中心



CERTIFICATE FOR CHINA COMPULSORY PRODUCT CERTIFICATION

CERTIFICATE NO.: 2019010207205223

NAME AND ADDRESS OF THE APPLICANT

Walter Electronic Co., Ltd
2nd Floor, 97 Chung King North Road Section 4, Taipei City, Taiwan

NAME AND ADDRESS OF THE MANUFACTURER

Walter Electronic Co., Ltd
2nd Floor, 97 Chung King North Road Section 4, Taipei City, Taiwan

NAME AND ADDRESS OF THE FACTORY

Suzhou Walter Electronic Co., Ltd.
South of Xinli Road, Fenhu Technic Development Zone, Luxu, Wujiang City, Jiangsu

PRODUCT NAME, MODEL AND SPECIFICATION

Sub-miniature Fuse-link

2020 T100mA250V、2020 T125mA250V、2020 T160mA250V、2020 T200mA250V、2020 T250mA250V、2020 T315mA250V、2020 T400mA250V、2020 T500mA250V、2020 T630mA250V、2020 T800mA250V、2020 T1A250V、2020 T1.25A250V、2020 T1.6A250V、2020 T2A250V、2020 T2.5A250V、2020 T3.15A250V、2020 T4A250V、2020 T5A250V、2020 T6.3A250V

THE STANDARDS AND TECHNICAL REQUIREMENTS FOR THE PRODUCTS

GB/T9364.3-2018;GB/T9364.1-2015

This is to certify that the above mentioned product(s) complies with the requirements of implementation rules for compulsory certification(REFNO.CNCA-C02-01:2014).

Valid from: Jul.19,2019

Valid until: Jul.19,2024

The validity of the certificate is subject to positive result of the regular follow up inspection by issuing certification body until the expiry date.

The certificate information is available through CNCA's website: www.cnca.gov.cn



President:

Lu Mei



CHINA QUALITY CERTIFICATION CENTRE

<http://www.cqc.com.cn>

Section 9, No. 188, Nansihuan Xilu, Beijing 100070 P. R. China

Tel: +86 10 83886666

Q 2367717

適合性同等検査合格書

Statement of Conformity Assessment

電気用品安全法第8条第1項に規定する技術基準及び同法第9条第2項の経済産業省令で定める基準（法第9条第1項第2号に係る検査に係るものに限る）に適合していることを証明します

I hereby certify that the product mentioned below complies with the technical requirements stipulated in Paragraph 1 of Article 8 of Electrical Appliance and Material Safety Law (hereunder referred to as the Law) and the requirements defined by the ordinance of the Ministry of Economy, Trade and Industry based on Paragraph 2 of Article 9 of the Law (limited to Item 2 of Paragraph 1 of Article 9 for Inspection of the Law).

1. 合格書番号: JET2179-31007-1001
Statement Number
2. 交付年月日: 平成24年9月29日
Effective Date September 29, 2012
3. 有効年月日: 平成31年9月28日
Date of Validity September 28, 2019
4. 申込者名 (Applicant)
住所: FENHU TECHNIC DEVELOPMENT ZONE WUJIANG, JIANGSU PROVINCE, CHINA
Address

氏名又は名称: SUZHOU WALTER ELECTRONIC CO., LTD.
Name

5. 特定電気用品名: その他の包装ヒューズ
Name of Product Other enclosed fuses
6. 型式の区分: 別紙のとおり
Type Classification See attached "Type Classification"
7. 製造工場名 (Manufacturer)
住所: FENHU TECHNIC DEVELOPMENT ZONE WUJIANG, JIANGSU PROVINCE, CHINA
Address

氏名又は名称: SUZHOU WALTER ELECTRONIC CO., LTD.
Name

8. 適用試験規格: 電気用品の技術上の基準を定める省令第1項
Applied Standard for Testing Article 1 of The Technical Requirements of the METI Ordinance
別表第三 2

Appendix 3 Section 2

9. 適合性検査の方法: (Testing Method for Conformity Assessment)

- 1) 試験用の特定電気用品については、電気用品の技術上の基準を定める省令に定める方法

With respect to testing for Category A products, the testing method is based on the technical requirements of the Electrical Appliance and Material stipulated in the METI Ordinance.

- 2) 当該特定電気用品に係る届出事業者又は事業場における検査設備については、電気用品安全法施行規則別表第四の検査設備の欄に掲げる検査設備ごとにそれぞれ同表の技術上の基準の欄に掲げる方法

With respect to inspection facilities required for Category A products at the factory, Testing Method described in the column of the technical requirements for each inspection facilities in the column of inspection facilities is shown in the Appendix 4 of Enforcement Regulations of the Law.

一般財団法人 電気安全環境研究所
Japan Electrical Safety & Environment technology Laboratories (JET)

理事長 末廣 恵雄
President Shigeo Suehiro

東京都渋谷区代々木5-14-12 (5-14-12, Yoyogi, Shibuya-ku, Tokyo)

適合性同等検査合格書別紙

Statement of Conformity Assessment

型式の区分

Type Classification

要素 Factor	区分 Classification
定格電圧 Rated voltage	(2) 125Vを超えるもの Exceeding 125V
定格電流（定格電流表示のあるものに限る。） Rated current (limited to those with rated current markings)	(2) 5Aを超え15A以下のもの Exceeding 5A, and less than or equal to 15A
可溶体の主材料 Fuse element materials	(5) 銅のもの Copper
可溶体の数 Number of fuse elements	(1) 1のもの One
再使用（管形ヒューズを除く。） Reusability (excluding cartridge fuses)	(2) できないもの Not reusable
内部充てん物 Filler materials	(1) あるもの With filler materials
筒（内筒を除く。）の材料（管形ヒューズ、筒形ヒューズ及びその他の包装ヒューズの場合に限る。） Outer cartridge materials (limited to cartridge fuses, tubular fuses, and other enclosed fuses)	(7) その他のもの Others
端子（栓形ヒューズの場合を除く。） Terminals (excluding plug fuse (formerly known as end contact plug fuses))	(5) その他のもの Others
排気孔 Exhausting opening	(2) ないもの Without exhausting opening
溶断の表示 Blowout fuse indicator	(2) ないもの Without blowout fuse indicator
用途 Application	(2) 電子機器用のもの For use in electric appliances
定格遮断電流 Rated breaking capacity	(1) 100A以下のもの 100A or less

合格書番号：JET2179-31007-1001

2 / 2

適合性同等検査合格書

Statement of Conformity Assessment

電気用品安全法第8条第1項に規定する技術基準及び同法第9条第2項の経済産業省令で定める基準（法第9条第1項第2号に係る検査に係るものに限る）に適合していることを証明します

I hereby certify that the product mentioned below complies with the technical requirements stipulated in Paragraph 1 of Article 8 of Electrical Appliance and Material Safety Law (hereunder referred to as the Law) and the requirements defined by the ordinance of the Ministry of Economy, Trade and Industry based on Paragraph 2 of Article 9 of the Law (limited to Item 2 of Paragraph 1 of Article 9 for Inspection of the Law).

1. 合格書番号: JET2179-31007-1002
Statement Number
2. 交付年月日: 平成24年9月29日
Effective Date September 29, 2012
3. 有効年月日: 平成31年9月28日
Date of Validity September 28, 2019
4. 申込者名 (Applicant)
住所: FENHU TECHNIC DEVELOPMENT ZONE WUJIANG, JIANGSU PROVINCE, CHINA
Address

氏名又は名称: SUZHOU WALTER ELECTRONIC CO., LTD.
Name

5. 特定電気用品名: その他の包装ヒューズ
Name of Product Other enclosed fuses
6. 型式の区分: 別紙のとおり
Type Classification See attached "Type Classification"
7. 製造工場名 (Manufacturer)
住所: FENHU TECHNIC DEVELOPMENT ZONE WUJIANG, JIANGSU PROVINCE, CHINA
Address

氏名又は名称: SUZHOU WALTER ELECTRONIC CO., LTD.
Name

8. 適用試験規格: 電気用品の技術上の基準を定める省令第1項
Applied Standard for Testing Article 1 of The Technical Requirements of the METI Ordinance
別表第三2

Appendix 3 Section 2

9. 適合性検査の方法: (Testing Method for Conformity Assessment)

- 1) 試験用の特定電気用品については、電気用品の技術上の基準を定める省令に定める方法

With respect to testing for Category A products, the testing method is based on the technical requirements of the Electrical Appliance and Material stipulated in the METI Ordinance.

- 2) 当該特定電気用品に係る届出事業者又は事業場における検査設備については、電気用品安全法施行規則別表第四の検査設備の欄に掲げる検査設備ごとにそれぞれ同表の技術上の基準の欄に掲げる方法

With respect to inspection facilities required for Category A products at the factory, Testing Method described in the column of the technical requirements for each inspection facilities in the column of inspection facilities in the Appendix 4 of Enforcement Regulations of the Law.

一般財団法人 電気安全環境研究所
Japan Electrical Safety & Environment technology Laboratories (JET)

理事長 末廣 恵雄
President Shigeo Suehiro

東京都渋谷区代々木5-14-12 (5-14-12, Yoyogi, Shibuya-ku, Tokyo)

適合性同等検査合格書別紙

Statement of Conformity Assessment

型式の区分

Type Classification

要素 Factor	区分 Classification
定格電圧 Rated voltage	(2) 125Vを超えるもの Exceeding 125V
定格電流（定格電流表示のあるものの場合に限る。） Rated current (limited to those with rated current markings)	(1) 5 A以下のもの 5A or less
可溶体の主材料 Fuse element materials	(5) 銅のもの Copper
可溶体の数 Number of fuse elements	(1) 1のもの One
再使用（管形ヒューズを除く。） Reusability (excluding cartridge fuses)	(2) できないもの Not reusable
内部充てん物 Filler materials	(1) あるもの With filler materials
筒（内筒を除く。）の材料（管形ヒューズ、筒形ヒューズ及びその他の包装ヒューズの場合に限る。） Outer cartridge materials (limited to cartridge fuses, tubular fuses, and other enclosed fuses)	(7) その他のもの Others
端子（栓形ヒューズの場合を除く。） Terminals (excluding plug fuse (formerly known as end contact plug fuses))	(5) その他のもの Others
排気孔 Exhausting opening	(2) ないもの Without exhausting opening
溶断の表示 Blowout fuse indicator	(2) ないもの Without blowout fuse indicator
用途 Application	(2) 電子機器用のもの For use in electric appliances
定格遮断電流 Rated breaking capacity	(1) 100A以下のもの 100A or less

合格書番号：JET2179-31007-1002

— 2 / 2 —

접수번호 : 16-001912-01
(Receipt No.)



전기용품안전인증서

Electrical Appliances Safety Certificate

안전인증번호 : SU05015-16001
(Certificate No.)

제조업자명 : Suzhou Walter Electronic Co., Ltd.
(Manufacturer)

대표자명 : Mr. Yen Chun Chang
(President)

제조공장의 주소 : Fenhu, Technic Development Zone, Luxu Wu Jiang, Jiangsu,
(Factory Address) P.R.China

제품명 : 퓨즈(Sub-miniature fuse-link)
(Product)

기본모델명 : 2020 T2.5A 250V
(Basic Model)

정격 : 250 VAC, 2.5 A, 100 A
(Rating)

파생모델명 : See the attachment 2
(Series Model)

적용기준 : KC60127-3(2015-09), K60127-1(2011-12)
(Standard)

「전기용품안전 관리법 시행규칙」 제6조제2항에 따라 위의 전기용품에 대하여 안전인증서를 발급합니다.

We issue Electrical Appliances Safety Certification as above product by Article 6 Section 2 of the Electrical Appliances Safety Control Law Enforcement Regulation.

2016년 02월 05일
Year month day



한국산업기술시험원장
KOREA TESTING LABORATORY



* 이 인증서는 「전기용품안전 관리법」에 따른 전기용품 안전성 확인에 한정된 것이며, 그 밖의 다른 법률이 적용되는 제품의 경우에는 해당 법률에 따라 추가로 인증·허가 등을 받아야 합니다.

- 첨부 :
(Annex)
1. 안전관리부품 및 재질목록 (List of Critical Components)
 2. 기본모델·파생모델의 내용 (Descriptions of the basic and series model)
 3. 전기용품안전인증의 변경 현황 (Revisions Status)

첨부 2 : 기본모델 · 파생모델의 내용
General description of Certified Products

파생모델명 Derivative model	기본모델과의 차이점 Differences between the basic and derivative model(s)
2020 T1A 250V	Rated current(1 A) is different
2020 T1.25A 250V	Rated current(1.25 A) is different
2020 T1.6A 250V	Rated current(1.6 A) is different
2020 T2A 250V	Rated current(2 A) is different
제품특기사항 및 시험조건 Remarks & Test conditions	
<p>1. Test report number: 16-001912-01 (2016.02.04.)</p> <p>2. Product Description</p> <ul style="list-style-type: none"> - 250 VAC, 2.5 A - Rated Breaking capacity : 100 A - Standard sheet 4 	
<p><input type="checkbox"/> 본 제품의 시험내용에 관하여 문의하실 사항이 있으시면 아래 연락처로 문의하시기 바랍니다. 시험담당자: 디지털산업본부 디지털남부사업센터 임화준 / (055) 791-3431</p> <p><input type="checkbox"/> <i>If you have any question on product testing, please contact the person below :</i> <i>Job holder : Lighting Appliances & Electrical Components Testing Center H.J Rim /+82 55 791-3431</i></p>	

FP511-09-00

첨부 3 : 전기용품안전인증의 변경 현황
Status of Certificate Revisions

변경발급 내용 Contents of Certificate Revisions
Not applicable

FP511-11-00

접수번호 : 16-001912-02
(Receipt No.)



전기용품안전인증서

Electrical Appliances Safety Certificate

안전인증번호 : SU05015-16002
(Certificate No.)

제조업자명 : Suzhou Walter Electronic Co., Ltd.
(Manufacturer)

대표자명 : Mr. Yen Chun Chang
(President)

제조공장의 주소 : Fenhu, Technic Development Zone, Luxu Wu Jiang, Jiangsu,
(Factory Address) P.R.China

제품명 : 퓨즈(Sub-miniature fuse-link)
(Product)

기본모델명 : 2020 T6.3A 250V
(Basic Model)

정격 : 250 VAC, 6.3 A, 100 A
(Rating)

파생모델명 : 2020 T3.15A 250V, 2020 T4A 250V, 2020 T5A 250V
(Series Model)

적용기준 : KC60127-3(2015-09), K60127-1(2011-12)
(Standard)

「전기용품안전 관리법 시행규칙」 제6조제2항에 따라 위의 전기용품에 대하여 안전인증서를 발급합니다.

We Issue Electrical Appliances Safety Certification as above product by Article 6 Section 2 of the Electrical Appliances Safety Control Law Enforcement Regulation.

2016년 02월 12일
Year month day



한국산업기술시험원장
KOREA TESTING LABORATORY



※ 이 인증서는 「전기용품안전 관리법」에 따른 전기용품 안전성 확인에 한정된 것이며, 그 밖의 다른 법률이 적용되는 제품의 경우에는 해당 법률에 따라 추가로 인증·허가 등을 받아야 합니다.

- 첨부 :
(Annex)
1. 안전관리부품 및 재질목록 (List of Critical Components)
 2. 기본모델·파생모델의 내용 (Descriptions of the basic and series model)
 3. 전기용품안전인증의 변경 현황 (Revisions Status)

첨부 2 : 기본모델 · 파생모델의 내용
General description of Certified Products

파생모델명 Derivative model	기본모델과의 차이점 Differences between the basic and derivative model(s)
2020 T3.15A 250V	Rated current(3.15 A) is different
2020 T4A 250V	Rated current(4 A) is different
2020 T5A 250V	Rated current(5 A) is different
제품특기사항 및 시험조건 Remarks & Test conditions	
<p>1. Test report number: 16-001912-02 (2016.02.11.)</p> <p>2. Product Description</p> <ul style="list-style-type: none"> - 250 VAC, 6.3 A - Rated Breaking capacity : 100 A - Standard sheet 4 	
<p><input type="checkbox"/> 본 제품의 시험내용에 관하여 문의하실 사항이 있으시면 아래 연락처로 문의하시기 바랍니다. 검토담당자: 디지털산업본부 디지털남부사업센터 임화준 / (055) 791-3431</p> <p><input type="checkbox"/> <i>If you have any question on product testing, please contact the person below :</i> <i>Job holder : Lighting Appliances & Electrical Components Testing Center H.J Rim /+82 55 791-3431</i></p>	

FP511-09-00

첨부 3 : 전기용품안전인증의 변경 현황
Status of Certificate Revisions

변경발급 내용 Contents of Certificate Revisions
Not applicable

FP511-11-00

접수번호 : 16-001912-04
(Receipt No.)



전기용품안전인증서

Electrical Appliances Safety Certificate

안전인증번호 : SU05015-16003
(Certificate No.)

제조업자명 : Suzhou Walter Electronic Co., Ltd.
(Manufacturer)

대표자명 : Mr. Yen Chun Chang
(President)

제조공장의 주소 : Fenhu, Technic Development Zone, Luxu Wu Jiang, Jiangsu,
(Factory Address) P.R.China

제품명 : 퓨즈(Sub-miniature fuse-link)
(Product)

기본모델명 : 2020 T800mA 250V
(Basic Model)

정격 : 250 VAC, 800 mA, 100 A
(Rating)

파생모델명 : See the attachment 2
(Series Model)

적용기준 : KC60127-3(2015-09), K60127-1(2011-12)
(Standard)

「전기용품안전 관리법 시행규칙」 제6조제2항에 따라 위의 전기용품에 대하여 안전인증서를 발급합니다.

We issue Electrical Appliances Safety Certification as above product by Article 6 Section 2 of the Electrical Appliances Safety Control Law Enforcement Regulation.

2016년 02월 12일
Year month day



한국산업기술시험원장
KOREA TESTING LABORATORY



* 이 인증서는 「전기용품안전 관리법」에 따른 전기용품 안전성 확인에 한정된 것이며, 그 밖의 다른 법률이 적용되는 제품의 경우에는 해당 법률에 따라 추가로 인증·허가 등을 받아야 합니다.

- 첨부 :
(Annex)
1. 안전관리부품 및 재질목록 (List of Critical Components)
 2. 기본모델·파생모델의 내용 (Descriptions of the basic and series model)
 3. 전기용품안전인증의 변경 현황 (Revisions Status)

첨부 2 : 기본모델 · 파생모델의 내용
General description of Certified Products

파생모델명 Derivative model	기본모델과의 차이점 Differences between the basic and derivative model(s)
2020 T125mA 250V	Rated Current(125 mA) is different.
2020 T160mA 250V	Rated Current(160 mA) is different.
2020 T200mA 250V	Rated Current(200 mA) is different.
2020 T250mA 250V	Rated Current(250 mA) is different.
2020 T315mA 250V	Rated Current(315 mA) is different.
2020 T400mA 250V	Rated Current(400 mA) is different.
2020 T500mA 250V	Rated Current(500 mA) is different.
2020 T630mA 250V	Rated Current(630 mA) is different.
제품특기사항 및 시험조건 Remarks & Test conditions	
<p>1. Test report number: 16-001912-04 (2016.02.11.)</p> <p>2. Product Description</p> <ul style="list-style-type: none"> - 250 VAC, 800 mA - Rated Breaking capacity : 100 A - Standard sheet 4 	
<p><input type="checkbox"/> 본 제품의 시험내용에 관하여 문의하실 사항이 있으시면 아래 연락처로 문의하시기 바랍니다. 검토담당자: 디지털산업본부 디지털남부사업센터 임화준 / (055) 791-3431</p> <p><input type="checkbox"/> <i>If you have any question on product testing, please contact the person below :</i> <i>Job holder : Lighting Appliances & Electrical Components Testing Center H.J Rim /+82 55 791-3431</i></p>	

FP511-09-00

첨부 3 : 전기용품안전인증의 변경 현황
Status of Certificate Revisions

변경발급 내용 Contents of Certificate Revisions
Not applicable

FP511-11-00

접수번호 : 16-001912-03
(Receipt No.)



전기용품안전인증서

Electrical Appliances Safety Certificate

안전인증번호 : SU05015-16004
(Certificate No.)

제조사명 : Suzhou Walter Electronic Co., Ltd.
(Manufacturer)

대표자명 : Mr. Yen Chun Chang
(President)

제조공장의 주소 : Fenhu, Technic Development Zone, Luxu Wu Jiang, Jiangsu,
(Factory Address) P.R.China

제품명 : 퓨즈(Sub-miniature fuse-link)
(Product)

기본모델명 : 2020 T100mA 250V
(Basic Model)

정격 : 250 VAC, 100 mA, 100 A
(Rating)

파생모델명 : Not Applicable
(Series Model)

적용기준 : KC60127-3(2015-09), K60127-1(2011-12)
(Standard)

「전기용품안전 관리법 시행규칙」 제6조제2항에 따라 위의 전기용품에 대하여 안전인증서를 발급합니다.

We issue Electrical Appliances Safety Certification as above product by Article 6 Section 2 of the Electrical Appliances Safety Control Law Enforcement Regulation.

2016년 02월 17일
Year month day



한국산업기술시험원장
KOREA TESTING LABORATORY



* 이 인증서는 「전기용품안전 관리법」에 따른 전기용품 안전성 확인에 한정된 것이며, 그 밖의 다른 법률이 적용되는 제품의 경우에는 해당 법률에 따라 추가로 인증·허가 등을 받아야 합니다.

- 첨부 :
(Annex)
1. 안전관리부품 및 재질목록 (List of Critical Components)
 2. 기본모델·파생모델의 내용 (Descriptions of the basic and series model)
 3. 전기용품안전인증의 변경 현황 (Revisions Status)

첨부 2 : 기본모델 · 파생모델의 내용
General description of Certified Products

파생모델명 Derivative model	기본모델과의 차이점 Differences between the basic and derivative model(s)
Not applicable	
제품특기사항 및 시험조건 Remarks & Test conditions	
<p>1. Test report number: 16-001912-03 (2016.02.11.)</p> <p>2. Product Description</p> <ul style="list-style-type: none"> - 250 VAC, 100 mA - Rated Breaking capacity : 100 A - Standard sheet 4 	
<p><input type="checkbox"/> 본 제품의 시험내용에 관하여 문의하실 사항이 있으시면 아래 연락처로 문의하시기 바랍니다. 검토담당자: 디지털산업본부 디지털남부사업센터 임화준 / (055) 791-3431</p> <p><input type="checkbox"/> <i>If you have any question on product testing, please contact the person below :</i> <i>Job holder : Lighting Appliances & Electrical Components Testing Center H.J Rim /+82 55 791-3431</i></p>	

FP511-09-00

첨부 3 : 전기용품안전인증의 변경 현황
Status of Certificate Revisions

변경발급 내용 Contents of Certificate Revisions
Not applicable

FP511-11-00

单击下面可查看定价，库存，交付和生命周期等信息

[>>Walter\(华德\)](#)