

静电保护元件 ESD (Electrostatic Discharge Devices)

YINT静电保护元件阵列可保护电子设备免受雷击和静电放电（ESD）等快速瞬态电压的破坏，为输入/输出接口和数字与模拟信号线提供了理想的保护方案。

Yint的ESD器件封装通常包括：SOD323, SOD523, SOD882, SOD923, SOT23, SOT553, SOT563, SOT353, SOT363, SOT143, SOT23-6L, SOP-8, and μ DFN等。

The array of ESD could preventing electronic equipment from damaging by fast transient voltages such as lightning and electrostatic discharge (ESD), providing an effective protection solution for input/output interfaces and digital and analog signal lines.

The packaging of ESD including: SOD323, SOD523, SOD882, SOD923, SOT23, SOT553, SOT563, SOT353, SOT363, SOT143, SOT23-6L, SOP-8, μ DFN, etc.



特点 Features

- ▲ 响应速度快 Fast response time
- ▲ 小尺寸封装 Small package size
- ▲ 低钳位电压 Low clamping voltage
- ▲ 低漏电流 Low leakage current
- ▲ YINT可提供三种类型的ESD器件：标准电容（大于100pf）,低电容（5-100pF）,超低电容（小于5pf）
YINT offers three types of TVS Diode Arrays: Standard Capacitance(more than 100pF), Low Capacitance (5-100pF), Ultra Low Capacitance(less than 5pF)
- ▲ 符合IEC 61000-4-2(ESD) : Air 15KV , Contact 8KV
Compatible with IEC 61000-4-2(ESD) : Air 15KV , Contact 8KV

Some of the applications discussed in this guide are:

- | | | |
|------------------------|------------------------------|---------------------------------|
| ▲ USB1.1/2.0/3.0 | ▲ 1394a/b | ▲ RS-232 |
| ▲ HDMI | ▲ LVDS | ▲ RS-485 |
| ▲ DisplayPort | ▲ Audio (Speaker/Microphone) | ▲ CAN Bus |
| ▲ DVI | ▲ Analog Video | ▲ Keypad/Push button |
| ▲ 10/100/1000 Ethernet | ▲ SIM Sockets | ▲ LCD/Camera display interfaces |
| ▲ eSATA | | |

Many of these applications can be found in electronic devices such as:

- ▲ PC' s
- ▲ Portable Medical Devices
- ▲ Set Top Boxes
- ▲ LCD/PDP
- ▲ Portable Navigation Devices
- ▲ Keyboards/Mouse
- ▲ Mobile Handsets
- ▲ MP3/PMP' s
- ▲ PDA' s
- ▲ Digital Cameras
- ▲ SIM/SD Cards
- ▲ External Storage
- ▲ Switches/Routers
- ▲ Smart Phone



Definitions and Terms

Reverse Standoff Voltage(V_{RWM})

The V_{RWM} of ESD should be equal to, or greater than the peak operating voltage of circuit(or part of the circuit)to be protected.This is to ensure the normal operation of circuit will not be affected.

Reverse breakdown Voltage(V_{BR})

Clamp Voltage(V_C)

Maximum voltage which can be measured across the protector when subjected to the maximum peak pulse current

Reverse Leakage Current(I_R)

Maximum of state current measured at specified voltage

Junction Capacitance (C)

$V_R=0V$, $f = 1MHz$ Between I/O pins or Any I/O pin to ground

术语定义

反向关断电压 (V_{RWM})

ESD的 V_{RWM} 必须大于或者等于被保护电路（或者被保护电路一部分）的峰值操作电压，这是为了确保ESD器件不影响电路的正常工作。

反向击穿电压(V_{BR})

钳位电压 (V_C)

当受到最大的浪涌电流冲击时，保护器件两端测量到的最大电压

反向漏电流 (I_R)

在额定电压下最大的漏电流

结电容 (C)

I/O pin之间或I/O pin与地之间的寄生电容

SOD323

Part number	VRWM	IR (μA)	VBR (V)	IT(mA)	VC (V) @IPP=1A	Ppk	C	PACKAGE
	(V)	@ VRWM	@ IT			(W)	(pF)	

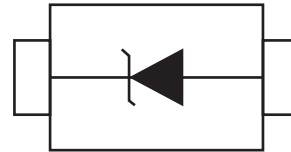

ESD3V3D3	3.3	10	5	1	6.5	350	500	SOD-323
ESD5V0D3	5	10	6		9.8	350	350	
ESD8V0D3	8	10	8.5		13.4	350	150	
ESD12VD3	12	1	13.3		19	350	120	
ESD15VD3	15	1	16.7		24	350	100	
ESD24VD3	24	1	26.7		43	350	80	
ESD36VD3	36	1	40		60	350	30	

Part number	VRWM	IR (μA)	VBR (V)	IT(mA)	VC (V) @IPP=1A	Ppk	C	PACKAGE
	(V)	@ VRWM	@ IT			(W)	(pF)	

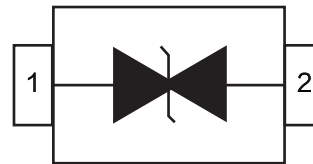

ESD3V3D3B	3.3	200	4	1	7	320	350	SOD-323
ESD5V0D3B	5	10	6		9.8	320	260	
ESD8V0D3B	8	5	8.5		13.4	320	120	
ESD12VD3B	12	1	13.3		19	320	110	
ESD15VD3B	15	1	16.7		24	320	100	
ESD24VD3B	24	1	26.7		43	320	75	
ESD36VD3B	36	1	40		60	320	35	

SOD323

Part number	VRWM	IR (μA)	VBR (V)	IT(mA)	VC (V)	Ppk	C	PACKAGE
	(V)	@ VRWM	@ IT		@IPP=1A			

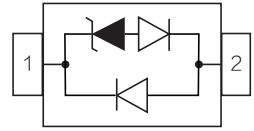

ESDLC3V3D3	3.3	40	4	1	5.15	350	1	SOD-323
ESDLC5V0D3	5	5	6		9.8	350	1	
ESDLC8V0D3	8	2	8.5		13.4	350	1	
ESDLC12VD3	12	1	13.3		19	350	1	
ESDLC15VD3	15	1	16.7		24	350	1	
ESDLC24VD3	24	1	26.7		43	350	1	

Part number	VRWM	IR (μA)	VBR (V)	IT(mA)	VC (V)	Ppk	C	PACKAGE
	(V)	@ VRWM	@ IT		@IPP=1A			

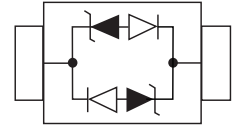

ESDLC3V3D3B	3.3	40	4	1	7.5	350	1	SOD-323
ESDLC5V0D3B	5	5	6		9.8	350	1	
ESDLC8V0D3B	8	2	8.5		13.4	350	1	
ESDLC12VD3B	12	1	13.3		19	350	1	
ESDLC15VD3B	15	1	16.7		24	350	1	
ESDLC24VD3B	24	1	26.7		43	350	1	

PACKAGE OUTLINE DIMENSIONS in millimeters (inches) :SOD323

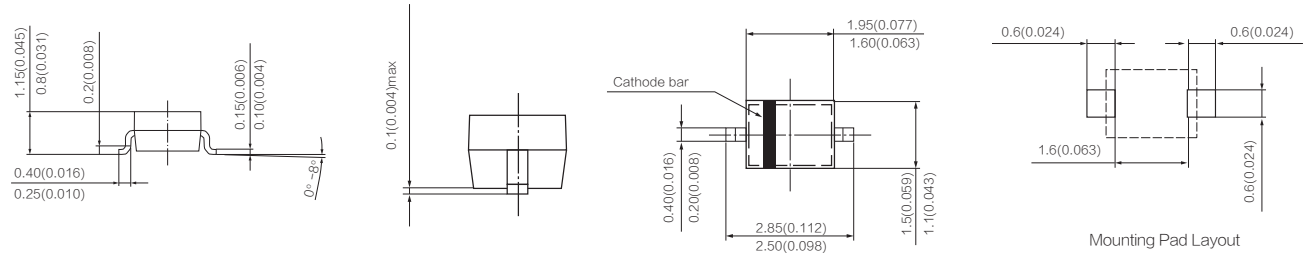

ESD

SOD523

Part number	VRWM	IR (μA)	VBR (V)	IT(mA)	VC (V) @IPP=1A	Ppk	C	PACKAGE
	(V)	@ VRWM	@ IT			(W)	(pF)	

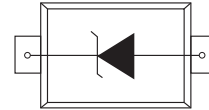

ESD3V3D5	3.3	1	4	1	7	200	105	SOD523
ESD5V0D5	5	1	6		9.8	200	25	
ESD8V0D5	8	5	8.5		13	200	70	
ESD12VD5	12	1	13.3		15	200	45	
ESD15VD5	15	1	16.6		21	200	50	
ESD24VD5	24	1	27		40	200	40	
ESDULC5V0D5	5	1	5.4		12.9	200	0.5	

Part number	VRWM	IR (μA)	VBR (V)	IT(mA)	VC (V) @IPP=1A	Ppk	C	PACKAGE
	(V)	@ VRWM	@ IT			(W)	(pF)	

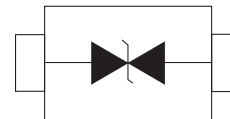

ESD3V3D5B	3.3	2.5	4	1	7	100	18	SOD523
ESD5V0D5B	5	1	6.2		9.8	200	80	
ESD8V0D5B	8	1	8.5		17.5	100	10	
ESDULC5V0D5B	5	1	6		12.9	200	0.5	

PACKAGE OUTLINE DIMENSIONS in millimeters (inches) :SOD523

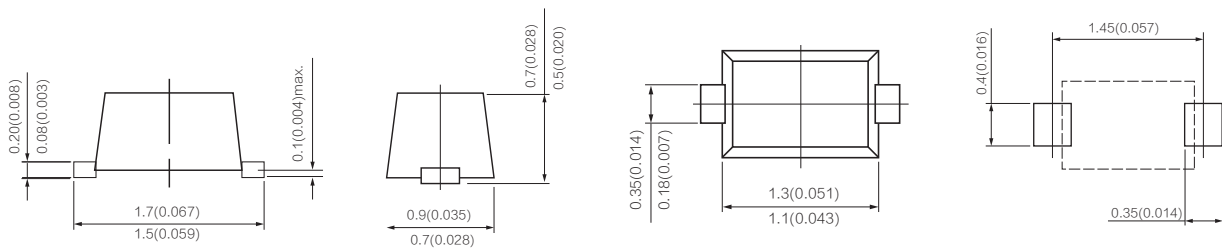

Mounting Pad Layout

SOD882

Part number	VRWM	IR (μA)	VBR (V)	IT(mA)	VC (V) @IPP=1A	Ppk	C	PACKAGE
	(V)	@ VRWM	@ IT			(W)	(pF)	

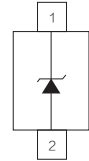

ESD3V3D8	3.3	2.5	5	1	10.4	102	80	SOD882
ESD5V0D8	5	1	6.2		12.3	107	65	
ESD12VD8	12	1	13.3		23.7	140	30	
ESD24VD8	24	1	26.7		36	100	25	
ESDULC3V3D8	3.3	1	4.8		12	60	0.5	
ESDULC5V0D8	5	1	5.4		9.8	120	0.5	

Part number	VRWM	IR (μA)	VBR (V)	IT(mA)	VC (V) @IPP=1A	Ppk	C	PACKAGE
	(V)	@ VRWM	@ IT			(W)	(pF)	

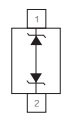

ESD3V3D8B	3.3	1	5	1	8.4	150	25	SOD882
ESD5V0D8B	5	1	5.6		11.6	100	15	
ESD12VD8B	12	1	13.3		18	72	9.5	
ESDLC5V0D8B	5	1	5.5		11.5	100	3.5	
ESDLC24VD8B	24	1	27		35	180	10	
ESDULC3V3D8B	3.3	1	4.8		10	150	0.5	
ESDULC5V0D8B	5	1	6		11	100	0.5	

PACKAGE OUTLINE DIMENSIONS in millimeters :SOD882

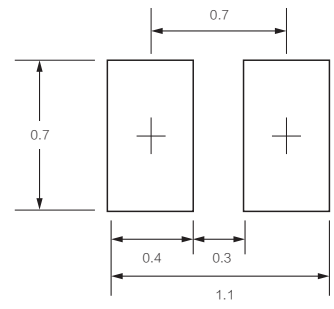
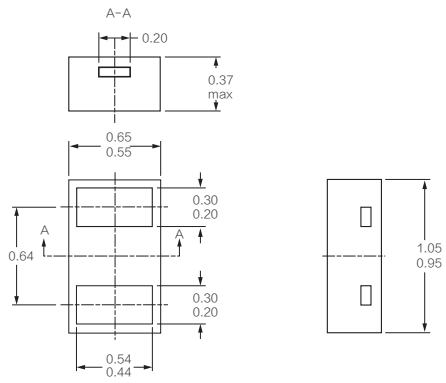

ESD

SOD923

Part number	VRWM	IR (μA)	VBR (V)	IT(mA)	VC (V) @IPP=1A	Ppk	C	PACKAGE
	(V)	@ VRWM	@ IT			(W)	(pF)	

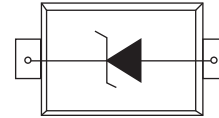

ESD3V3D9	3.3	2.5	5	1	6.5	88	45	SOD-923
ESD5V0D9	5	1	6.2		9.8	107	65	
ESD12VD9	12	1	13.5		23.7	140	30	
ESDULC3V3D9	3.3	1	4.8		12	50	0.5	
ESDULC5V0D9	5	1	5.4		9.8	50	0.5	

Part number	VRWM	IR (μA)	VBR (V)	IT(mA)	VC (V) @IPP=1A	Ppk	C	PACKAGE
	(V)	@ VRWM	@ IT			(W)	(pF)	

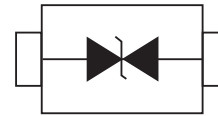

ESD3V3D9B	3.3	1	5.1	1	14.1	150	25	SOD-923
ESD5V0D9B	5	1	6		18.6	150	15	
ESD12V0D9B	12	1	13.8		30	150	14	
ESDULC3V3D9B	3.3	1	4.8		10	50	0.9	
ESDULC5V0D9B	5	1	5.4		12.9	50	0.9	

PACKAGE OUTLINE DIMENSIONS in millimeters (inches) :SOD923

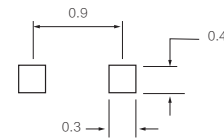
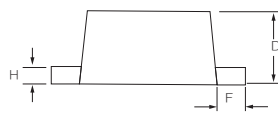
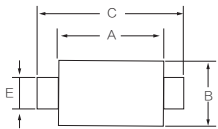

Mounting Pad Layout(mm)

Dim	Inches		Millimeters	
	MIN	MAX	MIN	MAX
A	0.030	0.033	0.75	0.85
B	0.022	0.026	0.55	0.65
C	0.037	0.041	0.95	1.05
D	0.014	0.017	0.36	0.43
E	0.006	0.010	0.15	0.25
F	0.002	0.006	0.05	0.15
H	0.003	0.007	0.07	0.17

SOT23

Part number	VRWM	IR (μA)	VBR (V)	IT(mA)	VC (V)	Ppk	C	PACKAGE
	(V)	@ VRWM	@ IT		@IPP=1A	(W)	(pF)	

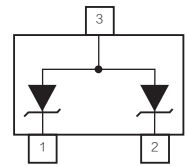

ESD3V3AP	3.3	10	5.9	1	9.3	300	120	SOT23
ESD5V0AP	5	10	6.2		9.8	300	110	
ESD8V0AP	8	5	8.5		16.9	300	250	
ESD12VAP	12	1	13.3		19	300	60	
ESD15VAP	15	1	16.7		30	300	100	
ESD24VAP	24	1	26.7		49	300	90	
ESD36VAP	36	1	40		76.8	300	75	

Part number	VRWM	IR (μA)	VBR (V)	IT(mA)	VC (V)	Ppk	C	PACKAGE
	(V)	@ VRWM	@ IT		@IPP=1A	(W)	(pF)	

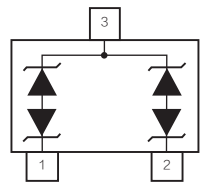

ESD3V3APB	3.3	40	4	1	10.5	350	220	SOT23
ESD5V0APB	5	1	6		12	300	80	
ESD8V0APB	8	1	8.5		24	350	75	
ESD12VAPB	12	1	13.3		30	300	35	
ESD15VAPB	15	1	16.7		38	350	60	
ESD24VAPB	24	1	27		45	300	25	
ESD36VAPB	36	1	38		60	300	20	
ESDLC5V0APB	5	1	5.8		10	50	15	

ESD

SOT23

Part number	VRWM	IR (μ A)	VBR (V)	IT(mA)	VC (V)	Ppk	C	PACKAGE
	(V)	@ VRWM	@ IT		@IPP=1A	(W)	(pF)	

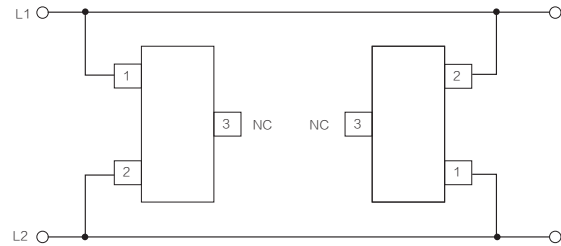
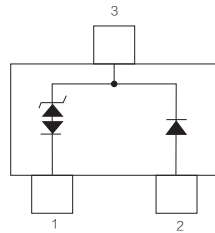

ESDSLJU2.8	2.8	1	3	1	15	400	2	SOT23
------------	-----	---	---	---	----	-----	---	-------

Part number	VRWM	IR (μ A)	VBR (V)	IT(mA)	VC (V)	Ppk	C	PACKAGE
	(V)	@ VRWM	@ IT		@IPP=1A	(W)	(pF)	

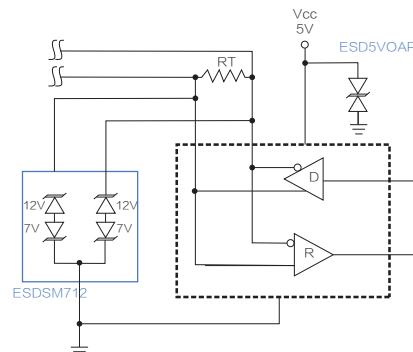
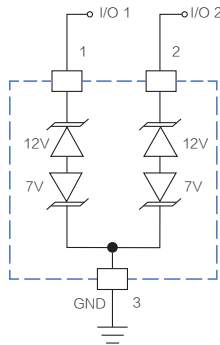

ESDSM712	Pin 1 or 2 to 3	12	1	13.3	1	26	400	45	SOT23
	Pin 3 to 1 or 2	7	20	7.5		12			

SOT23

Part number	VRWM	IR (μA)	VBR (V)	IT(mA)	VC (V) @IPP=1A	Ppk	C	PACKAGE
	(V)	@ VRWM	@ IT			(W)	(pF)	



SOT-23

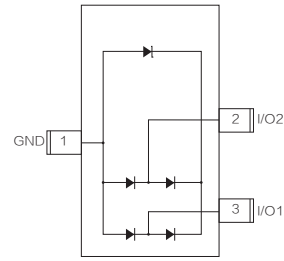

SOT-23-3L(Top view)

ESDSR05AP	5	1	6	1	8.5	150	1.2	SOT-23
-----------	---	---	---	---	-----	-----	-----	--------

PACKAGE OUTLINE DIMENSIONS in millimeters (inches) :SOT-23

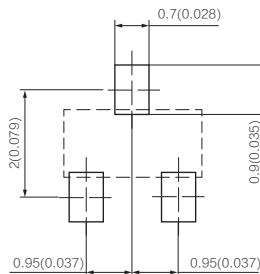
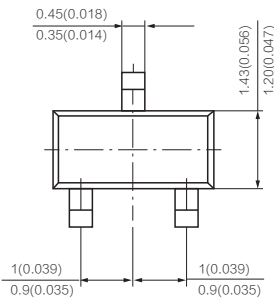
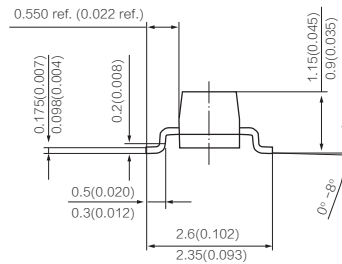
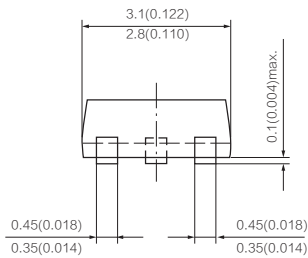

Mounting Pad Layout

ESD

DFN

Part number	VRWM	IR (μA)	VBR (V)	IT(mA)	VC (V)	Ppk	C	PACKAGE
	(V)	@ VRWM	@ IT		@ IPP=1A	(W)	(pF)	

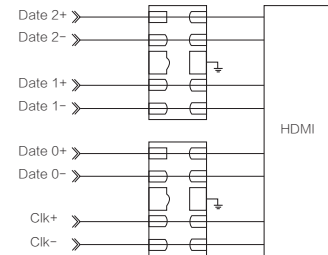
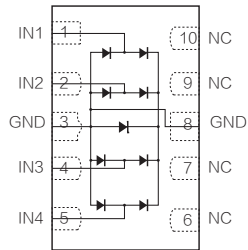

ESD0524P	5	1	6	1	8.5	150	0.35	DFN-10-2.5*1.0*0.6-0.5
----------	---	---	---	---	-----	-----	------	------------------------

DFN-10-2.5*1.0*0.6-0.5 (1)

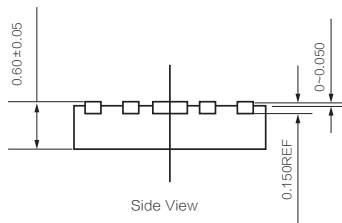
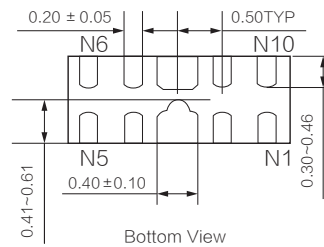
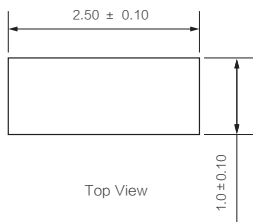

DFN

DFN-10-2.5*1.0*0.6-0.5 (2)

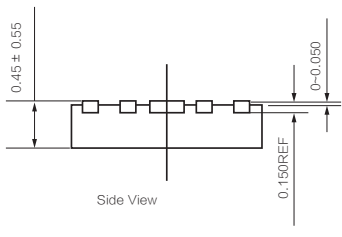
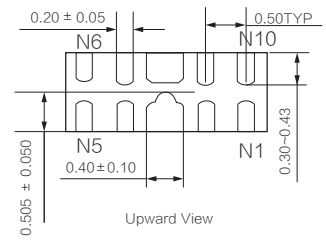
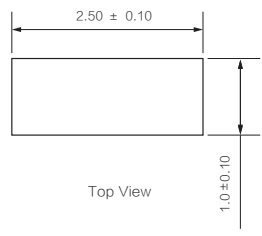

ESD

DFN

Part number	VRWM	IR (μA)	VBR (V)	IT(mA)	VC (V) @IPP=1A	Ppk	C	PACKAGE
	(V)	@ VRWM	@ IT			(W)	(pF)	



DFN-10-2.5X2.5X0.6-0.5



SOP-8-255-1.27

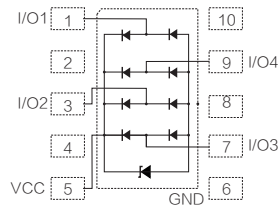

DFN-10-2.5X2.5X0.6-0.5(Top view)

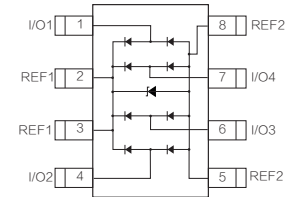

SOP-8-225-1.27(Top view)

ESD3304P	3.3	1	3.8	1	12	450	3.5	DFN-10-2.5*2.5*0.6-0.5
ESD3304S	3.3	1	3.8	1	12	450	3.5	SOP-8-225-1.27

DFN-10-2.5 × 2.5 × 0.6-0.5

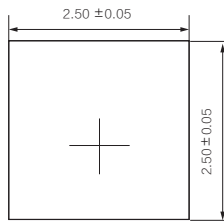

俯视图

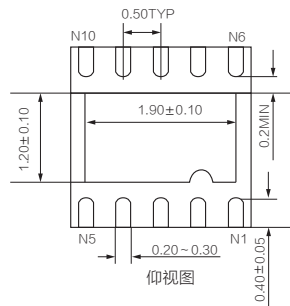

仰视图

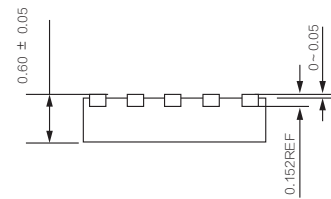

侧视图

SOP-8-225-1.27

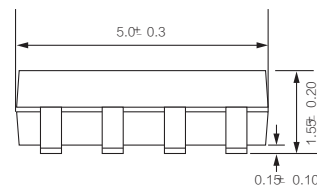
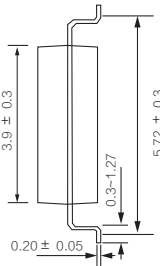
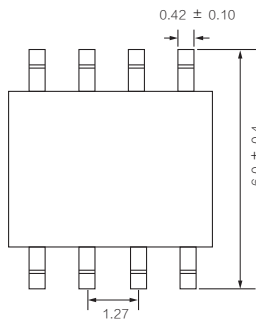

SOT-143

Part number	VRWM	IR (μA)	VBR (V)	IT(mA)	VC (V)	IPP	Ppk	C	PACKAGE
	(V)	@ VRWM	@ IT		@IPP=1A				

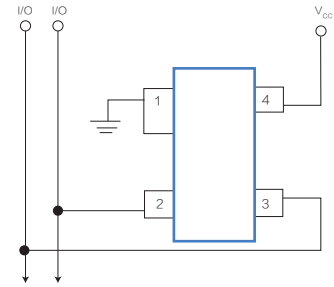
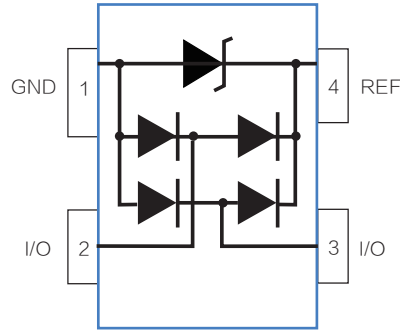

ESDSR05	5	5	6	1	9.8	12	500	2.5	SOT-143
---------	---	---	---	---	-----	----	-----	-----	---------

Part number	VRWM	IR (μA)	VBR (V)	IT(mA)	VC (V)	IPP	Ppk	C	PACKAGE
	(V)	@ VRWM	@ IT		@IPP=1A				

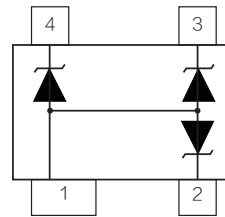

ESD5V0L3	5	5	6	1	9.8	12	100	30	SOT-143
----------	---	---	---	---	-----	----	-----	----	---------

ESD

SOT-143

Part number	VRWM	IR (μA)	VBR (V)	IT(mA)	VC (V)	IPP	Ppk	C	PACKAGE
	(V)	@ VRWM	@ IT		@IPP=1A	(A)	(W)	(pF)	

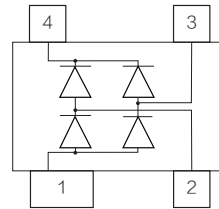

ESDSR70	70	5	85	50	1.5	24	/	3	SOT-143
---------	----	---	----	----	-----	----	---	---	---------

PACKAGE OUTLINE DIMENSIONS in inches (millimeters) SOT-143

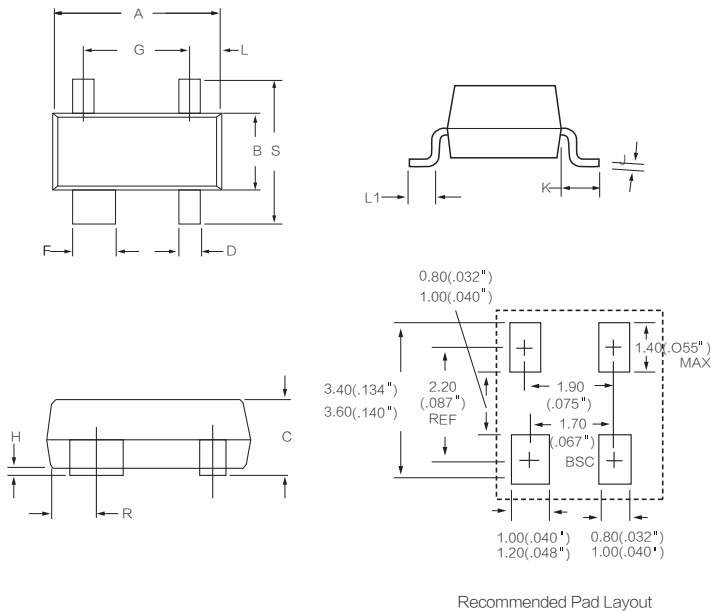

Dim	Inches		Millimeters	
	MIN	MAX	MIN	MAX
A	2.80	3.04	0.110	0.120
B	1.20	1.39	0.047	0.055
C	0.84	1.14	0.033	0.045
D	0.39	0.50	0.015	0.020
F	0.79	0.93	0.031	0.037
G	1.78	2.03	0.070	0.080
J	0.08	0.15	0.003	0.006
K	0.46	0.60	0.018	0.024
L	0.045	0.60	0.0175	0.024
L1	0.4	0.60	0.016	0.024
R	0.72	0.83	0.028	0.033
S	2.11	2.48	0.083	0.098

SOT23-6L

Part number	VRWM	IR (μA)	VBR (V)	IT(mA)	VC (V)	Ppk	C	PACKAGE
	(V)	@ VRWM	@ IT		@IPP=1A	(W)	(pF)	

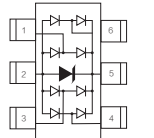

SOT-23 6L(Top view)

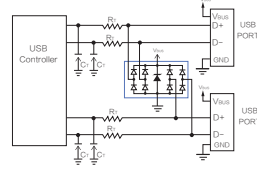

ESDSRV05-4	5	1	6	1	12.5	350	2.5	SOT23-6L
ESDSRVLC05-4	5	1	6	1	12.5	350	0.8	

PACKAGE OUTLINE DIMENSIONS in inches (millimeters) SOT23-6L

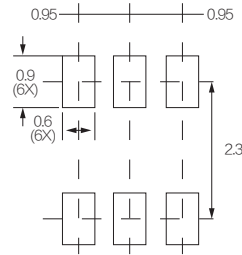
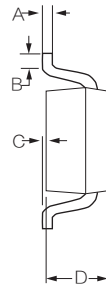
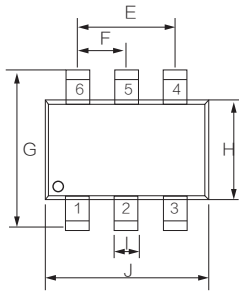

SYMBOL	DIMENSIONS			
	INCHES		MILLIMETERS	
	MIN	MAX	MIN	MAX
A	0.004	0.007	0.11	0.19
B	0.016	-	0.40	-
C	-	0.004	-	0.10
D	0.039	0.047	1.00	1.20
E	0.074	0.075	1.88	1.92
F	0.037	0.038	0.93	0.97
G	0.102	0.118	2.60	3.00
H	0.059	0.067	1.50	1.70
I	0.016	0.016	41	41
J	0.110	0.118	2.80	3.00

ESD

SOP-8

Part number	VRWM	IR (μA)	VBR (V)	IT(mA)	VC (V)	IPP	Ppk	C	PACKAGE
	(V)	@ VRWM	@ IT		@ IPP=1A	(A)	(W)	(pF)	

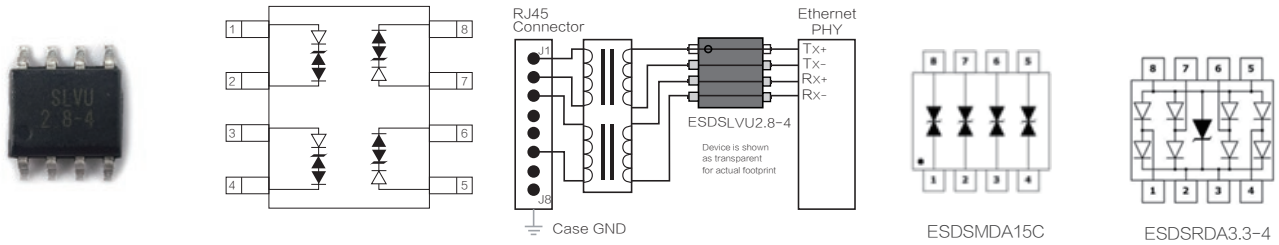

ESDSLVU2.8-4	2.8	1	3	1	5.5	24	400	3	SOP-8
ESDSMDA15C	15	1	16.7	1	30	5	500	80	
ESDSRDA3.3-4	3.3	40	4	1	15.5	27	500	5	

PACKAGE OUTLINE DIMENSIONS SOP-8

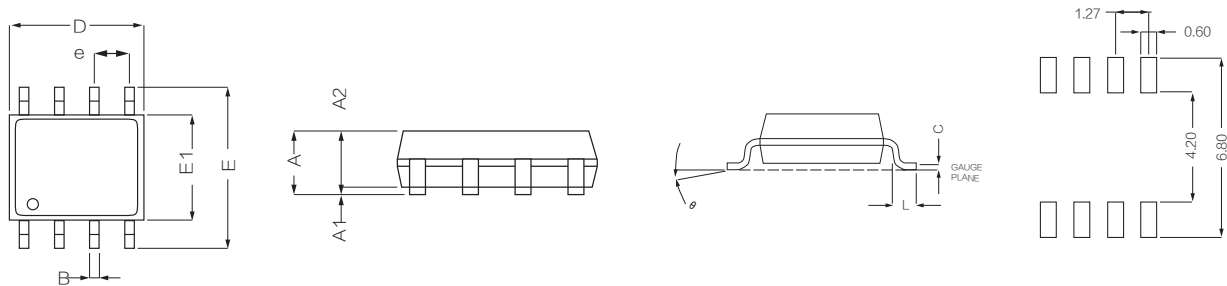

SYMBOL	DIMENSIONS			
	INCHES		MILLIMETERS	
	MIN	MAX	MIN	MAX
A	0.053	0.069	1.35	1.75
A1	0.004	0.010	0.10	0.25
A2	0.050	0.065	1.25	1.65
B	0.012	0.020	0.31	0.51
c	0.007	0.010	0.17	0.25
D	0.189	0.197	4.80	5.00
E	0.228	0.244	5.80	6.20
E1	0.150	0.157	3.80	4.00
e	0.050BSC		1.27BSC	
L	0.016	0.050	0.40	1.27

SOT-353

PACKAGE OUTLINE DIMENSIONS : SOT - 353

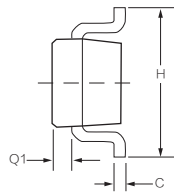
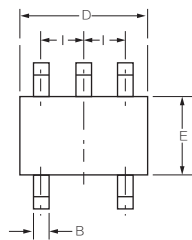
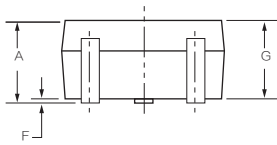

Dimension	MM (INCHES)	
	MAX	MIN
A	0.80 (0.031)	1.10 (0.043)
B	0.15 (0.006)	0.30 (0.012)
C	0.10 (0.004)	0.18 (0.007)
D	1.80 (0.071)	2.20 (0.087)
E	1.15 (0.045)	1.35 (0.053)
F		0.10 (0.004)
G	0.80 (0.031)	1.00 (0.039)
H	1.80 (0.071)	2.40 (0.094)
I		TYP: 0.65 (0.026)
Q1	0.10 (0.004)	0.40 (0.016)

Part number	VRWM	IR (μA)	VBR (V)	IT(mA)	VC (V) @IPP=1A	Ppk	C	PACKAGE
	(V)	@ VRWM	@ IT			(W)	(pF)	

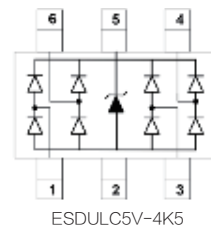
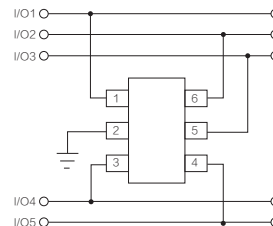
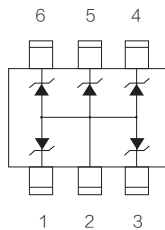

ESD5V0M5	5	5	6	1	12	60	30	SOT-563
ESD5V0K5	5	5	6	1	12	60	30	SOT-363
ESDULC5V-4K5	5	1	6	1	20	100	0.8	SOT-363

SOT-563

PACKAGE OUTLINE DIMENSIONS in millimeters (inches) :SOT-563

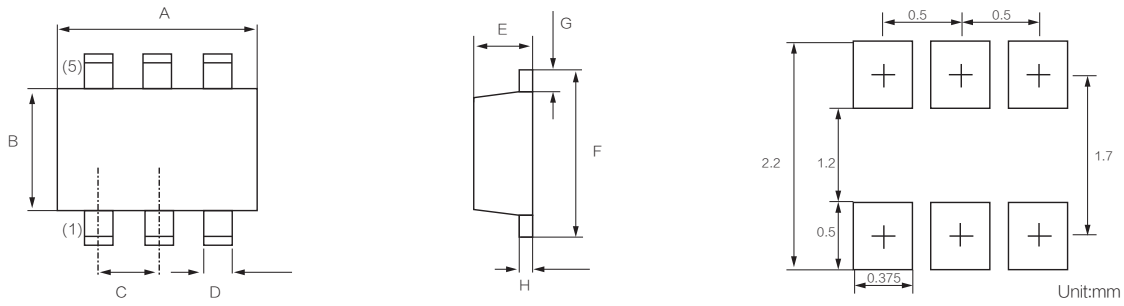

SYMBOL	DIMENSIONS			
	INCHES		MILLIMETERS	
	MIN	MAX	MIN	MAX
A	1.50	1.70	0.059	0.067
B	1.10	1.30	0.043	0.051
C	0.50BSC		0.020BSC	
D	0.17	0.27	0.007	0.011
E	0.50	0.60	0.020	0.024
F	1.50	1.70	0.059	0.067
G	0.10	0.30	0.004	0.012
H	0.08	0.16	0.003	0.006

SOT-363

PACKAGE OUTLINE DIMENSIONS : SOT-363

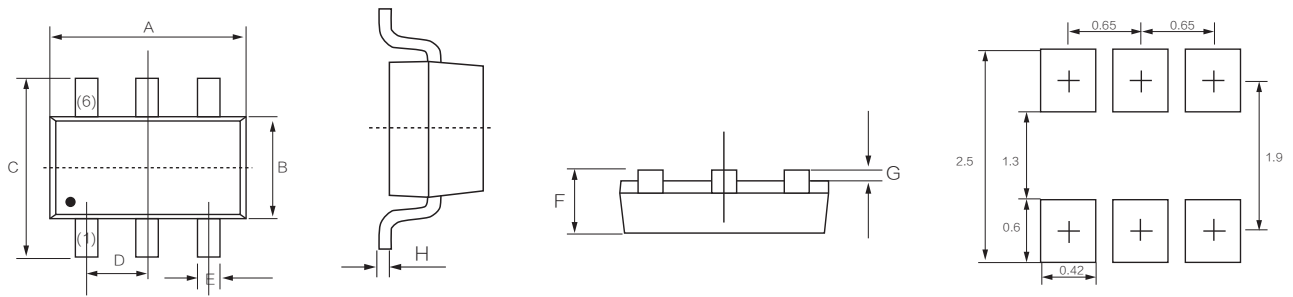

SYMBOL	DIMENSIONS			
	INCHES		MILLIMETERS	
	MIN	MAX	MIN	MAX
A	2.0	2.2	0.079	0.087
B	1.15	1.35	0.045	0.053
C	2.15	2.45	0.085	0.096
D	0.65BSC		0.026BSC	
E	0.15	0.35	0.006	0.014
F	0.90	1.10	0.035	0.043
G	0.00	0.10	0.000	0.004
H	0.08	0.15	0.003	0.006

ESD抑制器电容很小，可适用于高速信号电路(IEEE 1394, USB 2.0, HDMI, DVI, etc.)的保护，并且有单路和多路的封装，在提供ESD保护的同时，也可保证信号的完整性。

ESD Suppressors offer extremely low capacitance which makes them ideal for use in high-speed data circuits (IEEE 1394, USB 2.0, HDMI, DVI, etc.). Available in single-line and multi-line packages, they provide ESD protection while ensuring that signal integrity is maintained.

Part Number	Working Voltage DC	Clamping Voltage 8/20 μ S 1A	Reverse Leakage Current	Capacitance	IEC61000-4-2
	V	VC Max	I _R	@1MHZ	
				Ref.PF	
ESD040205P015	5.0	30	1	0.15	Contact :>8KV Air : >15KV
ESD040208P030	8.0	45	1	0.3	
ESD040212P060	12.0	50	1	0.6	
ESD040215P080	15.0	60	1	0.8	
ESD040218P080	18.0	65	1	0.8	
ESD040224P080	24.0	80	1	0.8	
ESD060305P015	5.0	30	1	0.15	
ESD060308P030	8.0	45	1	0.3	
ESD060312P060	12.0	50	1	0.6	
ESD060315P080	15.0	60	1	0.8	
ESD060318P080	18.0	65	1	0.8	
ESD060324P080	24.0	80	1	0.8	

- ▲ The application tolerates very little added capacitance (high speed data lines or RF circuits)
- ▲ ESD is the only transient threat
- ▲ Protection is required on data, signal, and control lines (not power supply lines)

单击下面可查看定价，库存，交付和生命周期等信息

[>>Yint\(音特电子\)](#)