



MTLT305D/M SERIES USER MANUAL

Document Part Number: 7430-3305-07



ACEINNA, Inc.

email: info@aceinna.com, website: www.aceinna.com

Date	Document Revision	Firmware Applicability	Description	Author
June 17, 2018	-01	V19.1.4	Initial Release	FL / JF
March 7, 2019	-02	V19.1.5	Update for new FW release. BIT Tables, theory of operation, and Appendix A (dbc File Example)	XD / JF
April 9, 2019	-03	V19.1.5	Add Recommended Mounting Hardware and torque specification. Removed dbc file appendix	JF
June 17, 2019	-04	V19.1.51	Correct RS232 Pinout Add CAN Data Message upper byte definition	JF
Sept 19, 2019	-05	V19.1.51	Updated description of status information reported on CAN bus	AB
Nov 12, 2019	-06	V 19.1.6	Added requests for retrieval of specific data messages and parameters on demand from unit on CAN bus	AB
Mar, 1, 2020	-07		Added Metal Housing (M) version mechanical drawing. Changed all reference of MTLT305D to MTLT305D/M. Removed references to nonexistent appendices	JF

⚠ WARNING

Aceinna has developed this product exclusively for commercial applications. It has not been tested for, and Aceinna makes no representation or warranty as to conformance with, any military specifications or that the product is appropriate for any military application or end-use. Additionally, any use of this product for nuclear, chemical, biological weapons, or weapons research, or for any use in missiles, rockets, and/or UAV's of 300km or greater range, or any other activity prohibited by the Export Administration Regulations, is expressly prohibited without the written consent of Aceinna and without obtaining appropriate, US export license(s) when required by US law. Diversion contrary to U.S. law is prohibited.

©2018 Aceinna, Inc. All rights reserved. Information in this document is subject to change without notice.

Aceinna is a registered trademark of Aceinna Inc. Other product and trade names are trademarks or registered trademarks of their respective holders.



Table of Contents

1 Introduction 5

 1.1 Manual Overview 5

 1.2 Overview of the MTLT305D/M Dynamic Inclination and Acceleration Sensor 6

2 Interface 7

 2.1 Electrical Interface..... 7

 2.1.1 Connector and Mating Connector 7

 2.1.2 Power Input and Power Input Ground..... 8

 2.1.3 CAN Serial Interface..... 8

 2.1.4 RS232 Serial Data Interface 8

 2.2 Mechanical Interface 9

 2.2.1 Recommended Mounting Hardware and Torque 9

3 Theory of Operation 10

 3.1 MTLT305D/M Series Default Coordinate System 13

 3.1.1 Axis Orientation Settings 14

 3.2 Digital Filter 14

 3.2.1 Acceleration Filter Settings 14

 3.2.2 Rate Sensor Filter Settings 14

4 CAN Port Interface Definition..... 15

 4.1 SAEJ1939..... 15

 4.1.1 ECU's Address..... 16

 4.1.2 Address Claim..... 16

 4.1.3 Baud Rate 16

 4.1.4 Get Commands..... 16

 4.1.5 Set Commands 24

 4.1.6 Data Packets 30

 4.2 DBC File..... 31

5 RS232 Port Interface Definition 32

 5.1 General Settings..... 32

 5.2 Number Formats 32

 5.3 Packet Format..... 33

 5.3.1 Packet Header..... 33

 5.3.2 Packet Type 33

 5.3.3 Payload Length..... 34



5.3.4	Payload.....	34
5.3.5	16-bit CRC-CCITT	34
5.3.6	Messaging Overview.....	34
6	MTLT305D/M Standard RS232 Port Commands and Messages.....	36
6.1	Link Test.....	36
6.1.1	Ping Command.....	36
6.1.2	Ping Response	36
6.1.3	Echo Command.....	36
6.1.4	Echo Response	36
6.2	Interactive Commands.....	36
6.2.1	Get Packet Request	37
6.2.2	Algorithm Reset Command.....	37
6.2.3	Algorithm Reset Response	37
6.2.4	Error Response	37
6.3	Output Packets (Polled).....	38
6.3.1	Identification Data Packet	38
6.3.2	Version Data Packet.....	38
6.3.3	Test 0 (Detailed BIT and Status) Packet	39
6.4	RS232 Output Packets (Polled or Continuous)	39
6.4.1	Angle Data Packet 2 (Default MTLT305D/M Data)	39
7	MTLT305D/M Advanced RS232 Port Commands	41
7.1	Configuration Fields.....	41
7.2	Continuous Packet Type Field.....	42
7.3	Digital Filter Settings	42
7.4	Orientation Field.....	42
7.5	User Behavior Switches	43
7.6	Commands to Program Configuration Over RS232.....	44
7.6.1	Write Fields Command	44
7.6.2	Set Fields Command	45
7.7	Read Fields Command	46
7.8	Read Fields Response.....	46
7.9	Get Fields Command.....	47
7.10	Get Fields Response.....	47
8	Bootloader	49



8.1	Bootloader Initialization.....	49
8.2	Firmware Upgrade Command.....	49
8.2.1	UART Interface.....	49
9	Warranty and Support Information.....	51
9.1	Customer Service.....	51
9.2	Contact Directory.....	51
9.3	Return Procedure.....	51
9.3.1	Authorization.....	51
9.3.2	Identification and Protection.....	51
9.3.3	Sealing the Container.....	52
9.3.4	Marking.....	52
	Appendix A: Installation and Operation of NAV-VIEW over RS232.....	53
	Appendix B: Sample RS232 Packet-Parser Code.....	65
	Appendix C: RS232 Sample Packet Decoding.....	73
	Appendix D: Advanced RS232 Port BIT.....	74

About this Manual

The following annotations have been used to provide additional information.

◀ NOTE

Note provides additional information about the topic.

☑ EXAMPLE

Examples are given throughout the manual to help the reader understand the terminology.

⚡ IMPORTANT

This symbol defines items that have significant meaning to the user

⚠ WARNING

The user should pay particular attention to this symbol. It means there is a chance that physical harm could happen to either the person or the equipment.

The following paragraph heading formatting is used in this manual:

1 Heading 1

1.1 Heading 2

1.1.1 Heading 3

1.1.1.1 Heading 4

Normal



1 Introduction

1.1 Manual Overview

This manual provides a comprehensive introduction to ACEINNA's MTLT305D/M Series Dynamic Inclination and Acceleration Sensing Family of products. As the functionality of the different products within the family are identical (only the performance specs are different), for simplicity all references will be to the MTLT305D/M. For users wishing to get started quickly, please refer to the two-page Best Practices Guide available online at www.aceinna.com. Table 1 highlights the content in each section and suggests how to use this manual.

Table 1 Manual Content

Manual Section	Who Should Read?
Section 1: Overview	All customers should read sections 1.1 and 1.2.
Section 2: Interface	Customers designing the electrical and mechanical interface to the MTLT305D/M series products should read Section 2.
Section 3: Theory of Operation	All customers should read Section 3.
Section 4 CAN Port Interface	Customers designing the software interface to the MTLT305D/M series products CAN Port should review Section 4
Section 0 - 7: RS232 Port Interface	Customers designing the software interface to the MTLT305D/M series products RS232 Port should review Sections 0 - 7.
Section 8: Bootloader	Customers upgrading firmware should review Sections 8.
Section 9: Warranty and Support	Customers who need the support information should review Section 9.



1.2 Overview of the MTLT305D/M Dynamic Inclination and Acceleration Sensor

This manual introduces the use of ACEINNA's MTLT305D/M Series Dynamic Inclination and Acceleration Sensing products listed in Table 2. This manual is intended to be used as a detailed technical reference and operating guide. ACEINNA's MTLT305D/M Series products combine the latest in high-performance commercial MEMS (Micro-electromechanical Systems) sensors and digital signal processing techniques to provide a small, rugged and cost effective solution for accurately sensing pitch and roll in dynamic applications.

Table 2 MTLT305D/M Series Feature Description

Product	Features
MTLT305D/M	Pitch, Roll, 3D ± 8 g acceleration, 3D ± 400 deg/s Bias Corrected Rate

The MTLT305D/M Series is based on ACEINNA's fourth generation of MEMS-based Inertial Systems, building on over a decade of field experience, and encompassing thousands of deployed units and millions of operational hours in a wide range of land, marine, airborne, and instrumentation applications.

At the core of the MTLT305D/M Series is a rugged 6-DOF (Degrees of Freedom) MEMS inertial sensor cluster that is common across all members of the MTLT305D/M Series and many ACEINNA IMU, AHRS and INS products. The 6-DOF MEMS inertial sensor cluster includes three axes of MEMS angular rate sensing and three axes of MEMS linear acceleration sensing. These sensors are based on rugged, field proven silicon micromachining technology. Each sensor within the cluster is individually factory calibrated for temperature and non-linearity effects during ACEINNA's manufacturing and test process using automated thermal chambers and precision rate tables.

Coupled to the 6-DOF MEMS inertial sensor cluster is a high performance microprocessor that utilizes the inertial sensor measurements to accurately compute attitude (pitch and roll). The attitude algorithm utilizes a multi-state Extended Kalman Filter (EKF) to correct for drift errors and estimate sensor bias values.

Another unique feature of the MTLT305D/M Series is the extensive field configurability of the units. This field configurability allows the MTLT305D/M Series of Inertial Systems to satisfy a wide range of applications and performance requirements with a single mass produced hardware platform. Parameters that can be configured include baud rate, low pass filter settings (acceleration and rate sensors) packet type, update rate, and defining of custom orientation.

The MTLT305D/M firmware is designed to be field upgradable so units in the field can be upgraded to take advantage of new features or algorithm improvements that may be available in future firmware revision releases.

The MTLT305D/M Series is available packaged cast metal housing or in a light-weight, rugged, IP69K sealed plastic enclosure with nickel plated brass mounting bushings designed for cost-sensitive commercial applications requiring a robust solution that can be exposed to the elements. Mounting configuration is the same for both versions. The MTLT305D/M can be configured to output data over a CAN Port and / or a RS232 serial port. The MTLT305D/M RS232 output data port is supported by ACEINNA's NAV-VIEW 3.X, a powerful PC-based operating tool that provides complete field configuration, diagnostics, charting of sensor performance, and data logging with playback.

2 Interface

2.1 Electrical Interface

2.1.1 Connector and Mating Connector

The MTLT305D/M connector is an AMPSEAL16 6-pos defined in Figure 1

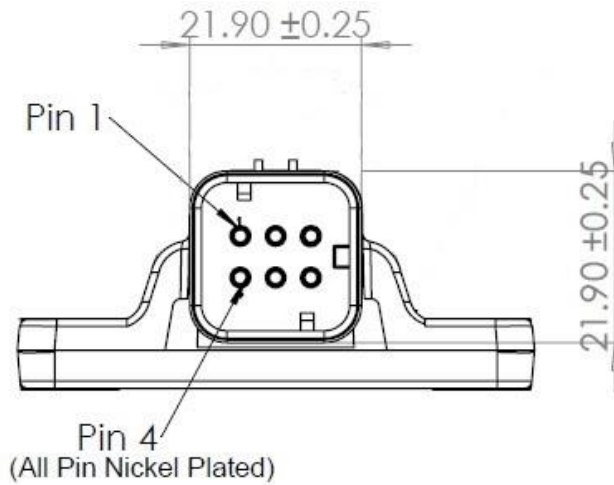

Figure 1 MTLT305D/M Interface Connector

The mating connector is: TE Connectivity 776531-1 or equivalent, which is currently listed at the following web address: <http://www.te.com/usa-en/product-776531-1.html>



The definitions of connector pins are in Table 3.

Table 3 MTLT305D/M Interface Connector Pin Definition

Pin	Signal
1	CAN H
2	CAN L
3	Ground
4	RS232 RX
5	RS232 TX
6	Power

2.1.2 Power Input and Power Input Ground

Power is applied to the MTLT305D/M on pin 6, and ground is Pin 3; The MTLT305D/M accepts an unregulated 5 to 32 VDC input. It is reverse polarity and ESD protected internally. It is designed to be compatible with 12 V and 24 V power environments of Heavy Equipment and Passenger Vehicle power systems.

2.1.3 CAN Serial Interface

The MTLT305D/M is equipped with a CAN 2.0 electrical interface and is compliant to the SAE J1939 protocol standard. CAN 120 ohm termination resistor is by default disabled. For systems requiring 120 CAN termination be present in the MTLT305D/M, it can be enabled and permanently saved through the RS232 port.

Baud Rate: The default CAN baud rate setting is 250kb/s. The MTLT305D/M can support up to 500kb/s baud rate. The CAN baud rate can be changed and permanently saved by the user using the RS232 port and NAV-VIEW 3.x SW running on a PC. See the section 4.1.3.

CAN Address: The default CAN address is 0x80. The MTLT305D/M has address claiming capability. In the event there is a conflict with another module on the bus with the same address, it will attempt to claim a new address and save it in non-volatile memory. The CAN address can also be changed and permanently saved by the user using the RS232 port and NAV-VIEW 3.x SW running on a PC. See the section 4.1.1.

2.1.4 RS232 Serial Data Interface

The default baud rate of RS232 interface is 57600bps. MTLT305D/M also supports 38400, 115200 and 230400bps baud rates and can be changed or saved permanently in non-volatile memory through NAV-VIEW.

The RS-232 standard defines the voltage levels that correspond to logical one and logical zero levels for the data transmission and the control signal lines. Valid signals are either in the range of +3 to +15 volts or the range -3 to -15 volts with respect to the "Common Ground" (GND) pin.

A "3-wire" RS-232 connection consisting only of transmit data, receive data, and ground, is commonly used.

2.2 Mechanical Interface

The MTLT305D/M mechanical interfaces are defined by the outline drawings in Figure 2.

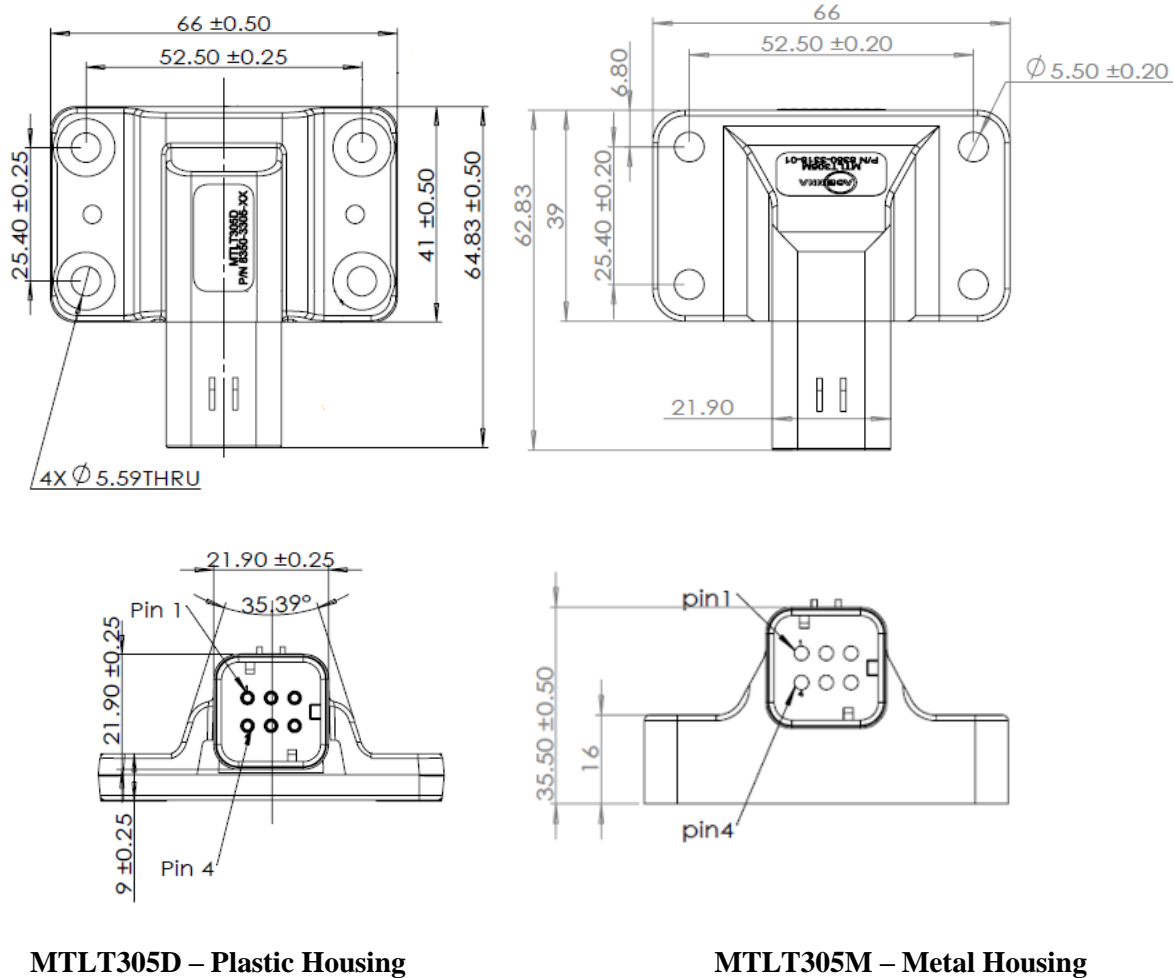

MTLT305D – Plastic Housing

MTLT305M – Metal Housing

Figure 2 MTLT305D/M Outline Drawing

Mating Connector: TE Connectivity 776531-1 or equivalent. See Figure 1

2.2.1 Recommended Mounting Hardware and Torque

Use 4 - M5 Alloy Steel Socket Head Screws to secure the MTLT305D/M.

It is recommended to use standard M5 washer with outer diameter of 10mm, lock washer and Loctite 242 thread lock.

The washer outer diameter must NOT be larger than the outer diameter of the bushing (11mm).

MTLT305D – Plastic Housing: Torque the screws to 2.37 N-m (21 inch-pounds).

MTLT305M – Metal Housing: Torque the screws to 5.0 N-m (44.25 inch-pounds).

3 Theory of Operation

The MTLT305D/M Series are a family of dynamic inclination and acceleration sensors. They provide dynamic pitch and roll, 3D linear acceleration, and 3D estimated rate measurement data (Pitch and Roll rates are bias corrected, Yaw is not).

Figure 3 shows the MTLT305D/M Series hardware block diagram. At the core of the MTLT305D/M Series is a rugged 6-DOF (Degrees of Freedom) MEMS inertial sensor cluster that is common across all members of the MTLT305D/M Series. The 6-DOF MEMS inertial sensor cluster includes three axes of MEMS angular rate sensing and three axes of MEMS linear acceleration sensing. These sensors are based on rugged, field proven silicon micromachining technology. Each sensor within the cluster is individually factory calibrated using ACEINNA's automated manufacturing process. Sensor errors compensated for are temperature bias, scale factor, non-linearity and misalignment effects using a proprietary algorithm from data collected during manufacturing. Accelerometer and rate gyro sensor bias shifts over temperature (-40 °C to +85 °C) are compensated and verified using calibrated thermal chambers and precision rate tables.

The acceleration sensors have a full-scale range (FSR) of $\pm 78 \text{ ms}^{-2}$, and the rate sensors have a FSR of 400 degrees/s. The large FSR ensures that the sensors are not over-ranged in the application. Both the acceleration and rate sensors are over sampled at 800 Hz, and digitally processed through a 3rd order 50 Hz low-pass filter (LPF), which serves as a digital anti-aliasing filter as the cutoff frequency is half of the maximum output data rate of 100 Hz. It is not user configurable. Additionally, the over sampling and primary LPF combine to eliminate higher frequency vibration and impulse energy providing greater accuracy in high-vibration environments.

The 50 Hz filtered data is then corrected for temperature related errors and non-linearity by ACEINNA's proprietary compensation algorithm using data collected during ACEINNA's calibration process.

The corrected data is then presented to the user configurable LPFs. The acceleration and rate sensors' LPFs can be set independently. The default setting for the rate data is 25 Hz and the default setting for the acceleration data is 5 Hz.

This dataset is used to generate the dynamic roll and pitch estimation and are stabilized by the using the accelerometers as a long-term gravity reference. Internally, the algorithm solves for roll and pitch at a 200 Hz rate, enabling the MTLT305D/M to continuously maintain the dynamic roll and pitch data as well as the 3D linear acceleration and 3D estimated rate data. The Yaw estimation (RS232 only) is a free integrating yaw angle measurement that is not stabilized by a magnetometer or compass heading. As shown in the software block diagram Figure 4, after the Sensor Calibration block, the temperature corrected and filtered data is passed into Integration to Orientation block. The Integration to Orientation block integrates body frame sensed angular rate to orientation at a fixed 200 times per second within the MTLT305D/M Series products. For improved accuracy and to avoid singularities when dealing with the Euler angles, a quaternion formulation is used in the algorithm to provide attitude propagation.

As also shown in the software block diagram, the Integration to Orientation block receives drift corrections from the Extended Kalman Filter (EKF) or Drift Correction Module. In general, rate sensors and accelerometers suffer from bias drift, misalignment errors, acceleration errors (g-sensitivity), nonlinearity (square terms), and scale factor errors. The largest error in the orientation propagation is associated with the rate sensor bias terms. The EKF module provides an on-the-fly calibration for drift errors, including the rate sensor bias, by providing corrections to the Integration to Orientation block and a characterization of the gyro bias state. In the MTLT305D/M, the internally computed gravity reference vector provides a reference measurement for the EKF when the MTLT305D/M is in quasi-static motion to correct roll and pitch angle drift and to estimate the X and Y gyro rate bias. Because the gravity vector has no horizontal component, the EKF has no ability to estimate either the yaw angle error or the Z gyro

rate bias. The MTLT305D/M adaptively tunes the EKF feedback in order to best balance the bias estimation and attitude correction with distortion free performance during dynamics when the object is accelerating either linearly (speed changes) or centripetally (false gravity forces from turns). Because centripetal and other dynamic accelerations are often associated with yaw rate, the MTLT305D/M maintains a low-passed filtered yaw rate signal and compares it to the turnSwitch threshold field (user adjustable). When the user platform to which the MTLT305D/M is attached exceeds the turnSwitch threshold yaw rate, the MTLT305D/M lowers the feedback gains from the accelerometers to allow the attitude estimate to coast through the dynamic situation with primary reliance on angular rate sensors. This situation is indicated by the softwareStatus → turnSwitch status flag. Using the turn switch maintains better attitude accuracy during short-term dynamic situations, but care must be taken to ensure that the duty cycle of the turn switch generally stays below 10% during the vehicle mission. A high turn switch duty cycle does not allow the system to apply enough rate sensor bias correction and could allow the attitude estimate to become unstable.

The MTLT305D/M algorithm has two major phases of operation. The first phase of operation is the initialization phase. During the initialization phase, the MTLT305D/M is expected to be stationary or quasi-static in order to get a good initial estimation of the roll and pitch angles, and X, Y rate sensor bias. The initialization phase lasts less than 2 seconds, and the initialization phase can be monitored in the softwareStatus BIT transmitted by default in each RS232 measurement packet. After the initialization phase, the MTLT305D/M operates in the dynamic mode to continuously estimate and correct for roll and pitch errors, as well as to estimate X and Y rate sensor bias.

If a user wants to reset the algorithm or re-enter the initialization phase, sending the algorithm reset command, 'AR', will force the algorithm into the reset phase.

The MTLT305D/M outputs digital measurement data over the CAN or RS232 port at a selectable fixed rate (100, 50, 25, 20, 10, 5 or 2 Hz) or on as requested basis.

In addition to the configurable baud rate, packet rate, axis orientation, and sensor low-pass filter settings, the MTLT305D/M provides additional advanced settings, which are selectable for tailoring the MTLT305D/M to a specific application requirement.

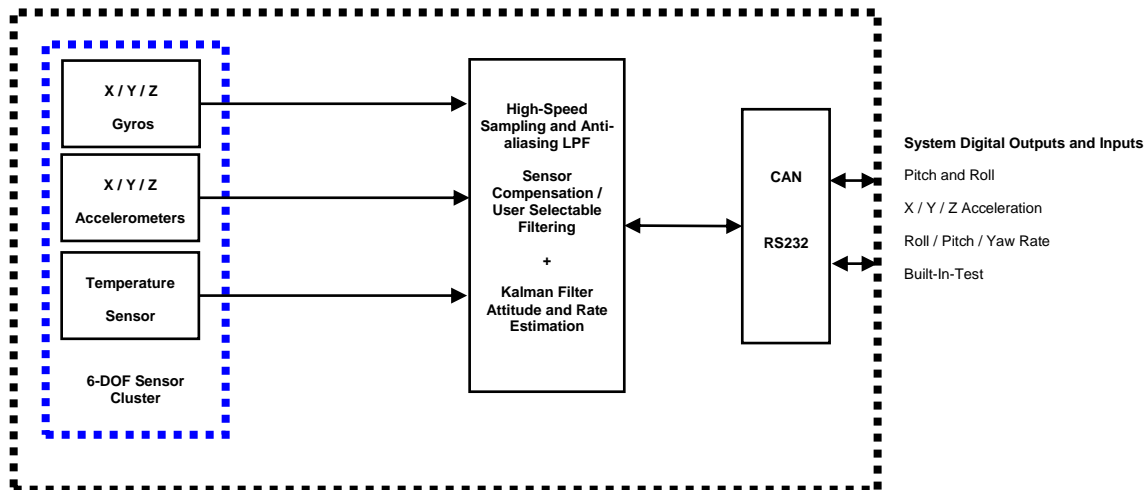

Figure 3 MTLT305D/M Series Hardware Block Diagram

Figure 4 shows the software block diagram. As shown in the software block diagram, the MTLT305D/M Series has a unit setting and profile block which configures the algorithm to user and application specific needs. This feature is one of the more powerful features in the MTLT305D/M Series architecture as it allows the MTLT305D/M Series to work in a wide range of commercial applications by settings different modes of operation for the MTLT305D/M Series.

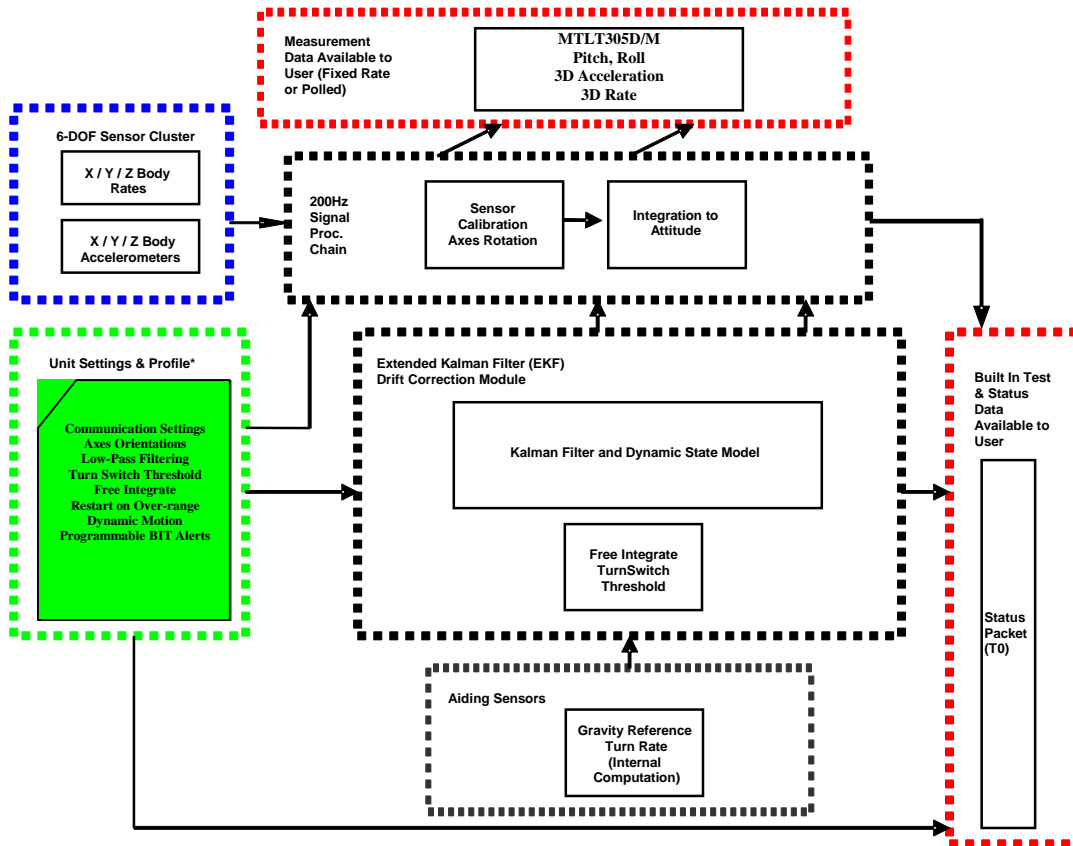

Figure 4 MTLT305D/M Series Software Block Diagram

The common aiding sensor for the drift correction for the attitude (i.e., roll and pitch only) is a 3-axis accelerometer. This is the default configuration for the MTLT305D/M products.

3.1 MTLT305D/M Series Default Coordinate System

The MTLT305D/M Series Inertial System default coordinate systems are shown in Figure 5. As with many elements of the MTLT305D/M Series, the coordinate system is configurable with either NAV-VIEW or by sending the appropriate serial commands over the CAN or RS232 port. These configurable elements are known as *Advanced Settings*. This section of the manual describes the default coordinate system settings of the MTLT305D/M Series when it leaves the factory.

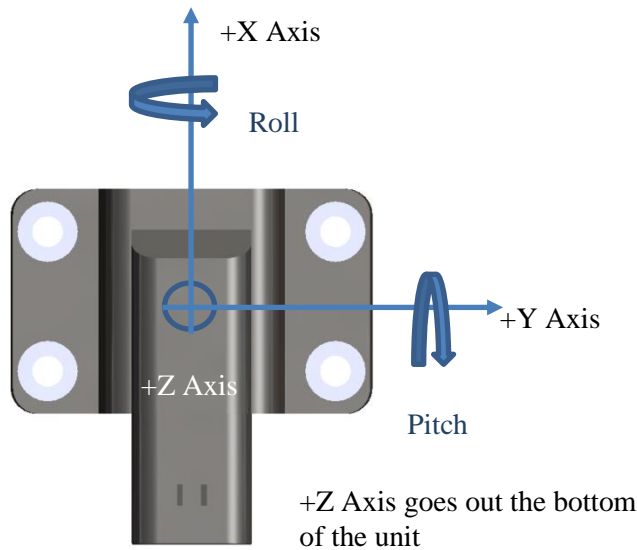

Figure 5. MTLT305D/M Default Coordinate Frame

The axes form an orthogonal SAE right-handed coordinate system. Acceleration is positive when it is oriented towards the positive side of the coordinate axis. For example, with a MTLT305D/M Series product sitting on a level table, it will measure zero g along the x and y-axes and -1 g along the z-axis. Normal Force acceleration is directed upward, and thus will be defined as negative for the MTLT305D/M Series z-axis.

The angular rate sensors are aligned with these same axes. The rate sensors measure angular rotation rate around a given axis. The rate measurements are labeled by the appropriate axis. The direction of a positive rotation is defined by the right-hand rule. With the thumb of your right hand pointing along the axis in a positive direction, your fingers curl around in the positive rotation direction. For example, if the MTLT305D/M Series product is sitting on a level surface and you rotate it clockwise on that surface, this will be a positive rotation around the z-axis. The x and y-axis rate sensors would measure zero angular rates, and the z-axis sensor would measure a positive angular rate.

Pitch is defined positive for a positive rotation around the y-axis (pitch up). Roll is defined as positive for a positive rotation around the x-axis (roll right). Yaw is defined as positive for a positive rotation around the z-axis (turn right).

“The angles are defined as standard Euler angles using a 3-2-1 system. To rotate from the earth-level frame to the body frame, yaw first, then pitch, and then roll.

3.1.1 Axis Orientation Settings

The MTLT305D/M gives users the ability to set the axes orientation by selecting which axis aligns with the base axes as well as the sign. The only constraint is the axes must conform to a right-hand definition. The available settings are described in Section 7.4. The specific selections are provided in Table 43. The default setting is (+Ux, +Uy, +Uz).

Refer to CAN Protocol Section 4.1.5.6 for instructions on changing the orientation for your application over the CAN bus.

Refer to RS232 Protocol Section 7.4 for instructions on changing the orientation for your application over the RS232 Port.

3.2 Digital Filter

There are two Independent User filters available for filtering the accelerometer and the rate-sensor signals. The Filters are 2nd order Butterworth filters that can be set to 50, 40, 25, 20, 10, 5, and 2 Hz cutoff frequencies. One setting applies to all three of a sensor's axes.

Acceleration sensor Filter default is 5 Hz. Rate Sensor default is 25 Hz.

3.2.1 Acceleration Filter Settings

Decreasing the accelerometer filter cutoff frequency will reduce transmission of the accelerometer noise to the algorithm and enable the system to better estimate roll and pitch angles (as well as rate-sensor bias) under noisy idle-conditions (such as vibration caused by engine noise). The filter will not have a large effect on the estimate of the roll and pitch angles during motion, as the role of the accelerometer is reduced during motion and angles are estimated by integrating the rate-sensor signal.

Refer to CAN Protocol Section 4.1.5.5 for instructions on changing the acceleration sensor filter for your application over the CAN bus.

Refer to RS232 Protocol Section 7.3 for instructions on changing the acceleration sensor filter for your application over the RS232 Port

3.2.2 Rate Sensor Filter Settings

Decreasing the rate-sensor filter cutoff frequency will reduce transmission of the vibrational noise to the algorithm and enable the system to generate less noisy roll and pitch angle estimates under noisy conditions (such as vibration caused by engine noise). However, very low cutoff frequency settings can increase lag in the signal, which may affect system performance. Settings must be made based on system requirements.

Refer to CAN Protocol Section 4.1.5.5 for instructions on changing the rate sensor filter setting for your application over the CAN bus.

Refer to RS232 Protocol Section 7.3 for instructions on changing the rate sensor filter for your application over the RS232Port

◀ NOTE on Filter Settings

Why change the filter settings? Generally, there is no reason to change the low-pass filter settings on the MTLT305D/M Series Inertial Systems. However, when a MTLT305D/M Series product is installed in an environment with a lot of vibration, it can be helpful to reduce the vibration-based signal energy and noise prior to further processing on the signal. Installing the MTLT305D/M in the target environment and reviewing the data with NAV-VIEW can be helpful to determine if changing the filter settings would be helpful. Although the filter settings can be helpful in reducing vibration based noise in the signal, low

filter settings (e.g., <5Hz) also reduce the bandwidth of the signal, i.e. can wash out the signals containing the dynamics of a target. Treat the filter settings with caution.

4 CAN Port Interface Definition

The CAN interface of MTLT supports the CAN protocol versions 2.0B. It has been designed to manage high numbers of incoming messages efficiently, and meets the priority requirements for transmit message.

MTLT305D/M supports a maximum baud rate 500Kbps. The default setting is 250kbs.

MTLT305D/M default configuration includes no CAN termination. 120 Ohm termination can be enabled and saved permanently through the RS232 port.

4.1 SAEJ1939

MTLT supports CAN's higher layer protocol, SAEJ1939, managing the communication within network. J1939 is a set of standards defined by SAE. The physical layer (J1939/11) describes the electrical interface to the bus. The data link layer (J1939/21) describes the rules for constructing a message, accessing the bus, and detecting transmission errors. The application layer (J1939/71 and J1939/73) defines the specific data contained within each message sent across the network.

J1939 uses the 29-bit identifier defined within the CAN 2.0B protocol shown in Table 5.

Table 4. Structure of a 29-bit identifier

Priority	Reserved	Data Page	PDU Format	PDU Specific	Source Address
3 bits	1 bits	1bit	8 bits	8 bits	8 bits

The first three bits of the identifier are used for controlling a message's priority during the arbitration process. A value of zero has the highest priority. Higher priority values are typically given to high-speed control messages.

The next bit of the identifier is reserved for the future use and should be set to zero for transmitted message.

The next bit of the identifier is the data page selector.

The PDU format determines whether the message can be transmitted with a destination address or if the message is always transmitted as a broadcast message.

The interpretation of the PDU specific field changes based on the PF value:

- If the PF is between 0 and 239, the message is addressable and the PS field contains a destination address
- If the PF is between 240 and 255, the message can only be broadcast. The PS field contains a Group Extension.

The term Parameter Group Number (PGN) is used to refer to the value of the Reserve bit, DP, PF, and PS fields combined into a single 18-bit value.

The last 8 bits of the identifier contain the address of the device transmitting the message.

4.1.1 ECU's Address

Each device on the network will be associated with one address. The device address defines a specific communications source or destination for messages. The default CAN address for the MTLT305D/M is 128.

Address 255 is reserved as a global address for broadcast and address 254 is reserved as the “null address” used by devices that have not yet claimed an address or failed to claim an address.

4.1.2 Address Claim

In general, most addresses are pre-assigned and used immediately upon power up. In order to permit J1939 to accommodate future devices and functions, which have not yet been defined, a procedure has been specified for dynamically assigning addresses. Each device must announce which address it is associated with.

MTLT's firmware contains dynamic address assignment and these devices, which might be expected to encounter address conflict, must support this capability. In order to speed up identity process, most ECUs are associated with the preferred address. If the preferred address is already used by another ECU on the same network, the device can attempt to claim another address.

4.1.3 Baud Rate

The J1939 network is intended to be a single, linear, shielded twisted pair of wires running around the vehicle to each ECU. The default data rate of J1939 is 250Kbps. A typical message containing 8 bytes is 128 bits long, which in time is approximately 500 microseconds. MTLT also supports lower speed, 125Kbps and higher speed, 500Kbps.

The baud rate of MTLT is configurable through the RS232 interface using NAV-VIEW.

4.1.4 Get Commands

Get commands are used for another ECUs on the network to collect the corresponding message from MTLT. All of the commands are formed by a Request message of SAEJ1939-21.

4.1.4.1 Firmware Version

MTLT responds to a J1939 packet with PGN number 65242, containing 5-byte payload. Table 5 shows the format of firmware version packet.

Table 5. The format of firmware version response packet

Priority	PGN	PF	PS	SA	Payload
6	65242	254	218		5 bytes

The payload consists of current firmware version in MTLT. See Table 6.

Table 6. Firmware version response payload

Byte 0	Byte 1	Byte 2	Byte 3	Byte 4
Major	Minor	Patch	Stage	Build

4.1.4.2 Rate of periodic data packets

Upon receiving a current rate of periodic packets from another ECU on the network MTLT responds with a packet, containing 2-byte payload. Table 7 shows the format of the response.

Table 7. The format of packet rate divider response packet

Priority	PGN	PF	PS	SA	Payload
6	65365	255	85		2 bytes

The payload consists of address of requesting unit and current rate value of periodic packets in MTLT. See Table 8.

Table 8. Packet rate response payload

Byte 0	Byte 1
DA	Packets rate (see p. 4.1.5.3)

4.1.4.3 Enabled Periodic Data Packets

Upon receiving request of currently enabled periodic data packet types from another ECU on the network MTLT responds with a packet, containing 2-byte payload. Table 9 shows the format of the response.

Table 9. The format of data packet types response packet

Priority	PGN	PF	PS	SA	Payload
6	61366	255	86		2 bytes

The response payload consists of address of requesting unit and bitmask which represents currently enabled periodic packet types. See Table 10.

Table 10. Packet types response payload

Byte 0	Byte 1
DA	Packet types (see p. 4.1.5.4)

It is also possible to request from MTLT specific data packet. The request payload should contain PGN of the specific data packet (see 4.1.6.1, 4.1.6.2 and 4.1.6.3)

4.1.4.4 Active Digital Filters

Upon receiving request about currently active digital filters from another ECU on the network MTLT responds with a packet, containing 3-byte payload. Table 11 shows the format of the response.

Table 11. The format of digital filters response packet

Priority	PGN	PF	PS	SA	Payload
6	65637	255	87		3 bytes

The response payload consists of address of requesting unit and currently active filters for accelerometers and rate sensors data. See Table 12.

Table 12. Active digital filters response payload

Byte 0	Byte 1	Byte 2
DA	Rate sensor filter cutoff frequency (see p. 4.1.5.4)	Accelerometer filter cutoff frequency (see p. 4.1.5.4)

4.1.4.5 Current unit orientation

Upon receiving request about current unit orientation settings from another ECU on the network MTLT responds with a packet, containing 3-byte payload. Table 13 shows the format of the response.

Table 13. The format of unit orientation response packet

Priority	PGN	PF	PS	SA	Payload
6	65637	255	88		3 bytes

The response payload consists of address of requesting unit and current unit orientation settings. See Table 14.

Table 14. Unit orientation response payload

Byte 0	Byte 1	Byte 2
DA	Orientation (MSB) (see p. 4.1.5.6)	Orientation (LSB)

4.1.4.6 ECU's ID

The ID is a 64-bit long label, which gives every ECU a unique identity, following the definition in SAEJ1939-81.

Table 15 shows the format of ID packet.

Table 15. The format of ID command

Priority	PGN	PF	PS	SA	Payload
6	64965	253	197		8 bytes

4.1.4.7 Hardware BIT

Upon receiving a hardwareBit request from another ECU on the network, MTLT responds with a packet with a 2-bit payload. Table 16 shows the format of the hardwareBit packet.



Table 17 shows the content and definition of the 2-bit packet.

Table 16. The format of hardwareBit command

Priority	PGN	PF	PS	SA	Payload
6	65362	255	82		2 Bytes

Table 17. hardwareBit Data Field

Bit	Description	Value	Solution
0	MasterFail	0=normal, 1=fatal error has occurred or unit is in very beginning stage of initialization. The BIT will normally clear after initialization (~0.7s). If the BIT is not cleared the unit is broken.	Power cycle can be tried to recover. If not recovered after power cycle unit should be replaced.
1	HW Error	0=normal, 1=internal hardware error. Indicates sensors initialization or self-test error.	Power cycle can be tried to recover unit. If not recovered after power cycle the unit should be replaced.
2	SW Error	0=normal, 1=internal gyro error, unit in the initialization stage (see Table 11), or algorithm error. The bit will normally clear after initialization (~2s). If the bit is not cleared after initialization, the unit is broken.	Power cycle can be tried to recover unit. If not recovered after power cycle the unit should be replaced.
3 - 15	Reserved	Reserved	

4.1.4.8 Software BIT

Upon receiving a softwareBit request from another ECU on the network, MTLT responds with a packet with 6-bit payload. Table 18 shows the format of the softwareBit packet.

Table 19 shows the contents and definition of softwareBit payload.

Table 18. The format of softwareBit command

Priority	PGN	PF	PS	SA	Payload
6	65363	255	83		2 Bytes



Table 19. softwareBit data field

Bit	Description	Value	Solution
0	softwareError	0=normal, 1=internal software error. Redundant to SW error bit in table 9.	Either bit can be monitored for SW error detection.
1	algorithmError	0=normal, 1=error. Set during algorithm initialization or sensor data over range. In of case of set during initialization, bit normally clear after initialization (~2s). In case of over-range, bit is cleared after over-range condition removed. EKF will converge to correct the solution, or algorithm can be reset.	Algorithm can be reset using command which can be sent over CAN bus (PGN 65360) or unit can be power cycled.
2	dataError	0=normal, 1=error. This bit is redundant with bit 5.	If conditions persist after few power cycles unit is broken and needs to be replaced
3	Initialization	0=normal, 1= Algorithm is in the initialization stage and unit is not ready. Bit will be cleared after initialization is complete (~2s).	If set bit persists after few power cycles unit can be considered broken and needs to be replaced.
4	overRange	0=normal, 1= Indicates an over range event, (rotation exceeding 400 dps or acceleration exceeding 8g. It is cleared when condition is removed. EKF will converge to correct solution or Algorithm can be reset. If condition persists when system is not moving after power cycle – unit is considered to be damaged and needs to be replaced.	Algorithm can be reset using command which can be sent over CAN bus (PGN 65360) or by power cycling unit.
5	Reserved	Reserved	
6	CalibrationCRC Err	0=normal, 1=incorrect calibration CRC or EEPROM write in progress.	Unit needs to be reset (power cycled). If state persists after power cycle – unit considered to be damaged and needs to be replaced.
7 – 15	Reserved	Reserved	

4.1.4.9 Status

Upon receiving a status request from another ECU on the network, MTLT responds with a packet with 9-bit status message.



Table 20 shows the format of sensor status message. Table 21 shows the contents and definition of sensor status payload.

Table 20. The format of sensor status

Priority	PGN	PF	PS	SA	Payload
6	65364	255	84		2 bytes

Table 21. Sensor Status Bits Field

Bit	Description	Value
0	masterStatus	0=normal, 1=hardware, sensor or software alert
1	hardwareStatus	0=normal, 1=programmable alert
2	softwareStatus	0=normal, 1=programmable alert
3	sensorStatus	0=normal, 1=programmable alert
4	Reserved	Reserved
5	Reserved	Reserved
6	Reserved	Reserved
7	unlockedEEPROM	0=locked, 1=unlocked
8	algorithmInit	0=normal, 1=in initial mode
9	Reserved	Reserved
10	Aceinna_attitude_only_algo	0=normal, 1=programmable alert
11	turnSwitch	0=off, 1=yaw rate greater than turnSwitch threshold
12	SensoroverRange	0=not asserted, 1=asserted (when Asserted unit should be reset)
13	Reserved	Reserved
14	Reserved	Reserved
15	Reserved	Reserved

4.1.5 Set Commands

Set commands are used for other ECUs to configure MTLT on the network. All the commands are broadcast messages with a destination address. The receivers will decode the payload and decide to ignore the message meant for another ECU.

4.1.5.1 Configuration Save

The command is issued by an ECU on the network to the destination unit who is requested to save the current configuration in RAM to EEPROM. The receiver will send a response back and notify the sender that save command has been executed successfully or not.



Table 22 shows the format of the save configuration command. Table 23 is the description of save configuration command.

Table 22. The Format of Save Configuration

Priority	PGN	PF	PS	SA	Payload
6	65361	255	81		3 bytes

Table 23. Save Configuration Data Field

Byte	Description	Value
0	Request or Response	0 =Request, 1=Response
1	Address of Unit being saved	Address of destination
2	Success or failure	0=failure, 1=success

4.1.5.2 Algorithm Reset

The algorithm reset command is issued by an ECU on the network to the destination unit who is requested to reset algorithm. The receiver will send a response back and notify the sender that the re-initialization of algorithm has been executed successfully or not. Table 24 shows the format of the algorithm reset command.

Table 24. The format of algorithm reset command

Priority	PGN	PF	PS	SA	Payload
6	65360	255	80		3 bytes

The description of the algorithm reset data field is the same as the save configuration shown data field shown in Table 23.

4.1.5.3 Packet Rate Divider

MTLT broadcasts three types of data packet, slope sensor information 2, angular rate data and linear acceleration data, defined in Table SPNs & PGNs of SAEJ1939-DA. The default ODR of data packets is 100Hz. Packet rate divider command is used to change the ODR setting. The 1st byte of the payload is the destination address and the 2nd byte of the payload sets the new ODRs. Table 25 shows the format of packet rate divider command. The values of packet rate divider are defined in



Table 26.

Table 25. The format of packet rate divider command

Priority	PGN	PF	PS	SA	Payload
6	65365	255	85		2 bytes

Table 26. Packet Rate Divider Field Definition

Byte Value	Packet broadcasting rate
0	Quiet mode
1	100Hz (default)
2	50Hz
4	25Hz
5	20Hz
10	10Hz
20	5Hz
25	4Hz
50	2Hz

4.1.5.4 Data Packet Type

The MTLT305D/M's data packet type follows SAEJ1939-DA Table SPNs & PGN. Users can choose the output packets as single slope sensor information 2 (PGN 61481), angular rate information (PGN 61482) or acceleration sensors (PGN 61485) or any combination of any two or three packet types.

The 1st byte of the payload is the destination address and the 2nd byte of the payload describes the packet type to be set. Table 27 shows the format of data packet type command.

Table 27. The format of Data Packet Type command

Priority	PGN	PF	PS	SA	Payload
6	65366	255	86		2 bytes

The 2nd byte is used to select which data messages are to be transmitted. First Bit selects slope sensor information 2 messages. Second Bit selects Angular rate messages. Third Bit selects acceleration messages. Any combination of 1, 2 or 3 can be selected for transmission. See Table 28.

Table 28. Data Packet Type Field Definition

Byte Value	Data Packet Type
1	SSI2
2	Angular Rate
3	SSI2 and Angular Rate
4	Acceleration
5	SSI2 and Acceleration
6	Angular Rate and Acceleration
7	SSI2, Angular Rate and Acceleration

4.1.5.5 Digital Filter

Users can change the frequencies of low-pass filters applied onto rate sensor or accelerometer. The supported frequencies settings are: 2, 5, 10, 20, 25, 40, and 50 Hz. The frequencies are changed by the command issued by another ECU on the network.

The 1st byte of the payload is the destination address and the 2nd or 3rd byte is the values of low-pass filter frequency to be set to either rate sensor or accelerometer. Table 21 shows the format of digital filter change command.

1st byte: destination address

2nd byte is to set low pass cutoff for rate sensor. Cutoff Frequency choices are 0, 2, 5, 10, 20, 25, 40 and 50Hz

3rd byte is to set low pass cutoff for accelerometer. Cutoff Frequency choices are 0, 2, 5, 10, 20, 25, 40 and 50Hz

Table 29. The format of digital filter change command

Priority	PGN	PF	PS	SA	Payload
6	65367	255	87		3 bytes

4.1.5.6 Orientation

Users may change the coordinate system of MTLT via the command issued by another ECU on the network. The 1st byte of payload is the destination address and the next 2 bytes define the values of the orientation expected to be changed. Table 30 shows the format of orientation command.

Table 30. The format of the orientation command

Priority	PGN	PF	PS	SA	Payload
6	65368	255	88		3 bytes

Table 31 describes the values of the orientation.

Table 31. Orientation Field Byte Values definition

<i>Orientation Field Value</i>	<i>X Axis</i>	<i>Y Axis</i>	<i>Z Axis</i>
0x0000	+Ux	+Uy	+Uz
0x0009	-Ux	-Uy	+Uz
0x0023	-Uy	+Ux	+Uz
0x002A	+Uy	-Ux	+Uz
0x0041	-Ux	+Uy	-Uz
0x0048	+Ux	-Uy	-Uz
0x0062	+Uy	+Ux	-Uz
0x006B	-Uy	-Ux	-Uz
0x0085	-Uz	+Uy	+Ux
0x008C	+Uz	-Uy	+Ux
0x0092	+Uy	+Uz	+Ux
0x009B	-Uy	-Uz	+Ux
0x00C4	+Uz	+Uy	-Ux
0x00CD	-Uz	-Uy	-Ux
0x00D3	-Uy	+Uz	-Ux
0x00DA	+Uy	-Uz	-Ux

<i>Orientation Field Value</i>	<i>X Axis</i>	<i>Y Axis</i>	<i>Z Axis</i>
0x0111	-U _x	+U _z	+U _y
0x0118	+U _x	-U _z	+U _y
0x0124	+U _z	+U _x	+U _y
0x012D	-U _z	-U _x	+U _y
0x0150	+U _x	+U _z	-U _y
0x0159	-U _x	-U _z	-U _y
0x0165	-U _z	+U _x	-U _y
0x016C	+U _z	-U _x	-U _y

4.1.5.7 Bank of PS numbers

Users may change the default PS numbers inside MTLT if the pre-configured values have already been used in their system. PS numbers include hardware bit, software bit, status, packet rate etc. The two commands below are issued by user's ECU and sent to MTLT which is expected to change the corresponding PS values. Table 32 and Table 33 shows the format of these two commands. MTLT will decode the two incoming packets and switch the default PS numbers to the values assigned by users. The new PS numbers will take effect after powering cycle.

Table 32. The format of PS Bank0 command

Priority	PGN	PF	PS	SA	Payload
6	65520	255	240		8 bytes

Bank0 payload contains 8 bytes and each of bytes is the newly assigned PS number to Get or Set commands. The values at byte 0, 2, 3, 4 are new PS numbers of algorithm reset, hardware bit, software bit and status. The remaining bytes are reserved.

Table 33. The format of PS Bank1 command

Priority	PGN	PF	PS	SA	Payload
6	65521	255	241		8 bytes

Bank1 payload contains 8 bytes and each of bytes is the newly assigned PS number to set command. The values at byte 0, 1, 2, 3 are the new PS numbers of packet rate, type, digital filter and orientation. The remaining bytes, 4-7, are reserved.

4.1.6 Data Packets

MTLT outputs three types of data packets. These packets are slope sensor information 2, angular rate and acceleration sensor defined by SAEJ1939-DA.

4.1.6.1 Slope Sensor Information 2

The payload contains 8 bytes in little-endian mode and follows up the definition of SLOT 294 and SAEad11 found in SAEJ1939-DA. The first 24-bit is the pitch value and the next 24-bit is roll value which the range is within -250 to 252 degree and the resolution is 1/32768 deg/bit and an offset of -250 degrees. Table 34 shows the format of SSI2 message.

Table 34. The format of SSI2 packet

Priority	PGN	PF	PS	SA	Payload
3	61481	240	41		8 bytes

4.1.6.2 Angular Rate

The payload contains 8 bytes in little-endian mode and follows the definition of SLOT 288 and SAEva03 found in SAEJ1939-DA. Each of 16 bits is sequentially allocated to the angular velocity, x, y and z, which the range is within -250 to 250.992 deg/s and the resolution, is 1/128 deg/s/bit and an offset of -250 degrees/second. Table 35 shows the format of angular rate message.

Table 35. The format of angular rate packet

Priority	PGN	PF	PS	SA	Payload
3	61482	240	42		8 bytes

◀ NOTE

Aceinna Angular rate packet is arranged as Roll, Pitch, Yaw rates, which is different from J1939 standard. J1939 defines message as Pitch, Roll, and Yaw rate. Scaling and offsets are consistent with the standard.

4.1.6.3 Acceleration Sensor

The payload contains 8 bytes in little-endian mode and follows up the definition of SLOT 303 and SAEad11 found in SAEJ1939-DA. Each of 16 bits is sequentially allocated to the acceleration, x, y and z which the range is within -320 to 320.55 m/s² and the resolution is 0.01 m/s²/bit and an offset of -320 m/s². Table 36 shows the format of acceleration message.

Table 36. The format of acceleration sensor packet

Priority	PGN	PF	PS	SA	Payload
2	61485	240	45		8 bytes

4.2 DBC File

A DBC file is a proprietary but common descriptor database file that is used to describes the CAN network and message decoding. DBC files are created and administered with either the CANdb editor or the CANdb++ editor available from Vector.

The format of DBC file follows the definition of Vector DBC Standard. The link is https://vector.com/vi_candb_en.html

A simplified description of DBC file is available on <https://github.com/stefanhoelzl/CANpy/tree/master/docs>. However, users must contact Vector if the full syntax of DBC file is desired.

A DBC file supporting ACEINNA MTLT305D/M is available for download from ACEINNA website from the MTLT305D/M Product page. <https://www.aceinna.com/inertial-systems/MTLT305D>

5 RS232 Port Interface Definition

The MTLT305D/M Series support a common packet structure that includes both command or input data packets (data sent to the MTLT305D/M Series) and measurement output or response packet formats (data sent from the MTLT305D/M Series). This section of the manual explains these packet formats as well as the supported commands. NAV-VIEW also features a number of tools that can help a user understand the packet types available and the information contained within the packets. This section of the manual assumes that the user is familiar with ANSI C programming language and data type conventions.

For an example of code required to parse input data packets, please see refer to Appendix B: Sample RS232 Packet-Parser Code

For qualified commercial OEM users, a source code license of NAV-VIEW can be made available under certain conditions. Please contact your ACEINNA representative for more information.

5.1 General Settings

The serial port settings are RS232 with 1 start bit, 8 data bits, no parity bit, 1 stop bit, and no flow control. Standard baud rates supported are 38400, 57600, 115200, and 230400.

Common definitions include:

- A word is defined to be 2 bytes or 16 bits.
- All communications to and from the unit are packets that start with a single word alternating bit preamble 0x5555. This is the ASCII string "UU".
- All multiple byte values are transmitted Big Endian (Most Significant Byte First).
- All communication packets end with a single word CRC (2 bytes). CRC's are calculated on all packet bytes excluding the preamble and CRC itself. Input packets with incorrect CRC's will be ignored.
- Each complete communication packet must be transmitted to the MTLT305D/M Series inertial system within a 4 second period.

5.2 Number Formats

Number Format Conventions include:

- 0x as a prefix to hexadecimal values
- single quotes (') to delimit ASCII characters
- no prefix or delimiters to specify decimal values.

Table 37 defines number formats:

Table 37 Number Formats

Descriptor	Description	Size (bytes)	Comment	Range
U1	Unsigned Char	1		0 to 255
U2	Unsigned Short	2		0 to 65535
U4	Unsigned Int	4		0 to 2 ³² -1
I2	Signed Short	2	2's Complement	-2 ¹⁵ to 2 ¹⁵ -1
I2*	Signed Short	2	Shifted 2's Complement	Shifted to specified range
I4	Signed Int	4	2's Complement	-2 ³¹ to 2 ³¹ -1
F4	Floating Point	4	IEEE754 Single Precision	-1*2 ¹²⁷ to 2 ¹²⁷
SN	String	N	ASCII	

5.3 Packet Format

All of the Input and Output packets, except the Ping command, conform to the following structure:

0x5555	<2-byte packet type (U2)>	<payload byte-length (U1)>	<variable length payload>	<2-byte CRC (U2)>
--------	---------------------------	----------------------------	---------------------------	-------------------

The Ping Command does not require a CRC, so a MTLT305D/M Series unit can be pinged from a terminal emulator. To Ping a MTLT305D/M Series unit, type the ASCII string 'UUPK'. If properly connected, the MTLT305D/M Series unit will respond with 'PK'. All other communications with the MTLT305D/M Series unit require the 2-byte CRC. {Note: A MTLT305D/M Series unit will also respond to a ping command using the full packet formation with payload 0 and correctly calculated CRC. Example: 0x5555504B009ef4 }.

5.3.1 Packet Header

The packet header is always the bit pattern 0x5555.

5.3.2 Packet Type

The packet type is always two bytes long in unsigned short integer format. Most input and output packet types can be interpreted as a pair of ASCII characters. As a semantic aid consider the following single character acronyms:

P = packet

F = fields

Refers to Fields which are settings or data contained in the unit

E = EEPROM

Refers to factory data stored in EEPROM

R = read

Reads default non-volatile fields

G = get

Gets current volatile fields or settings

W = write

Writes default non-volatile fields. These fields are stored in non-volatile memory and determine the unit's behavior on power up. Modifying default fields take effect on the next power up and thereafter.

S = set

Sets current volatile fields or settings. Modifying current fields will take effect immediately by modifying internal RAM and are lost on a power cycle

5.3.3 Payload Length

The payload length is always a one byte unsigned character with a range of 0-255. The payload length byte is the length (in bytes) of the *<variable length payload>* portion of the packet ONLY, and does not include the CRC.

5.3.4 Payload

The payload is of variable length based on the packet type.

5.3.5 16-bit CRC-CCITT

Packets end with a 16-bit CRC-CCITT calculated on the entire packet excluding the 0x5555 header and the CRC field itself. A discussion of the 16-bit CRC-CCITT and sample code for implementing the computation of the CRC is included at the end of this document. This 16-bit CRC standard is maintained by the International Telecommunication Union (ITU). The highlights are:

Width = 16 bits

Polynomial 0x1021

Initial value = 0xFFFF

No XOR performed on the final value.

See Appendix D for sample code that implements the 16-bit CRC algorithm.

5.3.6 Messaging Overview

Table 38 summarizes the messages available by MTLT305D/M Series model. Packet types are assigned mostly using the ASCII mnemonics defined above and are indicated in the summary Table 38 and in the detailed sections for each command. The payload byte-length is often related to other data elements in the packet as defined in the table below. The referenced variables are defined in the detailed sections following. Output messages are sent from the MTLT305D/M Series inertial system to the user system as a result of a poll request or a continuous packet output setting. Input messages are sent from the user system to the MTLT305D/M Series inertial system and will result in an associated Reply Message or NAK message. Note that reply messages typically have the same *<2-byte packet type (U2)>* as the input message that evoked it but with a different payload.



Table 38 Message Table

ASCII Mnemonic	<2-byte packet type (U2)>	<payload byte-length (U1)>	Description	Type
Link Test				
PK	0x504B	0	Ping Command and Response	Input/Reply Message
CH	0x4348	N	Echo Command and Response	Input/Reply Message
Interactive Commands				
GP	0x4750	2	Get Packet Request	Input Message
AR	0x4152	0	Algorithm Reset	Input/Reply Message
NAK	0x1515	2	Error Response	Reply Message
Output Messages: Status & Other, (Polled Only)				
ID	0x4944	5+N	Identification Data	Output Message
VR	0x5652	5	Version Data	Output Message
T0	0x5430	28	Test 0 (Detailed BIT and Status)	Output Message
Output Messages: Measurement Data (Continuous or Polled)				
A2	0x4132	30	Angle 2 Data	Output Message
Advanced Commands				
WF	0x5746	numFields*4+1	Write Fields Request	Input Message
WF	0x5746	numFields*2+1	Write Fields Response	Reply Message
SF	0x5346	numFields*4+1	Set Fields Request	Input Message
SF	0x5346	numFields*2+1	Set Fields Response	Reply Message
RF	0x5246	numFields*2+1	Read Fields Request	Input Message
RF	0x5246	numFields*4+1	Read Fields Response	Reply Message
GF	0x4746	numFields*2+1	Get Fields Request	Input Message
GF	0x4746	numFields*4+1	Get Fields Response	Reply Message

6 MTLT305D/M Standard RS232 Port Commands and Messages

6.1 Link Test.

6.1.1 Ping Command

Ping ('PK' = 0x504B)			
Preamble	Packet Type	Length	Termination
0x5555	0x504B	-	-

The ping command has no payload. Sending the ping command will cause the unit to send a ping response. To facilitate human input from a terminal, the length and CRC fields are not required. (Example: 0x5555504B009ef4 or 0x5555504B))

6.1.2 Ping Response

Ping ('PK' = 0x504B)			
Preamble	Packet Type	Length	Termination
0x5555	0x504B	0x00	<CRC (U2)>

The unit will send this packet in response to a ping command.

6.1.3 Echo Command

Echo ('CH' = 0x4348)				
Preamble	Packet Type	Length	Payload	Termination
0x5555	0x4348	N	<echo payload>	<CRC (U2)>

The echo command allows testing and verification of the communication link. The unit will respond with an echo response containing the *echo data*. The *echo data* is N bytes long.

6.1.4 Echo Response

Echo Payload Contents					
Byte Offset	Name	Format	Scaling	Units	Description
0	echoData0	U1	-	-	first byte of echo data
1	echoData1	U1	-	-	Second byte of echo data
...	...	U1	-	-	Echo data
N-2	echoData...	U1	-	-	Second to last byte of echo data
N-1	echoData...	U1	-	-	Last byte of echo data

6.2 Interactive Commands

Interactive commands are used to interactively request data from the MTLT305D/M Series, and to calibrate or reset the MTLT305D/M Series.



6.2.1 Get Packet Request

Get Packet ('GP' = 0x4750)				
Preamble	Packet Type	Length	Payload	Termination
0x5555	0x4750	0x02	<GP payload>	<CRC (U2)>

This command allows the user to poll for both measurement packets and special purpose output packets including 'T0', 'VR', and 'ID'.

GP Payload Contents			
Byte Offset	Name	Format	Description
0	requestedPacketType	U2	The requested packet type

Refer to the sections below for Packet Definitions sent in response to the 'GP' command

6.2.2 Algorithm Reset Command

Algorithm Reset ('AR' = 0x4152)				
Preamble	Packet Type	Length	Payload	Termination
0x5555	0x4152	0x00	-	<CRC (U2)>

This command resets the state estimation algorithm without reloading fields from EEPROM. All current field values will remain in effect. The unit will respond with an algorithm reset response.

6.2.3 Algorithm Reset Response

Algorithm Reset ('AR' = 0x4152)			
Preamble	Packet Type	Length	Termination
0x5555	0x4152	0x00	<CRC (U2)>

The unit will send this packet in response to an algorithm reset command.

6.2.4 Error Response

Error Response (ASCII NAK, NAK = 0x1515)				
Preamble	Packet Type	Length	Payload	Termination
0x5555	0x1515	0x02	<NAK payload>	<CRC (U2)>

The unit will send this packet in place of a normal response to a *failedInputPacketType* request if it could not be completed successfully.

NAK Payload Contents			
Byte Offset	Name	Format	Description
0	failedInputPacketType	U2	the failed request

6.3 Output Packets (Polled)

The following packet formats are special informational packets which can be requested using the ‘GP’ command.

6.3.1 Identification Data Packet

Identification Data (‘ID’ = 0x4944)					
Preamble	Packet Type	Length	Payload		Termination
0x5555	0x4944	5+N	<ID payload>		<CRC (U2)>
This packet contains the unit <i>serialNumber</i> and <i>modelString</i> . The model string is terminated with 0x00. The model string contains the programmed versionString (8-bit Ascii values) followed by the firmware part number string delimited by a whitespace. ID Payload Contents					
Byte Offset	Name	Format	Scaling	Units	Description
0	serialNumber	U4	-	-	Unit serial number
4	modelString	SN	-	-	Unit Version String
4+N	0x00	U1	-	-	Zero Delimiter

6.3.2 Version Data Packet

Version Data (‘VR’ = 0x5652)				
Preamble	Packet Type	Length	Payload	Termination
0x5555	0x5652	5	<VR payload>	<CRC (U2)>

This packet contains firmware version information. *majorVersion* changes may introduce serious incompatibilities. *minorVersion* changes may add or modify functionality, but maintain backward compatibility with previous minor versions. *patch* level changes reflect bug fixes and internal modifications with little effect on the user. The build *stage* is one of the following: 0=release candidate, 1=development, 2=alpha, 3=beta. The *buildNumber* is incremented with each engineering firmware build. The *buildNumber* and *stage* for released firmware are both zero. The final beta candidate is v.w.x.3.y, which is then changed to v.w.x.0.1 to create the first release candidate. The last release candidate is v.w.x.0.z, which is then changed to v.w.x.0.0 for release.

VR Payload Contents			
Byte Offset	Name	Format	Description
0	majorVersion	U1	Major firmware version
1	minorVersion	U1	Minor firmware version
2	patch	U1	Patch level
3	stage	-	Development Stage (0=release candidate, 1=development, 2=alpha, 3=beta)
4	buildNumber	U1	Build number



6.3.3 Test 0 (Detailed BIT and Status) Packet

Test ('T0' = 0x5430)				
Preamble	Packet Type	Length	Payload	Termination
03.3x5555	0x5430	0x1C	<T0 payload>	<CRC (U2)>

This packet contains detailed BIT and status information. The full BIT Status details are described in Appendix D: Advanced RS232 Port BIT.

Table 39. T0 Payload Contents

T0 Payload Contents			
Byte Offset	Name	Format	Description
0	BITstatus	U2	Master BIT and Status Field
2	hardwareBIT	U2	Hardware BIT Field
4	hardwarePowerBIT	U2	Hardware Power BIT Field
6	hardwareEnvironmentalBIT	U2	Hardware Environmental BIT Field
8	comBIT	U2	communication BIT Field
10	comSerialABIT	U2	Communication Serial A BIT Field
12	comSerialBBIT	U2	Communication Serial B BIT Field
14	softwareBIT	U2	Software BIT Field
16	softwareAlgorithmBIT	U2	Software Algorithm BIT Field
18	softwareDataBIT	U2	Software Data BIT Field
20	hardwareStatus	U2	Hardware Status Field
22	comStatus	U2	Communication Status Field
24	softwareStatus	U2	Software Status Field
26	sensorStatus	U2	Sensor Status Field

6.4 RS232 Output Packets (Polled or Continuous)

6.4.1 Angle Data Packet 2 (Default MTLT305D/M Data)

Angle Data ('A2' = 0x4132)				
Preamble	Packet Type	Length	Payload	Termination
0x5555	0x4132	0x1E	<A2 payload>	<CRC (U2)>

This packet contains angle data and selected sensor data scaled in most cases to a signed 2¹⁶ 2's complement number. Data involving angular measurements include the factor pi in the scaling and can be interpreted in either radians or degrees.

Angles: scaled to a range of [-pi,+pi) or [-180 deg to +180 deg).

Angular rates: scaled to range of 3.5* [-pi,+pi) or [-630 deg/sec to +630 deg/sec)

Accelerometers: scaled to a range of [-10,+10) g

Temperature: scaled to a range of [-100, +100) °C



A2 Payload Contents					
Byte Offset	Name	Format	Scaling	Units	Description
0	rollAngle	I2	$2 \cdot \pi / 2^{16}$ [360°/2 ¹⁶]	Radians [°]	Roll angle
2	pitchAngle	I2	$2 \cdot \pi / 2^{16}$ [360°/2 ¹⁶]	Radians [°]	Pitch angle
4	yawAngleTrue	I2	$2 \cdot \pi / 2^{16}$ [360°/2 ¹⁶]	Radians [°]	Yaw angle (free)
6	xRateCorrected	I2	$7 \cdot \pi / 2^{16}$ [1260°/2 ¹⁶]	rad/s [°/sec]	X angular rate corrected
8	yRateCorrected	I2	$7 \cdot \pi / 2^{16}$ [1260°/2 ¹⁶]	rad/s [°/sec]	Y angular rate corrected
10	zRateCorrected	I2	$7 \cdot \pi / 2^{16}$ [1260°/2 ¹⁶]	rad/s [°/sec]	Z angular rate corrected
12	xAccel	I2	$20 / 2^{16}$	G	X accelerometer
14	yAccel	I2	$20 / 2^{16}$	G	Y accelerometer
16	zAccel	I2	$20 / 2^{16}$	G	Z accelerometer
18	xRateTemp	I2	$200 / 2^{16}$	deg. C	X rate temperature
20	yRateTemp	I2	$200 / 2^{16}$	deg. C	Y rate temperature
22	zRateTemp	I2	$200 / 2^{16}$	deg. C	Z rate temperature
24	timeITOW	U4	1	ms	Not Implemented DMU ITOW (sync to GPS)
28	BITstatus	U2	-	-	Master BIT and Status



7 MTLT305D/M Advanced RS232 Port Commands

7.1 Configuration Fields

Configuration fields determine various behaviors of the unit that can be modified by the user. These include settings like baud rate, packet output. The advanced commands allow users to programmatically change the MTLT305D/M Series settings. This section of the manual documents all of the settings and options contained under the Unit Configuration tab within NAV-VIEW. Using these advanced commands, a user's system can change or modify the settings without the need for NAVrate and type, algorithm type, etc. These fields are stored in EEPROM and loaded on power up. These fields can be read from the EEPROM using the 'RF' command. These fields can be written to the EEPROM affecting the default power up behavior using the 'WF' command. The current value of these fields (which may be different from the value stored in the EEPROM) can also be accessed using the 'GF' command. All of these fields can also be modified immediately for the duration of the current power cycle using the 'SF' command. The unit will always power up in the configuration stored in the EEPROM. Configuration fields can only be set or written with valid data from Table below.

Table 40 Configuration Fields

<i>configuration fields</i>	<i>field ID</i>	<i>Valid Values</i>	<i>description</i>
Packet rate divider	0x0001	0,1,2,4,5,10, 20, 25, 50	quiet, 100Hz, 50Hz, 25Hz, 20Hz, 10Hz, 5Hz, 4Hz 2Hz
Unit BAUD rate	0x0002	2,3,5,6	38400, 57600, 115200, 230400
Continuous packet type	0x0003	Any output packet type	Not all output packets available for all products. See detailed product descriptions.
Unused	0x0004		
Gyro Filter Setting	0x0005	18750-65535 [2Hz] 8035-18749 [5Hz] 4018-8034 [10Hz] 2411-4017 [20Hz] 1741-2410 [25Hz] 1205-1740 [40Hz] 1-1204 [50 Hz] 0 [Unfiltered]	Sets low pass cutoff for rate sensors. Cutoff Frequency choices are 2, 5, 10, 20, 25, 40, and 50Hz
Accelerometer Filter Setting	0x0006	18750-65535 [2Hz] 8035-18749 [5Hz] 4018-8034 [10Hz] 2411-4017 [20Hz] 1741-2410 [25Hz] 1205-1740 [40Hz] 1-1204 [50 Hz] 0 [Unfiltered]	Sets low pass cutoff for accelerometers. Cutoff Frequency choices are 2, 5, 10, 20, 25, 40, and 50Hz
Orientation	0x0007	See below	Determine forward, rightward, and downward facing sides
User Behavior Switch	0x0008	Reserved	



Note: BAUD rate SF has immediate effect. Some output data may be lost. Response will be received at new BAUD rate.

7.2 Continuous Packet Type Field

This is the packet type that is being continually output. The supported packet depends on the model number. Please refer to Section 6.4 for a complete list of the available packet types.

7.3 Digital Filter Settings

These two fields set the digital low pass filter cutoff frequencies (See Table 41). Each sensor listed is defined in the default factory orientation. Users must consider any additional rotation to their intended orientation.

Table 41 Digital Filter Settings

Filter Setting	Sensor
FilterGyro	Ux,Uy,Uz Rate
FilterAccel	Ux,Uy,Uz Acceleration

7.4 Orientation Field

This field defines the rotation from the factory to user axis sets. This rotation is relative to the default factory orientation for the MTLT305D/M family model. The default factory axis setting for the MTLT305D/M orientation field is (+Ux +Uy, +Uz) which defines the connector pointing to the opposite of +X direction and +Z direction going out the bottom of the unit. See Figure .

Table 42. MTLT305D/M Orientation Definitions

Description	Bits	Meaning
X Axis Sign	0	0 = positive, 1 = negative
X Axis	1:2	0 = Ux, 1 = Uy, 2 = Uz, 3 = N/A
Y Axis Sign	3	0 = positive, 1 = negative
Y Axis	4:5	0 = Uy, 1 = Uz, 2 = Ux, 3 = N/A
Z Axis Sign	6	0 = positive, 1 = negative
Z Axis	7:8	0 = Uz, 1 = Ux, 2 = Uy, 3 = N/A
Reserved	9:15	N/A

There are 24 possible orientation configurations (See Table 43). Setting/Writing the field to anything else generates a NAK and has no effect.

Table 43 MTLT305D/M Orientation Fields

Orientation Field Value	X Axis	Y Axis	Z Axis
0x0000	+Ux	+Uy	+Uz
0x0009	-Ux	-Uy	+Uz
0x0023	-Uy	+Ux	+Uz



<i>Orientation Field Value</i>	<i>X Axis</i>	<i>Y Axis</i>	<i>Z Axis</i>
0x002A	+Uy	-Ux	+Uz
0x0041	-Ux	+Uy	-Uz
0x0048	+Ux	-Uy	-Uz
0x0062	+Uy	+Ux	-Uz
0x006B	-Uy	-Ux	-Uz
0x0085	-Uz	+Uy	+Ux
0x008C	+Uz	-Uy	+Ux
0x0092	+Uy	+Uz	+Ux
0x009B	-Uy	-Uz	+Ux
0x00C4	+Uz	+Uy	-Ux
0x00CD	-Uz	-Uy	-Ux
0x00D3	-Uy	+Uz	-Ux
0x00DA	+Uy	-Uz	-Ux
0x0111	-Ux	+Uz	+Uy
0x0118	+Ux	-Uz	+Uy
0x0124	+Uz	+Ux	+Uy
0x012D	-Uz	-Ux	+Uy
0x0150	+Ux	+Uz	-Uy
0x0159	-Ux	-Uz	-Uy
0x0165	-Uz	+Ux	-Uy
0x016C	+Uz	-Ux	-Uy

7.5 User Behavior Switches

This field allows on the fly user interaction with behavioral aspects of the algorithm (See Table 44).

Table 44 MTLT305D/M Behavior Switches

<i>Description</i>	<i>Bits</i>	<i>Meaning</i>
Free Integrate	0	0 = use feedback to stabilize the algorithm 1 = 6DOF inertial integration without stabilized feedback for 60 seconds
Reserved	1	Set to 0
Reserved	2	Set to 0
Reserved	3	Set to 0
Restart on Over-range	4	0 = Do not restart the system after a sensor over-range, 1 = restart the system after a sensor over-range
Reserved	5	Reserved
Reserved	6:15	N/A



7.6 Commands to Program Configuration Over RS232

7.6.1 Write Fields Command

Write Fields ('WF' = 0x5746)				
Preamble	Packet Type	Length	Payload	Termination
0x5555	0x5746	1+numFields*4	<WF payload>	<CRC (U2)>

This command allows the user to write default power-up configuration fields to the EEPROM. Writing the default configuration will not take effect until the unit is power cycled. *NumFields* is the number of words to be written. The *field0*, *field1*, etc. are the field

IDs that will be written with the *field0Data*, *field1Data*, etc., respectively. The unit will not write to calibration or algorithm fields. If at least one field is successfully written, the unit will respond with a write fields response containing the field IDs of the successfully written fields. If any field is unable to be written, the unit will respond with an error response. Note that both a write fields and an error response may be received as a result of a write fields command. Attempts to write a field with an invalid value is one way to generate an error response. A table of field IDs and valid field values is available in Section 7.1.

WF Payload Contents					
Byte Offset	Name	Format	Scaling	Units	Description
0	numFields	U1	-	-	The number of fields to write
1	field0	U2	-	-	The first field ID to write
3	field0Data	U2	-	-	The first field ID's data to write
5	field1	U2	-	-	The second field ID to write
7	field1Data	U2	-	-	The second field ID's data
...	...	U2	-	-	...
numFields*4 -3	field...	U2	-	-	The last field ID to write
numFields*4 -1	field...Data	U2	-	-	The last field ID's data to write

Write Fields Response

Write Fields ('WF' = 0x5746)				
Preamble	Packet Type	Length	Payload	Termination
0x5555	0x5746	1+numFields*2	<WF payload>	<CRC (U2)>

The unit will send this packet in response to a write fields command if the command has completed without errors.

WF Payload Contents					
Byte Offset	Name	Format	Scaling	Units	Description
0	numFields	U1	-	-	The number of fields written



1	field0	U2	-	-	The first field ID written
3	field1	U2	-	-	The second field ID written
...	...	U2	-	-	More field IDs written
numFields*2 - 1	Field...	U2	-	-	The last field ID written

7.6.2 Set Fields Command

Set Fields ('SF' = 0x5346)				
Preamble	Packet Type	Length	Payload	Termination
0x5555	0x5346	1+numFields*4	<SF payload>	<CRC (U2)>

This command allows the user to set the unit's current configuration (SF) fields immediately which will then be lost on power down. *NumFields* is the number of words to be set. The *field0*, *field1*, etc. are the field IDs that will be written with the *field0Data*, *field1Data*, etc., respectively. This command can be used to set configuration fields. The unit will not set calibration or algorithm fields. If at least one field is successfully set, the unit will respond with a set fields response containing the field IDs of the successfully set fields. If any field is unable to be set, the unit will respond with an error response. Note that both a set fields and an error response may be received as a result of one set fields command. Attempts to set a field with an invalid value is one way to generate an error response. A table of field IDs and valid field values is available in Section 7.1.

SF Payload Contents					
Byte Offset	Name	Format	Scaling	Units	Description
0	numFields	U1	-	-	The number of fields to set
1	field0	U2	-	-	The first field ID to set
3	field0Data	U2	-	-	The first field ID's data to set
5	field1	U2	-	-	The second field ID to set
7	field1Data	U2	-	-	The second field ID's data to set
...	...	U2	-	-	...
numFields*4 -3	field...	U2	-	-	The last field ID to set
numFields*4 -1	field...Data	U2	-	-	The last field ID's data to set

Set Fields Response

Set Fields ('SF' = 0x5346)				
Preamble	Packet Type	Length	Payload	Termination
0x5555	0x5346	1+numFields*2	<SF payload>	<CRC (U2)>

The unit will send this packet in response to a set fields command if the command has completed without errors.



SF Payload Contents			
Byte Offset	Name	Format	Description
0	numFields	U1	The number of fields to set
1	field0	U2	The first field ID to set
3	field1	U2	The second field ID to set
...	...	U2	More field IDs to set
numFields*2 - 1	Field...	U2	The last field ID to set

7.7 Read Fields Command

Read Fields ('RF' = 0x5246)				
Preamble	Packet Type	Length	Payload	Termination
0x5555	0x5246	1+numFields*2	<RF payload>	<CRC (U2)>

This command allows the user to read the default power-up configuration fields from the EEPROM. *NumFields* is the number of fields to read. The *field0*, *field1*, etc. are the field IDs to read. RF may be used to read configuration and calibration fields from the EEPROM. If at least one field is successfully read, the unit will respond with a read fields response containing the field IDs and data from the successfully read fields. If any field is unable to be read, the unit will respond with an error response. Note that both a read fields and an error response may be received as a result of a read fields command.

RF Payload Contents			
Byte Offset	Name	Format	Description
0	numFields	U1	The number of fields to read
1	field0	U2	The first field ID to read
3	field1	U2	The second field ID to read
...	...	U2	More field IDs to read
numFields*2 - 1	Field...	U2	The last field ID to read

7.8 Read Fields Response

Read Fields ('RF' = 0x5246)				
Preamble	Packet Type	Length	Payload	Termination
0x5555	0x5246	1+numFields*4	<RF payload>	<CRC (U2)>

The unit will send this packet in response to a read fields request if the command has completed without errors.



RF Payload Contents					
Byte Offset	Name	Format	Scaling	Units	Description
0	numFields	U1	-	-	The number of fields read
1	field0	U2	-	-	The first field ID read
3	field0Data	U2	-	-	The first field ID's data read
5	field1	U2	-	-	The second field ID read
7	field1Data	U2	-	-	The second field ID's data read
...	...	U2	-	-	...
numFields*4 -3	field...	U2	-	-	The last field ID read
numFields*4 -1	field...Data	U2	-	-	The last field ID's data read

7.9 Get Fields Command

Get Fields ('GF' = 0x4746)				
Preamble	Packet Type	Length	Payload	Termination
0x5555	0x4746	1+numFields*2	<GF Data>	<CRC (U2)>

This command allows the user to get the unit's current configuration fields. *NumFields* is the number of fields to get. The *field0*, *field1*, etc. are the field IDs to get. GF may be used to get configuration, calibration, and algorithm fields from RAM. Multiple algorithm fields will not necessarily be from the same algorithm iteration. If at least one field is successfully collected, the unit will respond with a get fields response with data containing the field IDs of the successfully received fields. If any field is unable to be received, the unit will respond with an error response. Note that both a get fields and an error response may be received as the result of a get fields command.

GF Payload Contents					
Byte Offset	Name	Format	Scaling	Units	Description
0	numFields	U1	-	-	The number of fields to get
1	field0	U2	-	-	The first field ID to get
3	field1	U2	-	-	The second field ID to get
...	...	U2	-	-	More field IDs to get
numFields*2 - 1	Field...	U2	-	-	The last field ID to get

7.10 Get Fields Response

Get Fields ('GF' = 0x4746)				
Preamble	Packet Type	Length	Payload	Termination
0x5555	0x4746	1+numFields*4	<GF Data>	<CRC (U2)>

The unit will send this packet in response to a get fields request if the command has completed without errors.



GF Payload Contents					
Byte Offset	Name	Format	Scaling	Units	Description
0	numFields	U1	-	-	The number of fields retrieved
1	field0	U2	-	-	The first field ID retrieved
3	field0Data	U2	-	-	The first field ID's data retrieved
5	field1	U2	-	-	The second field ID retrieved
7	field1Data	U2	-	-	The second field ID's data
...	...	U2	-	-	...
numFields*4 -3	field...	U2	-	-	The last field ID retrieved
numFields*4 -1	field...Data	U2	-	-	The last field ID's data retrieved

8 Bootloader

8.1 Bootloader Initialization

A user can initiate Bootloader at any time by sending 'JI' command (see below command's format) to application program. This command forces the unit enter Bootloader mode. The unit will communicate at 57.6Kbps baud rate regardless of the original baud rate the unit is configured to. The Bootloader always communicates at 57.6Kbps until the firmware upgrade is complete.

As an additional device recovery option immediately after powering up, every MTLT3xD will enter a recovery window of 100ms prior to application start. During this 100mS window, the user can send 'JI' command at 57.6Kbs to the Bootloader in order to force the unit to remain in Bootloader mode.

Once the device enters Bootloader mode via the 'JI' command either during recovery window or from normal operation, a user can send a sequence 'WA' commands to write a complete application image into the device's FLASH.

After loading the entire firmware image with successive 'WA' commands, a 'JA' command is sent to instruct the unit to exit Bootloader mode and begin application execution. At this point, the device will return to its original baud rate.

Optionally, the system can be reboot by cycling power to restart the system.

8.2 Firmware Upgrade Command

The commands detailed in Sections 8.2.1 are used for upgrading a new firmware version.

8.2.1 UART Interface

Firmware upgrade is performed by a Write APP command through UART port, through Windows GUI, NAV-View, or a python program. See Appendix A: Installation and Operation of NAV-VIEW over RS232

The following commands allow users to install a pre-built binary into flash memory and force system to enter either Bootloader or application mode.

8.2.1.1 Jump to Bootloader Command

Jump To Bootloader ('JI' = 0x4A49)				
Preamble	Packet Type	Length	Payload	Termination
0x5555	0x4A49	0x00		CRC (U2)

The command allows system to enter Bootloader mode.

8.2.1.2 Write APP Command

Write APP ("WA" = 0x5741)				
Preamble	Packet Type	Length	Payload	Termination
0x5555	0x5741	length+5		CRC (U2)

The command allows users to write binary sequentially to flash memory in Bootloader mode. The total length is the sum of payload's length and 4-byte address followed by 1-byte data length. See the following table of the payload's format.

WA Payload Contents					
Byte Offset	Name	Format	Scaling	Units	Description
0	startingAddress	U4	-	bytes	The FLASH word offset to begin writing data
4	byteLength	U1	-	bytes	The word length of the data to write
5	dataByte0	U1	-	-	FLASH data
6	dataByte1	U1	-	-	FLASH data
...	...				
4+byteLength	dataByte	U1	-	-	FLASH data

Payload starts from 4-byte address of flash memory where the binary is located. The fifth byte is the number of bytes of *dataBytes*, but less than 240 bytes. User must truncate the binary to less than 240-byte blocks and fill each of blocks into payload starting from the sixth-byte.

8.2.1.3 Jump to Application Command

Jump To Application ('JA' = 0x4A41)				
Preamble	Packet Type	Length	Payload	Termination
0x5555	0x4A41	0x00		CRC (U2)

The command allows system directly to enter application mode.

9 Warranty and Support Information

9.1 Customer Service

As a ACEINNA customer you have access to product support services, which include:

- Single-point return service
- Web-based support service
- Same day troubleshooting assistance
- Worldwide ACEINNA representation
- Onsite and factory training available
- Preventative maintenance and repair programs
- Installation assistance available

9.2 Contact Directory

Email: techsupport@aceinna.com

<http://www.aceinna.com/support/index.cfm>

9.3 Return Procedure

9.3.1 Authorization

Before returning any equipment, please contact ACEINNA to obtain a Returned Material Authorization number (RMA).

Be ready to provide the following information when requesting a RMA:

- Name
- Address
- Telephone, Fax, Email
- Equipment Model Number
- Equipment Serial Number
- Installation Date
- Failure Date
- Fault Description
- Will it connect to NAV-VIEW 3.X?

9.3.2 Identification and Protection

If the equipment is to be shipped to ACEINNA for service or repair, please attach a tag **TO THE EQUIPMENT**, as well as the shipping container(s), identifying the owner. Also indicate the service or repair required, the problems encountered, and other information considered valuable to the service facility such as the list of information provided to request the RMA number.

Place the equipment in the original shipping container(s), making sure there is adequate packing around all sides of the equipment. If the original shipping containers were discarded, use heavy boxes with adequate padding and protection.

9.3.3 Sealing the Container

Seal the shipping container(s) with heavy tape or metal bands strong enough to handle the weight of the equipment and the container.

9.3.4 Marking

Please write the words, “FRAGILE, DELICATE INSTRUMENT” in several places on the outside of the shipping container(s). In all correspondence, please refer to the equipment by the model number, the serial number, and the RMA number.

9.4 Warranty

The ACEINNA product warranty is one year from date of shipment.

Appendix A: Installation and Operation of NAV-VIEW over RS232

NAV-VIEW has been designed to allow users to control all aspects of the MTLT305D/M Series operation including data recording, configuration and data transfer. For the first time, you will be able to control the orientation of the unit, sampling rate, packet type, hard iron calibration and filter settings through NAV-VIEW. For proper use with the MTLT305D/M family version 3.5.5 or higher of NAV-VIEW is required.

NAV-VIEW Computer Requirements

The following are minimum requirements for the installation of the NAV-VIEW Software:

- CPU: Pentium-class (1.5GHz minimum)
- RAM Memory: 500MB minimum, 1GB+ recommended
- Hard Drive Free Memory: 20MB
- Operating System: Windows 7, 8 and 10
- Properly installed Microsoft .NET 2.0 or higher

Install NAV-VIEW

To install NAV-VIEW onto your computer:

1. Insert the CD “Inertial Systems Product Support” (Part No. 8160-0063) in the CD-ROM drive.
2. Locate the “NAV-VIEW” folder. Double click on the “setup.exe” file.
3. Follow the setup wizard instructions. You will install NAV-VIEW and .NET 2.0 framework.

Connections

The MTLT3 Series Inertial Systems products can be purchased with a with a 6-pin Ampseal 16 to 6 Position connector to flying lead cable. In order to connect to NAV-VIEW, the cable can be attached to a standard DB9 connector.

1. Connect the blue wire (Ampseal pin 4 - RS232-RX) to the host system RS232 TX pin.
2. Connect the white wire (Ampseal pin 5 - RS232-TX) to the host system RS232 RX pin.
3. Connect the black wire (Ampseal pin 3 - GND) to host system and power supply ground.
4. Connect the red wire (Ampseal pin 6 - Power) to power supply positive, 5-32VDC.

◀ NOTE

Allow at least 30 seconds after power up for the MTLT3 Series product for initialization. The MTLT3 Series needs to be held motionless during this period.

⚠ WARNING

Do not reverse the power leads! Reversing the power leads to the MTLT305D/M Series can damage the unit; although there is reverse power protection, ACEINNA is not responsible for resulting damage to the unit should the reverse voltage protection electronics fail.

Setting up NAV-VIEW

With the MTLT305D/M Series product powered up and connected to your PC serial port, open the NAV-VIEW software application.

1. NAV-VIEW should automatically detect the MTLT305D/M Series product and display the serial number and firmware version if it is connected.
2. If NAV-VIEW does not connect, check that you have the correct COM port selected. You will find this under the “Setup” menu. Select the appropriate COM port and allow the unit to automatically match the baud rate by leaving the “Auto: match baud rate” selection marked.
3. If the status indicator at the bottom is green and states, **Unit Connected**, you’re ready to go. If the status indicator doesn’t say connected and is red, check the connections between the MTLT305D/M Series product and the computer, check the power supply, and verify that the COM port is not occupied by another device.
4. Under the “View” menu you have several choices of data presentation. Graph display is the default setting and will provide a real time graph of all the MTLT305D/M Series data. The remaining choices will be discussed in the following pages.

Data Recording

NAV-VIEW allows the user to log data to a text file (.txt) using the simple interface at the top of the screen. Customers can now tailor the type of data, rate of logging and can even establish predetermined recording lengths.

To begin logging data follow the steps below (See Figure 6):

1. Locate the  icon at the top of the page or select “Log to File” from the “File” drop down menu.
2. The following menu will appear.

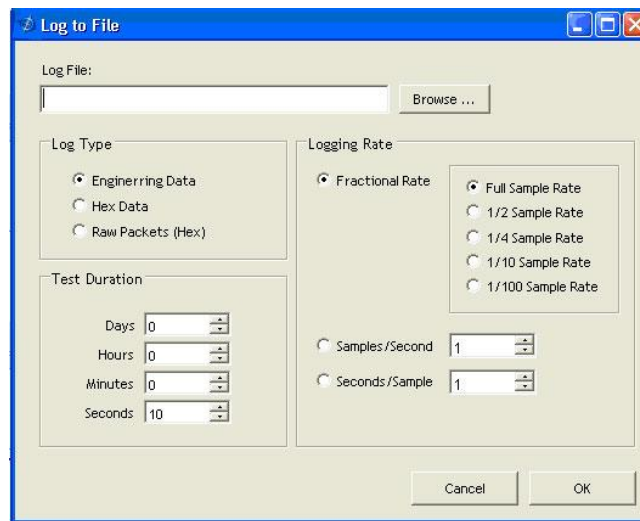





Figure 6 Log to File Dialog Screen

3. Select the “Browse” box to enter the file name and location that you wish to save your data to.

4. Select the type of data you wish to record. “Engineering Data” records the converted values provided from the system in engineering units, “Hex Data” provides the raw hex values separated into columns displaying the value, and the “Raw Packets” will simply record the raw hex strings as they are sent from the unit.
5. Users can also select a predetermined “Test Duration” from the menu. Using the arrows, simply select the duration of your data recording.
6. Logging Rate can also be adjusted using the features on the right side of the menu.
7. Once you have completed the customization of your data recording, you will be returned to the main screen where you can start the recording process using the  button at the top of the page or select “Start Logging” from the “File” menu. Stopping the data recording can be accomplished using the  button and the recording can also be paused using the  button.

Data Playback

In addition to data recording, NAV-VIEW allows the user to replay saved data that has been stored in a log file.

1. To playback data, select “Playback Mode” from the “Data Source” drop down menu at the top.

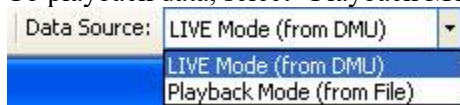

2. Selecting Playback mode will open a text prompt which will allow users to specify the location of the file they wish to play back. All three file formats are supported (Engineering, Hex, and Raw) for playback. In addition, each time recording is stopped/started a new section is created. These sections can be individually played back by using the drop down menu and associated VCR controls.
3. Once the file is selected, users can utilize the VCR style controls at the top of the page to start, stop, and pause the playback of the data.
4. NAV-VIEW also provides users with the ability to alter the start time for data playback. Using the  slide bar at the top of the page users can adjust the starting time.

Raw Data Console

NAV-VIEW offers some unique debugging tools that may assist programmers in the development process. One such tool is the Raw Data Console. From the “View” drop down menu, simply select the “Raw Data Console”. This console provides users with a simple display of the packets that have been transmitted to the unit (Tx) and the messages received (Rx). An example is provided in Figure 7.

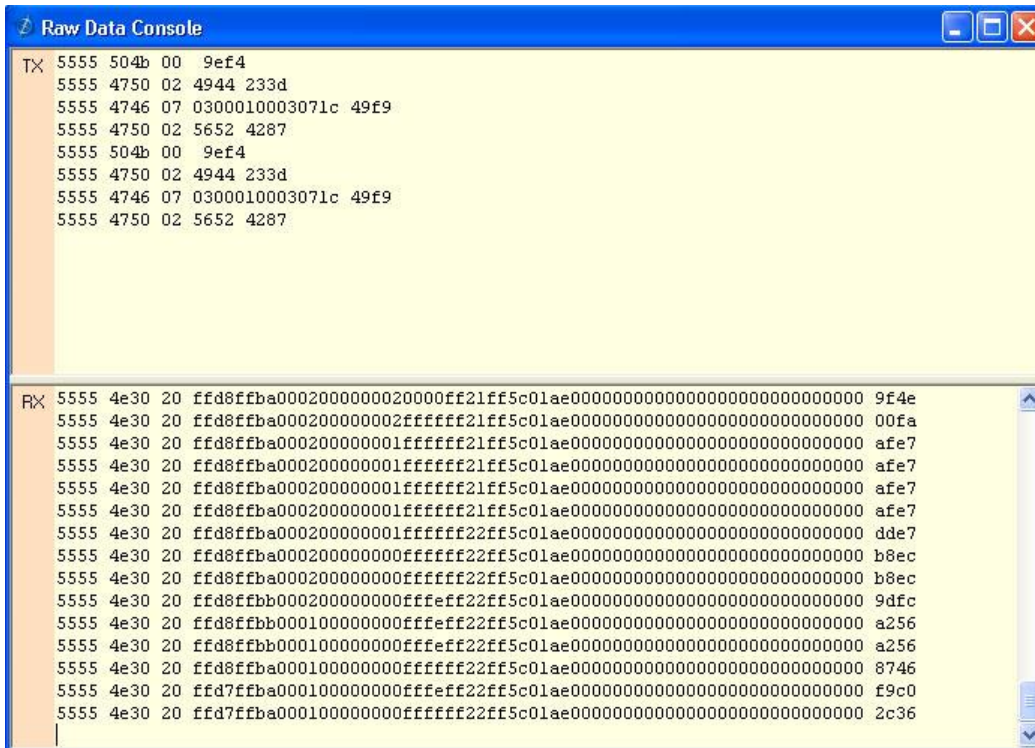

Figure 7 Raw Data Console

Horizon and Compass View

If the MTLT305D/M Series product you have connected is capable of providing heading and angle information (see Table 2), NAV-VIEW can provide a compass and a simulated artificial horizon view. To activate these views, simply select “Horizon View” and/or “Compass View” from the “View” drop down menu at the top of the page. See Figure 8.

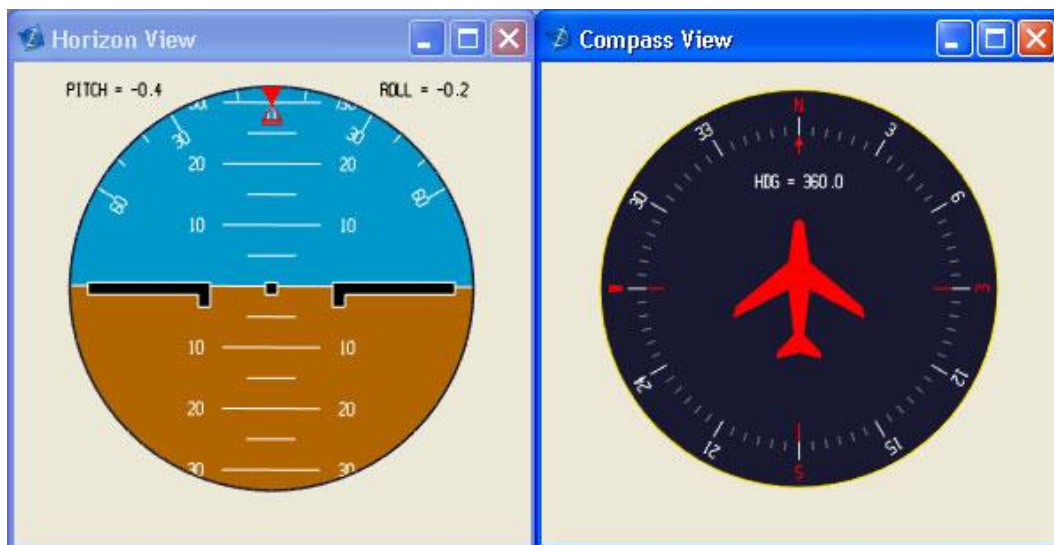

Figure 8 Horizon and Compass View

Packet Statistics View

Packet statistics can be obtained from the “View” menu by selecting the “Packet Statistics” option (See Figure 9). This view simply provides the user with a short list of vital statistics (including Packet Rate, CRC Failures, and overall Elapsed Time) that are calculated over a one second window. This tool should be used to gather information regarding the overall health of the user configuration. Incorrectly configured communication settings can result in a large number of CRC Failures and poor data transfer.

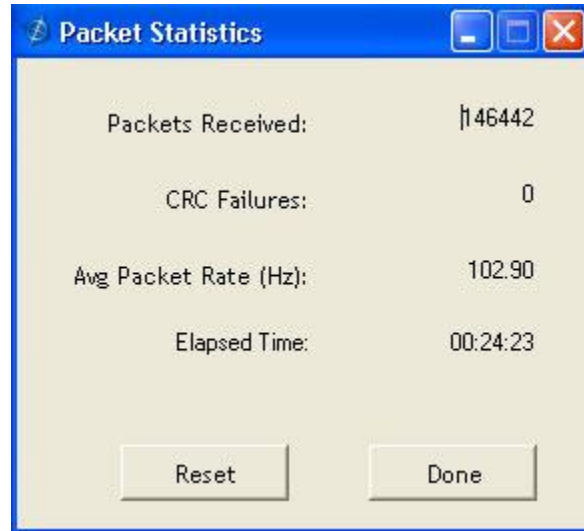

Figure 9 Packet Statistics

Unit Configuration

The Unit Configuration window (See Figure 10) gives the user the ability to view and alter the system settings. This window is accessed through the “Unit Configuration” menu item under the configuration menu. Under the “General” tab, users have the ability to verify the current configuration by selecting the “Get All Values” button. This button simply provides users with the currently set configuration of the unit and displays the values in the left column of boxes.

There are three tabs within the “Unit Configuration” menu; General, Advanced and BIT Configuration. The General tab displays some of the most commonly used settings. The Advanced and BIT Configuration menus provide users with more detailed setting information that they can tailor to meet their specific needs.

To alter a setting, simply select the check box on the left of the value that you wish to modify and then select the value using the drop down menu on the right side. Once you have selected the appropriate value, these settings can be set temporarily or permanently (a software reset or power cycle is required for the changes to take affect) by selecting from the choices at the bottom of the dialog box. Once the settings have been altered a “Success” box will appear at the bottom of the page.

IMPORTANT

Caution must be taken to ensure that the settings selected are compatible with the system that is being configured. In most cases a “FAIL” message will appear if incompatible selections are made by the user, however it is the users responsibility to ensure proper configuration of the unit.

IMPORTANT

Unit orientation selections must conform to the right hand coordinate system as noted in Section 3.1 of this user manual. Selecting orientations that do not conform to these criteria are not allowed.

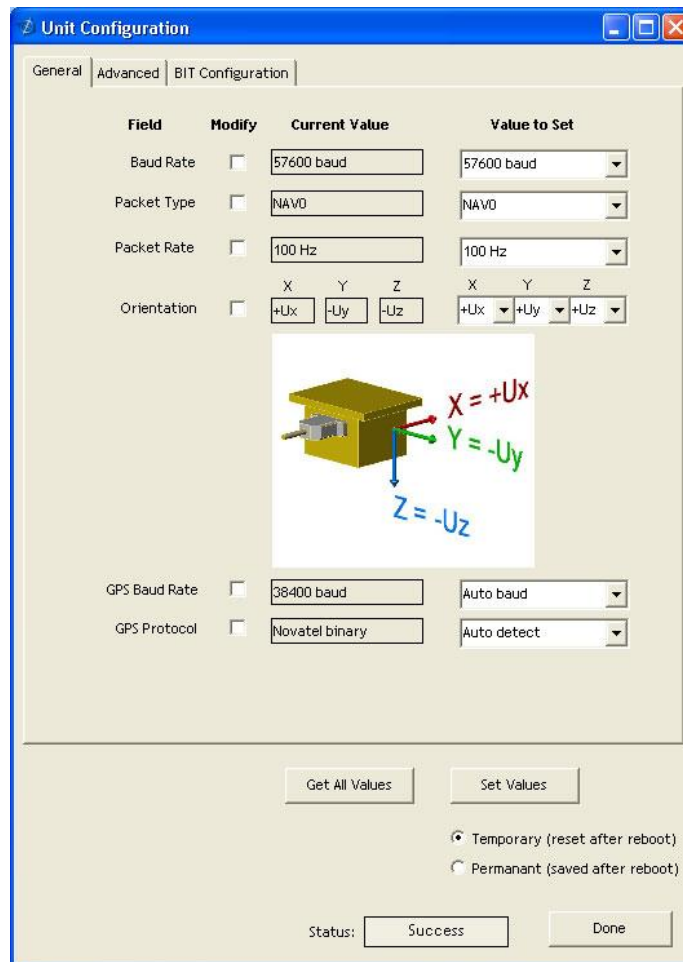

Figure 10 Unit Configuration

Advanced Configuration

Users who wish to access some of the more advanced features of NAV-VIEW and the MTLT305D/M Series products can do so by selecting the “Advanced” tab at the top of the “Unit Configuration” window.

WARNING

Users are strongly encouraged to read and thoroughly understand the consequences of altering the settings in the “Advanced” tab before making changes to the unit configuration. These settings are discussed in detail in Chapter 4 below.

Behavior switches are identified at the top of the page with marked boxes. A blue box will appear if a switch has been enabled similar to Figure below. The values can be set in the same manner as noted in the previous section. To set a value, users select the appropriate “Modify” checkbox on the left side of the menu and select or enable the appropriate value they wish to set. At the bottom of the page, users have the option of temporarily or permanently setting values. When all selections have been finalized, simply press the “Set Values” button to change the selected settings.

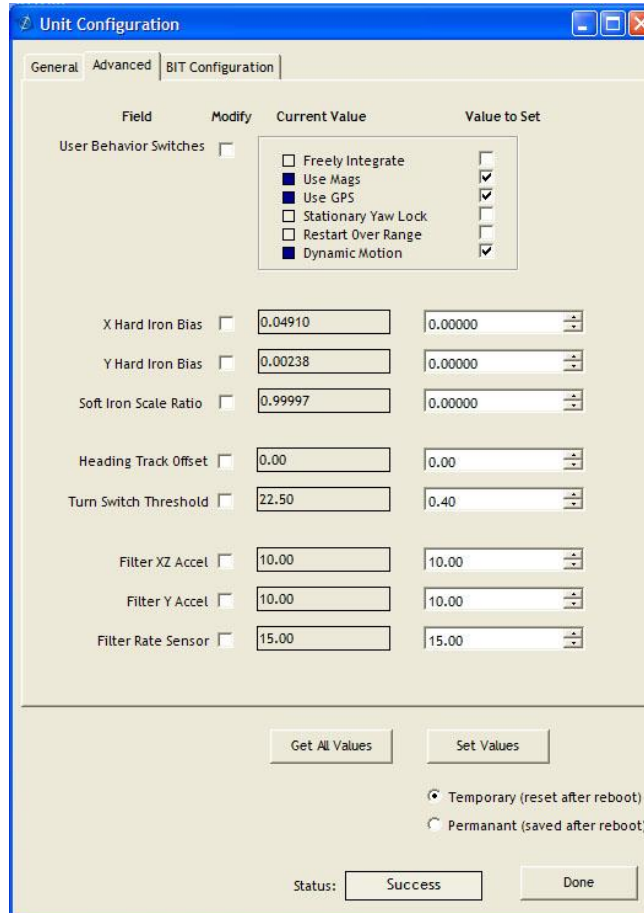

Figure 11 Advanced Settings

Bit Configuration

The third and final tab of the unit configuration window is “Bit Configuration” (See Figure 12). This tab allows the users to alter the logic of individual status flags that affect the masterStatus flag in the master BITstatus field (available in most output packets). By enabling individual status flags users can determine which flags are logically OR’ed to generate the masterStatus flag. This gives the user the flexibility to listen to certain indications that affect their specific application. The masterFail and all error flags are not configurable. These flags represent serious errors and should never be ignored.

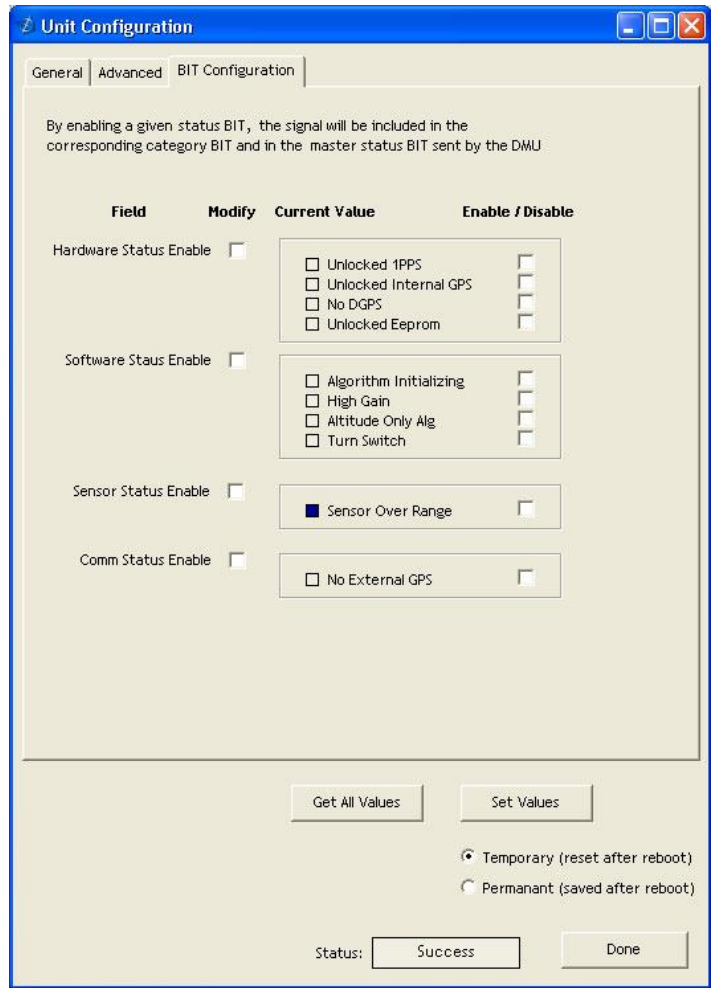
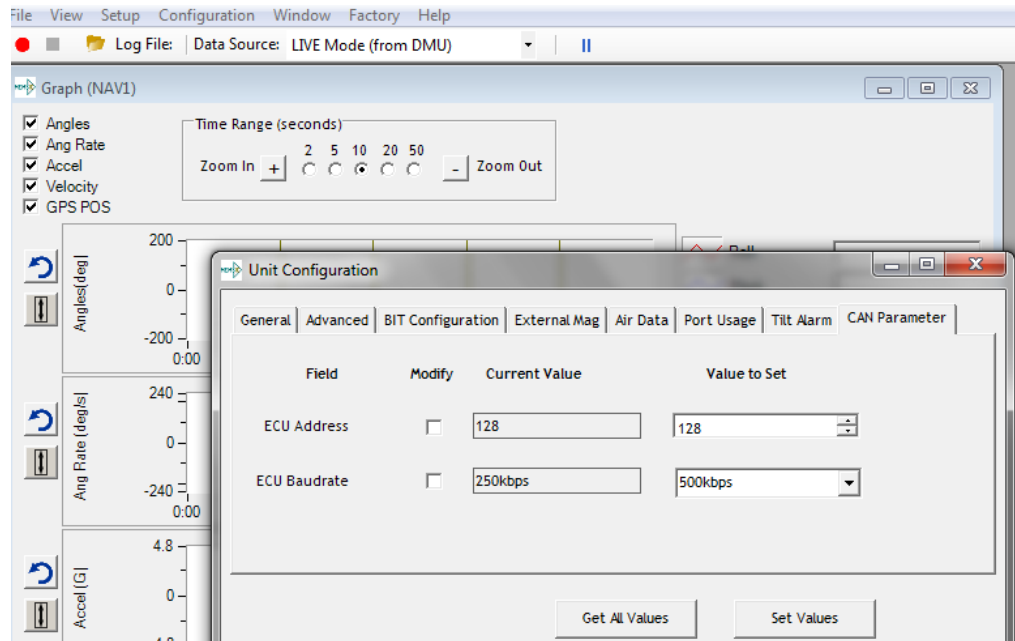

Figure 12. Bit Configuration

CAN configuration

MTLT's address is configurable through NAV-VIEW, or automatically assigned by address claiming protocol if the existing address is conflict with another ECU on the same network. See below Figure 6.

Click Menu Configuration, then select Unit Configuration and click the tab, CAN Parameter. Choose the address' value, then click the button Set Values.



Firmware Upgrade

Step 1, select Firmware upgrade from configuration menu.

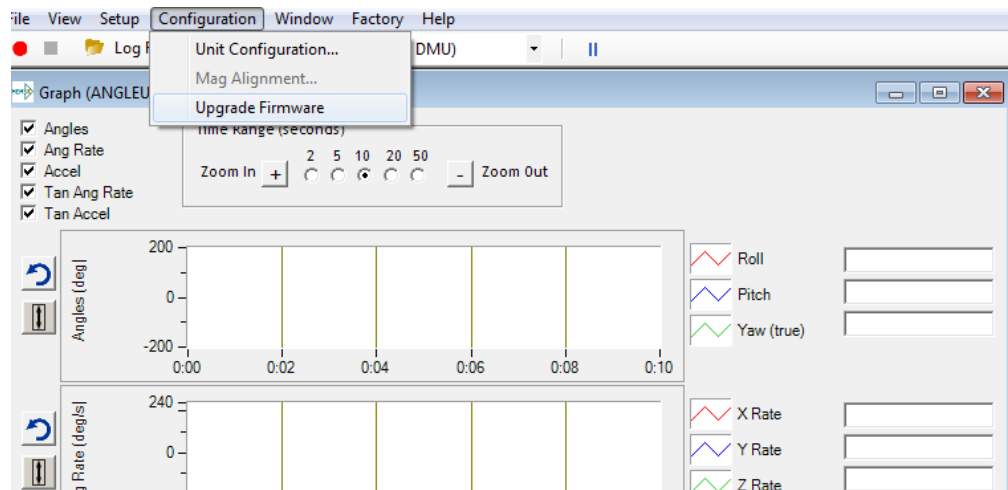

Step 2, On pop-up window, select a new version binary file by clicking SELECT button, then click Upgrade button.

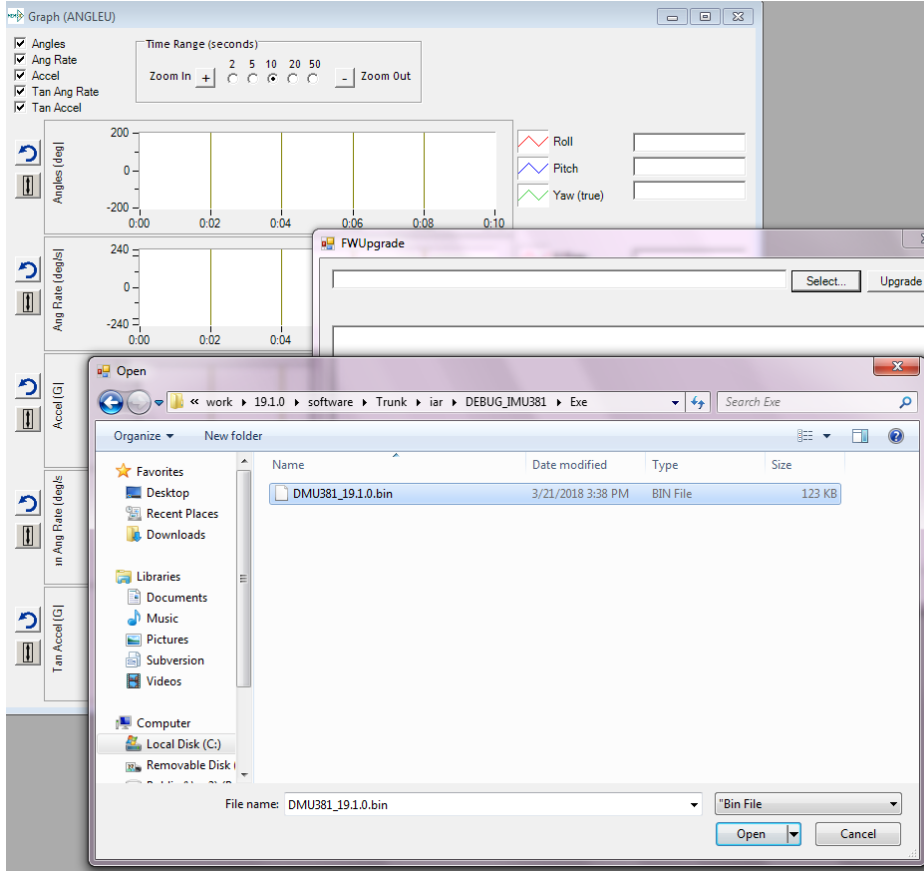

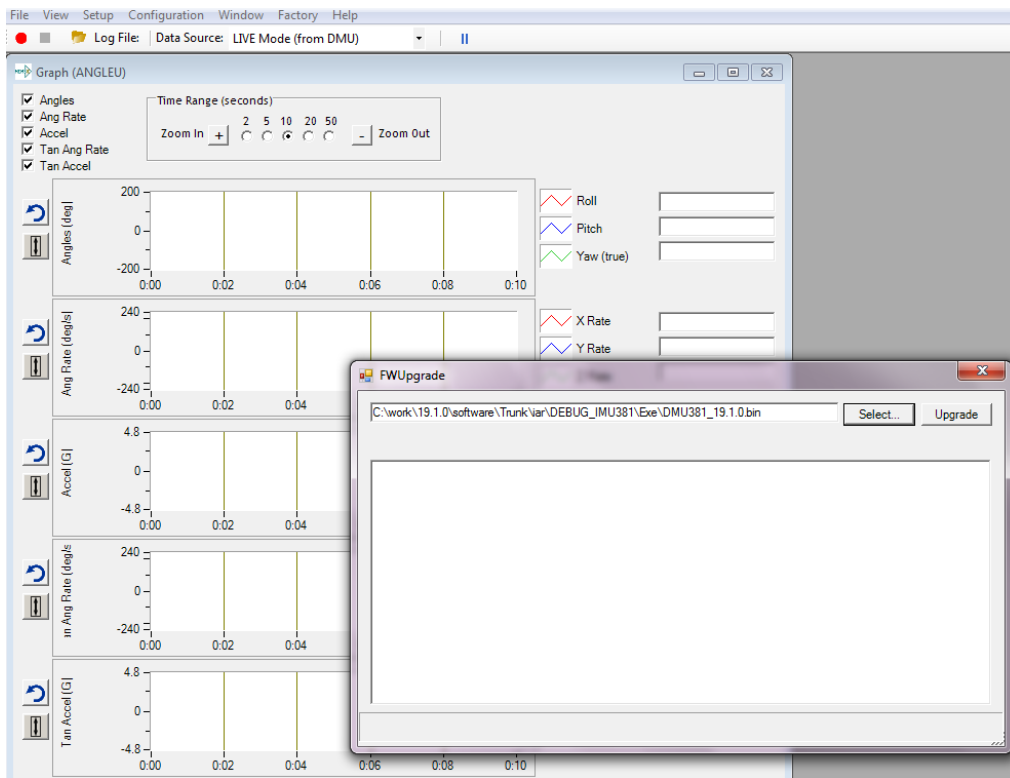

Step 3, wait for the process ongoing until a successful or failure message pops up.

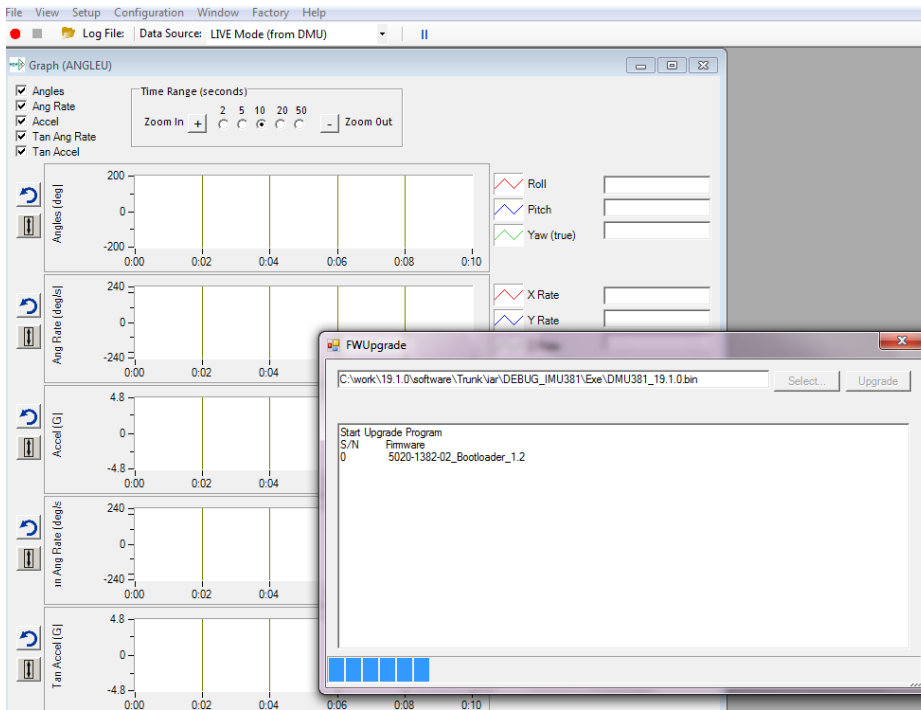

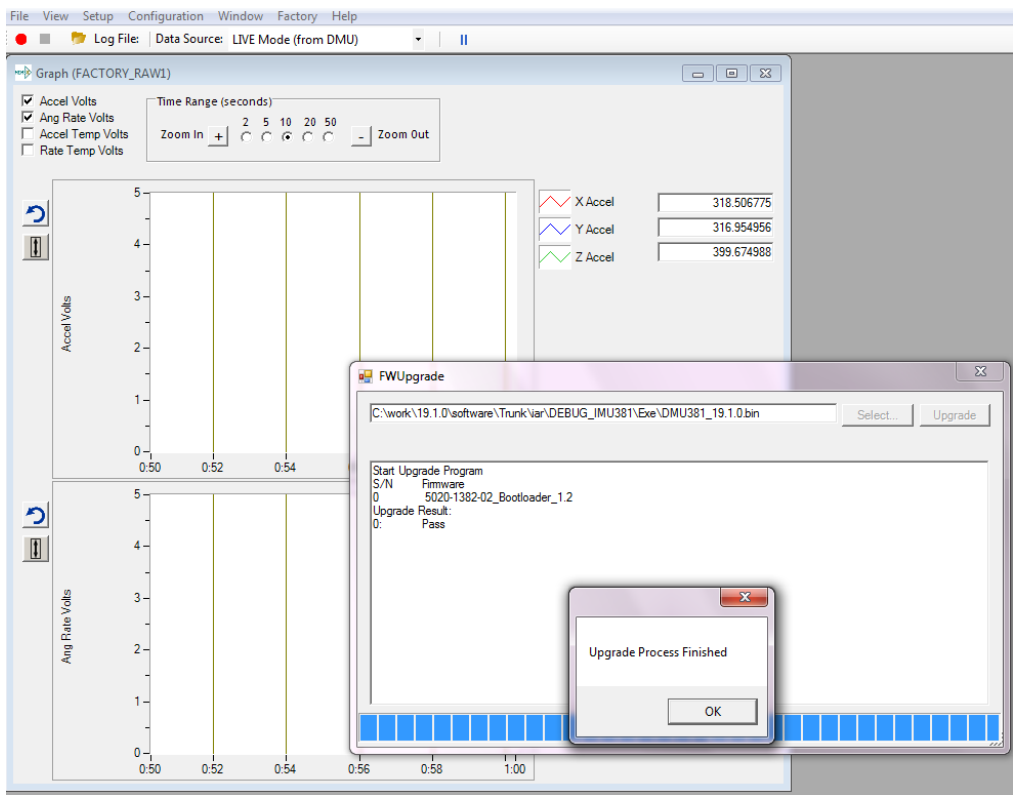

Appendix B: Sample RS232 Packet-Parser Code

Overview

This appendix includes sample code written in ANSI C for parsing packets from data sent by the MTLT305D/M Series Product over the RS232 Port. This code can be used by a user application reading data directly from the MTLT305D/M Series product, or perhaps from a log file.

The sample code contains the actual parser, but also several support functions for CRC calculation and circular queue access.:

- **process_aceinna_packet** – for parsing out packets from a queue. Returns these fields in structure ACEINNA_PACKET (see below). Checks for CRC errors
- **calcCRC** – for calculating CRC on packets.
- **Initialize** - initialize the queue
- **AddQueue** - add item in front of queue
- **DeleteQueue** - return an item from the queue
- **peekWord** - for retrieving 2-bytes from the queue, without popping
- **peekByte** – for retrieving a byte from the queue without popping
- **Pop** - discard item(s) from queue
- **Size** – returns number of items in queue
- **Empty** – return 1 if queue is empty, 0 if not
- **Full** - return 1 if full, 0 if not full

The parser will parse the queue looking for packets. Once a packet is found and the CRC checks out, the packet's fields are placed in the ACEINNA_PACKET structure. The parser will then return to the caller. When no packets are found the parser will simply return to the caller with return value 0.

The ACEINNA_PACKET structure is defined as follows:

```
typedef struct aceinna_packet
{
    unsigned short packet_type;
    char          length;
    unsigned short crc;
    char          data[256];
} ACEINNA_PACKET;
```

Typically, the parser would be called within a loop in a separate process, or in some time triggered environment, reading the queue looking for packets. A separate process might add data to this queue when it arrives. It is up to the user to ensure circular-queue integrity by using some sort of mutual exclusion mechanism within the queue access functions.

Code listing for RS232 Packet Decoding

```
#include <stdio.h>
/* buffer size */
#define MAXQUEUE 500
/*
 * circular queue
 */
typedef struct queue_tag
{
    int count;
    int front;
    int rear;
    char entry[MAXQUEUE];
} QUEUE_TYPE;

/*
 * ACEINNA packet
 */
typedef struct aceinna_packet
{
    unsigned short packet_type;
    char          length;
    unsigned short crc;
    char          data[256];
} ACEINNA_PACKET;

QUEUE_TYPE circ_buf;

/*****
 * FUNCTION: process_Aceinna_packet looks for packets in a queue
 * ARGUMENTS: queue_ptr: is pointer to queue to process
 *
 *           result: will contain the parsed info when return value is 1
 * RETURNS:   0 when failed.
 *           1 when successful
 *****/
int process_aceinna_packet(QUEUE_TYPE *queue_ptr, ACEINNA_PACKET *result)
{
    unsigned short myCRC = 0, packetCRC = 0, packet_type = 0, numToPop=0, counter=0;
    char packet[100], tempchar, dataLength;

    if(Empty(queue_ptr))
```

```

{
    return 0; /* empty buffer */
}

/* find header */
for(numToPop=0; numToPop+1<Size(queue_ptr) ;numToPop+=1)
{
    if(0x5555==peekWord(queue_ptr, numToPop)) break;
}

Pop(queue_ptr, numToPop);

if(Size(queue_ptr) <= 0)
{
    /* header was not found */
    return 0;
}

/* make sure we can read through minimum length packet */
if(Size(queue_ptr)<7)
{
    return 0;
}

/* get data length (5th byte of packet) */
dataLength = peekByte(queue_ptr, 4);

/* make sure we can read through entire packet */
if(Size(queue_ptr) < 7+dataLength)
{
    return 0;
}

/* check CRC */
myCRC = calcCRC(queue_ptr, 2,dataLength+3);
packetCRC = peekWord(queue_ptr, dataLength+5);

if(myCRC != packetCRC)
{
    /* bad CRC on packet - remove the bad packet from the queue and return */
    Pop(queue_ptr, dataLength+7);
}

```

```

        return 0;
    }

    /* fill out result of parsing in structure */
    result->packet_type = peekWord(queue_ptr, 2);
    result->length      = peekByte(queue_ptr, 4);
    result->crc         = packetCRC;
    for(counter=0; counter < result->length; counter++)
    {
        result->data[counter] = peekByte(queue_ptr, 5+counter);
    }

    Pop(queue_ptr, dataLength+7);

    return 1;
}

/*****
 * FUNCTION: calcCRC calculates a 2-byte CRC on serial data using
 *          CRC-CCITT 16-bit standard maintained by the ITU
 *          (International Telecommunications Union).
 * ARGUMENTS: queue_ptr is pointer to queue holding area to be CRCed
 *            startIndex is offset into buffer where to begin CRC calculation
 *            num is offset into buffer where to stop CRC calculation
 * RETURNS:   2-byte CRC
 *****/
unsigned short calcCRC(Queue_Type *queue_ptr, unsigned int startIndex, unsigned int num) {
    unsigned int i=0, j=0;
    unsigned short crc=0x1D0F; //non-augmented initial value equivalent to augmented initial value
    0xFFFF

    for (i=0; i<num; i+=1) {
        crc ^= peekByte(queue_ptr, startIndex+i) << 8;

        for(j=0;j<8;j+=1) {
            if(crc & 0x8000) crc = (crc << 1) ^ 0x1021;
            else crc = crc << 1;
        }
    }
    return crc;
}

```



```

/*****
 * FUNCTION: Initialize - initialize the queue
 * ARGUMENTS: queue_ptr is pointer to the queue
 *****/
void Initialize(Queue_TYPE *queue_ptr)
{
    queue_ptr->count = 0;
    queue_ptr->front = 0;
    queue_ptr->rear = -1;
}

/*****
 * FUNCTION: AddQueue - add item in front of queue
 * ARGUMENTS: item holds item to be added to queue
 *             queue_ptr is pointer to the queue
 * RETURNS:   returns 0 if queue is full. 1 if successful
 *****/
int AddQueue(char item, Queue_TYPE *queue_ptr)
{
    int retval = 0;
    if(queue_ptr->count >= MAXQUEUE)
    {
        retval = 0; /* queue is full */
    }
    else
    {
        queue_ptr->count++;
        queue_ptr->rear = (queue_ptr->rear + 1) % MAXQUEUE;
        queue_ptr->entry[queue_ptr->rear] = item;
        retval = 1;
    }
    return retval;
}

/*****
 * FUNCTION: DeleteQueue - return an item from the queue
 * ARGUMENTS: item will hold item popped from queue
 *             queue_ptr is pointer to the queue
 * RETURNS:   returns 0 if queue is empty. 1 if successful
 *****/
int DeleteQueue(char *item, Queue_TYPE *queue_ptr)
{

```

```

int retval = 0;
if(queue_ptr->count <= 0)
{
    retval = 0; /* queue is empty */
}
else
{
    queue_ptr -> count--;
    *item = queue_ptr->entry[queue_ptr->front];
    queue_ptr->front = (queue_ptr->front+1) % MAXQUEUE;
    retval=1;
}
return retval;
}

/*****
* FUNCTION: peekByte returns 1 byte from buffer without popping
* ARGUMENTS: queue_ptr is pointer to the queue to return byte from
*             index is offset into buffer to which byte to return
* RETURNS:   1 byte
* REMARKS:   does not do boundary checking. please do this first
*****/
char peekByte(Queue_TYPE *queue_ptr, unsigned int index) {
    char byte;
    int firstIndex;

    firstIndex = (queue_ptr->front + index) % MAXQUEUE;

    byte = queue_ptr->entry[firstIndex];
    return byte;
}

/*****
* FUNCTION: peekWord returns 2-byte word from buffer without popping
* ARGUMENTS: queue_ptr is pointer to the queue to return word from
*             index is offset into buffer to which word to return
* RETURNS:   2-byte word
* REMARKS:   does not do boundary checking. please do this first
*****/
unsigned short peekWord(Queue_TYPE *queue_ptr, unsigned int index) {
    unsigned short word, firstIndex, secondIndex;

```



```

firstIndex = (queue_ptr->front + index) % MAXQUEUE;
secondIndex = (queue_ptr->front + index + 1) % MAXQUEUE;

word = (queue_ptr->entry[firstIndex] << 8) & 0xFF00;
word |= (0x00FF & queue_ptr->entry[secondIndex]);
return word;
}

/*****
* FUNCTION: Pop - discard item(s) from queue
* ARGUMENTS: queue_ptr is pointer to the queue
*             numToPop is number of items to discard
* RETURNS:   return the number of items discarded
*****/
int Pop(Queue_Type *queue_ptr, int numToPop)
{
    int i=0;
    char tempchar;
    for(i=0; i<numToPop; i++)
    {
        if(!DeleteQueue(&tempchar, queue_ptr))
        {
            break;
        }
    }
    return i;
}

/*****
* FUNCTION: Size
* ARGUMENTS: queue_ptr is pointer to the queue
* RETURNS:   return the number of items in the queue
*****/
int Size(Queue_Type *queue_ptr)
{
    return queue_ptr->count;
}

/*****
* FUNCTION: Empty
* ARGUMENTS: queue_ptr is pointer to the queue

```



```

* RETURNS:    return 1 if empty, 0 if not
*****/
int Empty(Queue_Type *queue_ptr)
{
    return queue_ptr->count <= 0;
}

/*****
* FUNCTION: Full
* ARGUMENTS: queue_ptr is pointer to the queue
* RETURNS:    return 1 if full, 0 if not full
*****/
int Full(Queue_Type *queue_ptr)
{
    return queue_ptr->count >= MAXQUEUE;
}

```

Appendix C: RS232 Sample Packet Decoding

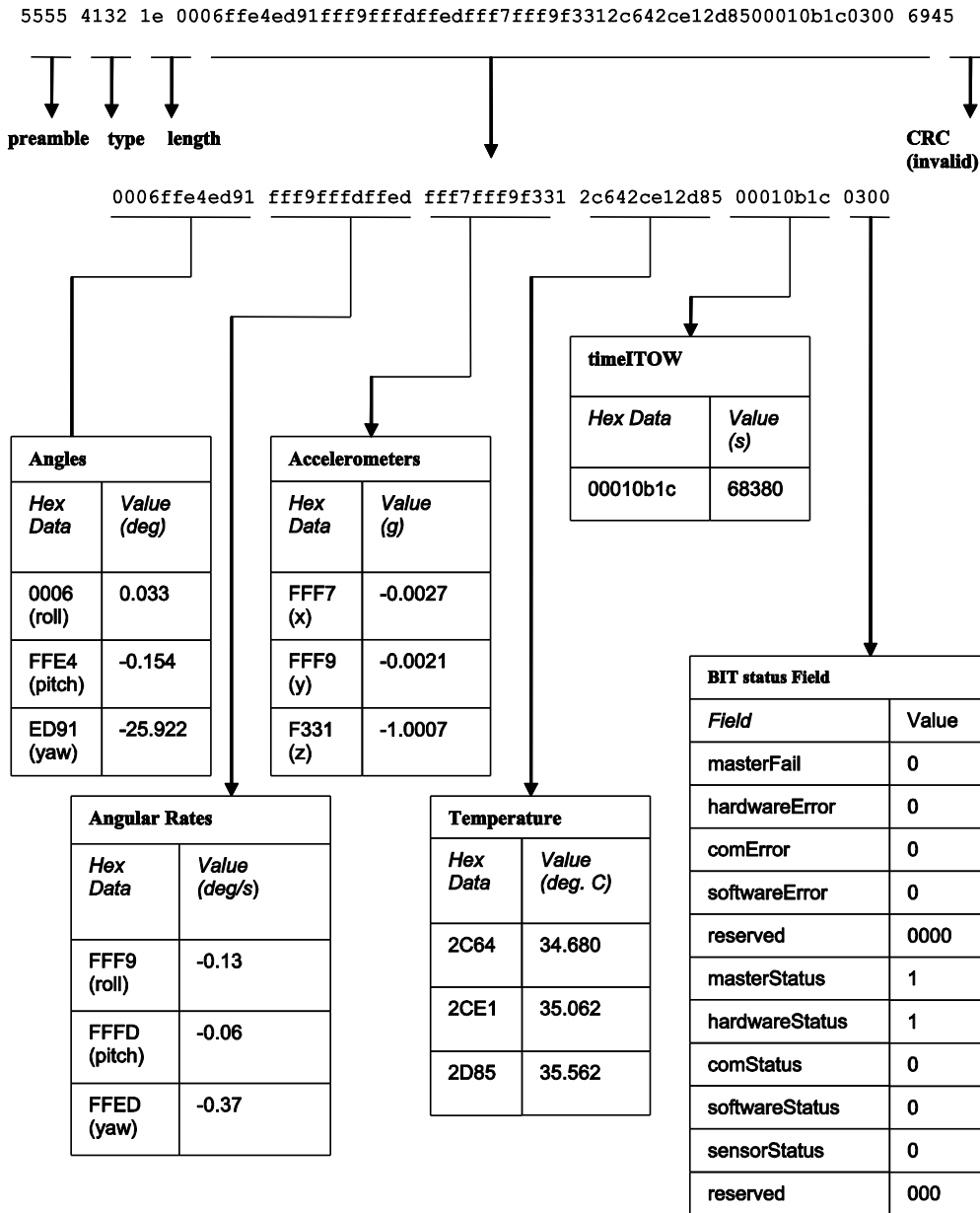

Figure 13 Example payload from Angle Data Packet 2 (A2)

Appendix D: Advanced RS232 Port BIT

Built In Test (BIT) and Status Fields

Internal health and status are monitored and communicated in both hardware and software. The masterFail flag is thrown as a result of a number of instantly fatal conditions (known as a “hard” failure) or a persistent serious problem (known as a “soft” failure). Soft errors are those which must be triggered multiple times within a specified time window to be considered fatal. Soft errors are managed using a digital high-pass error counter with a trigger threshold.

The masterStatus flag is a configurable indication as determined by the user. This flag is asserted as a result of any asserted alert signals which the user has enabled.

The hierarchy of BIT and Status *fields* and signals is depicted here:

❖ *BITstatus Field*

- masterFail
 - hardwareError
 - comError
 - *comBIT Field*
 - ◆ serialAError
 - *comSerialABIT Field*
 - transmitBufferOverflow
 - receiveBufferOverflow
 - framingError
 - breakDetect
 - parityError
 - softwareError
 - *softwareBIT Field*
 - ◆ algorithmError
 - *softwareAlgorithmBIT Field*
 - initialization
 - overRange
 - ◆ dataError
 - *softwareDataBIT Field*
 - calibrationCRCErr
- masterStatus
 - hardwareStatus
 - *hardwareStatus Field*



- ◆ unlockedEEPROM
- softwareStatus
 - *softwareStatus Field*
 - ◆ algorithmInitialization (enabled by default)
 - ◆ highGain (enabled by default)
 - ◆ attitudeOnlyAlgorithm
 - ◆ turnSwitch
- sensorStatus
 - *sensorStatus Field*
 - ◆ overRange (enabled by default)

Master BIT and Status (BITstatus) Field

The BITstatus field is the global indication of health and status of the MTLT305D/M Series product . The LSB contains BIT information and the MSB contains status information.

There are four intermediate signals that are used to determine when masterFail and the hardware BIT signal are asserted. These signals are controlled by various systems checks in software that are classified into three categories: hardware, communication, and software. Instantaneous soft failures in each of these four categories will trigger these intermediate signals, but will not trigger the masterFail until the persistency conditions are met.

There are four intermediate signals that are used to determine when the masterStatus flag is asserted: hardwareStatus, sensorStatus, comStatus, and softwareStatus. masterStatus is the logical OR of these intermediate signals. Each of these intermediate signals has a separate field with individual indication flags. Each of these indication flags can be enabled or disabled by the user. Any enabled indication flag will trigger the associated intermediate signal and masterStatus flag.

MTLT305D/M BIT Status Field

<i>BITstatus Field</i>	<i>Bits</i>	<i>Meaning</i>	<i>Category</i>
masterFail	0	0 = normal, 1 = fatal error has occurred	BIT
HardwareError	1	0 = normal, 1= internal hardware error	BIT
comError	2	0 = normal, 1 = communication error	BIT
softwareError	3	0 = normal, 1 = internal software error	BIT
Reserved	4:7	N/A	
masterStatus	8	0 = nominal, 1 = hardware, sensor, com, or software alert	Status
hardwareStatus	9	0 = nominal, 1 = programmable alert	Status
comStatus	10	0 = nominal, 1 = programmable alert	Status
softwareStatus	11	0 = nominal, 1 = programmable alert	Status
sensorStatus	12	0 = nominal, 1 = programmable alert	Status
Reserved	13:15	N/A	

comBIT Field

The comBIT field contains flags that indicate communication errors with external devices . Each external device has an associated message with low level error signals. The comError flag in the BITstatus field is the bit-wise OR of this comBIT field.

MTLT305D/M COM BIT Field

<i>comBIT Field</i>	<i>Bits</i>	<i>Meaning</i>	<i>Category</i>
serialAError	0	0 = normal, 1 = error	Soft
Reserved	2:15	N/A	

comSerialABIT Field

The comSerialABIT field contains flags that indicate low level errors with external serial port A (the user serial port). The serialAError flag in the comBIT field is the bit-wise OR of this comSerialABIT field.

MTLT305D/M Serial Port A BIT Field

<i>comSerialABIT Field</i>	<i>Bits</i>	<i>Meaning</i>	<i>Category</i>
transmitBufferOverflow	0	0 = normal, 1 = overflow	Soft
receiveBufferOverflow	1	0 = normal, 1 = overflow	Soft
framingError	2	0 = normal, 1 = error	Soft
breakDetect	3	0 = normal, 1 = error	Soft
parityError	4	0 = normal, 1 = error	Soft
Reserved	5:15	N/A	

softwareBIT Field

The softwareBIT field contains flags that indicate various types of software errors. Each type has an associated message with low level error signals. The softwareError flag in the BITstatus field is the bit-wise OR of this softwareBIT field.

MTLT305D/M Software BIT Field

<i>softwareBIT Field</i>	<i>Bits</i>	<i>Meaning</i>	<i>Category</i>
algorithmError	0	0 = normal, 1 = error	Soft
dataError	1	0 = normal, 1 = error	Soft
Reserved	2:15	N/A	

softwareAlgorithmBIT Field

The softwareAlgorithmBIT field contains flags that indicate low level software algorithm errors. The algorithmError flag in the softwareBIT field is the bit-wise OR of this softwareAlgorithmBIT field.



MTLT305D/M Software Algorithm BIT Field

<i>SoftwareAlgorithmBIT Field</i>	<i>Bits</i>	<i>Meaning</i>	<i>Category</i>
initialization	0	0 = normal, 1 = error during algorithm initialization	Hard
overRange	1	0 = normal, 1 = fatal sensor over-range	Hard
Reserved	3:15	N/A	

softwareDataBIT Field

The softwareDataBIT field contains flags that indicate low level software data errors . The dataError flag in the softwareBIT field is the bit-wise OR of this softwareDataBIT field.

MTLT305D/M Software Data BIT Field

<i>SoftwareDataBIT Field</i>	<i>Bits</i>	<i>Meaning</i>	<i>Category</i>
calibrationCRCErrror	0	0 = normal, 1 = incorrect CRC on calibration EEPROM data or data has been compromised by a WE command.	Hard
Reserved	2:15	N/A	

hardwareStatus Field

The hardwareStatus field contains flags that indicate various internal hardware conditions and alerts that are not errors or problems. The hardwareStatus flag in the BITstatus field is the bit-wise OR of the logical AND of the hardwareStatus field and the hardwareStatusEnable field. The hardwareStatusEnable field is a bit mask that allows the user to select items of interest that will logically flow up to the masterStatus flag.

MTLT305D/M Hardware Status BIT Field

<i>hardwareStatus Field</i>	<i>Bits</i>	<i>Meaning</i>
unlockedEEPROM	3	0=locked, WE disabled, 1=unlocked, WE enabled
Reserved	4:15	N/A

softwareStatus Field

The softwareStatus field contains flags that indicate various software conditions and alerts that are not errors or problems. The softwareStatus flag in the BITstatus field is the bit-wise OR of the logical AND of the softwareStatus field and the softwareStatusEnable field. The softwareStatusEnable field is a bit mask that allows the user to select items of interest that will logically flow up to the masterStatus flag.

MTLT305D/M Software Status Field

<i>softwareStatus Field</i>	<i>Bits</i>	<i>Meaning</i>
algorithmInit	0	0 = normal, 1 = the algorithm is in initialization mode
Reserved	1	Reserved
attitudeOnlyAlgorithm	2	0 = navigation state tracking, 1 = attitude only state tracking
turnSwitch	3	0 = off, 1 = yaw rate greater than turnSwitch threshold
Reserved	4:15	N/A

sensorStatus Field

The sensorStatus field contains flags that indicate various internal sensor conditions and alerts that are not errors or problems. The sensorStatus flag in the BITstatus field is the bit-wise OR of the logical AND of the sensorStatus field and the sensorStatusEnable field. The sensorStatusEnable field is a bit mask that allows the user to select items of interest that will logically flow up to the masterStatus flag.

MTLT305D/M Sensor Status Field

<i>sensorStatus Field</i>	<i>Bits</i>	<i>Meaning</i>
overRange	0	0 = not asserted, 1 = asserted
Reserved	1:15	N/A

Configuring the Master Status

The masterStatus byte and its associated programmable alerts are configured using the Read Field and Write Field command as described in Section 0, Advanced Commands. The below table shows the definition of the bit mask for configuring the status signals.

MTLT305D/M Master Status Byte Configuration Fields

<i>configuration fields</i>	<i>field ID</i>	<i>Valid Values</i>	<i>Description</i>
hardwareStatusEnable	0x0010	Any	Bit mask of enabled hardware status signals
comStatusEnable	0x0011	Any	Bit mask of enabled communication status signals
softwareStatusEnable	0x0012	Any	Bit mask of enabled software status signals
sensorStatusEnable	0x0013	Any	Bit mask of enabled sensor status signals

hardwareStatusEnable Field

This field is a bit mask of the hardwareStatus field (see BIT and status definitions). This field allows the user to determine which low level hardwareStatus field signals will flag the hardwareStatus and masterStatus flags in the BITstatus field. Any asserted bits in this field imply that the corresponding hardwareStatus field signal, if asserted, will cause the hardwareStatus and masterStatus flags to be asserted in the BITstatus field.

comStatusEnable Field

This field is a bit mask of the comStatus field (see BIT and status definitions). This field allows the user to determine which low level comStatus field signals will flag the comStatus and masterStatus flags in the BITstatus field. Any asserted bits in this field imply that the corresponding comStatus field signal, if asserted, will cause the comStatus and masterStatus flags to be asserted in the BITstatus field.

softwareStatusEnable Field

This field is a bit mask of the softwareStatus field (see BIT and status definitions). This field allows the user to determine which low level softwareStatus field signals will flag the softwareStatus and masterStatus flags in the BITstatus field. Any asserted bits in this field imply that the corresponding softwareStatus field signal, if asserted, will cause the softwareStatus and masterStatus flags to be asserted in the BITstatus field. sensorStatusEnable Field



This field is a bit mask of the sensorStatus field (see BIT and status definitions). This field allows the user to determine which low level sensorStatus field signals will flag the sensorStatus and masterStatus flags in the BITstatus field. Any asserted bits in this field imply that the corresponding sensorStatus field signal, if asserted, will cause the sensorStatus and masterStatus flags to be asserted in the BITstatus field.

单击下面可查看定价，库存，交付和生命周期等信息

[>>ACEINNA\(新纳\)](#)