

AIT CONNECTOR

Board-to-wire/Wire-to-wire

Features

- Compliant with the Standard 0.64 Unsealed USCAR Footprints and USCAR Performance Standards
- Variations in PCB mountings

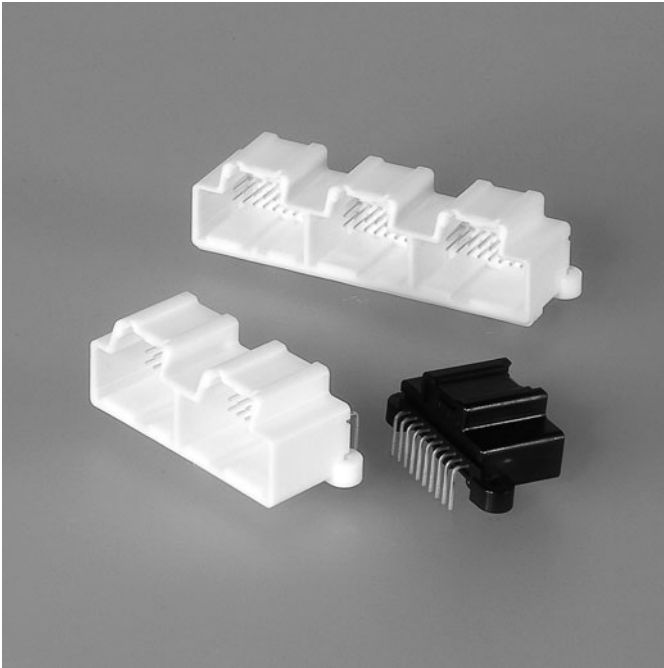

0.64 unsealed connector series compliant with the standard USCAR footprints.
Variations of Keying / Color options and PC Board mounting features are available to satisfy customer's needs.

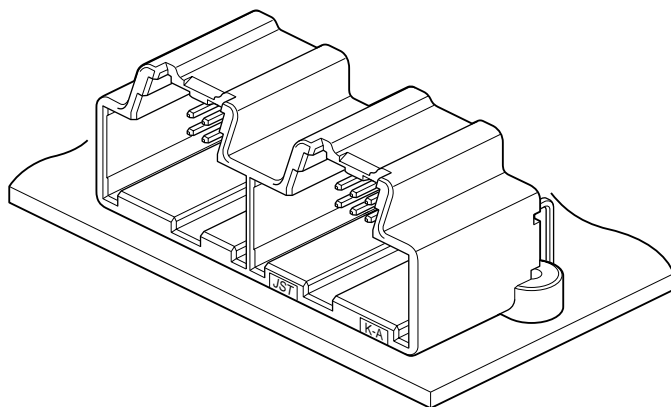

Specifications

- Current rating: 5A DC max.
- Voltage rating: 14V DC
- Temperature range: -40°C to +100°C
(including temperature rise in applying electrical current)
- Contact resistance: Initial value/15mΩ max.
After environmental testing/15mΩ max.
- Insulation resistance: 100MΩ min.
- Applicable Wire: SAE/ AVSS / CAVS
0.3mm² to 0.8mm²

* Compliant with ELV/RoHS.
* Contact JST for details.

Female terminal

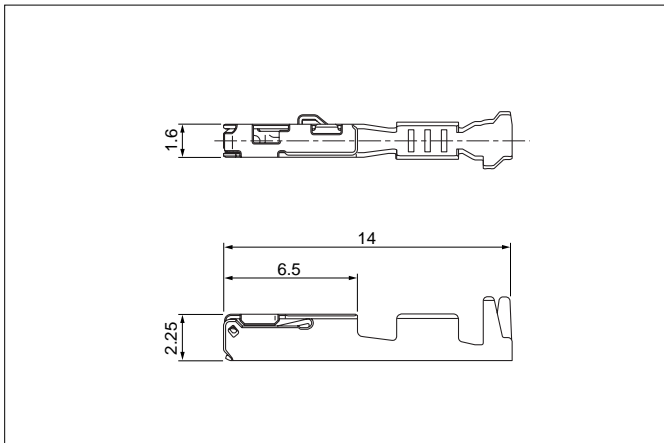

Size	Model No.	Applicable wire range		Q'ty/reel
		Conductor (mm ²)	Insulation O.D. (mm)	
S	①SAIT-A03T-M064	0.3 to 0.5	≤1.9	6,500
	②SAIT-A03GF-M064	0.3 to 0.5	≤1.9	6,500
M	①SAIT-A02T-M064	0.75 to 0.8	≤1.9	6,500
	②SAIT-A02GF-M064	0.75 to 0.8	≤1.9	6,500

Material and Finish

- ①Copper alloy, tin-plated (reflow treatment)
- ②Copper alloy, Contact area; gold-plated
Barrel area; tin-plated

Male terminal

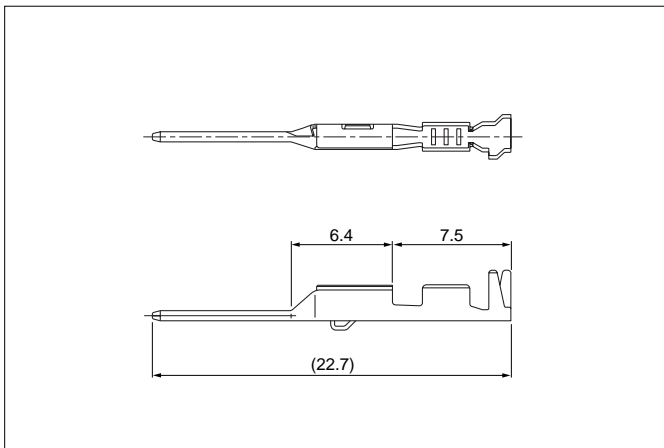

Size	Model No.	Applicable wire range		Q'ty/reel
		Conductor (mm ²)	Insulation O.D. (mm)	
S	①SAITW-A03T-064	0.3 to 0.5	≤1.9	7,000
	②SAITW-A03GF-064	0.3 to 0.5	≤1.9	7,000
M	①SAITW-A02T-064	0.75 to 0.8	≤1.9	7,000
	②SAITW-A02GF-064	0.75 to 0.8	≤1.9	7,000

Material and Finish

- ①Brass, tin-plated (reflow treatment)
- ②Brass, Contact area; gold-plated
Barrel area; tin-plated

Male connector

Top entry type

With boss

● 20 circuits

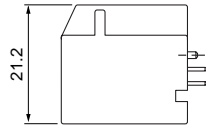
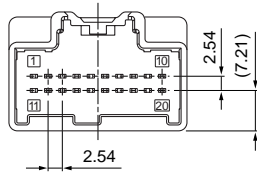
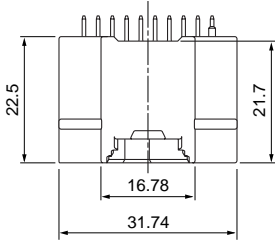

Screw hole type

● 8 circuits

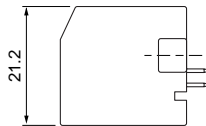
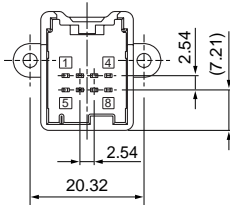
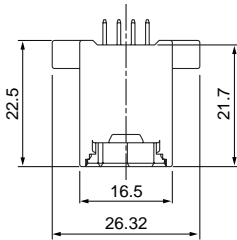

● 16 circuits

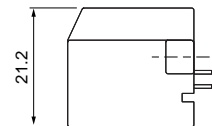
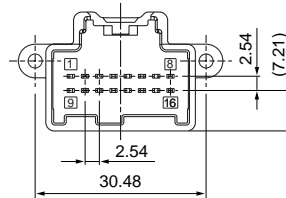
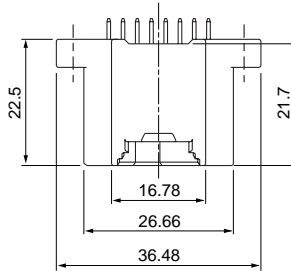

● 18 circuits

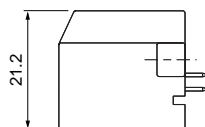
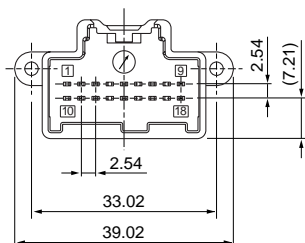
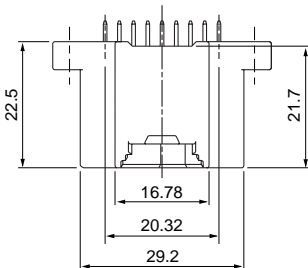

Circuits	Model No.	Q'ty/box	Housing Color
8	B08B-AIT-A2B-HS	96	Gray
	B08B-AIT-A2A-KS	96	Black
16	B16B-AIT-A2A-KS	60	Black
	B16B-AIT-A2B-HS	60	Gray
18	B18B-AIT-A2F-SS	60	Natural (White)
20	B20B2-AIT-A2A-KS-(M)	510	Black
	B20B2-AIT-A2C-KS-(M)	510	Brown

Material and Finish

Housing: Glass-filled PA
Pin: Brass, tin-plated

Male connector

Side entry type

● 34 circuits

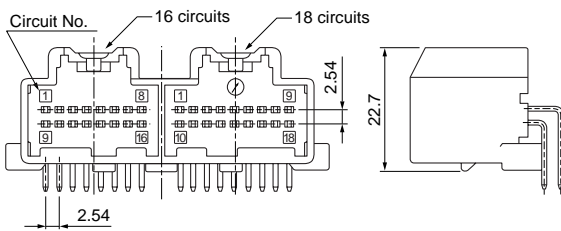
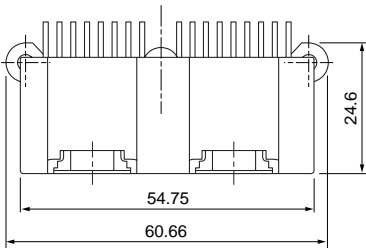

● 52 circuits

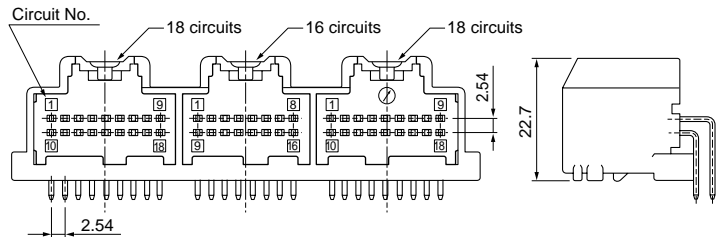
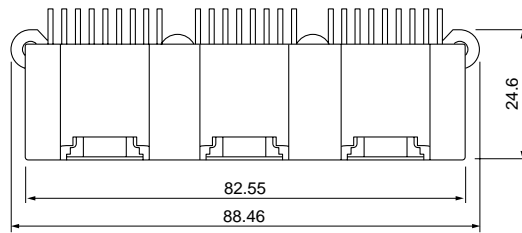

Screw hole type

● 10 circuits

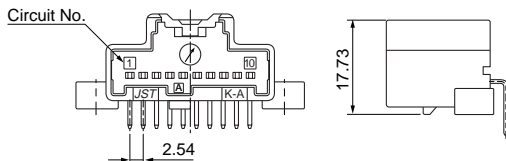
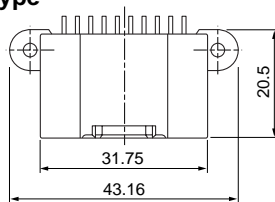

● 20 circuits

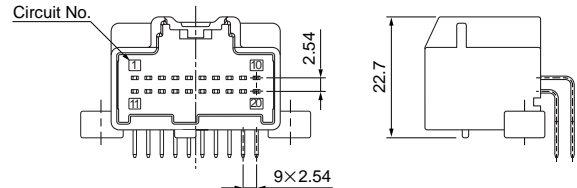
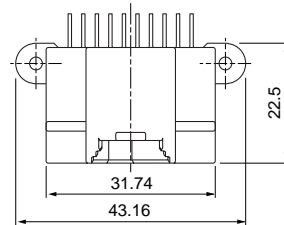

Reinforcement type

● 4 circuits

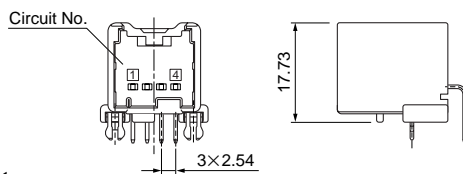
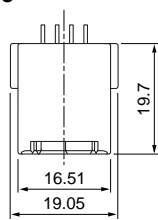

● 8 circuits

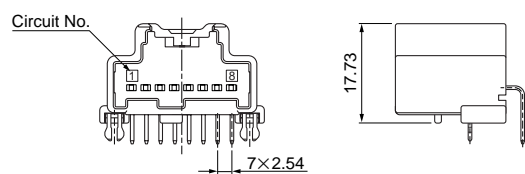
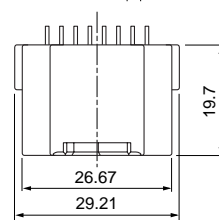

● 20 circuits

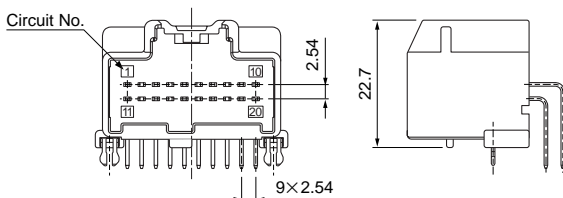
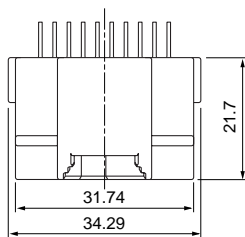

Type	Circuits	Model No.	Q'ty/box	Housing Color
1 Block	4	S04B1-AIT-A1A-KS	88	Black
	8	S08B1-AIT-A1A-KS	56	Black
	10	*S10B-AIT-A1A-KS-(M)	390	Black
	20	S20B-AIT-A2B-HS	24	Gray
		S20B-AIT-A2A-KS	24	Black
		S20B1-AIT-A2A-KS	36	Black
	S20B1-AIT-A2B-HS	36	Gray	
2 Block	34	*S34B-AIT-A22-SS-(M)	216	Natural (White)
3 Block	52	*S52B-AIT-A23-SS-(M)	144	Natural (White)

Material and Finish

Housing: Glass-filled PBT

Pin: Brass, tin-plated

splay (LF)(SN) on a label.

AIT CONNECTOR

Male connector

● 10 circuits

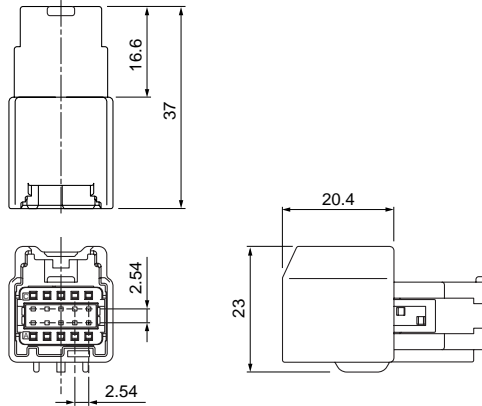

Circuits	Model No.	Q'ty/box
10	AITWSB-10-2AK	100
Material		
Housing: Glass-filled PBT, black		
TPA: Glass-filled PBT, red		

PC board layout

Top entry type

With boss

● 20 circuits

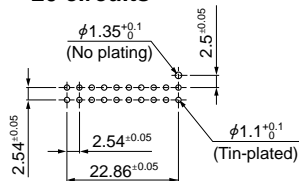

Screw hole type

● 8 circuits

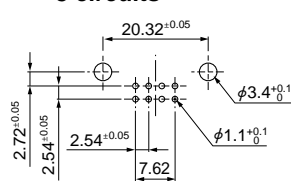

● 16 circuits

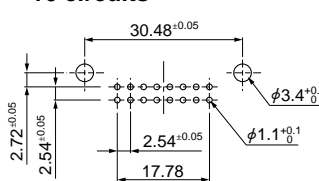

● 18 circuits

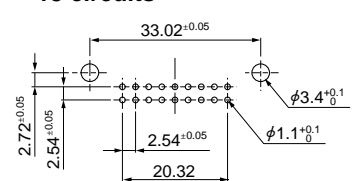

Side entry type

● 34 circuits

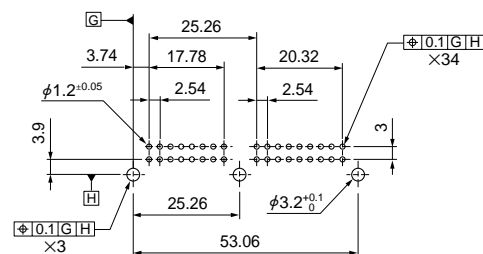

Screw hole type

● 10 circuits

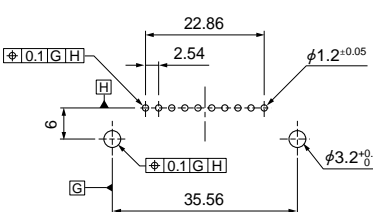

● 20 circuits

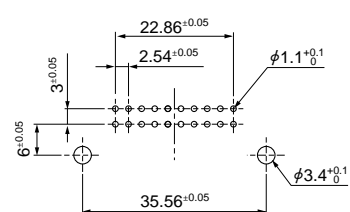

● 52 circuits

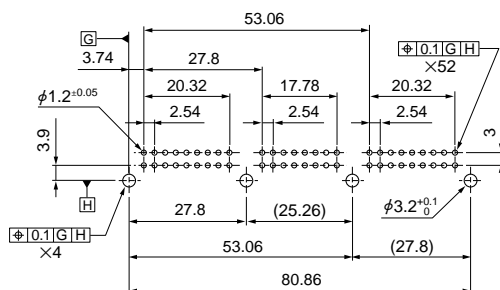

Reinforcement type

● 4 circuits

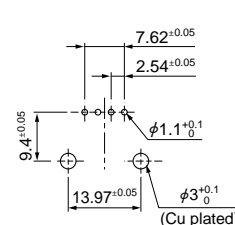

● 8 circuits

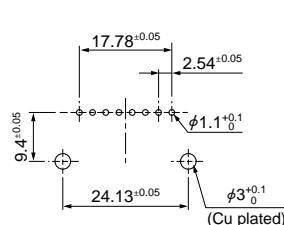

● 20 circuits

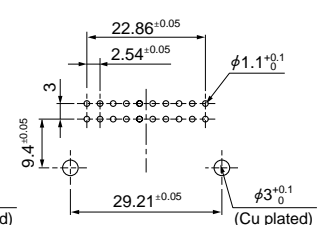

Note: 1. Tolerances are non-cumulative.
 2. Hole dimensions differ according to the type of PC board and piercing method.
 The dimensions above should serve as guideline. Contact JST for details.

Crimping machine, Applicator

Strip terminal	Crimping machine	Crimp applicator MKS-L	
		Dies	Crimp applicator with dies
SAIT-A03(-)-M064	AP-K2N	MK/SAIT-A03-064	APLMK SAIT-A03-064
SAIT-A02(-)-M064		MK/SAIT-A02-064	APLMK SAIT-A02-064
SAITW-A03(-)-064		MK/SAITW-A03-064	APLMK SAITW-A03-064
SAITW-A02(-)-064		MK/SAITW-A02-064	APLMK SAITW-A02-064

Note: When crimping operation is conducted using an applicator and die set other than the above, JST cannot guarantee the performance of the terminal.

单击下面可查看定价，库存，交付和生命周期等信息

[>>JST\(日本压着端子製造株式会社\)](#)