

## VDR Metal Oxide Varistors Standard



### ADDITIONAL RESOURCES



3D Models



Design Tools



Models

QUICK REFERENCE DATA		
PARAMETER	VALUE	UNIT
Maximum continuous voltage in operating temperature range:		
RMS	14 to 680	V
DC	18 to 895	V
Maximum non-repetitive transient current $I_{NRP}$ (8 x 20 $\mu$ s)	100 to 6500	A
Maximum energy (10/1000 $\mu$ s)	0.5 to 496	J
Detailed specification	Based on IEC 61051-1 IEC 61051-2 IEC 61051-2-2	
Storage temperature	-40 to +125	°C
Operating temperature	-40 to +85	°C

### ORDERING INFORMATION

The varistors are available in a number of packaging options:

- Bulk
- On tape and reel
- On tape in ammpack (fanfold)

The basic ordering code for each option is given in tables titled Varistors on Tape on Reel, Varistors on Tape in Ammpack and Varistors in Bulk. To complete the catalog number and to determine the required operating parameters, see Electrical Data and Ordering Information table.

#### Note

- Special lead-configuration as inside or outside crimped leads on request

### AGENCY APPROVALS

- cUL certificate
- ULus certificate
- VDE certificate

#### Note

- Agency approval documents, please see: [www.vishay.com/varistors/list/product-29081/tab/documents/](http://www.vishay.com/varistors/list/product-29081/tab/documents/)

### FEATURES

- Low  $\beta$  high purity zinc oxide disc
- Halogen free insulating epoxy coating
- Straight leads and kinked leads
- Straight leads with flange (VDRS05 and VDRS07 only)
- Certified for operation up to 85 °C according to UL 1449 edition 4, VDE/IEC 61051-1/2
- Material categorization: for definitions of compliance please see [www.vishay.com/doc?99912](http://www.vishay.com/doc?99912)

**RoHS**  
COMPLIANT  
HALOGEN  
**FREE**

### APPLICATION

- Overvoltage and transient voltage protection

### DESCRIPTION

The varistors consist of a disc of low- $\beta$  ZnO ceramic material with two solid copper leads (S20 types only) or copper clad steel wire. The wires have a matte tin plating. They are coated with UL 94 V-0 approved ochre colored halogen-free epoxy, which provides electrical, mechanical and climatic protection.

### MOUNTING

The varistors are suitable for hand-mounting (bulk) or automatic pick and place mounting (tape on reel or fanfold). The parts can be soldered by hand or wave soldering. Pin-in-paste reflow soldering is not recommended. Bending of the leads for different angle placement is not recommended.

#### Typical soldering

235 °C, duration: 5 s (Pb-bearing)

245 °C, duration: 5 s (lead (Pb)-free)

#### Resistance to soldering heat

260 °C, duration: 10 s max.

### MARKING

The varistors are marked with the following information:

- Maximum continuous RMS voltage
- Series numbers
  - 592 for VDRS05
  - 593 for VDRS07
  - 594 for VDRS10
  - 595 for VDRS14
  - 596 for VDRS20
- Safety marks on VDRS10-14-20 types
- Manufacturers logo
- Date of manufacture (YYWW)

### INFLAMMABILITY

The varistors are passive non-flammable.

The encapsulation is made of flammable resistant epoxy in accordance with UL 94 V-0.



**ELECTRICAL DATA AND ORDERING INFORMATION**

MAXIMUM CONTINUOUS VOLTAGE		VOLTAGE AT 1 mA <sup>(3)</sup>	MAXIMUM VOLTAGE AT STATED CURRENT		MAXIMUM ENERGY <sup>(4)</sup> (10 x 1000 µs)	MAXIMUM NON-REP. TRANSIENT CURRENT <sup>(5)</sup> I <sub>NRP</sub> (8 x 20 µs)	NOMINAL DISCHARGE CURRENT <sup>(7)</sup> I <sub>N</sub>	TYPICAL CAPACITANCE AT 1 kHz	T (max.)	E	SAP MATERIAL AND ORDERING NUMBER <sup>(1)</sup> xy <sup>(6)</sup>
RMS <sup>(2)</sup> (V)	DC (V)	(V)	V (V)	I (A)	(J)	(A)	(kA)	(pF)	(mm)	(mm)	
14	18	22	48	1.0	0.5	100	0.10	1300	4.1	0.7 ± 0.3	VDRS05A014xyE
			43	2.5	1.7	250	0.15	2800	4.1	0.7 ± 0.3	VDRS07B014xyE
			43	5.0	4.3	500	0.25	6000	4.4	0.9 ± 0.3	VDRS10D014xyE
			43	10.0	5.4	1000	1.00	15 000	4.4	0.9 ± 0.3	VDRS14G014xyE
			43	20.0	8.0	2000	2.00	30 000	4.6	1.1 ± 0.3	VDRS20M014ByE
17	22	27	60	1.0	0.7	100	0.10	1050	4.1	0.8 ± 0.3	VDRS05A017xyE
			53	2.5	2.0	250	0.15	2000	4.1	0.8 ± 0.3	VDRS07B017xyE
			53	5.0	5.3	500	0.25	4000	4.4	1.0 ± 0.3	VDRS10D017xyE
			53	10.0	6.9	1000	1.00	10 000	4.4	1.0 ± 0.3	VDRS14G017xyE
			53	20.0	10.0	2000	2.00	20 000	4.6	1.2 ± 0.3	VDRS20M017ByE
20	26	33	73	1.0	0.8	100	0.10	900	4.1	1.0 ± 0.3	VDRS05A020xyE
			65	2.5	2.5	250	0.15	1500	4.1	1.0 ± 0.3	VDRS07B020xyE
			65	5.0	6.5	500	0.25	3000	4.4	1.2 ± 0.3	VDRS10D020xyE
			65	10.0	8.8	1000	1.00	7500	4.4	1.2 ± 0.3	VDRS14G020xyE
			65	20.0	12.0	2000	2.00	15 000	4.8	1.4 ± 0.3	VDRS20M020ByE
25	31	39	86	1.0	0.9	100	0.10	500	4.2	1.2 ± 0.3	VDRS05A025xyE
			77	2.5	3.0	250	0.15	1350	4.2	1.2 ± 0.3	VDRS07B025xyE
			77	5.0	7.7	500	0.25	2600	4.6	1.4 ± 0.3	VDRS10D025xyE
			77	10.0	9.4	1000	1.00	6500	4.6	1.4 ± 0.3	VDRS14G025xyE
			77	20.0	14.0	2000	2.00	13 000	5.0	1.6 ± 0.3	VDRS20M025ByE
30	38	47	96	1.0	1.1	100	0.10	700	4.4	1.4 ± 0.5	VDRS05A030xyE
			93	2.5	3.6	250	0.15	1600	4.4	1.4 ± 0.5	VDRS07B030xyE
			93	5.0	9.2	500	0.25	2700	4.8	1.6 ± 0.5	VDRS10D030xyE
			93	10.0	12.0	1000	1.00	6000	4.8	1.6 ± 0.5	VDRS14G030xyE
			93	20.0	17.0	2000	2.00	12 000	5.2	1.8 ± 0.5	VDRS20M030ByE
35	45	56	123	1.0	1.4	100	0.10	560	4.8	1.7 ± 0.5	VDRS05A035xyE
			110	2.5	4.4	250	0.15	1300	4.8	1.7 ± 0.5	VDRS07B035xyE
			110	5.0	11.0	500	0.25	2200	5.2	1.9 ± 0.5	VDRS10D035xyE
			110	10.0	14.0	1000	1.00	4800	5.2	1.9 ± 0.5	VDRS14G035xyE
			110	20.0	20.0	2000	2.00	9600	5.6	2.1 ± 0.5	VDRS20M035ByE
40	56	68	145	1.0	1.6	100	0.10	460	5.1	2.1 ± 0.5	VDRS05A040xyE
			135	2.5	5.2	250	0.15	1000	5.1	2.1 ± 0.5	VDRS07B040xyE
			135	5.0	13.0	500	0.25	1800	5.5	2.3 ± 0.5	VDRS10D040xyE
			135	10.0	17.0	1000	1.00	3800	5.5	2.3 ± 0.5	VDRS14G040xyE
			135	20.0	24.0	2000	2.00	7600	5.9	2.5 ± 0.5	VDRS20M040ByE
50	65	82	145	5.0	2.6	400	0.10	370	4.1	0.6 ± 0.3	VDRS05C050xyE
			140	10.0	7.0	1200	0.50	900	4.1	0.6 ± 0.3	VDRS07H050xyE
			140	25.0	12.0	2500	1.50	1500	4.4	0.8 ± 0.3	VDRS10P050xyE
			140	50.0	21.0	4500	3.00	3100	4.4	0.8 ± 0.3	VDRS14T050xyE
			170	5.0	2.9	400	0.10	290	4.1	0.7 ± 0.3	VDRS05C060xyE
60	85	100	165	10.0	8.3	1200	0.50	700	4.1	0.7 ± 0.3	VDRS07H060xyE
			165	25.0	15.0	2500	1.50	1200	4.4	0.9 ± 0.3	VDRS10P060xyE
			165	50.0	24.0	4500	3.00	2300	4.4	0.9 ± 0.3	VDRS14T060xyE
			165	100.0	56.0	6500	3.00	4700	4.5	1.1 ± 0.3	VDRS20W060ByE
			210	5.0	3.4	400	0.10	240	4.1	0.9 ± 0.3	VDRS05C075xyE
75	100	120	200	10.0	10.0	1200	0.50	530	4.1	0.9 ± 0.3	VDRS07H075xyE
			200	25.0	18.0	2500	1.50	1000	4.4	1.1 ± 0.3	VDRS10P075xyE
			200	50.0	29.0	4500	3.00	1900	4.4	1.1 ± 0.3	VDRS14T075xyE
			200	100.0	64.0	6500	3.00	3900	4.8	1.3 ± 0.3	VDRS20W075ByE
			250	5.0	4.1	400	0.10	180	4.2	1.1 ± 0.3	VDRS05C095xyE
95	125	150	250	10.0	13.0	1200	0.50	450	4.2	1.1 ± 0.3	VDRS07H095xyE
			250	25.0	22.0	2500	1.50	800	4.6	1.3 ± 0.3	VDRS10P095xyE
			250	50.0	37.0	4500	3.00	1500	4.6	1.3 ± 0.3	VDRS14T095xyE
			250	100.0	88.0	6500	3.00	3000	5.2	1.5 ± 0.3	VDRS20W095ByE



ELECTRICAL DATA AND ORDERING INFORMATION											
MAXIMUM CONTINUOUS VOLTAGE		VOLTAGE <sup>(3)</sup> AT 1 mA	MAXIMUM VOLTAGE AT STATED CURRENT		MAXIMUM ENERGY <sup>(4)</sup> (10 x 1000 µs)	MAXIMUM NON-REP. TRANSIENT CURRENT <sup>(5)</sup> I <sub>NRP</sub> (8 x 20 µs)	NOMINAL DISCHARGE CURRENT <sup>(7)</sup> I <sub>N</sub>	TYPICAL CAPACITANCE AT 1 kHz	T (max.)	E	SAP MATERIAL AND ORDERING NUMBER <sup>(1)</sup> xy <sup>(6)</sup>
RMS <sup>(2)</sup> (V)	DC (V)	(V)	V (V)	I (A)	(J)	(A)	(kA)	(pF)	(mm)	(mm)	
130	170	205	345	5.0	5.5	400	0.10	130	4.2	1.0 ± 0.3	VDRS05C130xyE
			340	10.0	17.0	1200	0.50	320	4.2	1.0 ± 0.3	VDRS07H130xyE
			340	25.0	30.0	2500	1.50	580	4.6	1.2 ± 0.3	VDRS10P130xyE
			340	50.0	56.0	4500	3.00	1050	4.6	1.2 ± 0.3	VDRS14T130xyE
			340	100.0	114.0	6500	3.00	2100	5.3	1.4 ± 0.3	VDRS20W130ByE
140	180	220	380	5.0	6.3	400	0.10	120	4.4	1.0 ± 0.3	VDRS05C140xyE
			360	10.0	21.0	1200	0.50	290	4.4	1.0 ± 0.3	VDRS07H140xyE
			360	25.0	33.0	2500	1.50	540	4.8	1.2 ± 0.3	VDRS10P140xyE
			360	50.0	57.0	4500	3.00	950	4.8	1.2 ± 0.3	VDRS14T140xyE
			360	100.0	124.0	6500	3.00	1900	5.4	1.5 ± 0.3	VDRS20W140ByE
150	200	240	400	5.0	7.1	400	0.10	110	4.4	1.1 ± 0.3	VDRS05C150xyE
			395	10.0	20.0	1200	0.50	270	4.4	1.1 ± 0.3	VDRS07H150xyE
			395	25.0	36.0	2500	1.50	490	4.8	1.3 ± 0.3	VDRS10P150xyE
			395	50.0	59.0	4500	3.00	850	4.8	1.3 ± 0.3	VDRS14T150xyE
			395	100.0	134.0	6500	3.00	1700	5.5	1.6 ± 0.3	VDRS20W150ByE
175	225	275	455	5.0	7.3	400	0.10	90	4.6	1.3 ± 0.3	VDRS05C175xyE
			455	10.0	23.0	1200	0.50	230	4.6	1.3 ± 0.3	VDRS07H175xyE
			455	25.0	41.0	2500	1.50	430	5.0	1.5 ± 0.3	VDRS10P175xyE
			455	50.0	67.0	4500	3.00	750	5.0	1.5 ± 0.3	VDRS14T175xyE
			455	100.0	158.0	6500	3.00	1500	5.7	1.7 ± 0.3	VDRS20W175ByE
230	300	360	600	5.0	10.0	400	0.10	70	4.9	1.7 ± 0.8	VDRS05C230xyE
			595	10.0	30.0	1200	0.50	170	4.9	1.7 ± 0.8	VDRS07H230xyE
			595	25.0	54.0	2500	1.50	320	5.4	1.9 ± 0.8	VDRS10P230xyE
			595	50.0	88.0	4500	3.00	540	5.4	1.9 ± 0.8	VDRS14T230xyE
			595	100.0	208.0	6500	3.00	1100	6.2	2.2 ± 0.8	VDRS20W230ByE
250	320	390	650	5.0	11.0	400	0.10	60	4.9	1.9 ± 0.8	VDRS05C250xyE
			650	10.0	33.0	1200	0.50	160	4.9	1.9 ± 0.8	VDRS07H250xyE
			650	25.0	58.0	2500	1.50	300	5.4	2.1 ± 0.8	VDRS10P250xyE
			650	50.0	96.0	4500	3.00	480	5.4	2.1 ± 0.8	VDRS14T250xyE
			650	100.0	240.0	6500	3.00	960	6.4	2.3 ± 0.8	VDRS20W250ByE
275	350	430	710	5.0	12.0	400	0.10	55	4.9	2.0 ± 0.8	VDRS05C275xyE
			710	10.0	36.0	1200	0.50	140	4.9	2.0 ± 0.8	VDRS07H275xyE
			710	25.0	63.0	2500	1.50	270	5.4	2.2 ± 0.8	VDRS10P275xyE
			710	50.0	104.0	4500	3.00	440	5.4	2.2 ± 0.8	VDRS14T275xyE
			710	100.0	264.0	6500	3.00	900	6.6	2.5 ± 0.8	VDRS20W275ByE
300	385	470	800	5.0	13.0	400	0.10	50	5.3	2.2 ± 0.8	VDRS05C300xyE
			775	10.0	40.0	1200	0.50	130	5.3	2.2 ± 0.8	VDRS07H300xyE
			775	25.0	71.0	2500	1.50	240	5.9	2.4 ± 0.8	VDRS10P300xyE
			775	50.0	117.0	4500	3.00	400	5.9	2.4 ± 0.8	VDRS14T300xyE
			775	100.0	280.0	6500	3.00	810	6.9	2.7 ± 0.8	VDRS20W300ByE
320	420	510	850	5.0	15.0	400	0.10	45	5.5	2.4 ± 0.8	VDRS05C320xyE
			842	10.0	44.0	1200	0.50	120	5.5	2.4 ± 0.8	VDRS07H320xyE
			842	25.0	77.0	2500	1.50	220	6.2	2.6 ± 0.8	VDRS10P320xyE
			842	50.0	120.0	4500	3.00	370	6.2	2.6 ± 0.8	VDRS14T320xyE
			842	100.0	296.0	6500	3.00	750	7.1	2.9 ± 0.8	VDRS20W320ByE
350	460	560	940	5.0	19.5	400	0.10	42	5.8	2.7 ± 0.8	VDRS05C350xyE
			920	10.0	39.0	1200	0.50	110	5.8	2.7 ± 0.8	VDRS07H350xyE
			920	25.0	78.0	2500	1.50	200	6.6	2.9 ± 0.8	VDRS10P350xyE
			920	50.0	156.0	4500	3.00	325	6.6	2.9 ± 0.8	VDRS14T350xyE
			920	100.0	312.0	6500	3.00	660	7.4	3.2 ± 0.8	VDRS20W350ByE
385	505	620	1025	5.0	18.0	400	0.10	40	6.0	3.0 ± 0.8	VDRS05C385xyE
			1025	10.0	51.0	1200	0.50	95	6.0	3.0 ± 0.8	VDRS07H385xyE
			1025	25.0	67.0	2500	1.50	180	6.6	3.2 ± 0.8	VDRS10P385xyE
			1025	50.0	110.0	4500	3.00	280	6.6	3.2 ± 0.8	VDRS14T385xyE
			1025	100.0	328.0	6500	3.00	570	7.7	3.5 ± 0.8	VDRS20W385ByE



ELECTRICAL DATA AND ORDERING INFORMATION

Table with columns: MAXIMUM CONTINUOUS VOLTAGE (RMS, DC), VOLTAGE AT 1 mA, MAXIMUM VOLTAGE AT STATED CURRENT (V, I), MAXIMUM ENERGY (10 x 1000 μs) (J), MAXIMUM NON-REP. TRANSIENT CURRENT (I\_NRP) (A), NOMINAL DISCHARGE CURRENT (I\_N) (kA), TYPICAL CAPACITANCE AT 1 kHz (pF), T (max.) (mm), E (mm), SAP MATERIAL AND ORDERING NUMBER (xy).

Notes

- (1) The products are certified according to cULus (E332800), and VDE/IEC (40002622). See Agency Approval section for certificate download
(2) The sinusoidal voltage is assumed as the normal operating condition. If a non-sinusoidal voltage is present, type selection should be based on multiplying the peak voltage by a factor of 0.707.
(3) The voltage measured at 1 mA meets the requirements of IEC 61051. The tolerance on the voltage at 1 mA is ± 10 %.
(4) High energy surges are generally of longer duration. The maximum energy for one pulse of 10 x 1000 μs is given as a reference for longer duration pulses. This pulse can be characterized by peak current (I\_p) and pulse width t\_2 (virtual time of half I\_p value, following IEC 60060-2, section 6). If V\_p is the clamping voltage corresponding to I\_p, the energy absorbed in the varistor is determined by the formula: E = K x V\_p x I\_p x t\_2
(5) A current wave of 8 x 20 μs is used as a standard for pulse current and clamping voltage ratings. The maximum non-repetitive transient current is given for one pulse applied during the life of the component.
(6) For composition of the SAP part number: Replace "x" by B for bulk type, T for tape and reel, A for tape and ammpack; Replace "y" by S for straight leads, F for straight leads with flange (bulk only), G for straight leads with flange and H\_0 = 16 mm (tape and reel/ammo), H for straight leads with flange and H\_0 = 18.25 mm (tape and reel/ammo), K for kinked leads (bulk only), L for kinked leads with H\_0 = 16 mm (tape and reel/ammo), M for kinked leads with H\_0 = 18.25 mm (tape and reel/ammo)
(7) All varistors are UL 1449 edition 4 recognized as SPD type 5 (component level) for operating temperatures up to 85 °C. The varistors may be used in other SPD types as 2, 3, or 4 depending on the indicated I\_N nominal discharge current ratings. The final acceptance of the component is dependent upon its installation and use in complete equipment submitted to underwriters laboratories Inc.



**ELECTRICAL CHARACTERISTICS**

ELECTRICAL DATA		
PARAMETER	VALUE	UNIT
Maximum continuous voltage:		
RMS	14 to 680	V
DC	18 to 895	V
Maximum non-repetitive transient current ( $I_{NRP}$ ) ( $8 \times 20 \mu s$ )		
VDRS05	100 or 400	A
VDRS07	250 or 1200	A
VDRS10	500 or 2500	A
VDRS14	1000 or 4500	A
VDRS20	2000 or 6500	A
Thermal resistance:		
VDRS05	$\approx 80$	K/W
VDRS07	$\approx 70$	K/W
VDRS10	$\approx 60$	K/W
VDRS14	$\approx 50$	K/W
VDRS20	$\approx 40$	K/W
Maximum dissipation:		
VDRS05	100	mW
VDRS07	250	mW
VDRS10	400	mW
VDRS14	600	mW
VDRS20	1000	mW
Temperature coefficient of voltage at 1 mA maximum	$\pm 0.05$	%/K
Voltage proof between interconnected leads and case	2500	V <sub>AC</sub>
Storage temperature	-40 to +125	°C
Operating temperature	-40 to +85	°C

**DERATING CURVE**

Maximum Voltage  
Maximum Dissipation  
Maximum Energy  
Maximum Transient Current

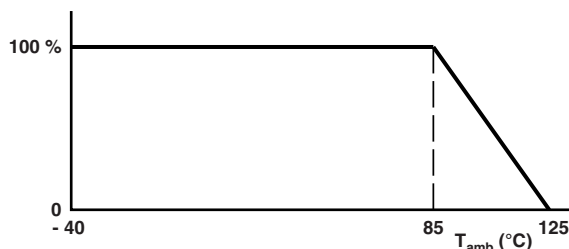

**PEAK CURRENT AS A FUNCTION OF PULSE WIDTH**

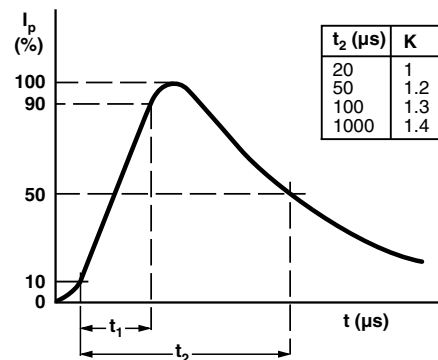

**COMPONENT DIMENSIONS (BULK TYPE) in millimeters AND CATALOG NUMBERS**

D MAX.		A MAX.		A <sub>0</sub> MAX.		L MIN.	T <sup>(1)</sup> MAX.	E <sup>(1)</sup>	d	F	CATALOG NUMBER
V ≤ 320 V	V > 320 V	V ≤ 300 V	V > 300 V	V ≤ 320 V	V > 320 V						
7.0		9.0		11.0		24.0	6.5	0.7 to 3.6	0.6 ± 0.05	5 ± 1.0	VDRS05
9.0		11.0		13.0		24.0	6.5	0.7 to 3.6	0.6 ± 0.05	5 ± 1.0	VDRS07
12.0	12.5	14.5	15.0	16.5	17.0	17.0	8.0	0.9 to 4.5	0.8 ± 0.05	7.5 ± 1.0	VDRS10
16.0	16.5	19.0		21.0	21.5	16.0	8.0	0.9 to 4.5	0.8 ± 0.05	7.5 ± 1.0	VDRS14
22.5	23.0	25.5		27.5	28.0	24.0	10.0	1.1 to 5.8	1.0 ± 0.05	10 ± 1.0	VDRS20

**Note**

<sup>(1)</sup>  $T_{max}$ , and E values per size and voltage level can be found back in the Electrical Data and Ordering Information table

VARISTORS IN BULK					
TYPE	VDRS05... Ø 5 mm 14 V to 460 V	VDRS07... Ø 7 mm 14 V to 460 V	VDRS10... Ø 10 mm 14 V to 550 V	VDRS14... Ø 14 mm 14 V to 550 V	VDRS20... Ø 20 mm 14 V to 680 V
Straight leads; see outline of components with straight leads drawing <sup>(1)</sup>	BSE	BSE	BSE	BSE	BSE
Straight leads with flange; see outline of components with flanged leads drawing	BFE	BFE	-	-	-
Kinked leads; see outline of components with kinked leads drawing	BKE	BKE	BKE	BKE	BKE
<b>Packaging quantities</b>					
14 V to 95 V	250	250	250	100	50
130 V to 385 V	250	250	250	100	50
420 V to 460 V	250	250	200	100	50
485 V to max. V	-	250	150	100	50

**Note**

<sup>(1)</sup> Outline of the Ø 20 mm differs from the other dimensions

**DIMENSIONS** in millimeters: see Component Dimensions and Electrical Data table

**OUTLINE** of Component with Straight Leads



**OUTLINE** of Component with Kinked Leads

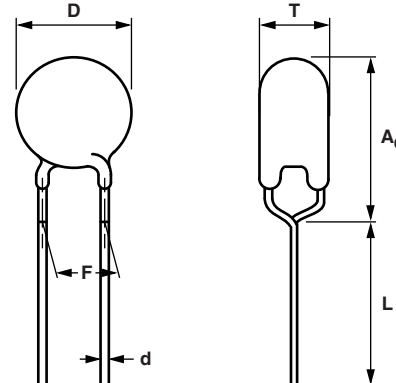

**OUTLINE** of Component with Flanged Leads

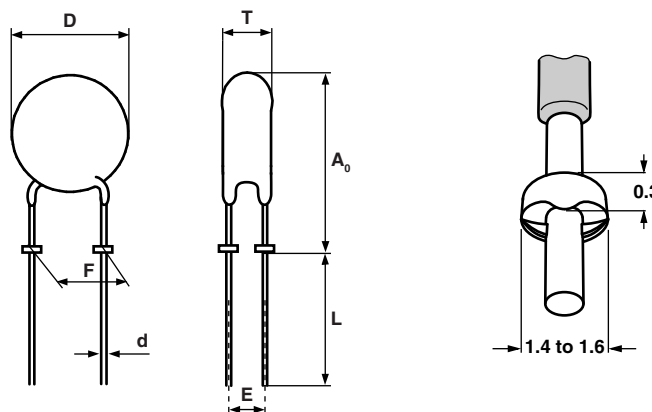

<b>VARISTORS ON TAPE IN AMMOPACK</b>				
<b>TYPE</b>	<b>VDRS05... Ø 5 mm 14 V to 460 V</b>	<b>VDRS07... Ø 7 mm 14 V to 460 V</b>	<b>VDRS10... Ø 10 mm 14 V to 550 V</b>	<b>VDRS14... Ø 14 mm 14 V to 550 V</b>
Straight leads H = 18 mm H = 20 mm See drawing: taped version with straight leads	- ASE	- ASE	ASE -	ASE -
Straight leads with flange H <sub>0</sub> = 16 mm H <sub>0</sub> = 18.25 mm See drawing: taped version with flanged leads	AGE AHE	AGE AHE	- -	- -
Kinked leads H <sub>0</sub> = 18.25 mm H <sub>0</sub> = 16 mm See drawing: taped version with kinked leads	AME ALE	AME ALE	AME ALE	AME ALE
<b>Packaging quantities</b>				
14 V to 210 V	1500 <sup>(1)</sup>	1500 <sup>(1)</sup>	500	500
230 V to 510 V	1000	1000	500	500
550 V	-	-	400	400

**Note**
<sup>(1)</sup> Except for 35 V and 40 V = 1000 pieces

**DIMENSIONS OF AMMOPACK** in millimeters

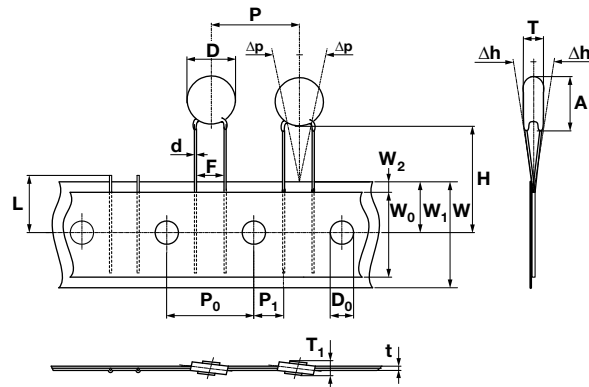
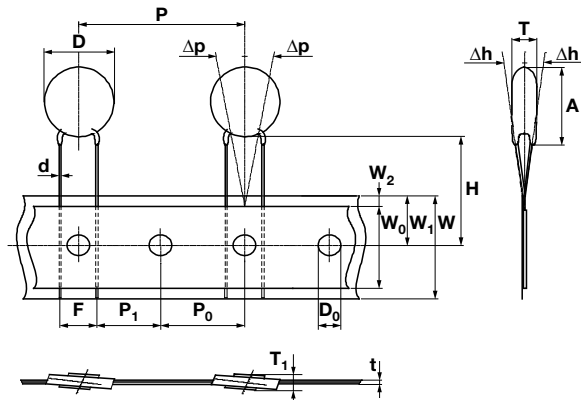

<b>VARISTORS ON TAPE AND REEL</b>				
<b>TYPE</b>	<b>VDRS05... Ø 5 mm 14 V to 460 V</b>	<b>VDRS07... Ø 7 mm 14 V to 460 V</b>	<b>VDRS10... Ø 10 mm 14 V to 550 V</b>	<b>VDRS14... Ø 14 mm 14 V to 550 V</b>
Straight leads H = 18 mm H = 20 mm See drawing: taped version with straight leads	- TSE	- TSE	TSE -	TSE -
Straight leads with flange H <sub>0</sub> = 16 mm H <sub>0</sub> = 18.25 mm See drawing: taped version with flanged leads	TGE THE	TGE THE	- -	- -
Kinked leads H <sub>0</sub> = 18.25 mm H <sub>0</sub> = 16 mm See drawing: taped version with kinked leads	TME TLE	TME TLE	TME TLE	TME TLE
<b>Packaging quantities</b>				
14 V to 250 V	1500	1500	1000	750
275 V to 300 V	1500	1500	750	750
320 V to 350 V	1000	1000	500	500
385 V to max. V	1000	1000	500	500

**PACKAGING**
**TAPED VERSION WITH STRAIGHT LEADS** (only for VDRS05 and VDRS07)

**TAPED VERSION WITH STRAIGHT LEADS** (only for VDRS10 and VDRS14)



### TAPED VERSION WITH KINKED LEADS

(only for VDRS05 and VDRS07)



### TAPED VERSION WITH KINKED LEADS

(only for VDRS10 and VDRS14)

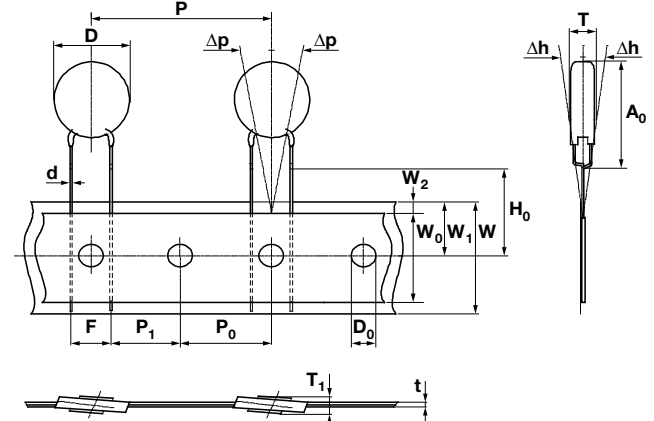

### TAPED VERSION WITH FLANGED LEADS

(only for VDRS05 and VDRS07)



### TAPING DATA (based on IEC 60286-2)

SYMBOL	PARAMETER	DIMENSIONS/TOLERANCE				
		VDRS05	VDRS07	VDRS10	VDRS14	
A max.	Max. mounting height	$V \leq 300\text{ V}$	9.0	11.0	14.5	19.0
		$V > 300\text{ V}$			15.0	
$A_0$ max.	Max. mounting height	$V \leq 320\text{ V}$	11.0	13.0	16.5	21.0
		$V > 320\text{ V}$			17.0	21.5
D max.	Max. body diameter	$V \leq 320\text{ V}$	7.0	9.0	12.0	16.0
		$V > 320\text{ V}$			12.5	16.5
d	Lead wire diameter	$0.6 \pm 0.05$		$0.8 \pm 0.05$		
F	Lead to lead distance <sup>(1)</sup>	$5.0 + 0.8/- 0.2$		$7.5 \pm 0.8$		
H	Distance component to tape center <sup>(2)</sup>	$20.0 + 2.0/- 0.0$		$18.0 + 2.0/- 0.0$		
$H_0$	Lead wire clinch height	$16.0$ or $18.25 \pm 0.5$				
P	Pitch of components on tape	$12.7 \pm 1.0$		$25.4 \pm 1.0$		
T	Total thickness	See Electrical Data table				

#### Notes

(1) Guaranteed between component and tape

(2) For VDRS14T510xSE and VDRS14T550xSE:  $H = 20\text{ mm} \pm 1\text{ mm}$



V/I CHARACTERISTICS

14 V<sub>RMS</sub> to 40 V<sub>RMS</sub>; VDRS05

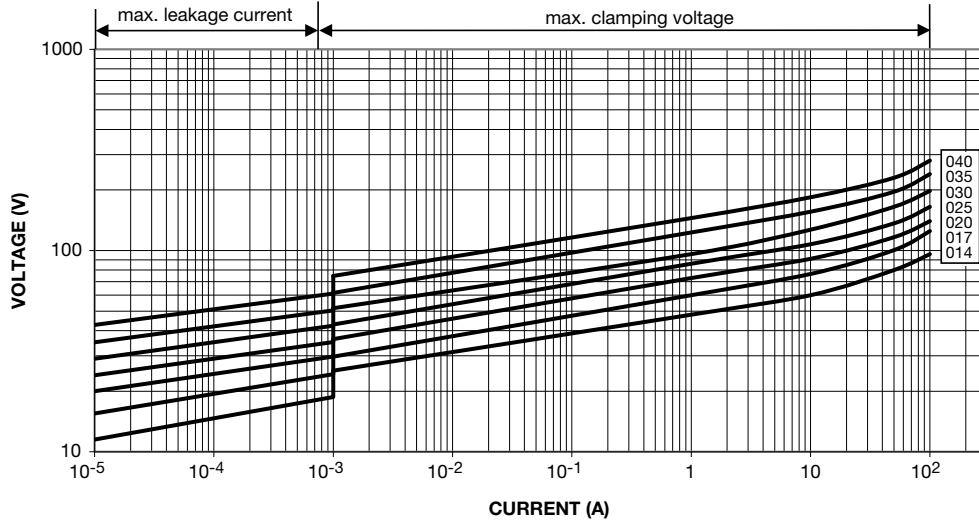

50 V<sub>RMS</sub> to 175 V<sub>RMS</sub>; VDRS05

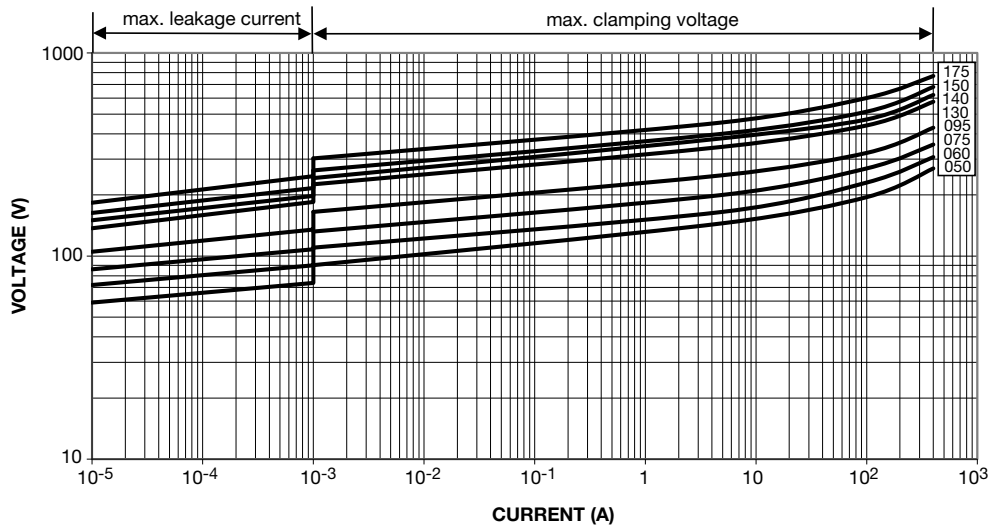

230 V<sub>RMS</sub> to 460 V<sub>RMS</sub>; VDRS05

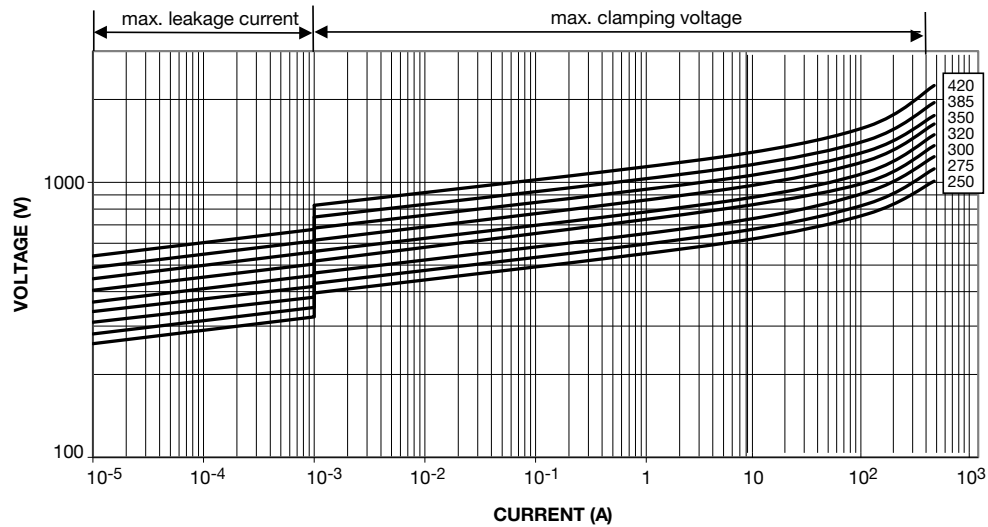



### 14 V<sub>RMS</sub> to 40 V<sub>RMS</sub>; VDRS07

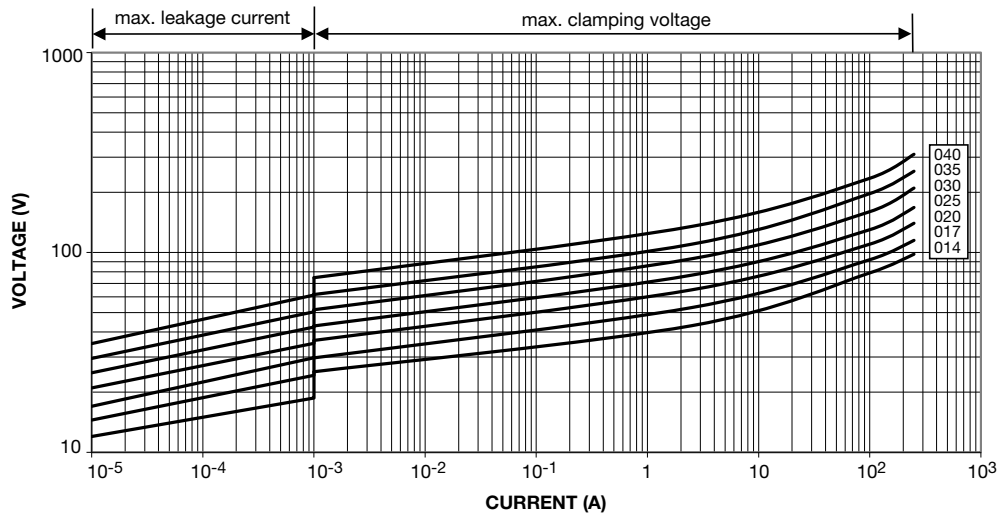

### 50 V<sub>RMS</sub> to 175 V<sub>RMS</sub>; VDRS07

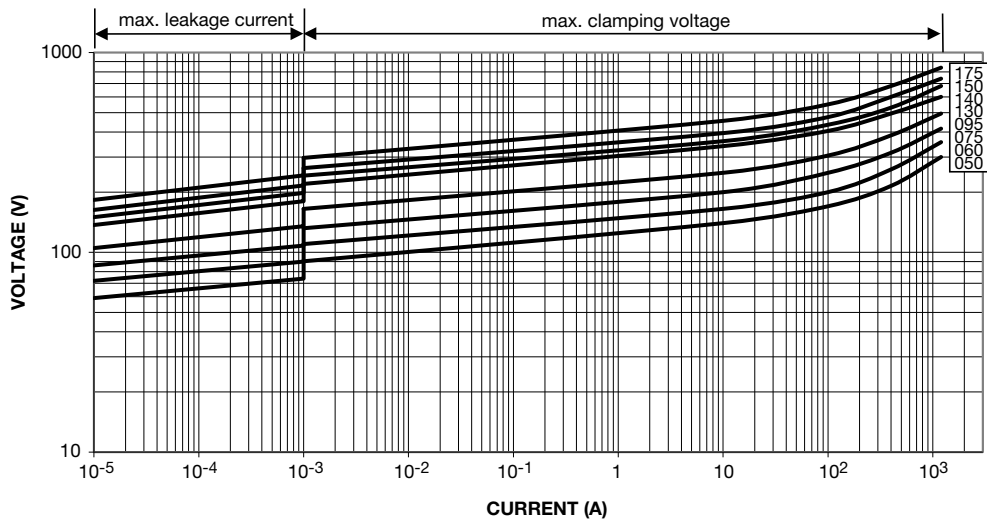

### 230 V<sub>RMS</sub> to 460 V<sub>RMS</sub>; VDRS07

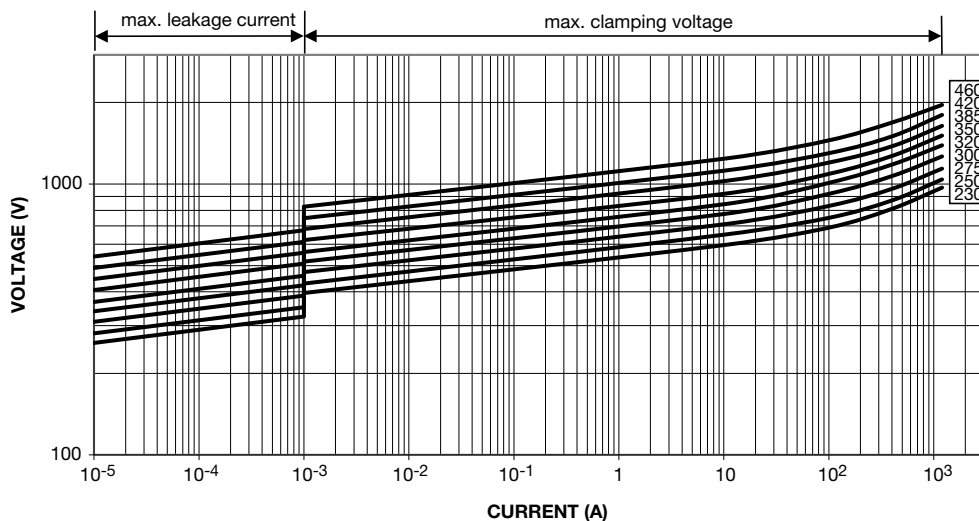



### 14 V<sub>RMS</sub> to 40 V<sub>RMS</sub>; VDRS10

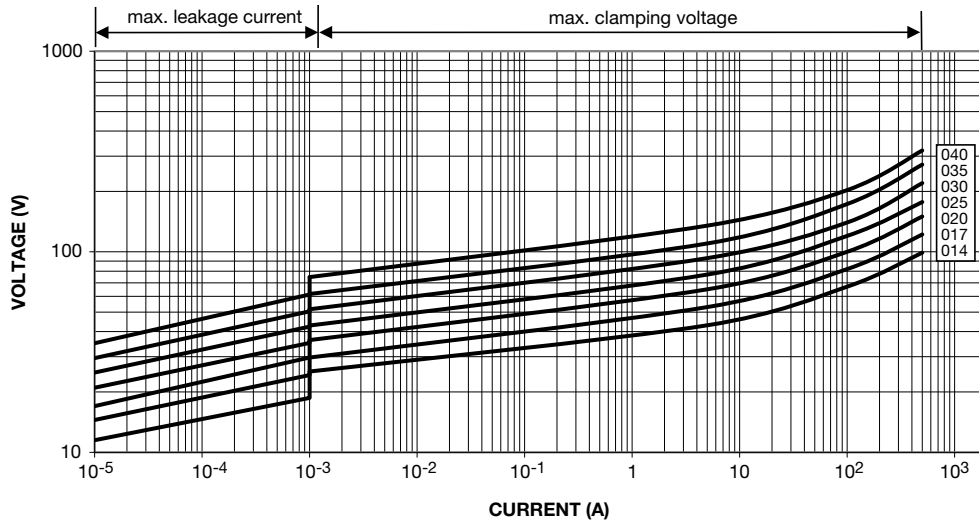

### 50 V<sub>RMS</sub> to 230 V<sub>RMS</sub>; VDRS10

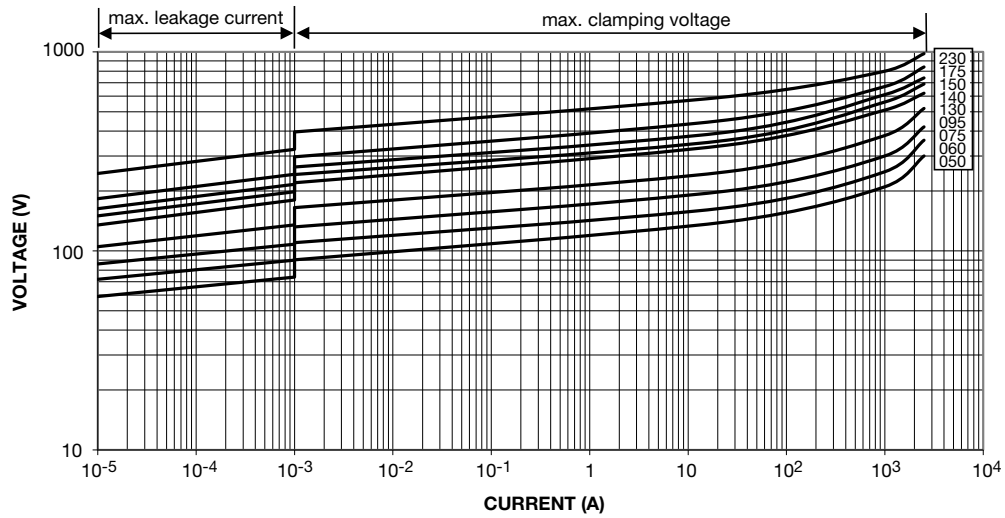

### 250 V<sub>RMS</sub> to 550 V<sub>RMS</sub>; VDRS10

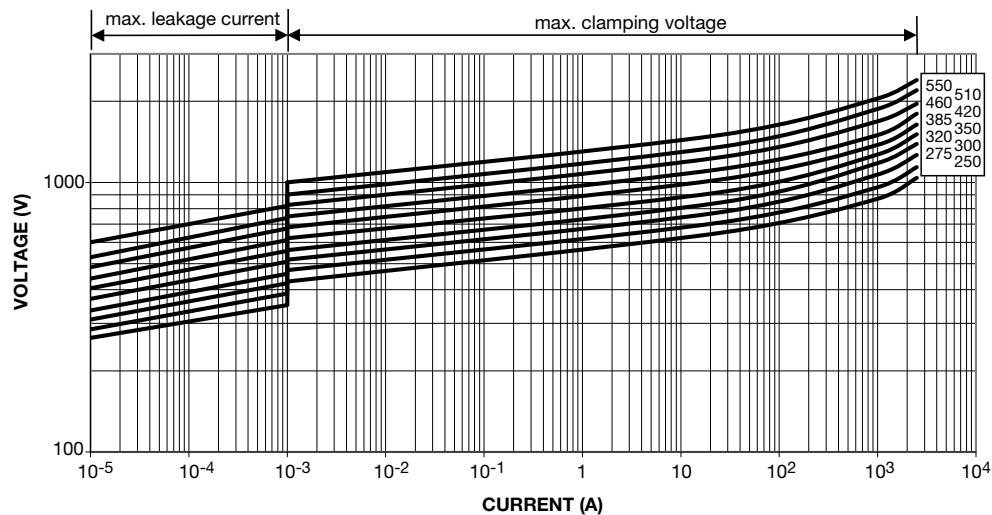



14 V<sub>RMS</sub> to 40 V<sub>RMS</sub>; VDRS14

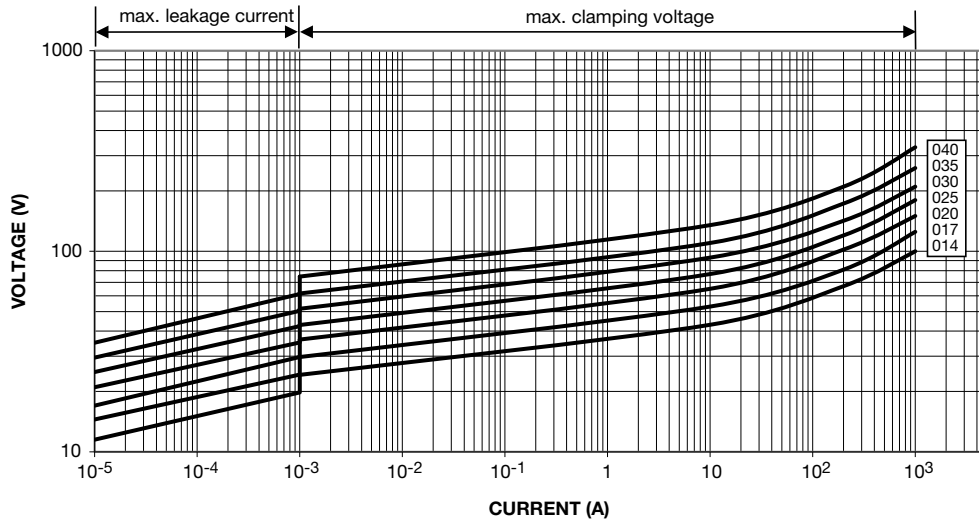

50 V<sub>RMS</sub> to 230 V<sub>RMS</sub>; VDRS14

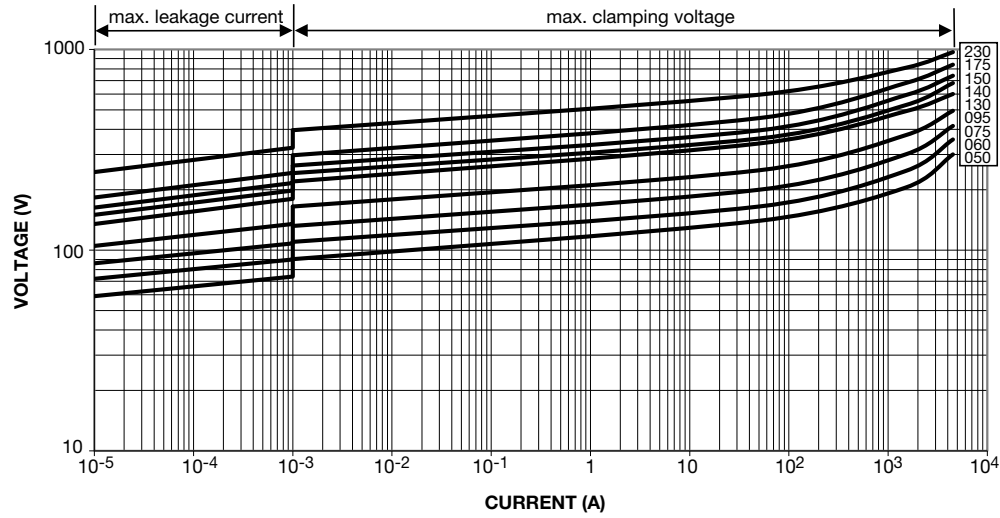

250 V<sub>RMS</sub> to 550 V<sub>RMS</sub>; VDRS14

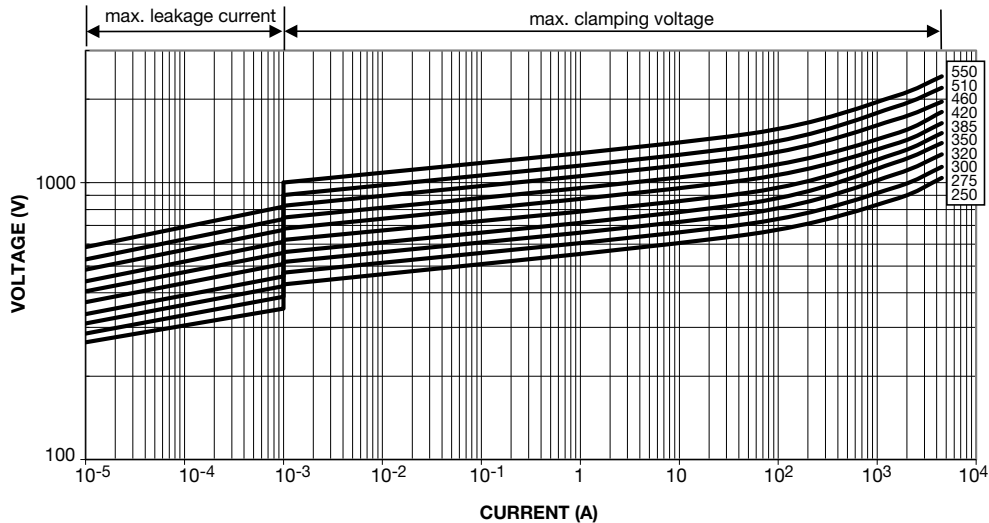



14 V<sub>RMS</sub> to 40 V<sub>RMS</sub>; VDRS20

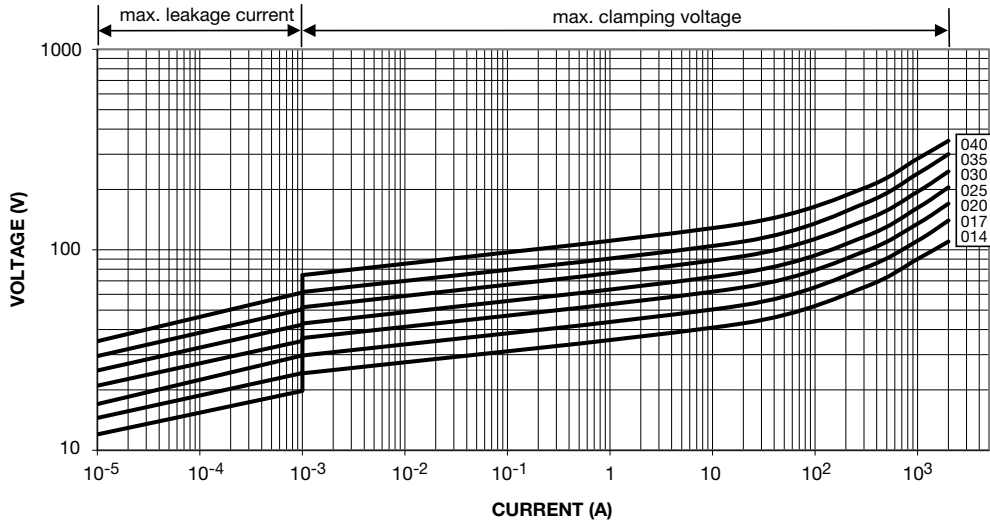

60 V<sub>RMS</sub> to 250 V<sub>RMS</sub>; VDRS20

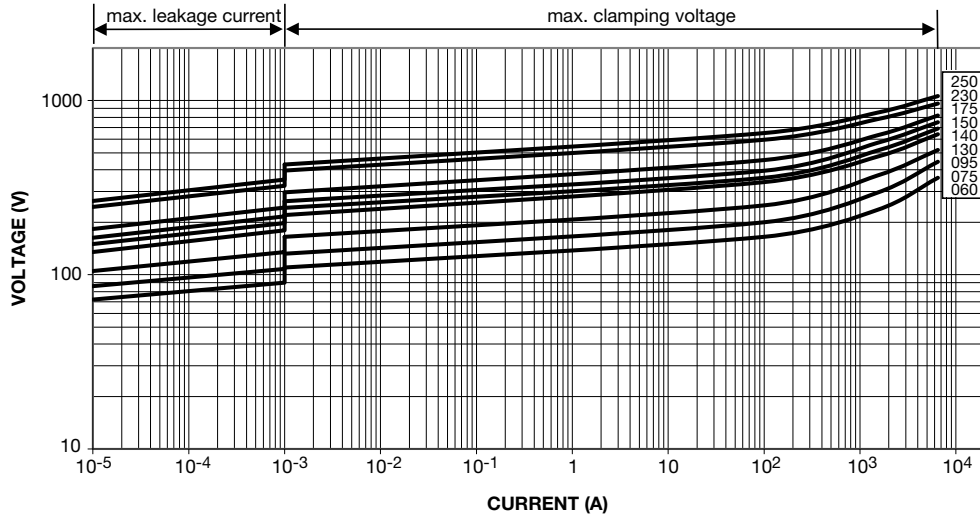

275 V<sub>RMS</sub> to 680 V<sub>RMS</sub>; VDRS20

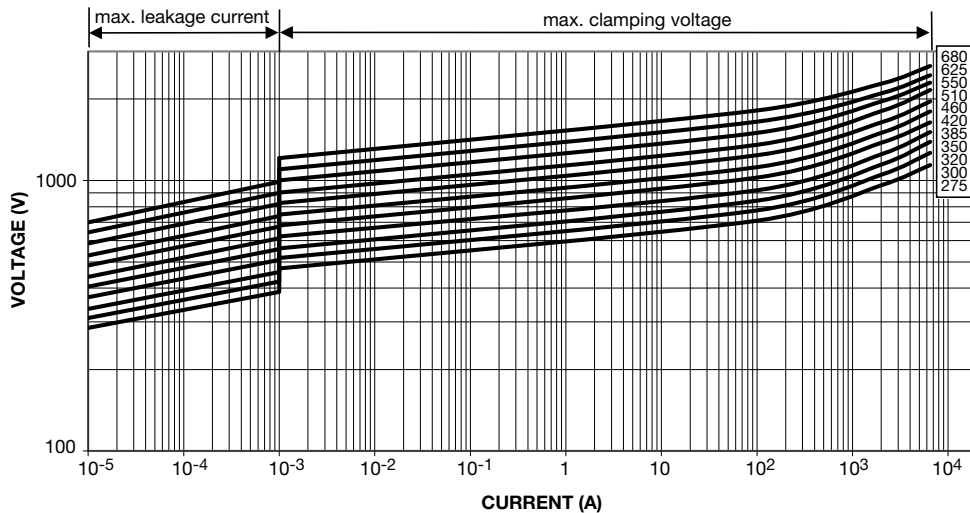



**MAXIMUM APPLICABLE TRANSIENT CURRENT AS A FUNCTION OF PULSE DURATION**

14 V<sub>RMS</sub> to 40 V<sub>RMS</sub>; VDRS05

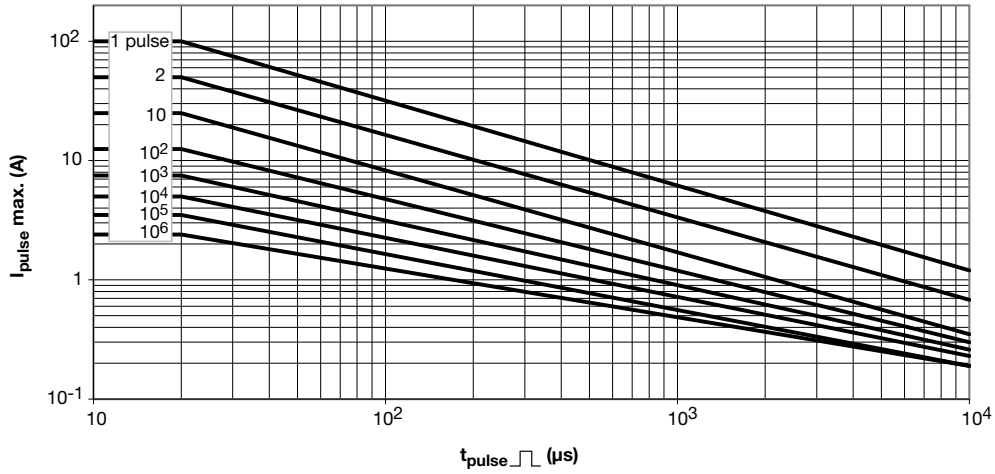

50 V<sub>RMS</sub> to 460 V<sub>RMS</sub>; VDRS05

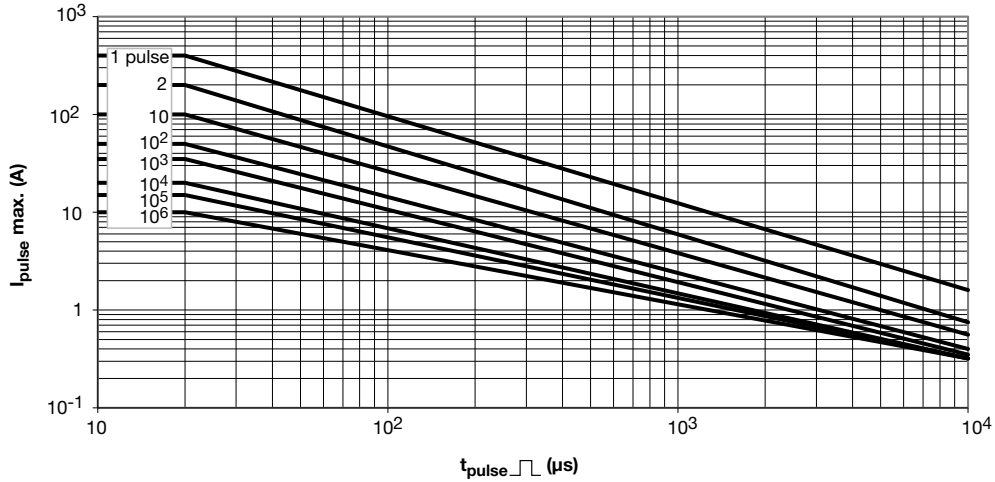

14 V<sub>RMS</sub> to 40 V<sub>RMS</sub>; VDRS07

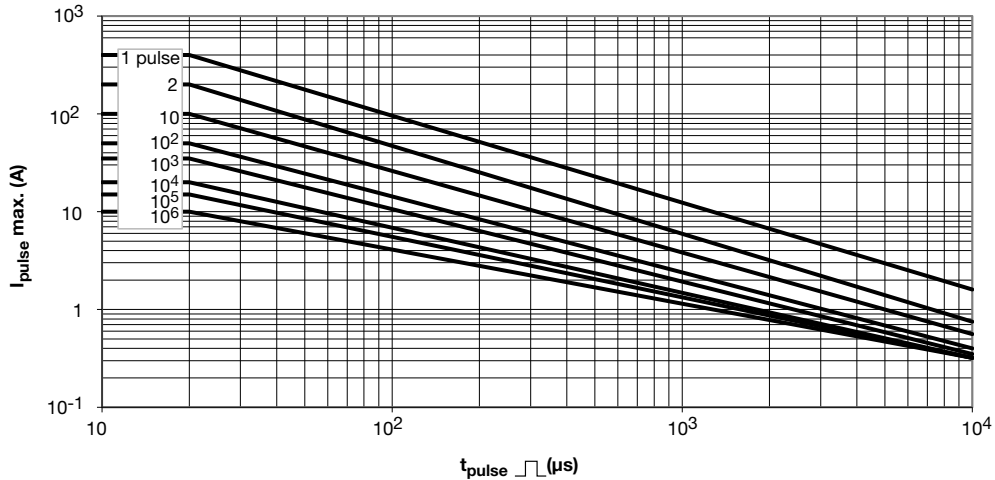





50 V<sub>RMS</sub> to 510 V<sub>RMS</sub>; VDRS07

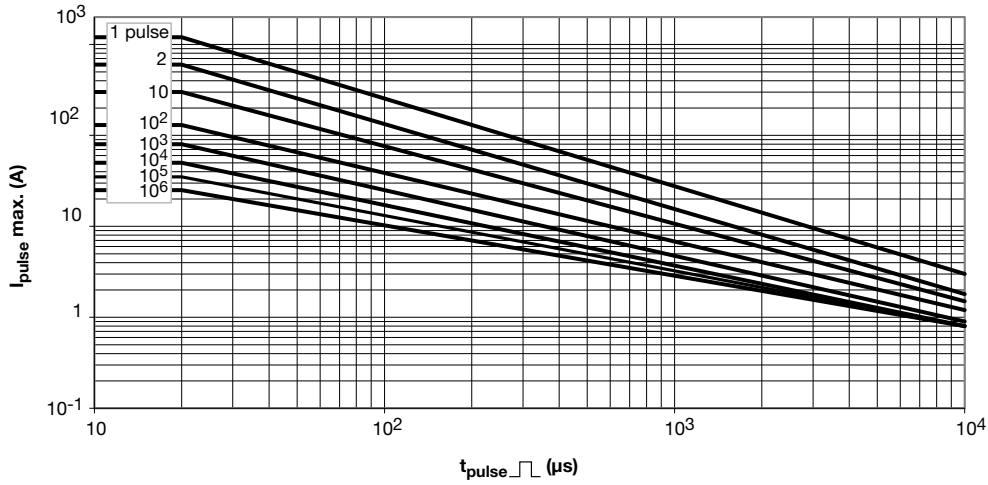

14 V<sub>RMS</sub> to 40 V<sub>RMS</sub>; VDRS10

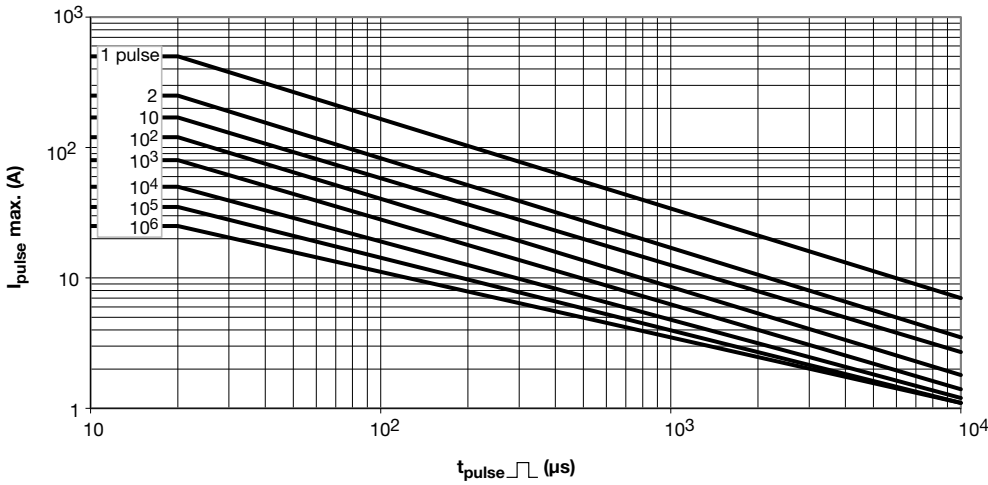

50 V<sub>RMS</sub> to 300 V<sub>RMS</sub>; VDRS10

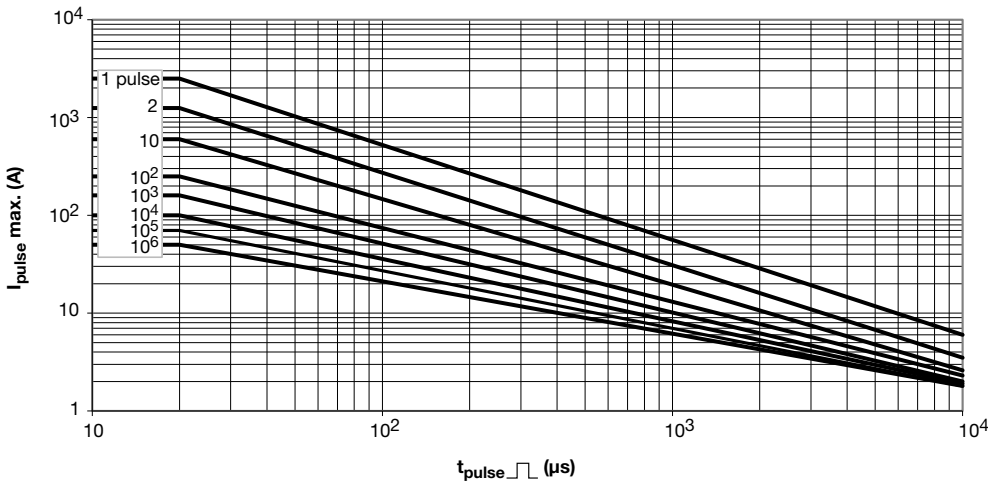



### 320 V<sub>RMS</sub> to 680 V<sub>RMS</sub>; VDRS10

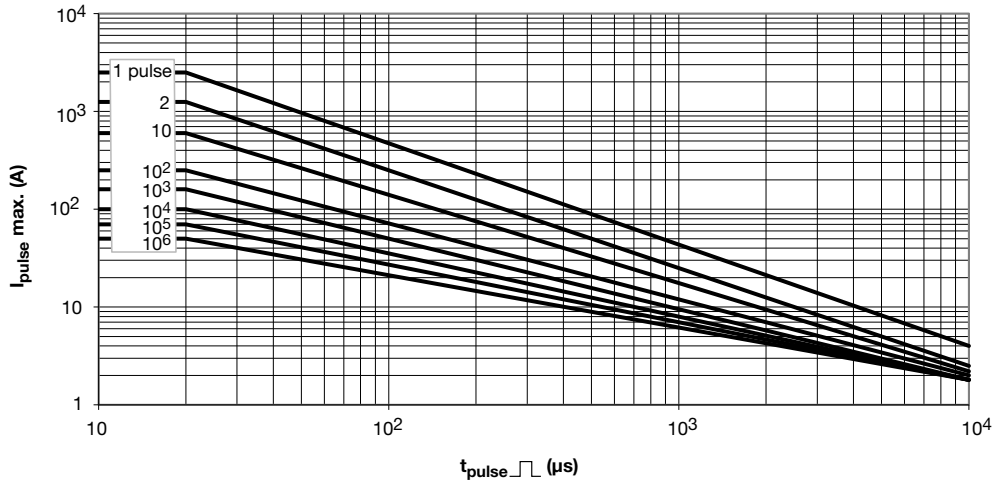

### 14 V<sub>RMS</sub> to 40 V<sub>RMS</sub>; VDRS14

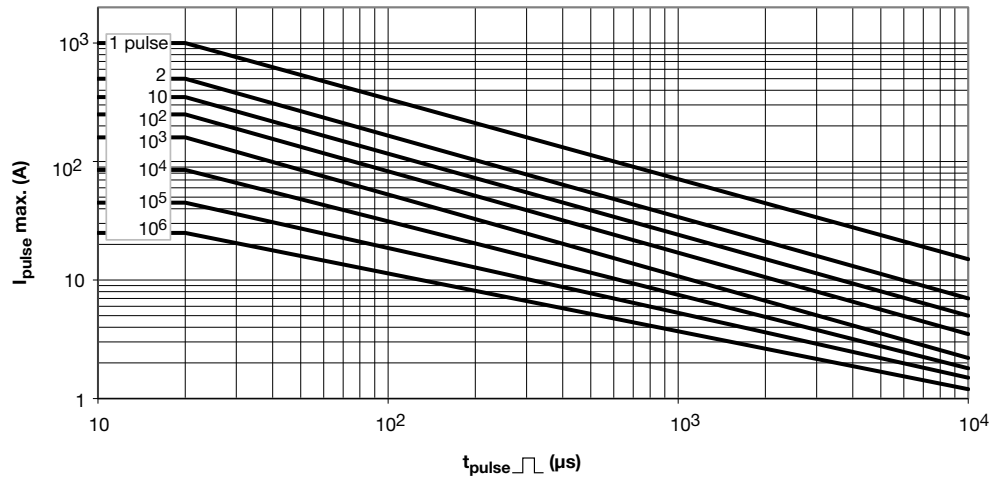

### 50 V<sub>RMS</sub> to 300 V<sub>RMS</sub>; VDRS14

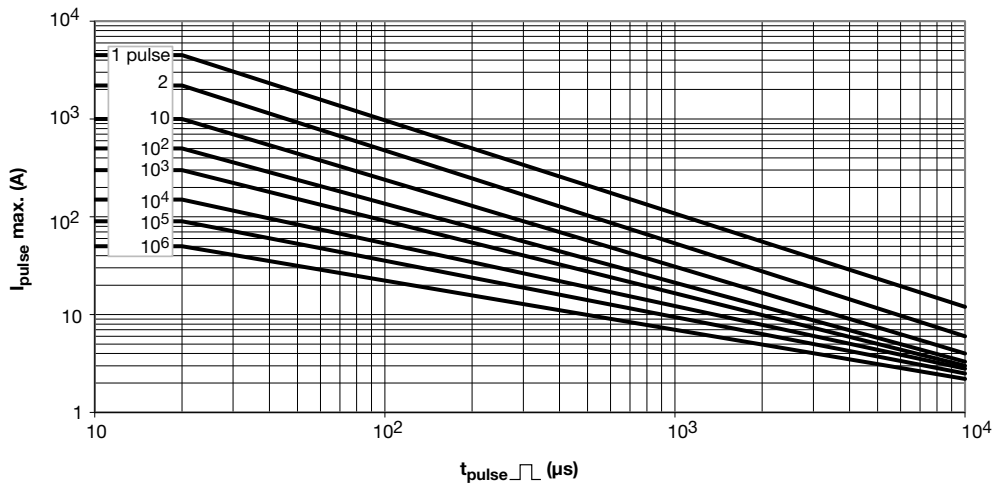



320 V<sub>RMS</sub> to 680 V<sub>RMS</sub>; VDRS14

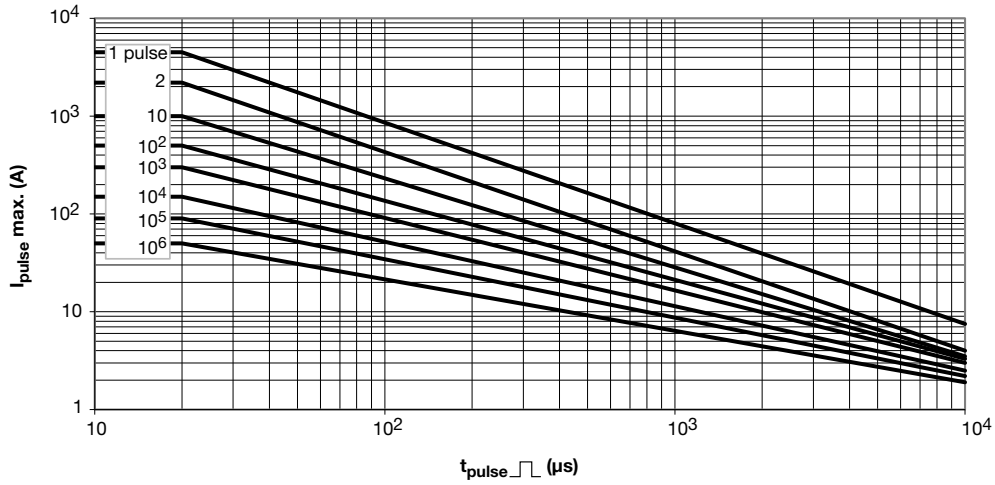

14 V<sub>RMS</sub> to 40 V<sub>RMS</sub>; VDRS20

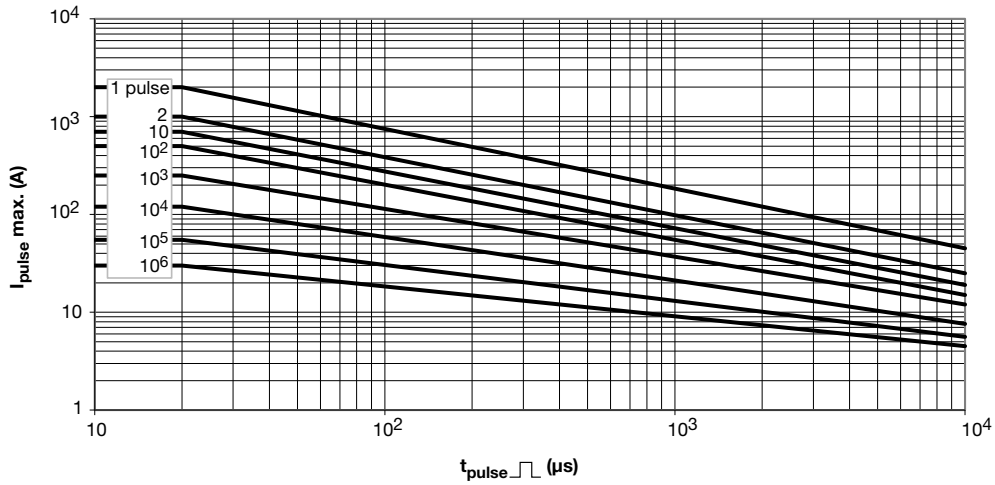

60 V<sub>RMS</sub> to 300 V<sub>RMS</sub>; VDRS20

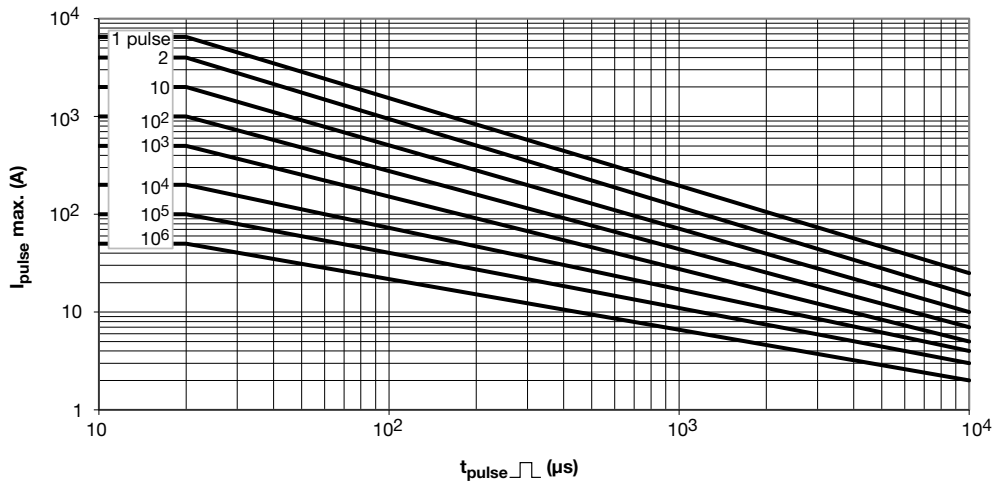



320 V<sub>RMS</sub> to 680 V<sub>RMS</sub>; VDRS20

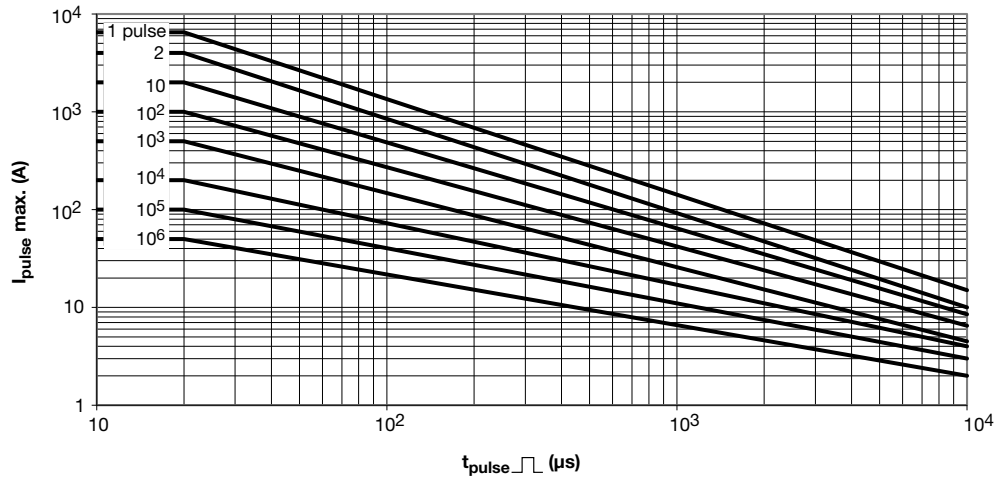



## Disclaimer

ALL PRODUCT, PRODUCT SPECIFICATIONS AND DATA ARE SUBJECT TO CHANGE WITHOUT NOTICE TO IMPROVE RELIABILITY, FUNCTION OR DESIGN OR OTHERWISE.

Vishay Intertechnology, Inc., its affiliates, agents, and employees, and all persons acting on its or their behalf (collectively, "Vishay"), disclaim any and all liability for any errors, inaccuracies or incompleteness contained in any datasheet or in any other disclosure relating to any product.

Vishay makes no warranty, representation or guarantee regarding the suitability of the products for any particular purpose or the continuing production of any product. To the maximum extent permitted by applicable law, Vishay disclaims (i) any and all liability arising out of the application or use of any product, (ii) any and all liability, including without limitation special, consequential or incidental damages, and (iii) any and all implied warranties, including warranties of fitness for particular purpose, non-infringement and merchantability.

Statements regarding the suitability of products for certain types of applications are based on Vishay's knowledge of typical requirements that are often placed on Vishay products in generic applications. Such statements are not binding statements about the suitability of products for a particular application. It is the customer's responsibility to validate that a particular product with the properties described in the product specification is suitable for use in a particular application. Parameters provided in datasheets and / or specifications may vary in different applications and performance may vary over time. All operating parameters, including typical parameters, must be validated for each customer application by the customer's technical experts. Product specifications do not expand or otherwise modify Vishay's terms and conditions of purchase, including but not limited to the warranty expressed therein.

Except as expressly indicated in writing, Vishay products are not designed for use in medical, life-saving, or life-sustaining applications or for any other application in which the failure of the Vishay product could result in personal injury or death. Customers using or selling Vishay products not expressly indicated for use in such applications do so at their own risk. Please contact authorized Vishay personnel to obtain written terms and conditions regarding products designed for such applications.

No license, express or implied, by estoppel or otherwise, to any intellectual property rights is granted by this document or by any conduct of Vishay. Product names and markings noted herein may be trademarks of their respective owners.

单击下面可查看定价，库存，交付和生命周期等信息

[>>Vishay\(威世\)](#)