

KR FAMILY SERIES/KRW•KR•PHN•TR CONNECTOR

Disconnectable Insulation displacement and Crimp style connectors

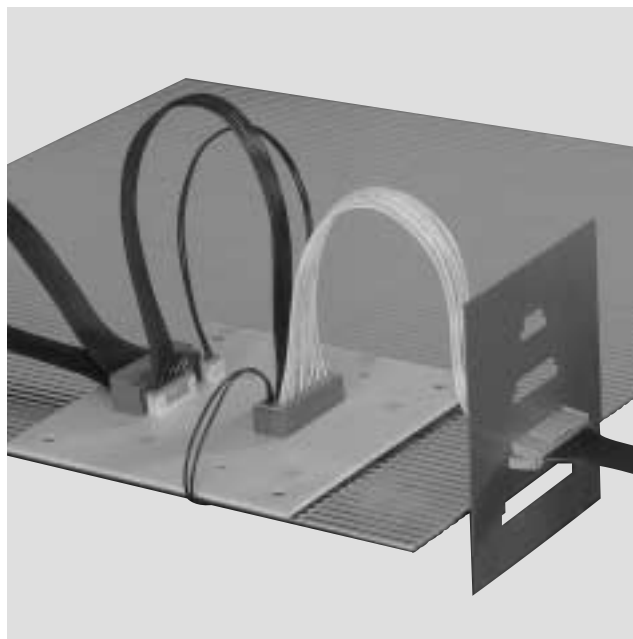

Based upon JST's field proven KR series connectors, the KR series family of connectors have been expanded to meet the requirements of high density packaging. The KRW connector allows double-row wire-to-board connection using either the KR or PHN connectors. Whilst the TR connector allows wire-to-wire connection, also using either the KR or PHN connectors.

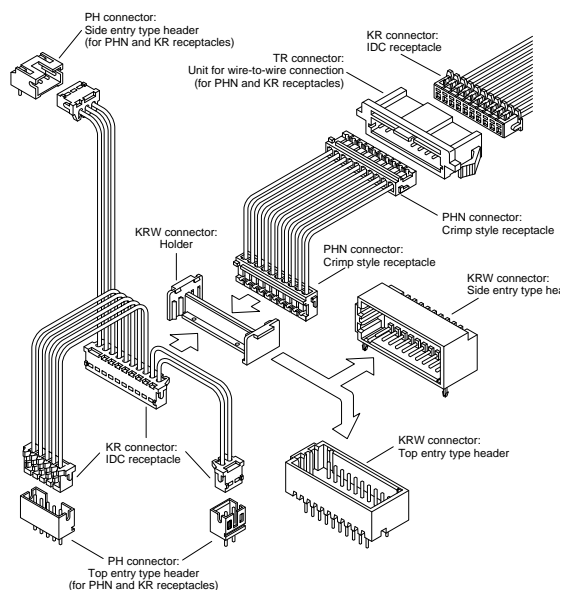

Features

- **Multi-IDC-harnesses are possible**

- **Various types of connectors**

In addition to the KRW, KR, PHN and TR connectors, there are other 2.0mm(.079")pitch connectors available such as the KRD, CR, DA, DD and DS ranges.

- **Cost reduction**

By introducing the KR family series, a reduction in harness production time can be achieved through rationalization/standardization. This in turn, will therefore reduce harness costs, thus benefiting both the harness-maker and the set-maker alike.

- **Two types of circuit layouts**

The connector is available in either the normal or reverse configurations. (Circuit number layouts are different from each other.)

Specifications

Item	Series	KRW connector	TR/TRW connector
Current rating		1.0A AC, DC (AWG#26)	
Voltage rating		100V AC, DC	
Temperature rise		-40°C to +85°C (including temperature rise)	
Contact resistance		Initial value / 10m Ω max. After environmental testing / 20m Ω max.	
Insulation resistance		1,000M Ω min.	
Withstanding voltage		800V AC / minute	
Applicable connector		KR connector, CR connector, PHN connector	
Applicable PC board thickness		1.6mm(.063")	—
Applicable panel thickness		—	0.8 to 2.0mm(.031" to .079")

•Contact JST for details.

Recognized E60389

Certified LR20812

R75087: PH, PHN connectors

R75088: KR connector

R9851222: KRW connector

R9851223: TR connector

KR FAMILY SERIES CONNECTOR

Insulation displacement connector (Receptacle)

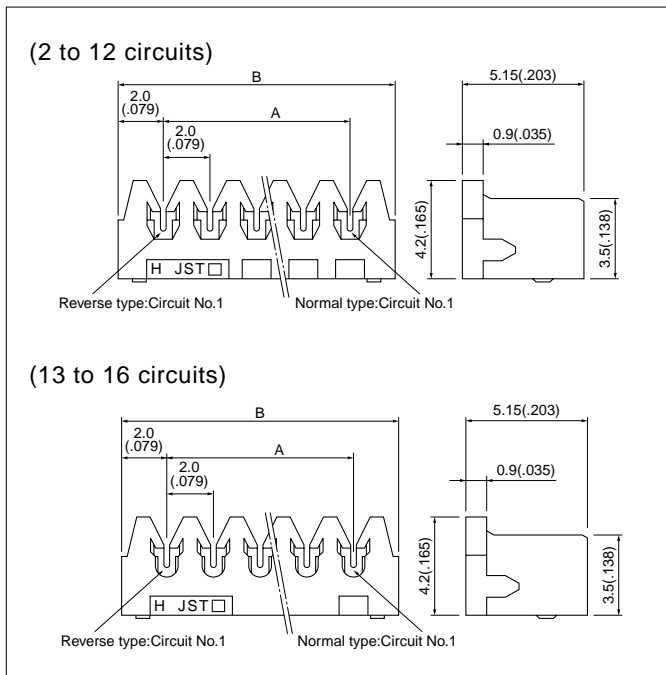

Circuits	Model No.		Dimensions mm(in.)	
	Normal type	Reverse type	A	B
2	02KR-6H-P	02KR-6H-PC	2.0(.079)	6.0(.236)
3	03KR-6H-P	03KR-6H-PC	4.0(.157)	8.0(.315)
4	04KR-6H-P	04KR-6H-PC	6.0(.236)	10.0(.394)
5	05KR-6H-P	05KR-6H-PC	8.0(.315)	12.0(.472)
6	06KR-6H-P	06KR-6H-PC	10.0(.394)	14.0(.551)
7	07KR-6H-P	07KR-6H-PC	12.0(.472)	16.0(.630)
8	08KR-6H-P	08KR-6H-PC	14.0(.551)	18.0(.709)
9	09KR-6H-P	09KR-6H-PC	16.0(.630)	20.0(.787)
10	10KR-6H-P	10KR-6H-PC	18.0(.709)	22.0(.866)
11	11KR-6H-P	11KR-6H-PC	20.0(.787)	24.0(.945)
12	12KR-6H-P	12KR-6H-PC	22.0(.866)	26.0(1.024)
13	13KR-6H-P	13KR-6H-PC	24.0(.945)	28.0(1.102)
14	14KR-6H-P	14KR-6H-PC	26.0(1.024)	30.0(1.181)
15	15KR-6H-P	15KR-6H-PC	28.0(1.102)	32.0(1.260)
16	16KR-6H-P	16KR-6H-PC	30.0(1.181)	34.0(1.339)

Material and Finish

Contact: Phosphor bronze, tin-plated
Housing: 2 to 12 circuits...Nylon 66, UL94V-0, gray
13 to 16 circuits...Glass-filled nylon 66, UL94V-0, gray

Applicable wire

UL1571, 1061(Contact JST for other UL styles.)
AWG#28, #26, #24(Contact JST for AWG#24.)
Conductor / 7 stands, tin-plated annealed copper
Insulation O.D. / 0.9 to 1.0mm(.035" to .039")

Crimp style connector (Contact)

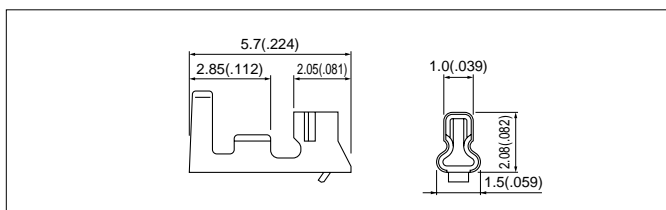

Model No.	Applicable wire		Insulation O.D. mm(in.)	Q'ty/ reel
	mm ²	AWG#		
SPH-002T-P0.5L	0.08 to 0.22	28 to 24	0.8 to 1.5(.013 to .059)	8,000

Material and Finish

Phosphor bronze, tin-plated

Note: SPH-002T-P0.5S is also available.

Applicator for the semi-automatic press AP-K2N

Contact	Crimp applicator MKS-L		Compact crimp applicator MKS-LS		Strip-crimp applicator MKS-SC
	with safety cover	without safety cover	with safety cover	without safety cover	with safety cover
SPH-002T-P0.5L	APLMK SPH002-05L	APLNC SPH002-05L	APLMKLS SPH002-05L	APLLSNC SPH002-05L	-

KR FAMILY SERIES CONNECTOR

Crimp style connector (Housing)

Normal type

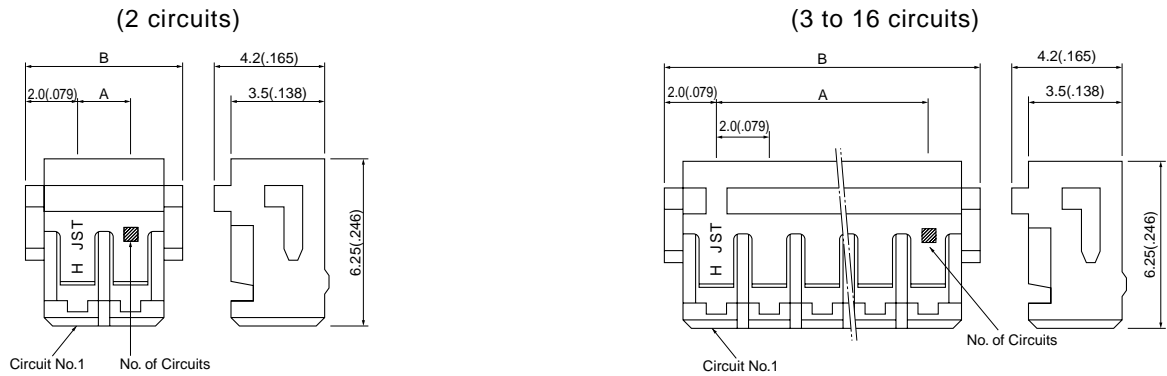

Reverse type

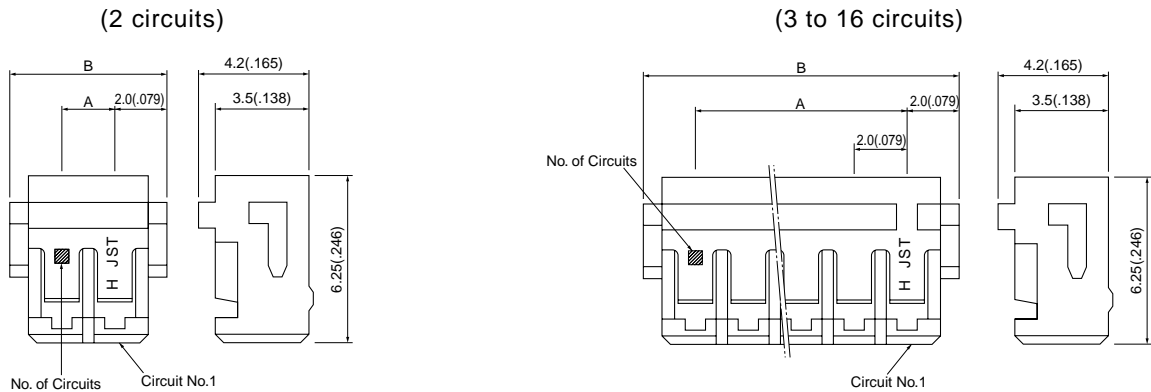

Circuits	Model No.		Dimensions mm(in.)	
	Normal type	Reverse type	A	B
2	PHNR-02-H	PHNR-02C-H	2.0(.079)	6.0(.236)
3	PHNR-03-H	PHNR-03C-H	4.0(.157)	8.0(.315)
4	PHNR-04-H	PHNR-04C-H	6.0(.236)	10.0(.394)
5	PHNR-05-H	PHNR-05C-H	8.0(.315)	12.0(.472)
6	PHNR-06-H	PHNR-06C-H	10.0(.394)	14.0(.551)
7	PHNR-07-H	PHNR-07C-H	12.0(.472)	16.0(.630)
8	PHNR-08-H	PHNR-08C-H	14.0(.551)	18.0(.709)
9	PHNR-09-H	PHNR-09C-H	16.0(.630)	20.0(.787)
10	PHNR-10-H	PHNR-10C-H	18.0(.709)	22.0(.866)
11	PHNR-11-H	PHNR-11C-H	20.0(.787)	24.0(.945)
12	PHNR-12-H	PHNR-12C-H	22.0(.866)	26.0(1.024)
13	PHNR-13-H	PHNR-13C-H	24.0(.945)	28.0(1.102)
14	PHNR-14-H	PHNR-14C-H	26.0(1.024)	30.0(1.181)
15	PHNR-15-H	PHNR-15C-H	28.0(1.102)	32.0(1.260)
16	PHNR-16-H	PHNR-16C-H	30.0(1.181)	34.0(1.339)

Material

Nylon 66, UL94V-0, gray

KR FAMILY SERIES CONNECTOR

Single-row shrouded header (Through-hole type)

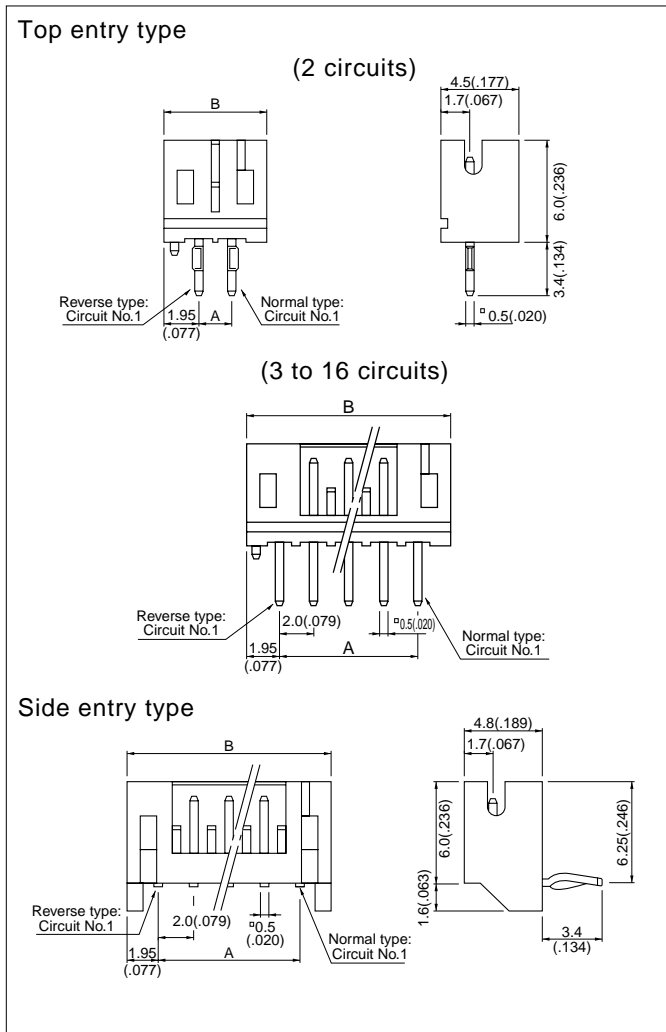

Circuits	Normal type Model No.		Dimensions mm(in.)	
	Top entry type (with a boss)	Side entry type	A	B
2	B 2B-PH-KBL-H	S 2B-PH-KL	2.0(.079)	5.9(.232)
3	B 3B-PH-KBL-H	S 3B-PH-KL	4.0(.157)	7.9(.311)
4	B 4B-PH-KBL-H	S 4B-PH-KL	6.0(.236)	9.9(.390)
5	B 5B-PH-KBL-H	S 5B-PH-KL	8.0(.315)	11.9(.469)
6	B 6B-PH-KBL-H	S 6B-PH-KL	10.0(.394)	13.9(.547)
7	B 7B-PH-KBL-H	S 7B-PH-KL	12.0(.472)	15.9(.626)
8	B 8B-PH-KBL-H	S 8B-PH-KL	14.0(.551)	17.9(.705)
9	B 9B-PH-KBL-H	S 9B-PH-KL	16.0(.630)	19.9(.783)
10	B10B-PH-KBL-H	S10B-PH-KL	18.0(.709)	21.9(.862)
11	B11B-PH-KBL-H	S11B-PH-KL	20.0(.787)	23.9(.941)
12	B12B-PH-KBL-H	S12B-PH-KL	22.0(.866)	25.9(1.020)
13	B13B-PH-KBL-H	S13B-PH-KL	24.0(.945)	27.9(1.098)
14	B14B-PH-KBL-H	S14B-PH-KL	26.0(1.024)	29.9(1.177)
15	B15B-PH-KBL-H	S15B-PH-KL	28.0(1.102)	31.9(1.256)
16	B16B-PH-KBL-H	S16B-PH-KL	30.0(1.181)	33.9(1.335)

Circuits	Reverse type Model No.		Dimensions mm(in.)	
	Top entry type (with a boss)	Side entry type	A	B
2	B 2B-PH-KBLC-H	S 2B-PH-KLC-H	2.0(.079)	5.9(.232)
3	B 3B-PH-KBLC-H	S 3B-PH-KLC-H	4.0(.157)	7.9(.311)
4	B 4B-PH-KBLC-H	S 4B-PH-KLC-H	6.0(.236)	9.9(.390)
5	B 5B-PH-KBLC-H	S 5B-PH-KLC-H	8.0(.315)	11.9(.469)
6	B 6B-PH-KBLC-H	S 6B-PH-KLC-H	10.0(.394)	13.9(.547)
7	B 7B-PH-KBLC-H	S 7B-PH-KLC-H	12.0(.472)	15.9(.626)
8	B 8B-PH-KBLC-H	S 8B-PH-KLC-H	14.0(.551)	17.9(.705)
9	B 9B-PH-KBLC-H	S 9B-PH-KLC-H	16.0(.630)	19.9(.783)
10	B10B-PH-KBLC-H	S10B-PH-KLC-H	18.0(.709)	21.9(.862)
11	B11B-PH-KBLC-H	S11B-PH-KLC-H	20.0(.787)	23.9(.941)
12	B12B-PH-KBLC-H	S12B-PH-KLC-H	22.0(.866)	25.9(1.020)
13	B13B-PH-KBLC-H	S13B-PH-KLC-H	24.0(.945)	27.9(1.098)
14	B14B-PH-KBLC-H	S14B-PH-KLC-H	26.0(1.024)	29.9(1.177)
15	B15B-PH-KBLC-H	S15B-PH-KLC-H	28.0(1.102)	31.9(1.256)
16	B16B-PH-KBLC-H	S16B-PH-KLC-H	30.0(1.181)	33.9(1.335)

Material and Finish

Pin: Copper alloy, copper-undercoated, tin/lead-plated(reflow)
Wafer: Nylon66, UL94V-0, gray

Note: Top entry type headers without boss are also available.
Contact JST for details

PC board layout (viewed from component side)

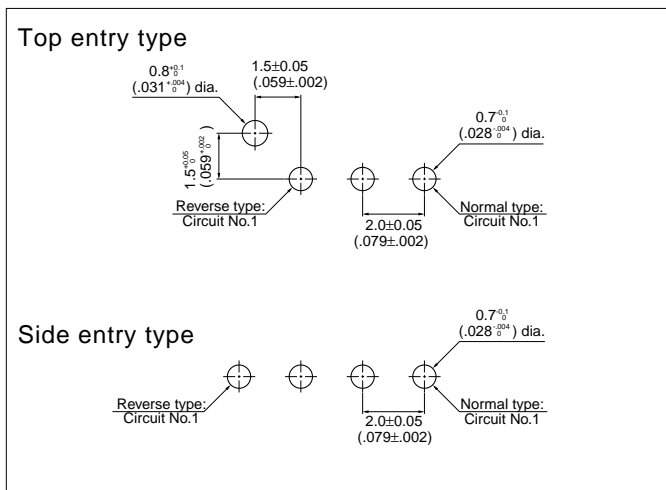

Assembly layout

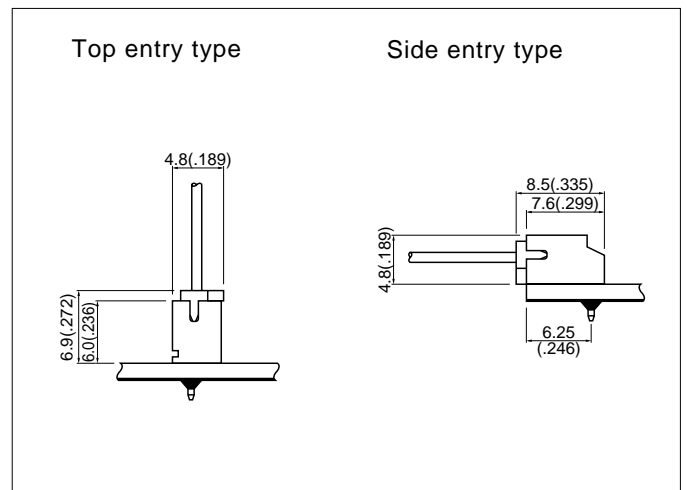

KR FAMILY SERIES CONNECTOR

Single-row shrouded header (SMT type)

Top entry type

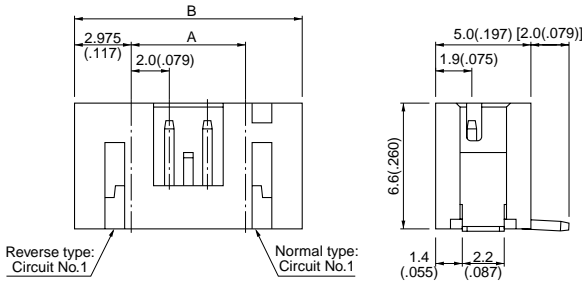

Side entry type

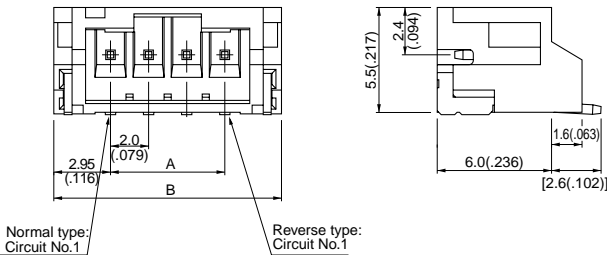

Circuits	Normal type Model No.		Dimensions mm(in.)		Q'ty / reel
	Top entry type (with a boss)	Side entry type	A	B	
2	B 2B-PH-SM3-TB	S 2B-PH-SM3-TB	2.0 (.079)	7.9 (.311)	1,000
3	B 3B-PH-SM3-TB	S 3B-PH-SM3-TB	4.0 (.157)	9.9 (.390)	1,000
4	B 4B-PH-SM3-TB	S 4B-PH-SM3-TB	6.0 (.236)	11.9 (.469)	1,000
5	B 5B-PH-SM3-TB	S 5B-PH-SM3-TB	8.0 (.315)	13.9 (.547)	1,000
6	B 6B-PH-SM3-TB	S 6B-PH-SM3-TB	10.0 (.394)	15.9 (.626)	1,000
7	B 7B-PH-SM3-TB	S 7B-PH-SM3-TB	12.0 (.472)	17.9 (.705)	1,000
8	B 8B-PH-SM3-TB	S 8B-PH-SM3-TB	14.0 (.551)	19.9 (.783)	1,000
9	B 9B-PH-SM3-TB	S 9B-PH-SM3-TB	16.0 (.630)	21.9 (.862)	1,000
10	B10B-PH-SM3-TB	S10B-PH-SM3-TB	18.0 (.709)	23.9 (.941)	1,000
11	B11B-PH-SM3-TB	—	20.0 (.787)	25.9 (1.020)	1,000
12	B12B-PH-SM3-TB	S12B-PH-SM3-TB	22.0 (.866)	27.9 (1.098)	1,000
13	B13B-PH-SM3-TB	S13B-PH-SM3-TB	24.0 (.945)	29.9 (1.177)	1,000
14	B14B-PH-SM3-TB	S14B-PH-SM3-TB	26.0 (1.024)	31.9 (1.256)	1,000
15	B15B-PH-SM3-TB	S15B-PH-SM3-TB	28.0 (1.102)	33.9 (1.335)	1,000
16	B16B-PH-SM3-TB	—	30.0 (1.181)	35.9 (1.413)	1,000

Note: 1. The products listed above are supplied on embossed tape.
2. Contact JST for the top entry type headers with suction cap.

Circuits	Reverse type Model No.		Dimensions mm(in.)		Q'ty / reel
	Top entry type (with a boss)	Side entry type	A	B	
2	B 2B-PH-SM3C-TB	S 2B-PH-SM3C-TB	2.0 (.079)	7.9 (.311)	1,000
3	B 3B-PH-SM3C-TB	S 3B-PH-SM3C-TB	4.0 (.157)	9.9 (.390)	1,000
4	B 4B-PH-SM3C-TB	S 4B-PH-SM3C-TB	6.0 (.236)	11.9 (.469)	1,000
5	B 5B-PH-SM3C-TB	S 5B-PH-SM3C-TB	8.0 (.315)	13.9 (.547)	1,000
6	B 6B-PH-SM3C-TB	S 6B-PH-SM3C-TB	10.0 (.394)	15.9 (.626)	1,000
7	B 7B-PH-SM3C-TB	S 7B-PH-SM3C-TB	12.0 (.472)	17.9 (.705)	1,000
8	B 8B-PH-SM3C-TB	S 8B-PH-SM3C-TB	14.0 (.551)	19.9 (.783)	1,000
9	B 9B-PH-SM3C-TB	S 9B-PH-SM3C-TB	16.0 (.630)	21.9 (.862)	1,000
10	B10B-PH-SM3C-TB	S10B-PH-SM3C-TB	18.0 (.709)	23.9 (.941)	1,000
11	B11B-PH-SM3C-TB	—	20.0 (.787)	25.9 (1.020)	1,000
12	B12B-PH-SM3C-TB	S12B-PH-SM3C-TB	22.0 (.866)	27.9 (1.098)	1,000
13	B13B-PH-SM3C-TB	S13B-PH-SM3C-TB	24.0 (.945)	29.9 (1.177)	1,000
14	B14B-PH-SM3C-TB	S14B-PH-SM3C-TB	26.0 (1.024)	31.9 (1.256)	1,000
15	B15B-PH-SM3C-TB	S15B-PH-SM3C-TB	28.0 (1.102)	33.9 (1.335)	1,000
16	B16B-PH-SM3C-TB	—	30.0 (1.181)	35.9 (1.413)	1,000

Material and Finish

Pin: Copper alloy, copper-undercoated, tin/lead-plated
Housing: Nylon 66, UL94V-0, ivory (natural)
Solder tab: Brass, copper-undercoated, tin/lead-plated

Note: The products listed above are supplied on embossed tape.

PC board layout (viewed from component side)

Top entry type

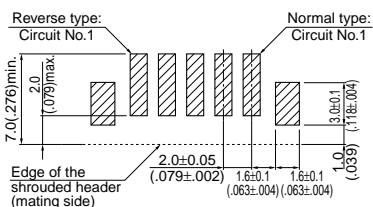

Side entry type

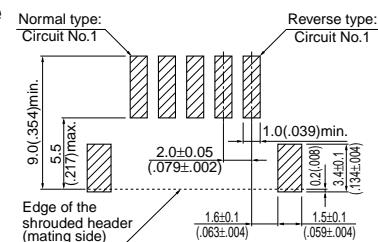

Assembly layout

Top entry type

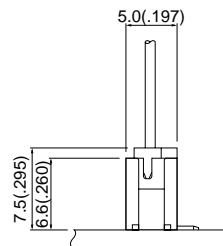

Side entry type

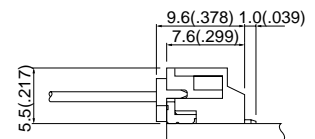

KR FAMILY SERIES CONNECTOR

Double-row shrouded Header

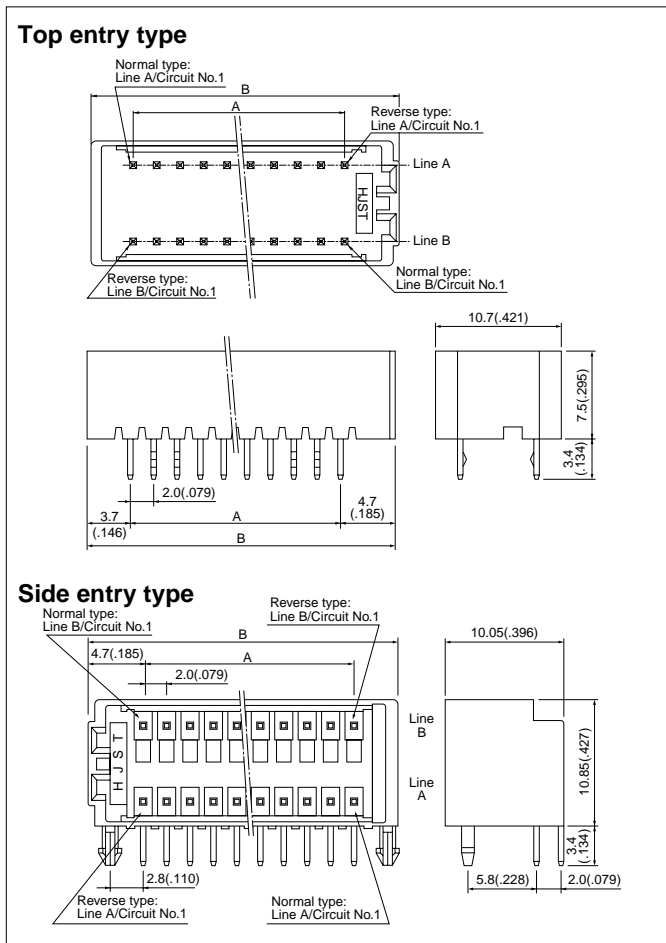

Circuits	Model No.				Dimensions mm(in.)	
	Normal type		Reverse type		A	B
	Top entry type	Side entry type	Top entry type	Side entry type		
10	B10B-KRWHK	—	B10B-KRWHK-C	—	8.0(.315)	16.4(.646)
12	B12B-KRWHK	—	B12B-KRWHK-C	—	10.0(.394)	18.4(.724)
14	B14B-KRWHK	—	B14B-KRWHK-C	—	12.0(.472)	20.4(.803)
16	B16B-KRWHK	S16B-KRWHS	B16B-KRWHK-C	S16B-KRWHS-C	14.0(.551)	22.4(.882)
18	B18B-KRWHK	S18B-KRWHS	B18B-KRWHK-C	S18B-KRWHS-C	16.0(.630)	24.4(.961)
20	B20B-KRWHK	S20B-KRWHS	B20B-KRWHK-C	S20B-KRWHS-C	18.0(.709)	26.4(1.039)
22	B22B-KRWHK	S22B-KRWHS	B22B-KRWHK-C	S22B-KRWHS-C	20.0(.787)	28.4(1.118)
24	B24B-KRWHK	S24B-KRWHS	B24B-KRWHK-C	S24B-KRWHS-C	22.0(.866)	30.4(1.197)
26	B26B-KRWHK	S26B-KRWHS	B26B-KRWHK-C	S26B-KRWHS-C	24.0(.945)	32.4(1.276)
28	B28B-KRWHK	S28B-KRWHS	B28B-KRWHK-C	S28B-KRWHS-C	26.0(1.024)	34.4(1.354)
30	B30B-KRWHK	S30B-KRWHS	B30B-KRWHK-C	S30B-KRWHS-C	28.0(1.102)	36.4(1.433)
32	B32B-KRWHK	S32B-KRWHS	B32B-KRWHK-C	S32B-KRWHS-C	30.0(1.181)	38.4(1.512)

Material and Finish

Post: Copper alloy, copper-undercoated, tin/lead-plated
Wafer: Nylon 66, UL94V-0, gray

Note:

1. Top entry type headers with bosses or without kinked tails are also available.
2. The products listed above are supplied packed in tray.

Double-row shrouded Header (with locks)

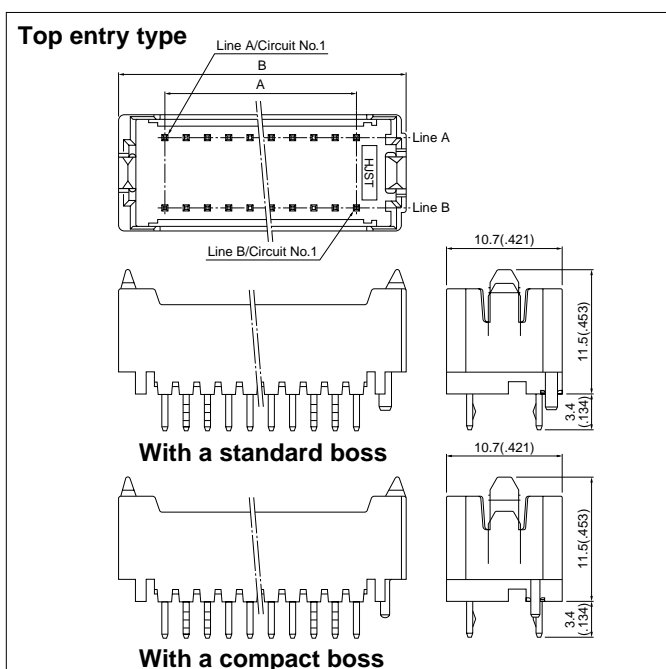

Circuits	Model No.			Dimensions mm(in.)	
	Top entry type			A	B
	Without bosses	With a standard boss	With a compact boss		
10	B10B-KRWHK-F	B10B-KRWHK-F-1	B10B-KRWHK-F-1D	8.0(.315)	17.0(.669)
12	B12B-KRWHK-F	B12B-KRWHK-F-1	B12B-KRWHK-F-1D	10.0(.394)	19.0(.748)
14	B14B-KRWHK-F	B14B-KRWHK-F-1	B14B-KRWHK-F-1D	12.0(.472)	21.0(.827)
16	B16B-KRWHK-F	B16B-KRWHK-F-1	B16B-KRWHK-F-1D	14.0(.551)	23.0(.906)
18	B18B-KRWHK-F	B18B-KRWHK-F-1	B18B-KRWHK-F-1D	16.0(.630)	25.0(.984)
20	B20B-KRWHK-F	B20B-KRWHK-F-1	B20B-KRWHK-F-1D	18.0(.709)	27.0(1.063)
22	B22B-KRWHK-F	B22B-KRWHK-F-1	B22B-KRWHK-F-1D	20.0(.787)	29.0(1.142)
24	B24B-KRWHK-F	B24B-KRWHK-F-1	B24B-KRWHK-F-1D	22.0(.866)	31.0(1.220)
26	B26B-KRWHK-F	B26B-KRWHK-F-1	B26B-KRWHK-F-1D	24.0(.945)	33.0(1.299)
28	B28B-KRWHK-F	B28B-KRWHK-F-1	B28B-KRWHK-F-1D	26.0(1.024)	35.0(1.378)
30	B30B-KRWHK-F	B30B-KRWHK-F-1	B30B-KRWHK-F-1D	28.0(1.102)	37.0(1.457)
32	B32B-KRWHK-F	B32B-KRWHK-F-1	B32B-KRWHK-F-1D	30.0(1.181)	39.0(1.535)

Material and Finish

Post: Copper alloy, copper-undercoated, tin/lead-plated
Wafer: Nylon 66, UL94V-0, gray

Note: The products listed above are supplied packed in tray.

KR FAMILY SERIES CONNECTOR

PC board layout (viewed from component side)

Assembly layout

Top entry type

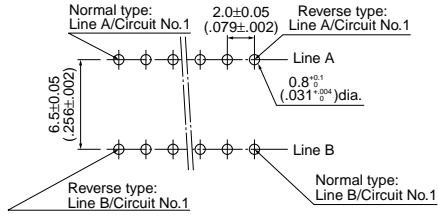

With locks

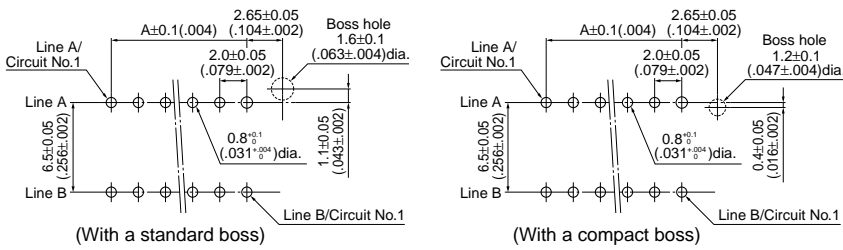

Side entry type

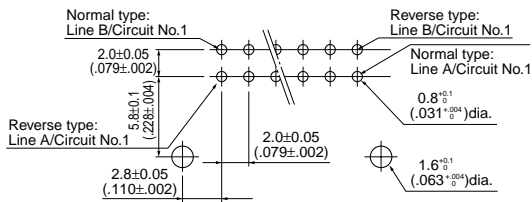

Top entry type

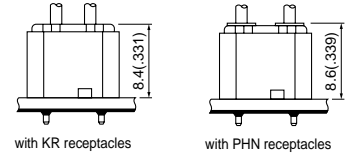

With locks

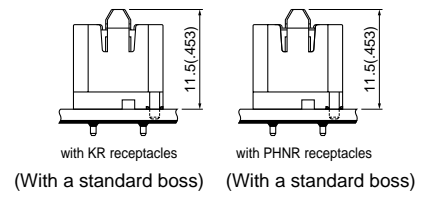

Side entry type

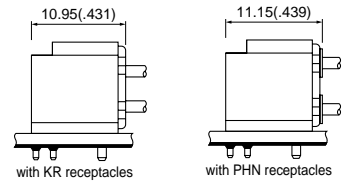

KR FAMILY SERIES CONNECTOR

KRW connector Holder

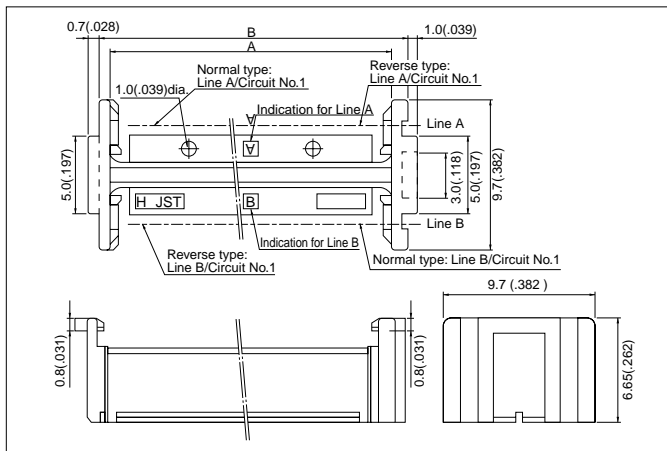

Circuits	Model No.		Dimensions mm(in.)	
	Normal type	Reverse type	A	B
10	KRWH-10-H	KRWH-10C-H	12.0(.472)	14.4(.567)
12	KRWH-12-H	KRWH-12C-H	14.0(.551)	16.4(.646)
14	KRWH-14-H	KRWH-14C-H	16.0(.630)	18.4(.724)
16	KRWH-16-H	KRWH-16C-H	18.0(.709)	20.4(.803)
18	KRWH-18-H	KRWH-18C-H	20.0(.787)	22.4(.882)
20	KRWH-20-H	KRWH-20C-H	22.0(.866)	24.4(.961)
22	KRWH-22-H	KRWH-22C-H	24.0(.945)	26.4(1.039)
24	KRWH-24-H	KRWH-24C-H	26.0(1.024)	28.4(1.118)
26	KRWH-26-H	KRWH-26C-H	28.0(1.102)	30.4(1.197)
28	KRWH-28-H	KRWH-28C-H	30.0(1.181)	32.4(1.276)
30	KRWH-30-H	KRWH-30C-H	32.0(1.260)	34.4(1.354)
32	KRWH-32-H	KRWH-32C-H	34.0(1.339)	36.4(1.433)

Material

Nylon 66, UL94V-0, gray

TR connector (Unit for wire-to-wire connection)

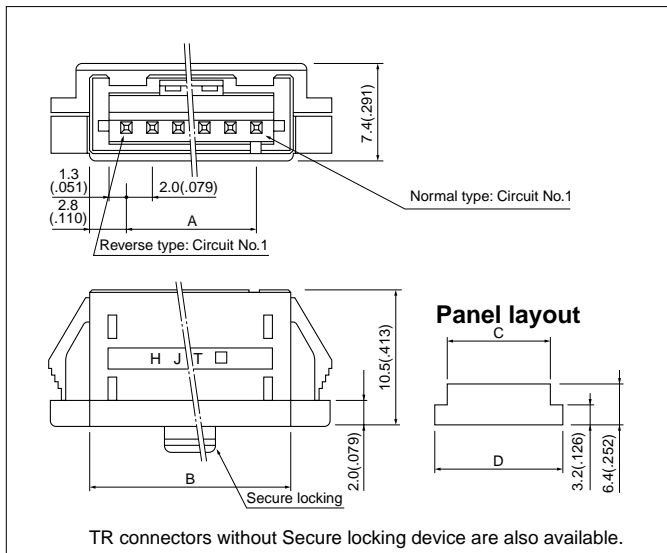

Circuits	Model No.		Dimensions mm(in.)			
	Normal type	Reverse type	A	B	C	D
2	BU02P-TR-P-H	BU02P-TR-PC-H	2.0(.079)	7.6(.299)	7.9(.311)	11.6(.457)
3	BU03P-TR-P-H	BU03P-TR-PC-H	4.0(.157)	9.6(.378)	9.9(.390)	13.6(.535)
4	BU04P-TR-P-H	BU04P-TR-PC-H	6.0(.236)	11.6(.457)	11.9(.469)	15.6(.614)
5	BU05P-TR-P-H	BU05P-TR-PC-H	8.0(.315)	13.6(.535)	13.9(.547)	17.6(.693)
6	BU06P-TR-P-H	BU06P-TR-PC-H	10.0(.394)	15.6(.614)	15.9(.626)	19.6(.772)
7	BU07P-TR-P-H	BU07P-TR-PC-H	12.0(.472)	17.6(.693)	18.0(.709)	21.6(.850)
8	BU08P-TR-P-H	BU08P-TR-PC-H	14.0(.551)	19.6(.772)	20.0(.787)	23.6(.929)
9	BU09P-TR-P-H	BU09P-TR-PC-H	16.0(.630)	21.6(.850)	22.0(.866)	25.6(1.008)
10	BU10P-TR-P-H	BU10P-TR-PC-H	18.0(.709)	23.6(.929)	24.0(.945)	27.6(1.087)
11	BU11P-TR-P-H	BU11P-TR-PC-H	20.0(.787)	25.6(1.008)	26.0(1.024)	29.6(1.165)
12	BU12P-TR-P-H	BU12P-TR-PC-H	22.0(.866)	27.6(1.087)	28.0(1.102)	31.6(1.244)
13	BU13P-TR-P-H	BU13P-TR-PC-H	24.0(.945)	29.6(1.165)	30.0(1.181)	33.6(1.323)
14	BU14P-TR-P-H	BU14P-TR-PC-H	26.0(1.024)	31.6(1.244)	32.0(1.260)	35.6(1.402)
15	BU15P-TR-P-H	BU15P-TR-PC-H	28.0(1.102)	33.6(1.323)	34.0(1.339)	37.6(1.480)
16	BU16P-TR-P-H	BU16P-TR-PC-H	30.0(1.181)	35.6(1.402)	36.0(1.417)	39.6(1.559)

Material and Finish

Post: Copper alloy, copper-undercoated, tin/lead-plated
Housing: Nylon 66, UL94V-0, gray

TRW connector (Unit for wire-to-wire connection)

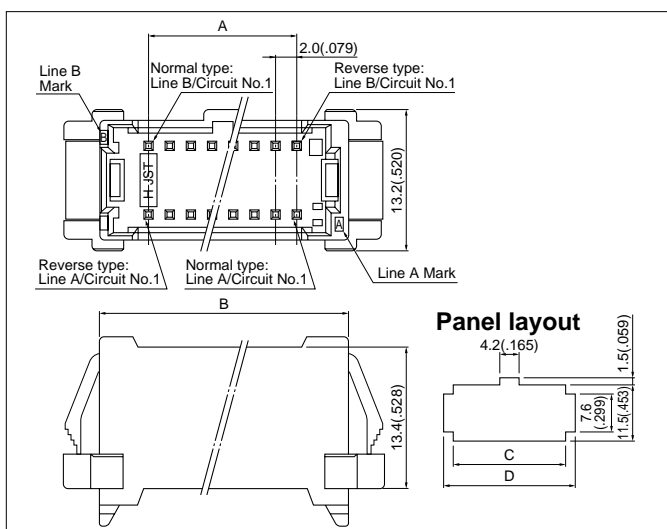

Circuits	Model No.		Dimensions mm(in.)			
	Normal type	Reverse type	A	B	C	D
16	BU16P-TRW-P-H	BU16P-TRW-PC-H	14.0(.551)	23.5(.925)	23.9(.941)	27.5(1.083)
18	BU18P-TRW-P-H	BU18P-TRW-PC-H	16.0(.630)	25.5(1.004)	25.9(1.020)	29.5(1.161)
20	BU20P-TRW-P-H	BU20P-TRW-PC-H	18.0(.709)	27.5(1.083)	27.9(1.098)	31.5(1.240)
22	BU22P-TRW-P-H	BU22P-TRW-PC-H	20.0(.787)	29.5(1.161)	29.9(1.177)	33.5(1.319)
24	BU24P-TRW-P-H	BU24P-TRW-PC-H	22.0(.866)	31.5(1.240)	31.9(1.256)	35.5(1.398)
26	BU26P-TRW-P-H	BU26P-TRW-PC-H	24.0(.945)	33.5(1.319)	33.9(1.335)	37.5(1.476)
28	BU28P-TRW-P-H	BU28P-TRW-PC-H	26.0(1.024)	35.5(1.398)	35.9(1.413)	39.5(1.555)
30	BU30P-TRW-P-H	BU30P-TRW-PC-H	28.0(1.102)	37.5(1.476)	37.9(1.492)	41.5(1.634)
32	BU32P-TRW-P-H	BU32P-TRW-PC-H	30.0(1.181)	39.5(1.555)	39.9(1.571)	43.5(1.713)

Material and Finish

Post: Copper alloy, copper-undercoated, tin/lead-plated
Housing: Nylon 66, UL94V-0

单击下面可查看定价，库存，交付和生命周期等信息

[>>JST\(日本压着端子製造株式会社\)](#)