



SOD-323 Plastic-Encapsulate Diodes

B5817WS-5819WS SCHOTTKY BARRIER DIODE

FEATURES

For use in low voltage, high frequency inverters
Free wheeling, and polarity protection applications

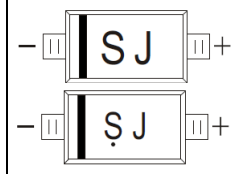
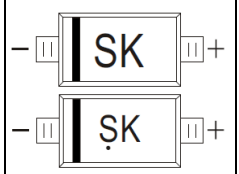
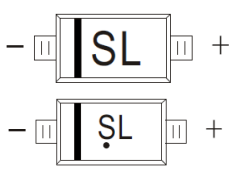
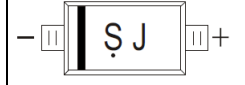
MARKING:

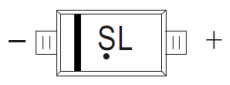
| B5817WS:SJ | B5818WS:SK | B5819WS:SL |
|---|---|---|
|  |  |  |
|  |  |  |

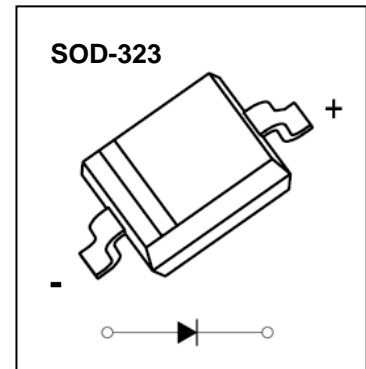

The marking bar indicates the cathode
Solid dot = Green molding compound device, if none, the normal device.

Maximum Ratings and Electrical Characteristics, Single Diode @Ta=25°C

| Parameter | Symbol | B5817WS | B5818WS | B5819WS | Unit |
|--|-----------------|----------|---------|---------|------|
| Non-repetitive peak reverse voltage | V_{RM} | 20 | 30 | 40 | V |
| Peak repetitive peak reverse voltage | V_{RRM} | 20 | 30 | 40 | V |
| Working peak reverse voltage | V_{RWM} | | | | |
| DC blocking voltage | V_R | | | | |
| RMS reverse voltage | $V_{R(RMS)}$ | 14 | 21 | 28 | V |
| Average rectified output current | I_O | 1 | | | A |
| Forward surge current | I_{FSM} | 9 | | | A |
| Repetitive peak forward current | I_{FRM} | 1.5 | | | A |
| Power dissipation | P_d | 250 | | | mW |
| Thermal resistance junction to ambient | $R_{\theta JA}$ | 400 | | | °C/W |
| Operation Junction temperature Range | T_J | -40~+125 | | | °C |
| Storage temperature Range | T_{STG} | -55~+150 | | | °C |

ELECTRICAL CHARACTERISTICS (Ta=25°C unless otherwise specified)

| Parameter | Symbol | Test conditions | Min | Max | Unit |
|---------------------------------|------------|--------------------|----------|-------|------|
| Reverse breakdown voltage | $V_{(BR)}$ | $I_R=1mA$ | | | V |
| | | B5817WS | 20 | | |
| | | B5818WS B5819WS | 30 40 | | |
| Reverse voltage leakage current | I_R | $V_R=20V$ | | 1 | mA |
| | | $V_R=30V$ | | | |
| | | $V_R=40V$ | | | |
| Forward voltage | V_F | B5817WS | $I_F=1A$ | 0.45 | V |
| | | | $I_F=3A$ | 0.75 | |
| | | B5818WS | $I_F=1A$ | 0.55 | V |
| | | | $I_F=3A$ | 0.875 | |
| | | B5819WS | $I_F=1A$ | 0.6 | V |
| | | | $I_F=3A$ | 0.9 | |
| Diode capacitance | C_D | $V_R=4V, f=1MHz$ | | 120 | pF |

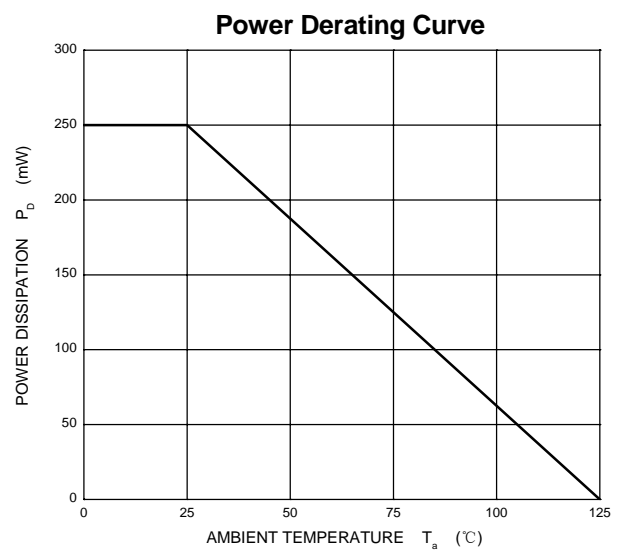
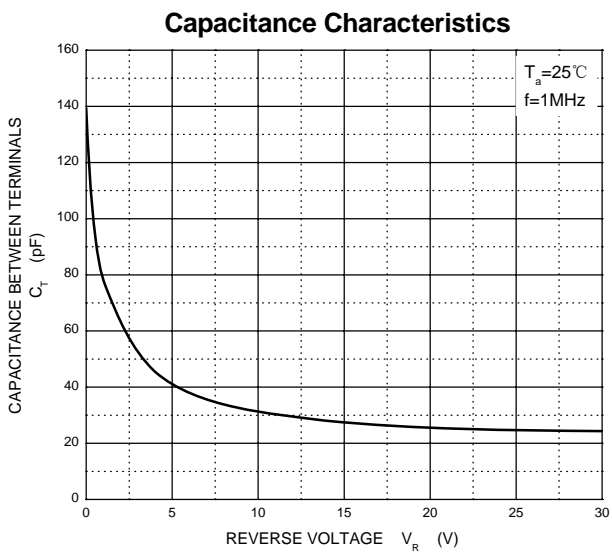
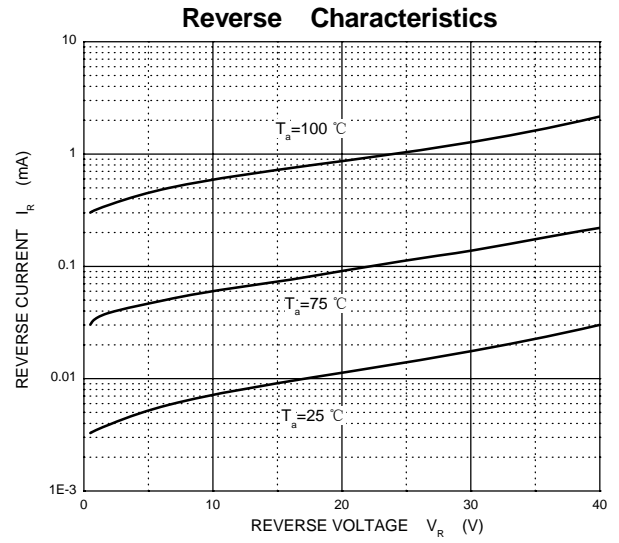
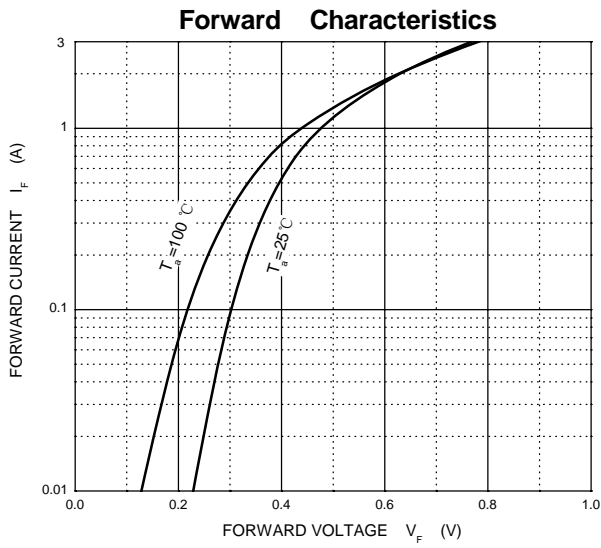

SOD-323 Package Outline Dimensions

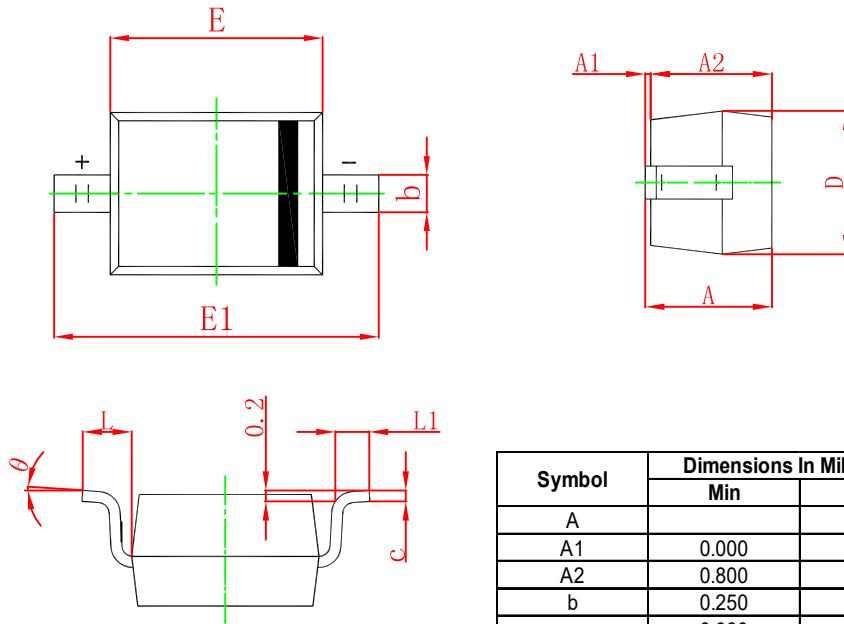

| Symbol | Dimensions In Millimeters | | Dimensions In Inches | |
|--------|---------------------------|-------|----------------------|-------|
| | Min | Max | Min | Max |
| A | | 1.100 | | 0.043 |
| A1 | 0.000 | 0.100 | 0.000 | 0.004 |
| A2 | 0.800 | 1.000 | 0.031 | 0.039 |
| b | 0.250 | 0.350 | 0.010 | 0.014 |
| c | 0.080 | 0.150 | 0.003 | 0.006 |
| D | 1.200 | 1.400 | 0.047 | 0.055 |
| E | 1.600 | 1.800 | 0.063 | 0.071 |
| E1 | 2.500 | 2.750 | 0.098 | 0.108 |
| L | 0.475 REF | | 0.019 REF | |
| L1 | 0.250 | 0.400 | 0.010 | 0.016 |
| θ | 0° | | 8° | |

SOD-323 Suggested Pad Layout

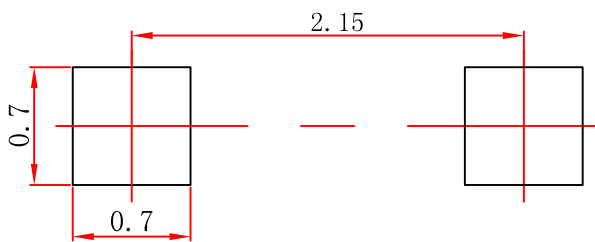

- Note:**
1. Controlling dimension: in millimeters.
 2. General tolerance: ± 0.05mm.
 3. The pad layout is for reference purposes only.

NOTICE

JSCJ reserves the right to make modifications, enhancements, improvements, corrections or other changes without further notice to any product herein. JSCJ does not assume any liability arising out of the application or use of any product described herein.

SOD-323 Tape and Reel

SOD-323 Embossed Carrier Tape



Packaging Description:

SOD-323 parts are shipped in tape. The carrier tape is made from a dissipative (carbon filled) polycarbonate resin. The cover tape is a multilayer film (Heat Activated Adhesive in nature) primarily composed of polyester film, adhesive layer, sealant, and anti-static sprayed agent. These reeled parts in standard option are shipped with 3,000 units per 7" or 17.8cm diameter reel. The reels are clear in color and is made of polystyrene plastic (anti-static coated).

| Dimensions are in millimeter | | | | | | | | | | |
|------------------------------|------|-----|------|-------|------|------|------|------|------|------|
| Pkg type | A | B | C | d | E | F | P0 | P | P1 | W |
| SOD-323 | 1.48 | 3.3 | 1.25 | Ø1.50 | 1.75 | 3.50 | 4.00 | 4.00 | 2.00 | 8.00 |

SOD-323 Tape Leader and Trailer

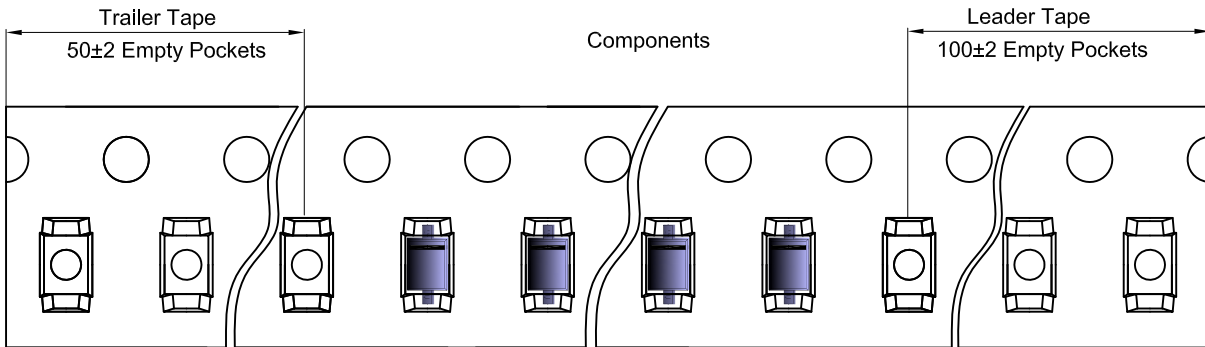

SOD-323 Reel

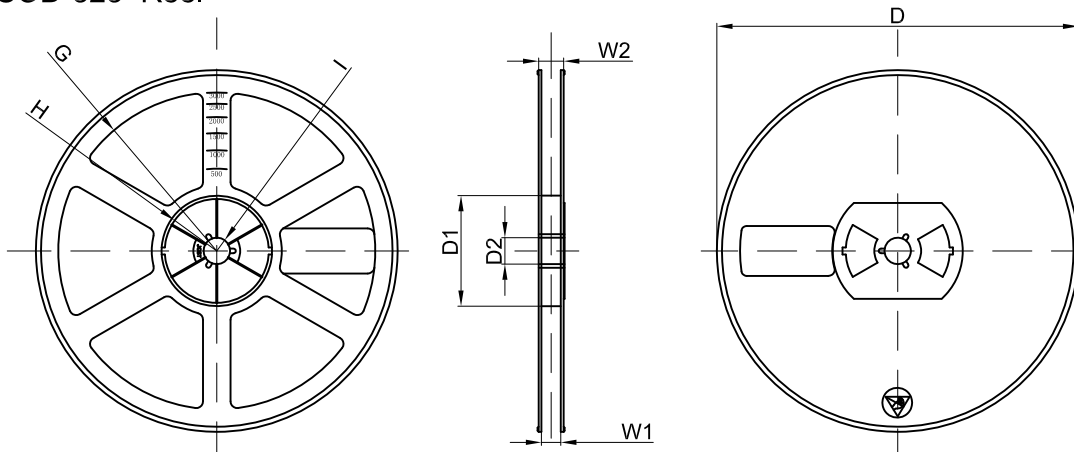

| Dimensions are in millimeter | | | | | | | | |
|------------------------------|---------|-------|-------|--------|--------|-------|------|-------|
| Reel Option | D | D1 | D2 | G | H | I | W1 | W2 |
| 7" Dia | Ø178.00 | 54.40 | 13.00 | R78.00 | R25.60 | R6.50 | 9.50 | 12.30 |

| REEL | Reel Size | Box | Box Size(mm) | Carton | Carton Size(mm) | G.W.(kg) |
|----------|-----------|------------|--------------|-------------|-----------------|----------|
| 3000 pcs | 7 inch | 45,000 pcs | 203×203×195 | 180,000 pcs | 438×438×220 | |

单击下面可查看定价，库存，交付和生命周期等信息

[>>JSCJ](#)