



Product Summary

$V_{(BR)DSS}$	$R_{DS(on)TYP}$	I_D
-20V	450mΩ@-4.5V	-0.66A
	650mΩ@-2.5V	
	950mΩ@-1.8V	
20V	190mΩ@4.5V	0.75A
	260mΩ@2.5V	
	390mΩ@1.8V	

Feature

- Surface Mount Package
- Low $R_{DS(on)}$
- Operated at Low Logic Level Gate Drive
- ESD Protected Gate

Application

- Load/ Power Switching
- Interfacing Switching
- Battery Management for Ultra Small Portable Electronics
- Logic Level Shift

MARKING:

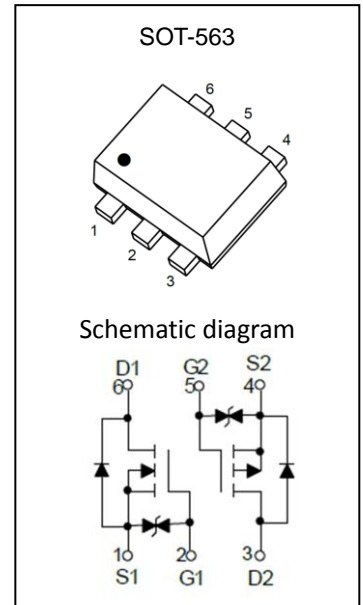
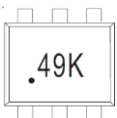

ABSOLUTE MAXIMUM RATINGS ($T_a=25^{\circ}\text{C}$ unless otherwise noted)

Parameter	Symbol	Value	Unit
P-MOSFET			
Drain-Source Voltage	V_{DS}	-20	V
Gate-Source Voltage	V_{GS}	± 12	V
Continuous Drain Current ⁽¹⁾	I_D	-0.66	A
Pulsed Drain Current ($t_p=10\mu\text{s}$)	I_{DM}	-1.2	A
N-MOSFET			
Drain-Source Voltage	V_{DS}	20	V
Gate-Source Voltage	V_{GS}	± 12	V
Continuous Drain Current ⁽¹⁾	I_D	0.75	A
Pulsed Drain Current($t_p=10\mu\text{s}$)	I_{DM}	1.8	A
Temperature and Thermal Resistance			
Thermal Resistance from Junction to Ambient ⁽¹⁾	$R_{\theta JA}$	833	$^{\circ}\text{C/W}$
Junction Temperature	T_J	150	$^{\circ}\text{C}$
Storage Temperature	T_{STG}	-55~ +150	$^{\circ}\text{C}$
Lead Temperature for Soldering Purposes(1/8" from case for 10s)	T_L	260	$^{\circ}\text{C}$

P-channel MOSFET ELECTRICAL CHARACTERISTICS(T_a=25°C unless otherwise noted)

Parameter	Symbol	Test Condition	Min	Type	Max	Unit
Static Characteristics						
Drain-source breakdown voltage	V _{(BR)DSS}	V _{GS} = 0V, I _D = -250μA	-20			V
Zero gate voltage drain current	I _{DSS}	V _{DS} = -20V, V _{GS} = 0V			-1	μA
Gate-body leakage current	I _{GSS}	V _{GS} = ±10V, V _{DS} = 0V			±20	μA
Gate threshold voltage ⁽²⁾	V _{GS(th)}	V _{DS} = V _{GS} , I _D = -250μA	-0.35	-0.60	-1.1	V
Drain-source on-resistance ⁽²⁾	R _{DS(on)}	V _{GS} = -4.5V, I _D = -1A		450	580	mΩ
		V _{GS} = -2.5V, I _D = -0.8A		650	840	
		V _{GS} = -1.8V, I _D = -0.5A		950		
Forward tranconductance ⁽²⁾	g _{FS}	V _{DS} = -10V, I _D = -0.54A		1.2		S
Diode forward voltage	V _{DS}	I _S = -0.5A, V _{GS} = 0V			-1.2	V
Dynamic characteristics⁽⁴⁾						
Input Capacitance	C _{iss}	V _{DS} = -16V, V _{GS} = 0V, f = 1MHz		113		pF
Output Capacitance	C _{oss}			15		
Reverse Transfer Capacitance	C _{rss}			9		
Switching Characteristics^(3,4)						
Turn-on delay time	t _{d(on)}	V _{DS} = -10V, I _D = -200mA, V _{GS} = -4.5V, R _G = 10Ω		9		ns
Turn-on rise time	t _r			5.7		
Turn-off delay time	t _{d(off)}			32.6		
Turn-off fall time	t _f			20.3		

N-channel MOSFET ELECTRICAL CHARACTERISTICS(T_a=25°C unless otherwise noted)

Parameter	Symbol	Test Condition	Min	Type	Max	Unit
Static Characteristics						
Drain-source breakdown voltage	V _{(BR)DSS}	V _{GS} = 0V, I _D = 250μA	20			V
Zero gate voltage drain current	I _{DSS}	V _{DS} = 20V, V _{GS} = 0V			1	μA
Gate-body leakage current	I _{GSS}	V _{GS} = ±10V, V _{DS} = 0V			±20	μA
Gate threshold voltage ⁽²⁾	V _{GS(th)}	V _{DS} = V _{GS} , I _D = 250μA	0.35	0.75	1.1	V
Drain-source on-resistance ⁽²⁾	R _{DS(on)}	V _{GS} = 4.5V, I _D = 650mA		190	260	mΩ
		V _{GS} = 2.5V, I _D = 550mA		260	360	
		V _{GS} = 1.8V, I _D = 450mA		390	590	
Forward tranconductance	g _{FS}	V _{DS} = 10V, I _D = 800mA		1.6		S
Diode Forward voltage ⁽³⁾	V _{DS}	I _S = 0.15A, V _{GS} = 0V			1.2	V
Dynamic characteristics⁽⁴⁾						
Input Capacitance	C _{iss}	V _{DS} = 16V, V _{GS} = 0V, f = 1MHz		79	120	pF
Output Capacitance	C _{oss}			13	20	
Reverse Transfer Capacitance	C _{rss}			9	15	
Switching Characteristics^(3,4)						
Turn-on delay time	t _{d(on)}	V _{DS} = 10V, I _D = 500mA, V _{GS} = 4.5V, R _G = 10Ω		6.7		ns
Turn-on rise time	t _r			4.8		
Turn-off delay time	t _{d(off)}			17.3		
Turn-off fall time	t _f			7.4		

Notes:

1. Surface mounted on FR4 board using the minimum recommended pad size.
2. Pulse Test : Pulse Width=300μs, Duty Cycle=2%.
3. Switching characteristics are independent of operating junction temperatures.
4. Guaranteed by design, not subject to producing.

Typical Electrical and Thermal Characteristics

P-Channel MOS

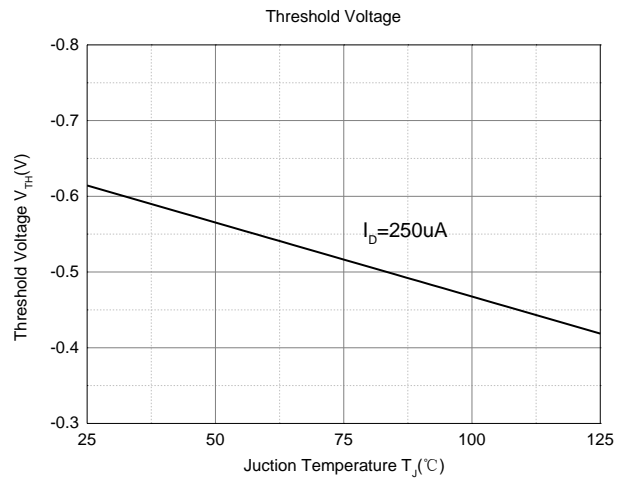
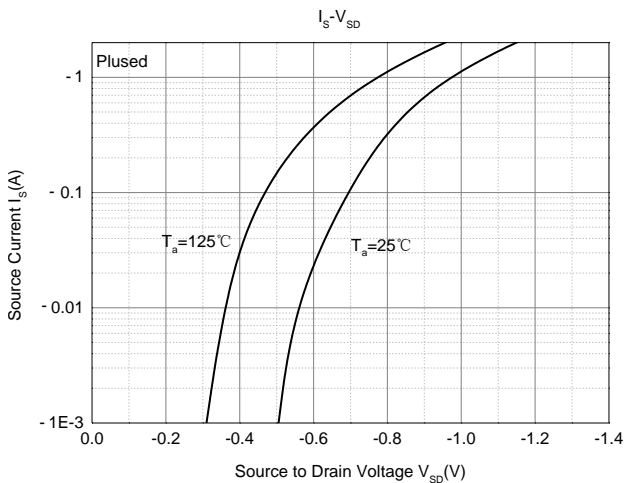
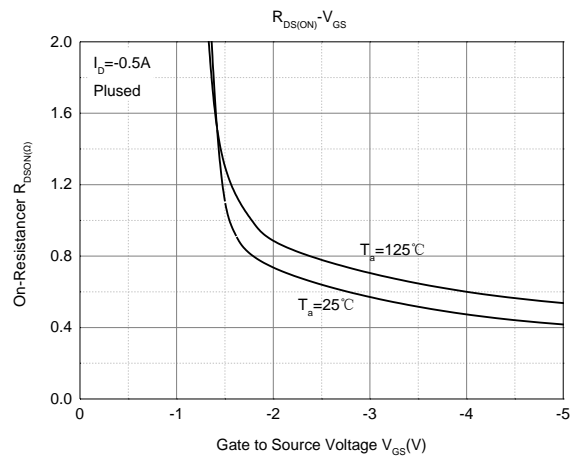
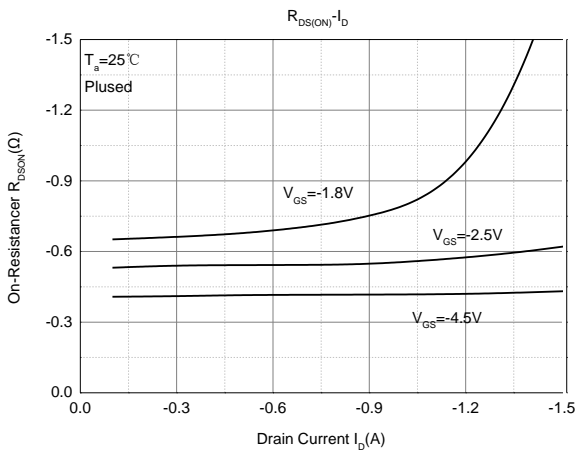
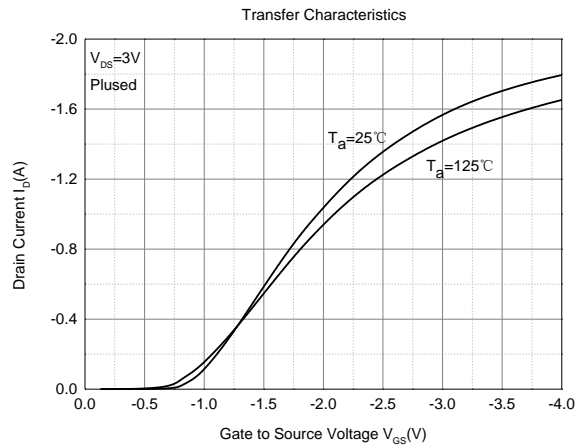
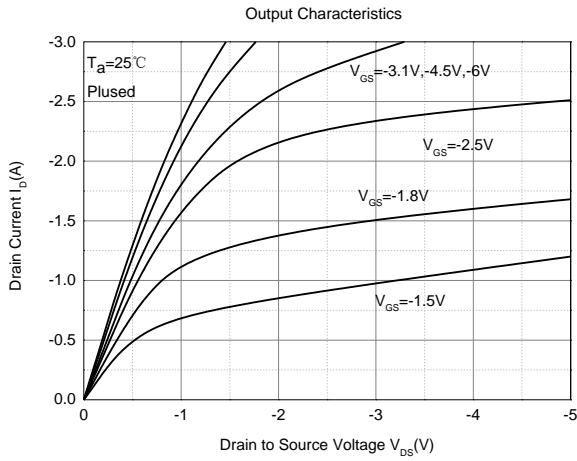

N-Channel MOS

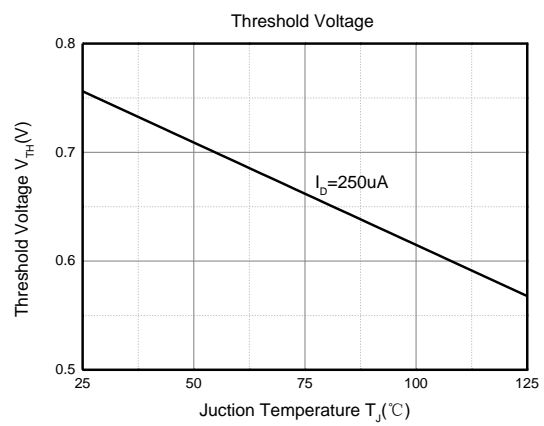
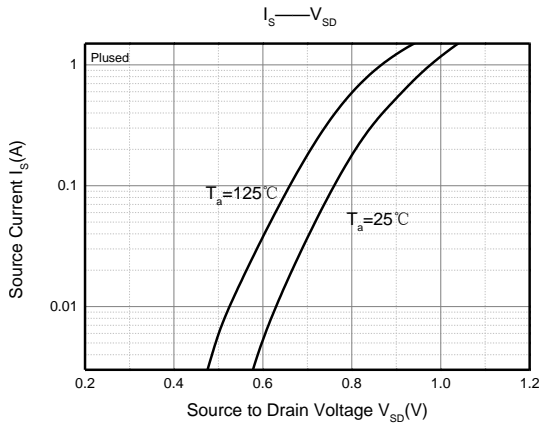
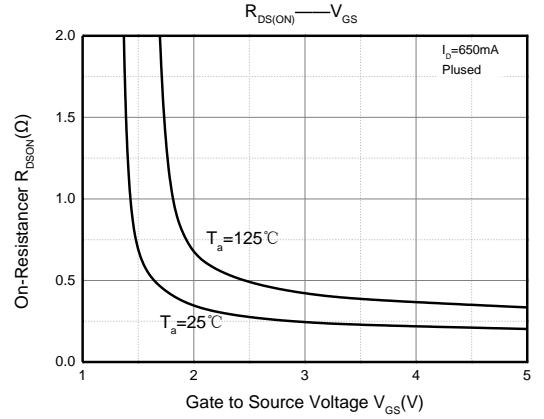
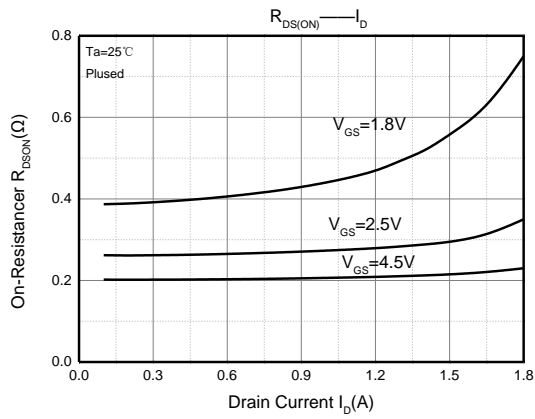
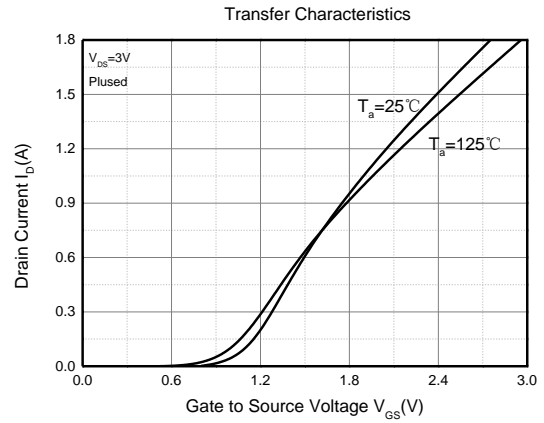
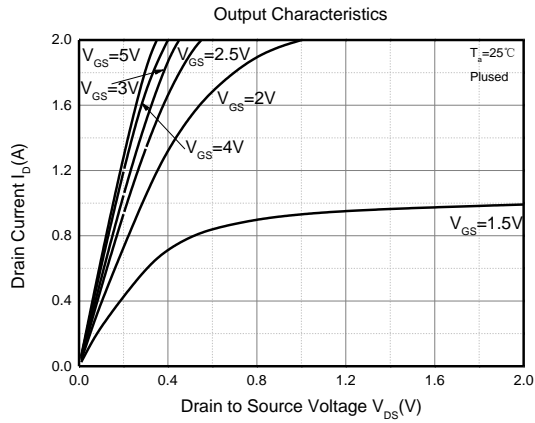

SOT-563 Package Information

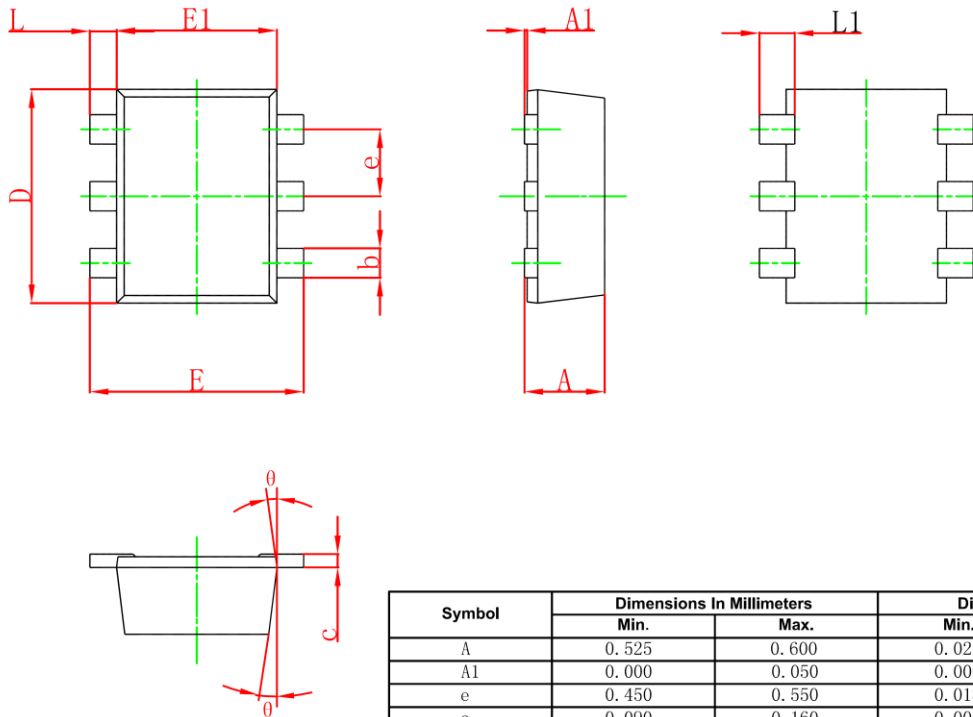

Symbol	Dimensions In Millimeters		Dimensions In Inches	
	Min.	Max.	Min.	Max.
A	0.525	0.600	0.021	0.024
A1	0.000	0.050	0.000	0.002
e	0.450	0.550	0.018	0.022
c	0.090	0.160	0.004	0.006
D	1.500	1.700	0.059	0.067
b	0.170	0.270	0.007	0.011
E1	1.100	1.300	0.043	0.051
E	1.500	1.700	0.059	0.067
L	0.100	0.300	0.004	0.012
L1	0.200	0.400	0.008	0.016
θ	7° REF.		7° REF.	

SOT-563 Tape and Reel

SOT-563 Tape and reel

SOT-563 Embossed Carrier Tape

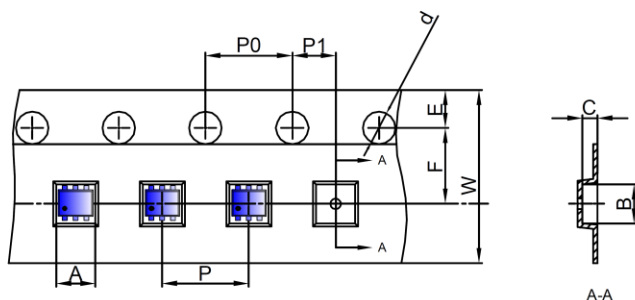

Dimensions are in millimeter											
Pkg type	A	B	C	d	E	F	P0	P	P1	W	
SOT-563	1.78	1.78	0.69	Ø1.50	1.75	3.50	4.00	4.00	2.00	8.00	

SOT-563 Tape Leader and Trailer

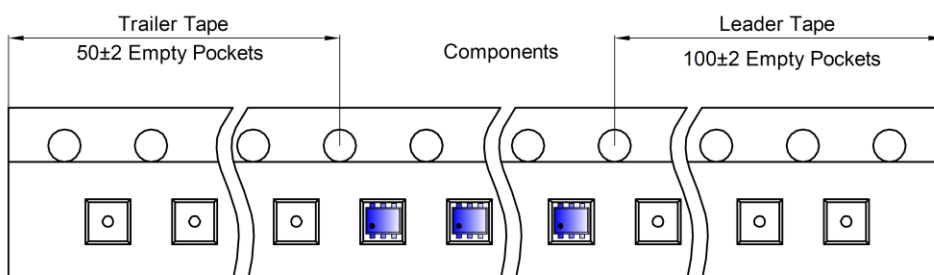

SOT-563 Reel

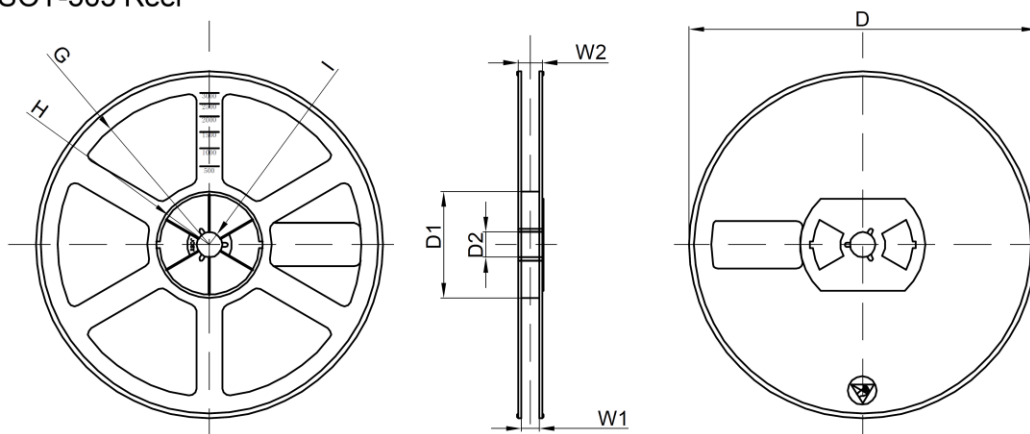

Dimensions are in millimeter								
Reel Option	D	D1	D2	G	H	I	W1	W2
7" Dia	Ø178.00	54.40	13.00	R78.00	R25.60	R6.50	9.50	12.30

REEL	Reel Size	Box	Box Size(mm)	Carton	Carton Size(mm)	G.W.(kg)
3000 pcs	7 inch	30,000 pcs	203×203×195	120,000 pcs	438×438×220	

单击下面可查看定价，库存，交付和生命周期等信息

[>>GP\(格瑞宝\)](#)