

The history of revision change for the specification

Document	REV.	Modified date	Description
CYNVC-175-017	A0	2017.5.16	New approval
CYNVC-175-017	A1	2017.6.19	1. May -> Jun. 2. Add spec of 1R5, 3R3, 5R6, 8R2 3. Add curve of 1R5, 3R3, 5R6, 8R2
CYNVC-175-017	A2	2018.3.13	1. Add "AEC-Q200" logo on page 2 2. Jun., 2017 -> Mar., 2018 3. Year code 2017 = 7 -> 2018 = 8
CYNVC-175-017	A3	2018.10.23	1. Mar. -> Oct. 2. Remove spec & curve of 560
CYNVC-175-017	A4	2020.1.21	1. Oct., 2018 -> Jan., 2020 2. Year code 2018 = 8 -> 2020 = 0 3. Add 560 spec and curve
CYNVC-175-017	A5	2020.6.15	1. Jan. -> Jun. 2. Add rated voltage
CYNVC-175-017	A6	2020.9.9	1. Jun. -> Sep. 2. Update Land Pattern B: 2.6 -> 2.55 ; C: 8.6 -> 9.26

Power Choke Coil VCHA075D MS6 type

AEC-Q200

■ Features

High performance (Isat) realized by metal dust core.
 Low profile : Thickness max. 5.4 mm
 Low loss realized with low DCR
 Compliance with RoHS and Halogen Free
 AEC-Q200 qualified

■ Application

Automotive applications

■ Outline Dimensions

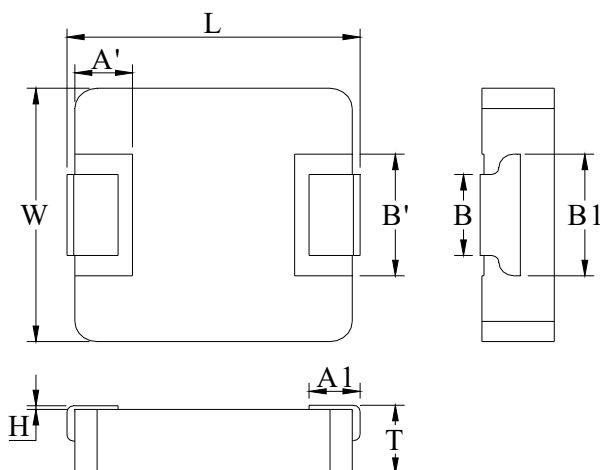

Code	Dimensions (mm)
L	7.70 ± 0.35
W	7.2 ± 0.3
T	5.2 ± 0.2
A1	2.0 ± 0.3
A'	2.1 ± 0.3
B	3.0 ± 0.3
B1	5.4 ± 0.3
B'	3.6 ± 0.3
H	0 ~ + 0.15

■ Recommend Land Pattern Dimensions

The customer shall determine the land dimensions shown below after confirming and safety.

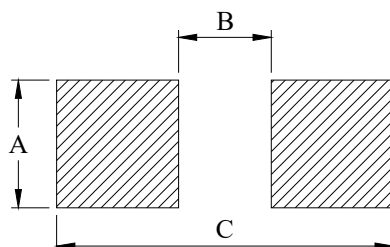

A	3.50
B	2.55
C	9.26

Unit : mm

■ **Marking and Date Code**

The point on the top surface represents winding direction of choke.

(1) **Marking**

The inductor is marked with a 3-digit code

Example -- 4.7 μ H \rightarrow 4R7

(2) **Date Code**

X XX

(1) (2)

XXX

(3)

Where (1) Year Code

Ex : 2020 = 0

(2) Weekly Code

Serial number : 01 ~ 53

(3) Taping No.

Serial number : 001 ~ ZZZ

Upside of Chip

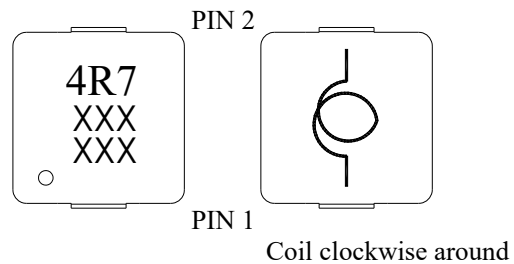

■ Specifications

Part Number	L0 ◇ Inductance (μ H) @ (0A)	R _{dc} (m Ω) ◇		Heat Rating Current DC Amps. I _{dc} (A)		Saturation Current DC Amps. I _{sat} (A)		Rated Voltage (V)
		Typical	Maximum	Typical	Maximum	Typical	Maximum	Maximum
VCHA075D-1R5MS6	1.5	6.1	7.3	11.4	10.3	16.3	14.0	80
VCHA075D-2R2MS6	2.2	9.5	11.4	9.7	8.7	14.8	12.7	80
VCHA075D-3R3MS6	3.3	14.0	15.4	8.0	7.2	13.5	11.6	80
VCHA075D-4R7MS6	4.7	19.0	20.9	7.0	6.3	13.1	11.2	80
VCHA075D-5R6MS6	5.6	21.5	24.0	6.5	5.9	10.6	9.1	80
VCHA075D-6R8MS6	6.8	24.2	26.6	6.1	5.5	10.2	8.7	80
VCHA075D-8R2MS6	8.2	29.0	31.9	5.6	5.0	9.0	7.7	80
VCHA075D-100MS6	10.0	34.5	38.0	5.2	4.7	8.0	6.9	80
VCHA075D-150MS6	15.0	60.0	66.0	3.8	3.4	6.9	5.9	80
VCHA075D-220MS6	22.0	85.0	93.5	3.3	3.0	6.3	5.4	80
VCHA075D-330MS6	33.0	116.0	127.6	3.2	2.8	4.9	4.2	80
VCHA075D-470MS6	47.0	156.0	171.6	2.4	2.2	4.1	3.5	80
VCHA075D-560MS6	56.0	182.0	209.3	2.2	2.0	3.3	2.8	80
VCHA075D-680MS6	68.0	222.0	255.0	2.0	1.8	2.8	2.4	80

◇ : Significant Characteristic

* : If you require another part number please contact with us.

** : Inductance Tolerance $\pm 20\%$

Note 1. : All test data is referenced to 25°C ambient.

Note 2. : Test Condition: 100KHz, 1.0Vrms

Note 3. : I_{dc} : DC current (A) that will cause an approximate ΔT of 40°C

Note 4. : I_{sat} : DC current (A) that will cause L0 to drop approximately 30%

Note 5. : Operating Temperature Range -55°C to +165°C

Note 6. : The part temperature (ambient + temp rise) should not exceed 165°C under the worst case operating conditions. Circuit design, component placement, PCB trace size and thickness, airflow and other cooling provision all affect the part temperature. Part temperature should be verified in the end application.

Note 7. : The rated current as listed is either the saturation current or the heating current depending on which value is lower.

Note 8. : Cleaning Process Note

(a) If this power choke is dipped in the cleaning agent, such as toluene, xylene, ketone, and ether system, there is a possibility that the performance decreases greatly

(b) The high power ultrasonic washing may damage the choke body.

(c) Please contact us if you need the cleaning via the above agents or ultrasonic washing.

Current Characteristic

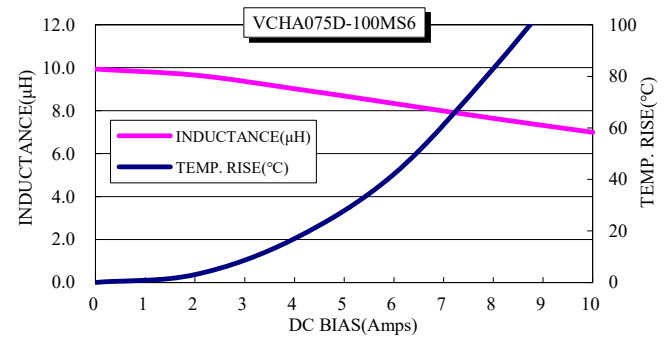
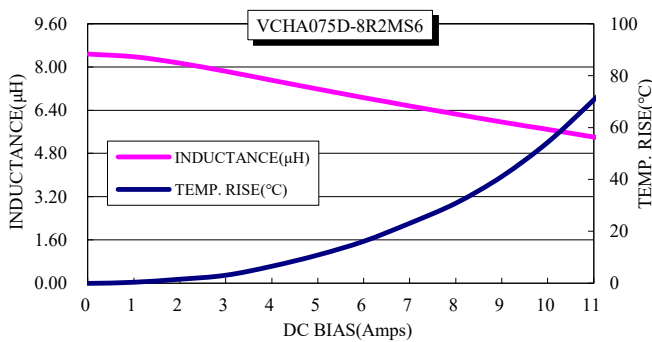
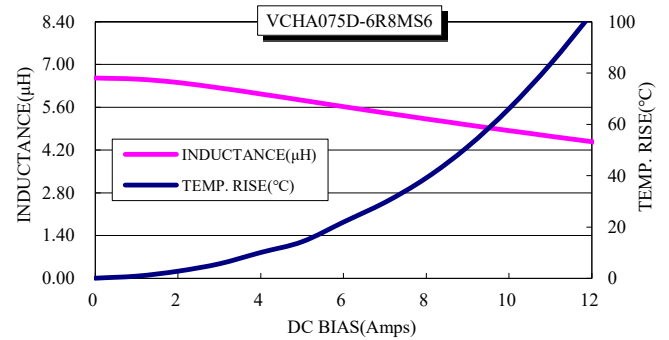
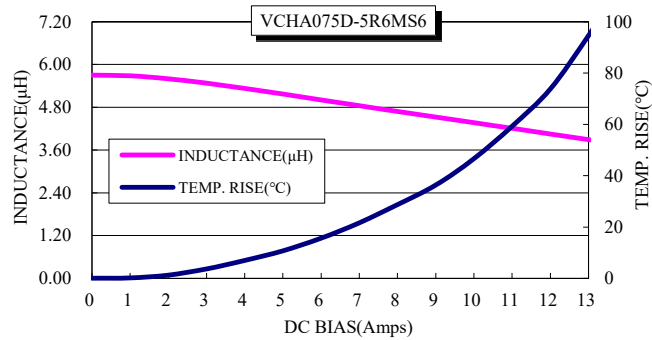
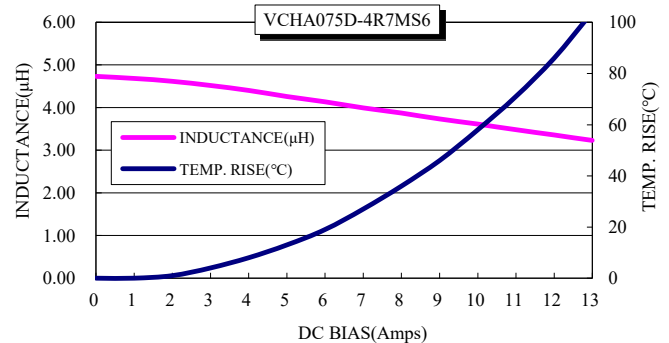
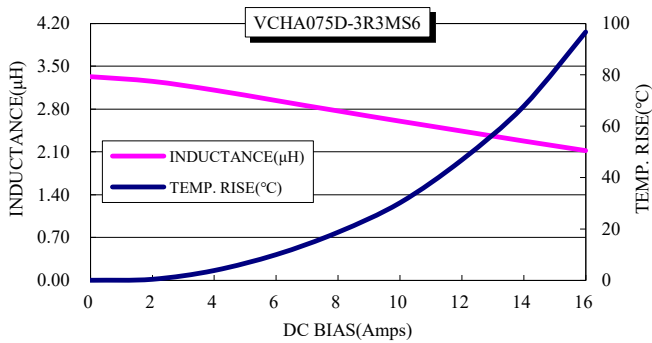
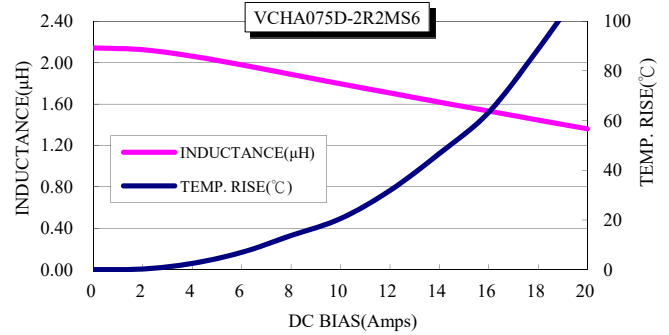
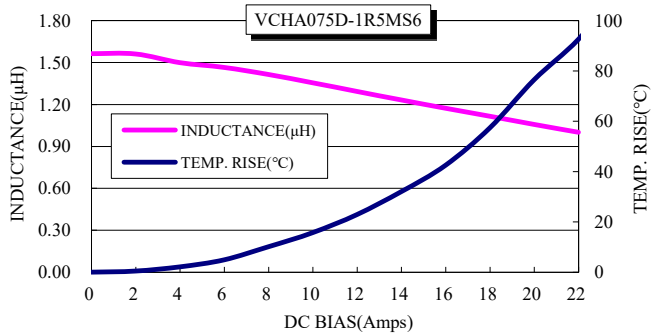

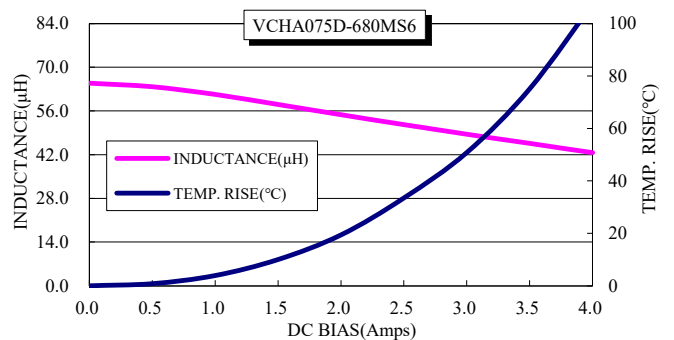
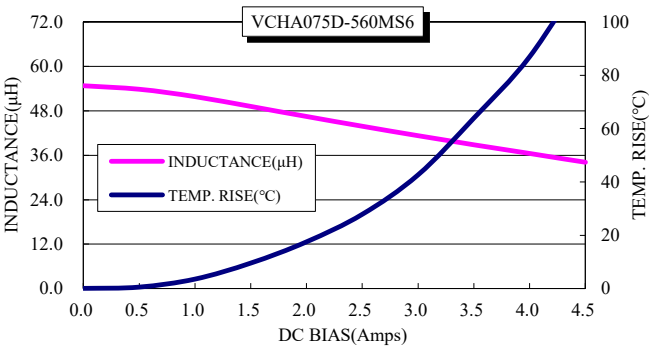
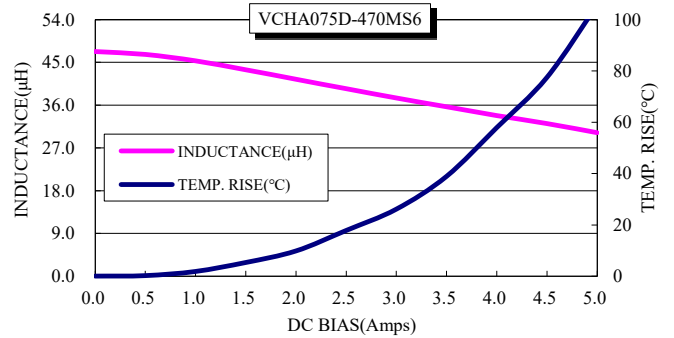
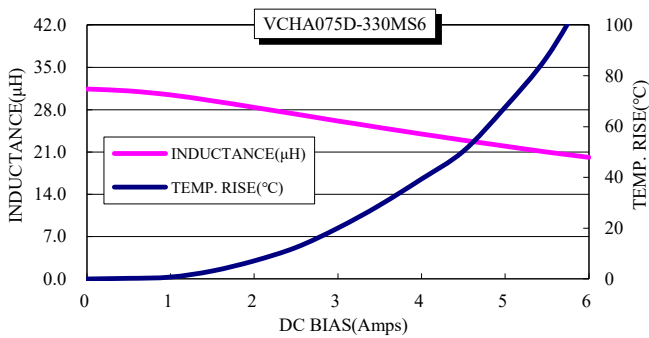
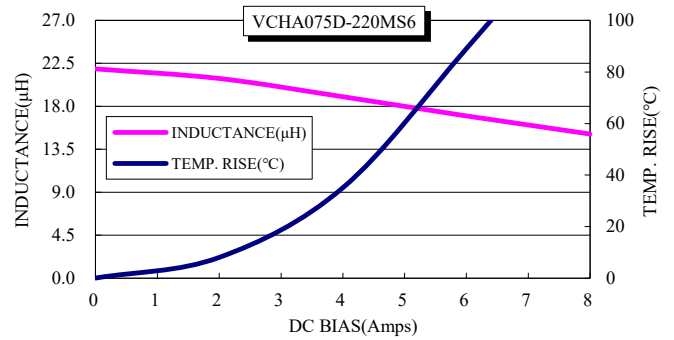
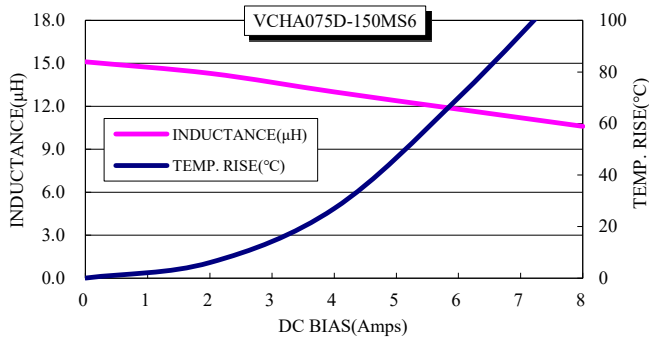

■ Packaging

(1) Tape packaging dimensions

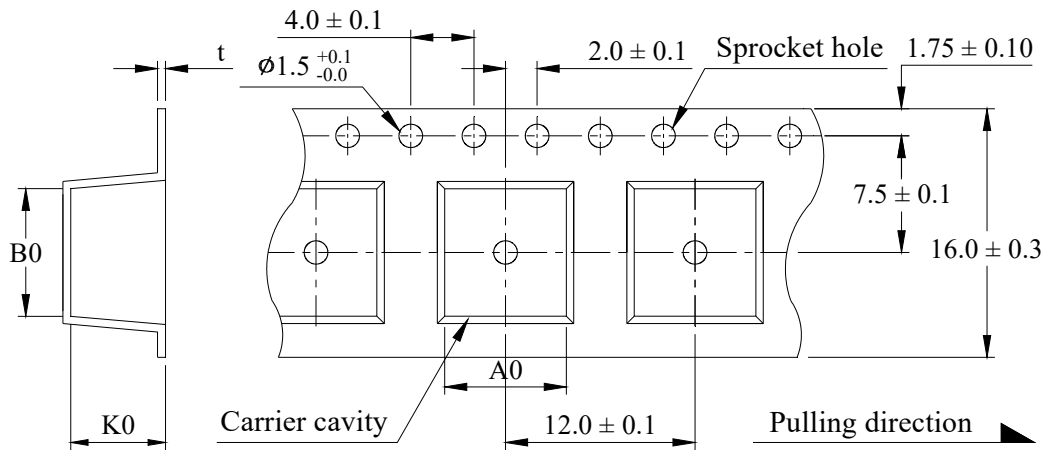

Dimensions Code (mm)				UNITS/REEL
A0	B0	K0	t	
7.7 ± 0.1	8.2 ± 0.1	6.0 ± 0.1	0.50 ± 0.05	500

(2) Tape Direction

The direction shall be seen from the top cover tape side.

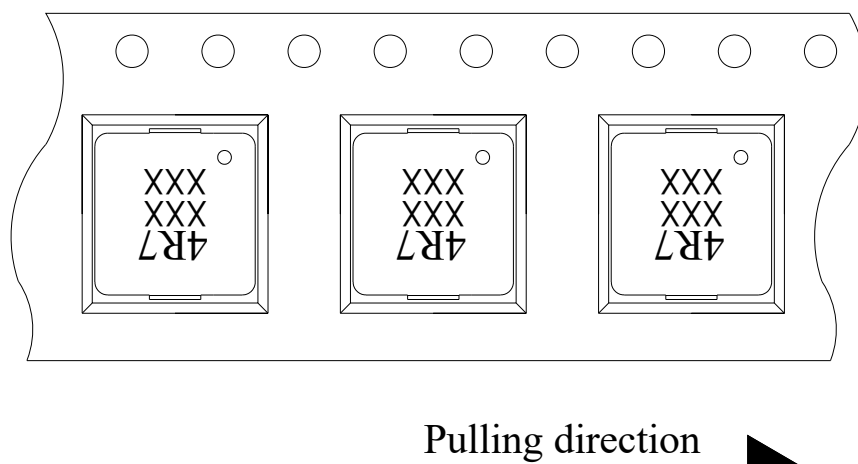

(3) Reel dimensions

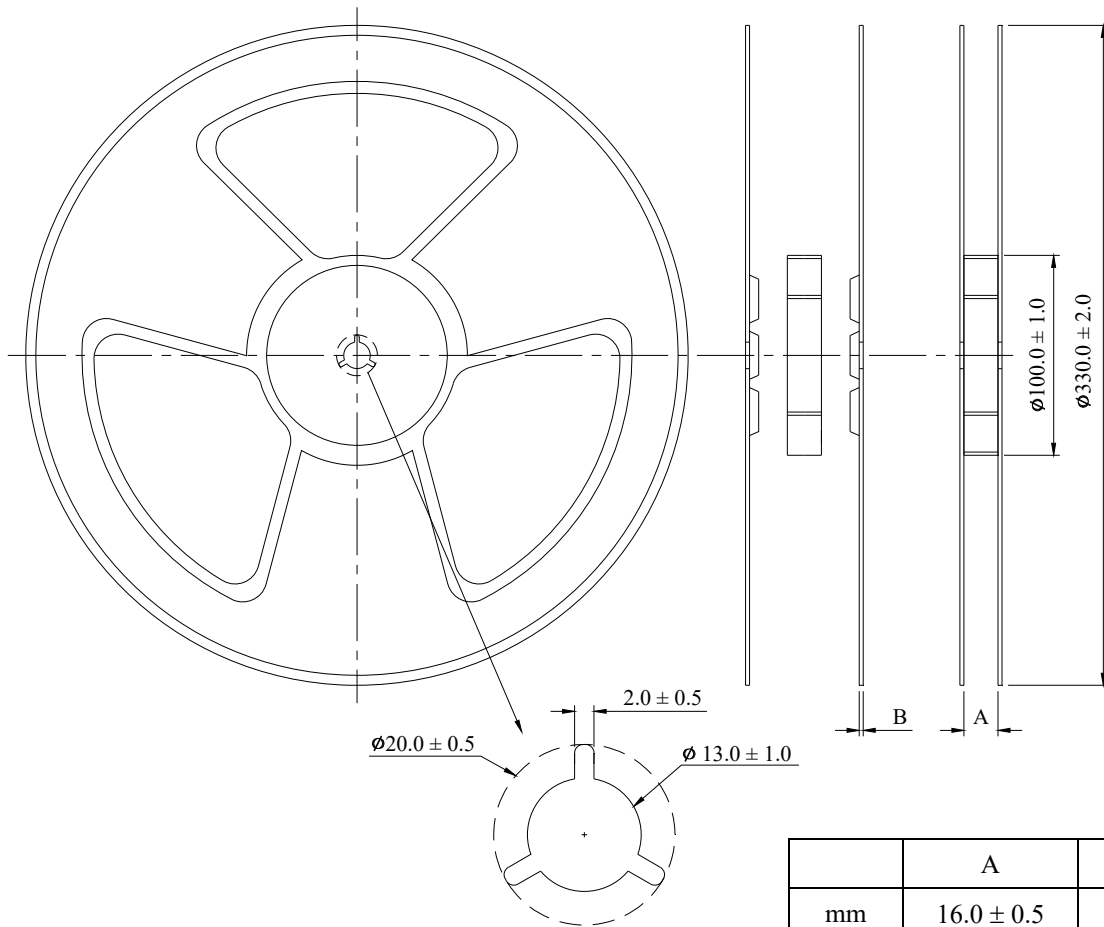

(4) Peel force of top cover tape

The peel speed shall be about 300 mm/minute.

The peel force of top cover tape shall be between 0.1 to 1.3N.

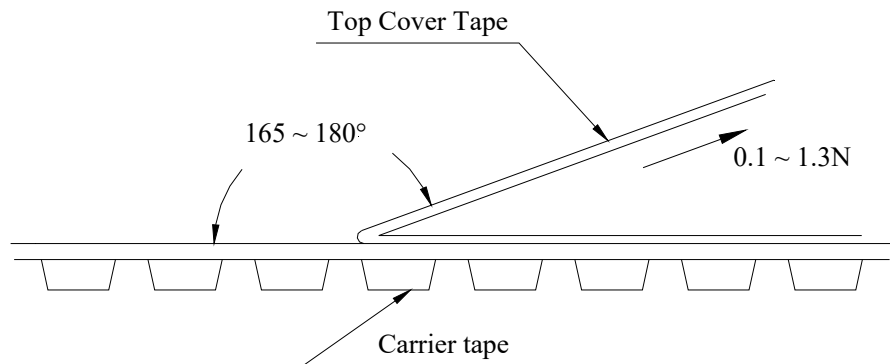

■ Reflow Profile

Power Choke Coil Type

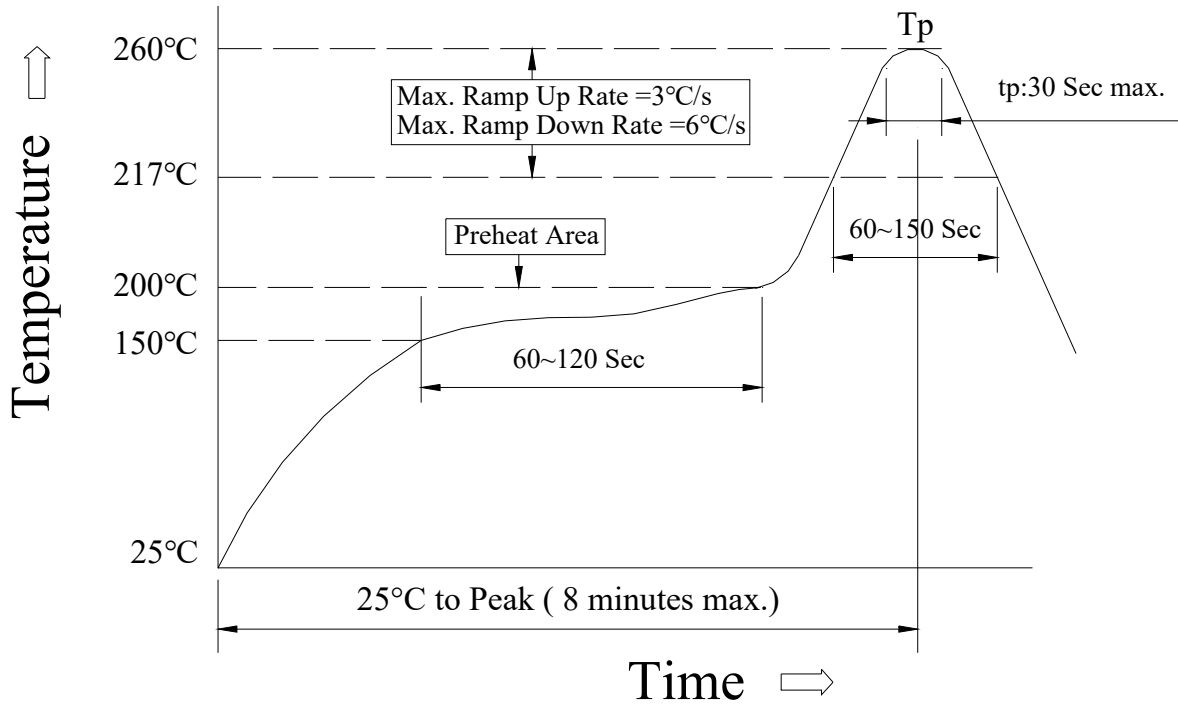

(1) Reflow Soldering Method :

Reflow Soldering	Tp:255~260°C	Max.30 seconds (tp)
	217°C	60~150 seconds
Pre-Heat	150 ~ 200°C	60~120 seconds
Time 25°C to peak temperature	8 minutes max.	

(2) Soldering iron Method : 350 ± 5°C max.3 seconds.

单击下面可查看定价，库存，交付和生命周期等信息

[>>CYNTEC\(乾坤科技\)](#)