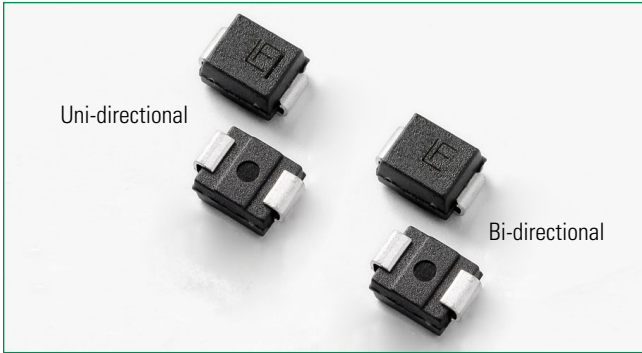


**SMBJ Series**



**Agency Approvals**

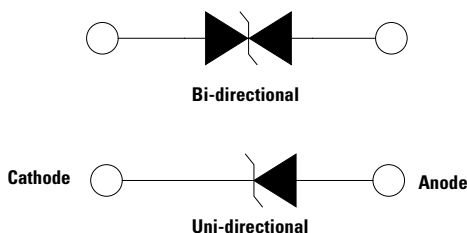
Agency	Agency File Number
	E230531

**Maximum Ratings and Thermal Characteristics  
(T<sub>A</sub>=25°C unless otherwise noted)**

Parameter	Symbol	Value	Unit
Peak Pulse Power Dissipation(Fig.2) by 10/1000us Test Waveform(Fig.4) (Note 1),(Note 2)-Single Die Parts	P <sub>PPM</sub>	600	W
Peak Pulse Power Dissipation(Fig.2) by 10/1000us Test Waveform(Fig.4) (Note 1), (Note 2)-Stacked Die Parts (Note 5)	P <sub>PPM</sub>	800	W
Power Dissipation on Infinite Heat Sink at T <sub>L</sub> =50°C	P <sub>D</sub>	5.0	W
Peak Forward Surge Current, 8.3ms Single Half Sine Wave (Note 3)	I <sub>FSM</sub>	100	A
Maximum Instantaneous Forward Voltage at 50A for Unidirectional Only (Note 4)	V <sub>F</sub>	3.5/5.0	V
Operating Temperature Range	T <sub>J</sub>	-65 to 150	°C
Storage Temperature Range	T <sub>STG</sub>	-65 to 175	°C
Typical Thermal Resistance Junction to Lead	R <sub>θJL</sub>	20	°C/W
Typical Thermal Resistance Junction to Ambient	R <sub>θJA</sub>	100	°C/W

- Notes:**
1. Non-repetitive current pulse , per Fig. 4 and derated above T<sub>J</sub> (initial) =25°C per Fig. 3.
  2. Mounted on copper pad area of 0.2x0.2" (5.0 x 5.0mm) to each terminal.
  3. Measured on 8.3ms single half sine wave or equivalent square wave for unidirectional device only, duty cycle=4 per minute maximum.
  4. V<sub>F</sub> < 3.5V for single die parts and V<sub>F</sub> < 5.0V for stacked-die parts.
  5. For stacked die component details, please refer to part numbers labeled by \* in Electrical Characteristics.

**Functional Diagram**



**Description**

The SMBJ series is designed specifically to protect sensitive electronic equipment from voltage transients induced by lightning and other transient voltage events.


**Features**

- Excellent clamping capability
- Low incremental surge resistance
- Typical I<sub>R</sub> less than 1μA when V<sub>BR</sub> min>12V
- For surface mounted applications to optimize board space
- Low profile package
- Typical failure mode is short from over-specified voltage or current
- Whisker test is conducted based on JEDEC JESD201A per its table 4a and 4c
- IEC-61000-4-2 ESD 30kV(Air), 30kV (Contact)
- ESD protection of data lines in accordance with IEC 61000-4-2
- EFT protection of data lines in accordance with IEC 61000-4-4
- Built-in strain relief
- Fast response time: typically less than 1.0ps from 0V to VBR min
- 600W peak pulse power capability at 10/1000μs waveform, repetition rate (duty cycles):0.01%
- High temperature to reflow soldering guaranteed: 260°C/30sec
- V<sub>BR</sub> @ T<sub>J</sub> = V<sub>BR</sub> @25°C x (1 + α T x (T<sub>J</sub> - 25)) (α T:Temperature Coefficient, typical value is 0.1%)
- UL Recognized compound meeting flammability classification V-0
- Meet MSL level1, per J-STD-020, LF maximum peak of 260°C
- Matte tin lead-free plated
- Halogen free and RoHS compliant
- Pb-free E3 means 2nd level interconnect is Pb-free and the terminal finish material is tin(Sn) (IPC/ JEDEC J-STD-609A.01)
- UL Recognized to ANSI/UL 497B: Protectors for Data Communications and Fire-Alarm Circuits.

**Applications**

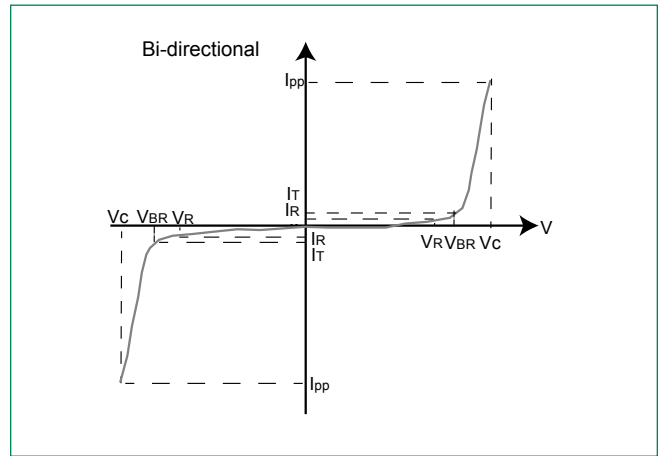
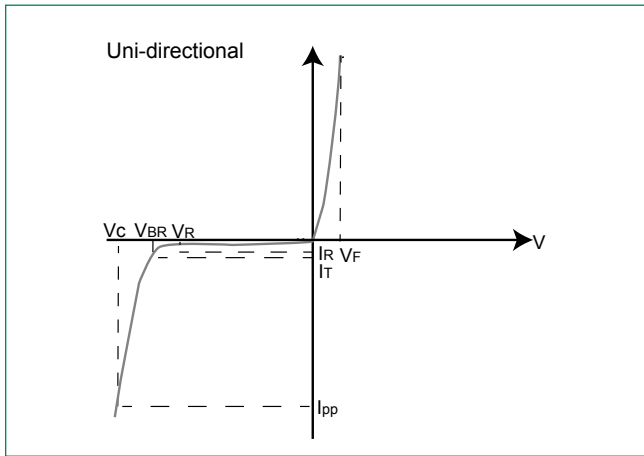
TVS components are ideal for the protection of I/O Interfaces, V<sub>CC</sub> bus and other vulnerable circuits used in Telecom, Computer, Industrial and Consumer electronic applications.

**Electrical Characteristics** ( $T_A=25^\circ\text{C}$  unless otherwise noted)

Part Number (Uni)	Part Number (Bi)	Marking		Reverse Stand off Voltage $V_R$ (Volts)	Breakdown Voltage $V_{BR}$ (Volts) @ $I_T$		Test Current $I_T$ (mA)	Maximum Clamping Voltage $V_C$ @ $I_{PP}$ (V)	Maximum Peak Pulse Current $I_{PP}$ (A)	Maximum Reverse Leakage $I_R$ @ $V_R$ ( $\mu\text{A}$ )	Maximum Temperature coefficient of $V_{BR}$ (%/C)	Agency Approval 
		UNI	BI		MIN	MAX						
SMBJ5.0A	SMBJ5.0CA	KE	AE	5.0	6.40	7.00	10	9.2	65.3	800	0.041	X
SMBJ6.0A	SMBJ6.0CA	KG	AG	6.0	6.67	7.37	10	10.3	58.3	800	0.046	X
SMBJ6.5A	SMBJ6.5CA	KK	AK	6.5	7.22	7.98	10	11.2	53.6	500	0.052	X
SMBJ7.0A	SMBJ7.0CA	KM	AM	7.0	7.78	8.60	10	12.0	50.0	200	0.058	X
SMBJ7.5A	SMBJ7.5CA	KP	AP	7.5	8.33	9.21	1	12.9	46.6	100	0.061	X
SMBJ8.0A	SMBJ8.0CA	KR	AR	8.0	8.89	9.83	1	13.6	44.2	50	0.064	X
SMBJ8.5A	SMBJ8.5CA	KT	AT	8.5	9.44	10.40	1	14.4	41.7	20	0.066	X
SMBJ9.0A	SMBJ9.0CA	KV	AV	9.0	10.00	11.10	1	15.4	39.0	10	0.069	X
SMBJ10A	SMBJ10CA	KX	AX	10.0	11.10	12.30	1	17.0	35.3	5	0.071	X
SMBJ11A	SMBJ11CA	KZ	AZ	11.0	12.20	13.50	1	18.2	33.0	1	0.074	X
SMBJ12A	SMBJ12CA	LE	BE	12.0	13.30	14.70	1	19.9	30.2	1	0.075	X
SMBJ13A	SMBJ13CA	LG	BG	13.0	14.40	15.90	1	21.5	28.0	1	0.076	X
SMBJ14A	SMBJ14CA	LK	BK	14.0	15.60	17.20	1	23.2	25.9	1	0.080	X
SMBJ15A	SMBJ15CA	LM	BM	15.0	16.70	18.50	1	24.4	24.6	1	0.083	X
SMBJ16A	SMBJ16CA	LP	BP	16.0	17.80	19.70	1	26.0	23.1	1	0.084	X
SMBJ17A	SMBJ17CA	LR	BR	17.0	18.90	20.90	1	27.6	21.8	1	0.085	X
SMBJ18A	SMBJ18CA	LT	BT	18.0	20.00	22.10	1	29.2	20.6	1	0.088	X
SMBJ20A	SMBJ20CA	LV	BV	20.0	22.20	24.50	1	32.4	18.6	1	0.091	X
SMBJ22A	SMBJ22CA	LX	BX	22.0	24.40	26.90	1	35.5	16.9	1	0.092	X
SMBJ24A	SMBJ24CA	LZ	BZ	24.0	26.70	29.50	1	38.9	15.5	1	0.092	X
SMBJ26A	SMBJ26CA	ME	CE	26.0	28.90	31.90	1	42.1	14.3	1	0.093	X
SMBJ28A	SMBJ28CA	MG	CG	28.0	31.10	34.40	1	45.4	13.3	1	0.094	X
SMBJ30A	SMBJ30CA	MK	CK	30.0	33.30	36.80	1	48.4	12.4	1	0.096	X
SMBJ33A	SMBJ33CA	MM	CM	33.0	36.70	40.60	1	53.3	11.3	1	0.097	X
SMBJ36A	SMBJ36CA	MP	CP	36.0	40.00	44.20	1	58.1	10.4	1	0.098	X
SMBJ40A	SMBJ40CA	MR	CR	40.0	44.40	49.10	1	64.5	9.3	1	0.099	X
SMBJ43A	SMBJ43CA	MT	CT	43.0	47.80	52.80	1	69.4	8.7	1	0.100	X
SMBJ45A	SMBJ45CA	MV	CV	45.0	50.00	55.30	1	72.7	8.3	1	0.101	X
SMBJ48A	SMBJ48CA	MX	CX	48.0	53.30	58.90	1	77.4	7.8	1	0.101	X
SMBJ51A	SMBJ51CA	MZ	CZ	51.0	56.70	62.70	1	82.4	7.3	1	0.101	X
SMBJ54A	SMBJ54CA	NE	DE	54.0	60.00	66.30	1	87.1	6.9	1	0.102	X
SMBJ58A	SMBJ58CA	NG	DG	58.0	64.40	71.20	1	93.6	6.5	1	0.103	X
SMBJ60A	SMBJ60CA	NK	DK	60.0	66.70	73.70	1	96.8	6.2	1	0.103	X
SMBJ64A	SMBJ64CA	NM	DM	64.0	71.10	78.60	1	103.0	5.9	1	0.104	X
SMBJ70A	SMBJ70CA	NP	DP	70.0	77.80	86.00	1	113.0	5.3	1	0.105	X
SMBJ75A	SMBJ75CA	NR	DR	75.0	83.30	92.10	1	121.0	5.0	1	0.106	X
SMBJ78A	SMBJ78CA	NT	DT	78.0	86.70	95.80	1	126.0	4.8	1	0.106	X
SMBJ85A	SMBJ85CA	NV	DV	85.0	94.40	104.00	1	137.0	4.4	1	0.106	X
SMBJ90A	SMBJ90CA	NX	DX	90.0	100.00	111.00	1	146.0	4.1	1	0.107	X
SMBJ100A	SMBJ100CA	NZ	DZ	100.0	111.00	123.00	1	162.0	3.7	1	0.107	X
SMBJ110A	SMBJ110CA	PE	EE	110.0	122.00	135.00	1	177.0	3.4	1	0.107	X
SMBJ120A	SMBJ120CA	PG	EG	120.0	133.00	147.00	1	193.0	3.1	1	0.108	X
SMBJ130A	SMBJ130CA	PK	EK	130.0	144.00	159.00	1	209.0	2.9	1	0.108	X
SMBJ150A	SMBJ150CA	PM	EM	150.0	167.00	185.00	1	243.0	2.5	1	0.108	X
SMBJ160A	SMBJ160CA	PP	EP	160.0	178.00	197.00	1	259.0	2.3	1	0.108	X
SMBJ170A	SMBJ170CA	PR	ER	170.0	189.00	209.00	1	275.0	2.2	1	0.108	X
SMBJ180A	SMBJ180CA	PT	ET	180.0	201.00	222.00	1	292.0	2.1	1	0.108	X
SMBJ188A	SMBJ188CA	PB	EB	188.0	209.00	231.00	1	304.0	2.0	1	0.110	X
SMBJ200A	SMBJ200CA	PV	EV	200.0	224.00	247.00	1	324.0	1.9	1	0.110	X
SMBJ220A	SMBJ220CA	PX	EX	220.0	246.00	272.00	1	356.0	1.7	1	0.110	X
SMBJ250A	SMBJ250CA	PZ	EZ	250.0	279.00	309.00	1	405.0	1.5	1	0.110	X
SMBJ300A*	SMBJ300CA*	QE	FE	300.0	335.00	371.00	1	486.0	1.7	1	0.112	X
SMBJ350A*	SMBJ350CA*	QG	FG	350.0	391.00	432.00	1	567.0	1.5	1	0.112	X
SMBJ400A*	SMBJ400CA*	QK	FK	400.0	447.00	494.00	1	648.0	1.3	1	0.112	X
SMBJ440A*	SMBJ440CA*	QM	FM	440.0	492.00	543.00	1	713.0	1.1	1	0.112	X

**Notes:**  
 For bidirectional type having  $V_R$  of 10 volts and less, the  $I_R$  limit is double.  
 For stack-die parts, use \* to label the part number.

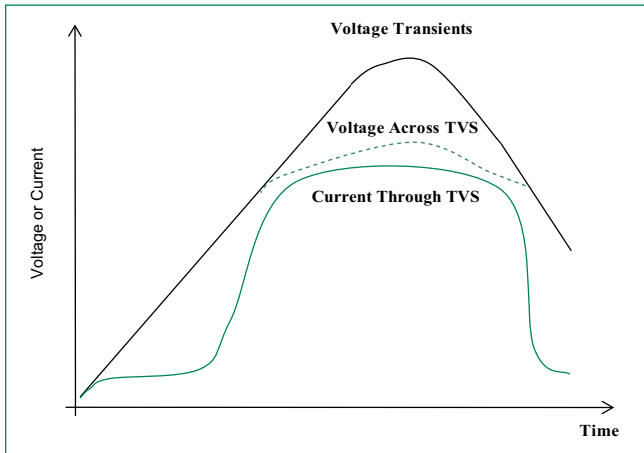
**I-V Curve Characteristics**



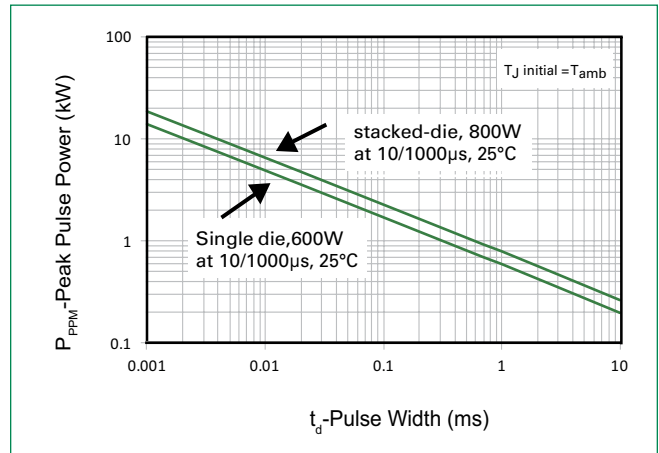
- $P_{PPM}$  Peak Pulse Power Dissipation** – Max power dissipation
- $V_s$  Stand-off Voltage** – Maximum voltage that can be applied to the TVS without operation
- $V_{BR}$  Breakdown Voltage** – Maximum voltage that flows through the TVS at a specified test current ( $I_T$ )
- $V_C$  Clamping Voltage** – Peak voltage measured across the TVS at a specified  $I_{ppm}$  (peak impulse current)
- $I_R$  Reverse Leakage Current** – Current measured at  $V_s$
- $V_F$  Forward Voltage Drop for Uni-directional**

**Ratings and Characteristic Curves** ( $T_A=25^\circ\text{C}$  unless otherwise noted)

**Figure 1 - TVS Transients Clamping Waveform**

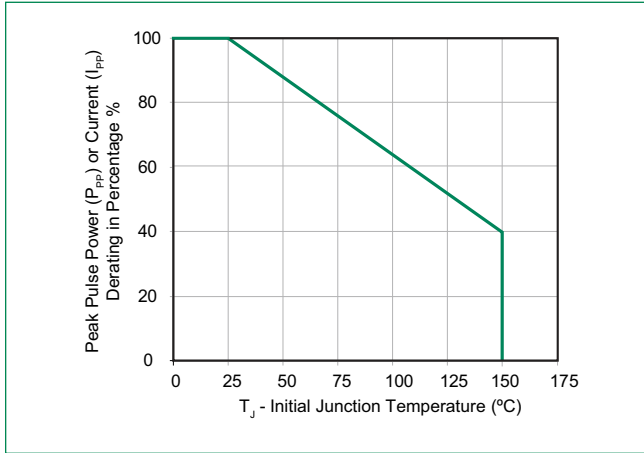


**Figure 2 - Peak Pulse Power Rating**



**Ratings and Characteristic Curves** ( $T_A=25^\circ\text{C}$  unless otherwise noted) (Continued)

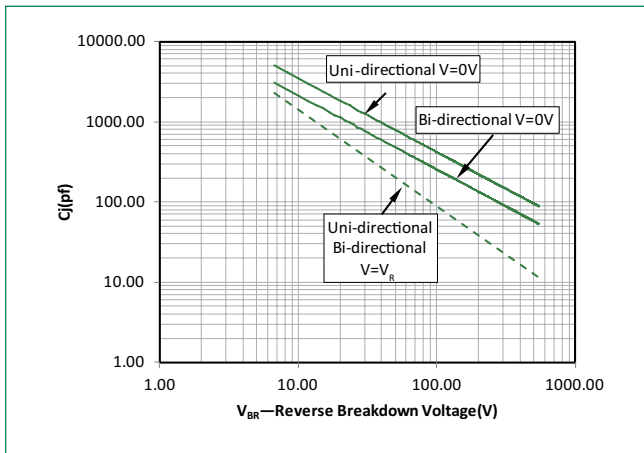
**Figure 3 - Peak Pulse Power Derating Curve**



**Figure 4 - Pulse Waveform**



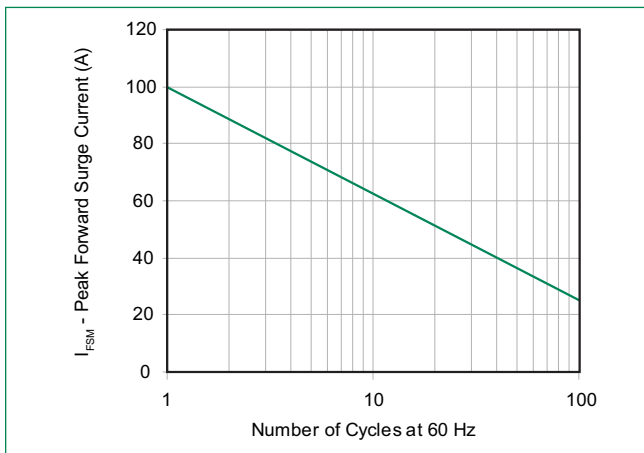
**Figure 5 - Typical Junction Capacitance**



**Figure 6 - Typical Transient Thermal Impedance**



**Figure 7 - Maximum Non-Repetitive Peak Forward Surge Current Uni-Directional Only**

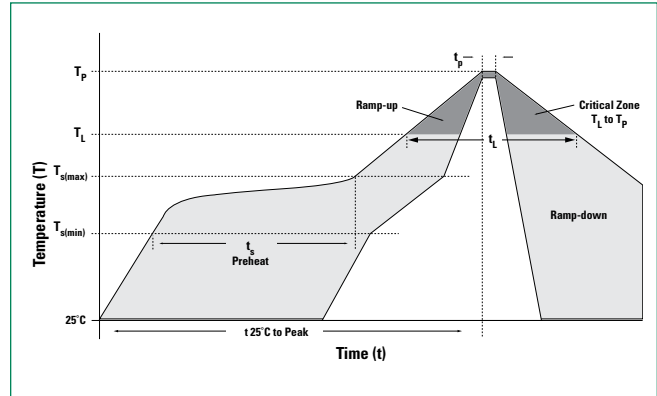


**Figure 8 - Peak Forward Voltage Drop vs Peak Forward Current (Typical Values)**



**Soldering Parameters**

<b>Reflow Condition</b>		Lead-free assembly
<b>Pre Heat</b>	- Temperature Min ( $T_{s(min)}$ )	150°C
	- Temperature Max ( $T_{s(max)}$ )	200°C
	- Time (min to max) ( $t_s$ )	60 – 120 secs
<b>Average ramp up rate (Liquidus Temp (<math>T_L</math>) to peak)</b>		3°C/second max
<b><math>T_{s(max)}</math> to <math>T_L</math> - Ramp-up Rate</b>		3°C/second max
<b>Reflow</b>	- Temperature ( $T_L$ ) (Liquidus)	217°C
	- Time (min to max) ( $t_L$ )	60 – 150 seconds
<b>Peak Temperature (<math>T_p</math>)</b>		260 <sup>+0/-5</sup> °C
<b>Time within 5°C of actual peak Temperature (<math>t_p</math>)</b>		30 seconds max
<b>Ramp-down Rate</b>		6°C/second max
<b>Time 25°C to peak Temperature (<math>T_p</math>)</b>		8 minutes Max.
<b>Do not exceed</b>		260°C



**Physical Specifications**

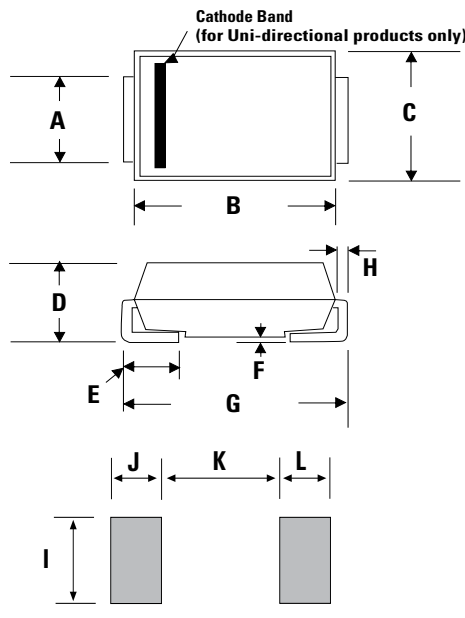
<b>Weight</b>	0.003 ounce, 0.093 grams
<b>Case</b>	JEDEC DO214AA. Molded plastic body over glass passivated junction
<b>Polarity</b>	Color band denotes cathode except Bidirectional
<b>Terminal</b>	Matte Tin-plated leads, Solderable per JESD22-B102

**Environmental Specifications**

<b>High Temp. Storage</b>	JESD22-A103
<b>HTRB</b>	JESD22-A108
<b>Temperature Cycling</b>	JESD22-A104
<b>MSL</b>	JEDEC-J-STD-020, Level 1
<b>H3TRB</b>	JESD22-A101
<b>RSH</b>	JESD22-A111

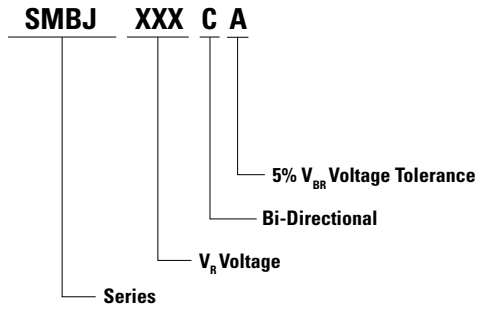
**Dimensions**

**DO-214AA (SMB J-Bend)**



Dimensions	Inches		Millimeters	
	Min	Max	Min	Max
A	0.076	0.086	1.930	2.200
B	0.160	0.187	4.060	4.750
C	0.130	0.155	3.300	3.940
D	0.078	0.103	1.990	2.610
E	0.030	0.060	0.760	1.520
F	-	0.008	-	0.203
G	0.205	0.220	5.210	5.590
H	0.006	0.012	0.152	0.305
I	0.089	-	2.260	-
J	0.085	-	2.160	-
K	-	0.107	-	2.740
L	0.085	-	2.160	-

**Part Numbering System**



**Part Marking System**



**Packaging**

Part number	Component Package	Quantity	Packaging Option	Packaging Specification
SMBJxxxXX	DO-214AA	3000	Tape & Reel - 12mm tape/13" reel	EIA STD RS-481

**Tape and Reel Specification**



**Disclaimer Notice** - Information furnished is believed to be accurate and reliable. However, users should independently evaluate the suitability of and test each product selected for their own applications. Littelfuse products are not designed for, and may not be used in, all applications. Read complete Disclaimer Notice at: [www.littelfuse.com/disclaimer-electronics](http://www.littelfuse.com/disclaimer-electronics)

© 2020 Littelfuse, Inc.  
Specifications are subject to change without notice.  
Revised: 06/03/20

单击下面可查看定价，库存，交付和生命周期等信息

[>>Littelfuse\(美国力特\)](#)