

**FEATURES**

- ※BCD, Hexadecimal
- ※Cross-head& Flat-head Actuator
- ※Washable

**APPLICATION**

- ※Steering system
- ※White goods
- ※Wireless microphone

**SPECIFICATION**

Contact Rating	150mA, 24V DC
Contact Resistance	80mΩ max.
Insulation Resistance	100MΩ min. 250V DC
Dielectric Strength	250V AC/1 minute
Operating Force	400gf·cm max.
Operating Life	10,000 steps
Operating Temp.	-60°C ~ +125°C
Storage Temp.	-60°C ~ +125°C

**PACKAGE**

<Tube>  
47 pcs  
<Tape & Reel>  
RBM: 450 pcs.

**HOW TO ORDER**

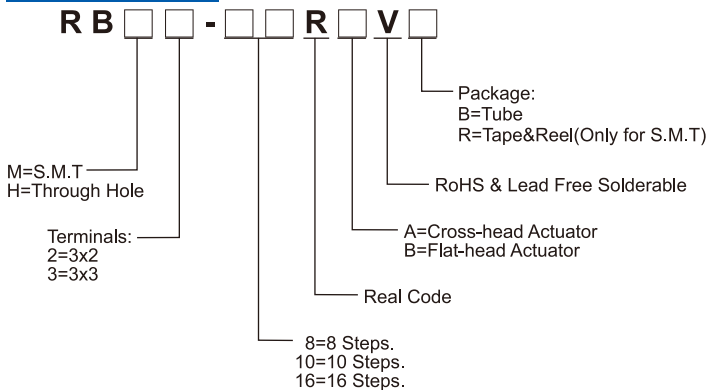

ROTARY CODED SWITCH

**RBH3-□□RA**

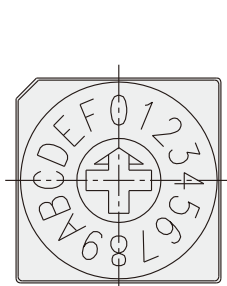

RBH3-16RA

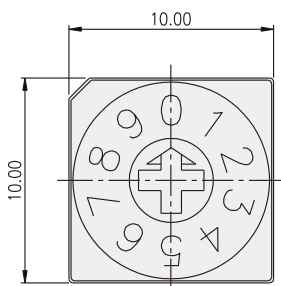

RBH3-10RA

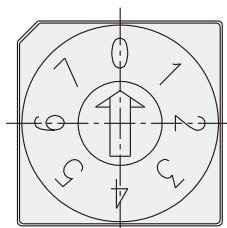
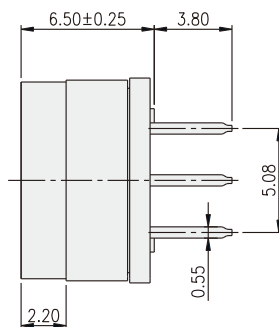

RBH3-8RB

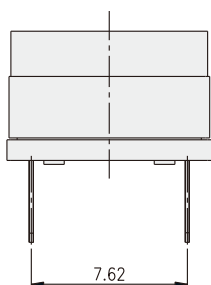

TYPE	POSITION	CODE			
		1	2	4	8
10R 08R	0	●	●	●	●
	1	○	●	●	●
	2	●	○	●	●
	3	○	○	●	●
	4	●	●	○	●
	5	○	●	○	●
	6	●	○	○	●
	7	○	○	○	●
	8	●	●	●	○
	9	○	○	●	○
16R	A	●	○	●	○
	B	○	○	●	○
	C	●	●	○	○
	D	○	●	○	○
	E	●	○	○	○
	F	○	○	○	○

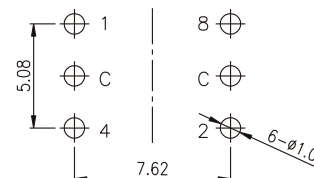

P.C.B. LAYOUT

**RBH2-□□RB**

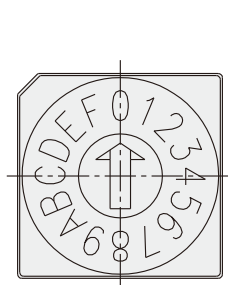

RBH2-16RB

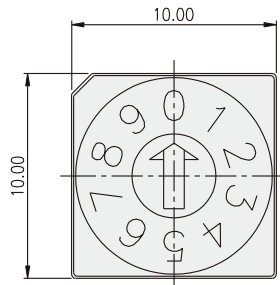

RBH2-10RB

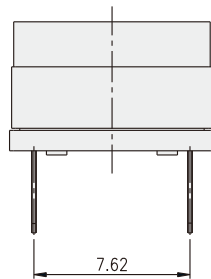
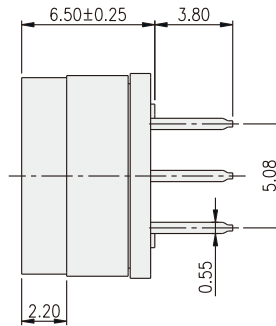

○ ON  
● OFF

TYPE	POSITION	CODE			
		1	2	4	8
10R	0	●	●	●	●
	1	○	○	●	●
	2	●	○	○	●
	3	○	○	●	●
	4	●	●	○	●
	5	○	○	○	●
	6	●	○	○	○
	7	○	○	○	●
	8	○	●	●	○
	9	●	●	●	○
16R	A	●	○	●	○
	B	○	○	●	○
	C	●	●	○	○
	D	○	●	○	○
	E	●	○	○	○
	F	○	○	○	○

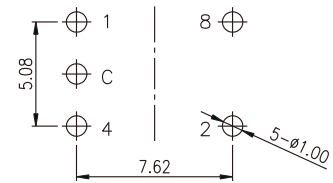

P.C.B. LAYOUT

**RBM3-□□RB**

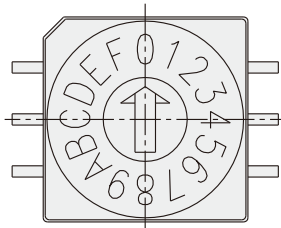

RBM3-16RB

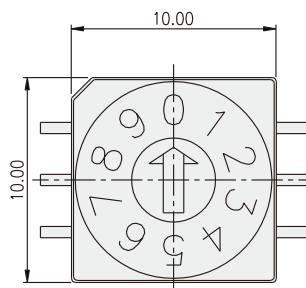

RBM3-10RB

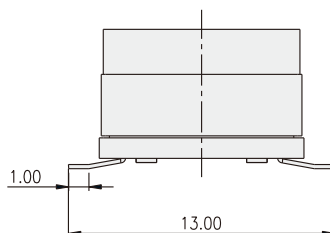
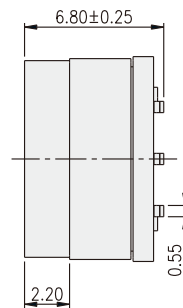

○ ON  
● OFF

TYPE	POSITION	CODE			
		1	2	4	8
10R	0	●	●	●	●
	1	○	●	●	●
	2	●	○	●	●
	3	○	○	●	●
	4	○	○	○	●
	5	○	●	○	●
	6	●	○	○	●
	7	○	○	○	○
	8	○	○	●	○
	9	○	●	●	○
16R	A	○	○	●	○
	B	○	○	●	○
	C	●	●	○	○
	D	○	●	○	○
	E	●	○	○	○
	F	○	○	○	○

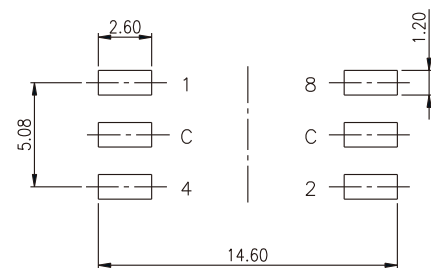

P.C.B. LAYOUT

ROTARY CODED SWITCH

单击下面可查看定价，库存，交付和生命周期等信息

[>>Diptronics\(圆达\)](#)