



SS32 THRU SS3200

Reverse Voltage - 20 to 200 Volts Forward Current - 3.0 Ampere

SURFACE MOUNT SCHOTTKY BARRIER RECTIFIER

Features

- ◆ The plastic package carries Underwriters Laboratory Flammability Classification 94V-0
- ◆ For surface mounted applications
- ◆ Metal silicon junction, majority carrier conduction
- ◆ Low power loss, high efficiency
- ◆ Built-in strain relief, ideal for automated placement
- ◆ High forward surge current capability
- ◆ High temperature soldering guaranteed: 250 °C/10 seconds at terminals

DO-214AC/SMA

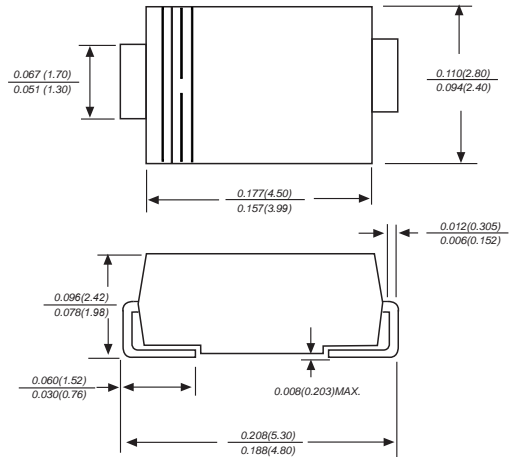

Dimensions in inches and (millimeters)

Mechanical Data

Case: JEDEC DO-214AC/SMA molded plastic body
 Terminals: Solderable per MIL-STD-750, Method 2026
 Polarity: Color band denotes cathode end Mounting
 Position: Any
 Weight: 0.0018 ounce, 0.064 grams

Maximum Ratings And Electrical Characteristics

Ratings at 25°C ambient temperature unless otherwise specified.

Single phase half-wave 60Hz, resistive or inductive load, for capacitive load current derate by 20%.

Parameter	SYMBOLS	SS32	SS33	SS34	SS35	SS36	SS38	SS310	SS3150	SS3200	UNITS
		MDD SS32	MDD SS33	MDD SS34	MDD SS35	MDD SS36	MDD SS38	MDD SS310	MDD SS3150	MDD SS3200	
Maximum repetitive peak reverse voltage	V _{RMM}	20	30	40	50	60	80	100	150	200	V
Maximum RMS voltage	V _{RMS}	14	21	28	35	42	56	70	105	140	V
Maximum DC blocking voltage	V _{DC}	20	30	40	50	60	80	100	150	200	V
Maximum average forward rectified current at TL (see fig. 1)	I <sub(av)< sub=""></sub(av)<>	3.0									A
Peak forward surge current 8.3ms single half sine-wave superimposed on rated load (JEDEC Method)	I _{FSM}	80									A
Maximum instantaneous forward voltage at 3.0A	V _F	0.55			0.70			0.85	0.95		V
Maximum DC reverse current T _A =25°C at rated DC blocking voltage T _A =125°C	I _R	0.5				0.3			3.0		mA
Typical junction capacitance (NOTE 1)	C _J	450				400					pF
Typical thermal resistance (NOTE 2)	R _{θJA}	70.0									°C/W
Operating junction temperature range	T _J	-55 to +125									°C
Storage temperature range	T _{STG}	-55 to +150									°C

Note: 1. Measured at 1.0MHz and applied reverse voltage of 4.0V D.C.
 2. P.C.B. mounted with 2.0x2.0" (5.0x5.0cm) copper pad areas.
 3. The typical data above is for reference only.



SS32G THRU SS3200G

Reverse Voltage - 20 to 200 Volts Forward Current - 3.0 Ampere

Typical Characteristics

Fig.1 Forward Current Derating Curve

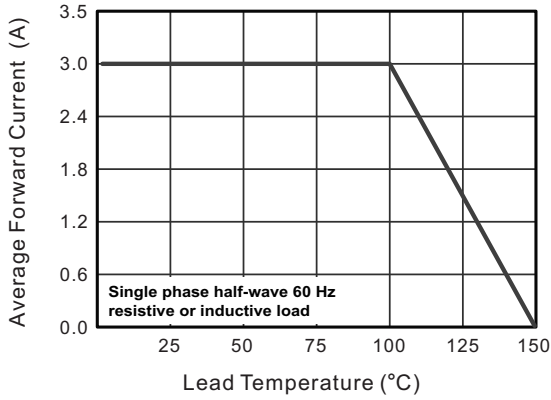

Fig.2 Typical Reverse Characteristics

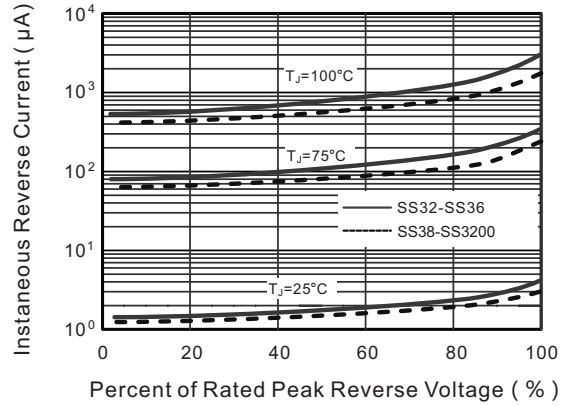

Fig.3 Typical Forward Characteristic

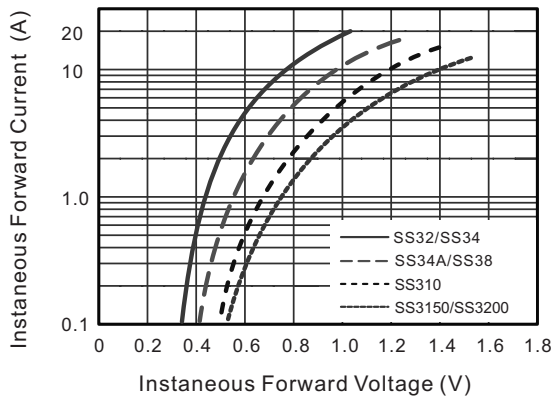

Fig.4 Typical Junction Capacitance

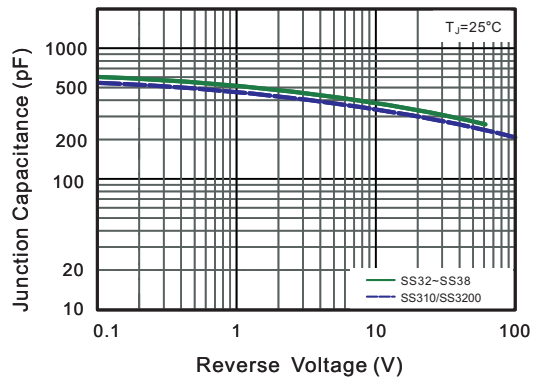

Fig.5 Maximum Non-Repetitive Peak Forward Surge Current

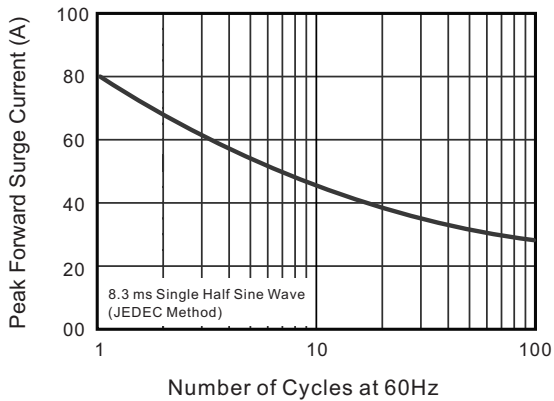
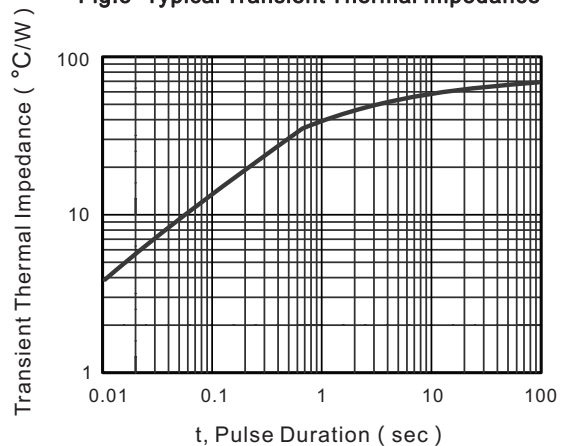

Fig.5- Typical Transient Thermal Impedance



The curve above is for reference only.



SS32G THRU SS3200G

Reverse Voltage - 20 to 200 Volts Forward Current - 3.0 Ampere

Packing information

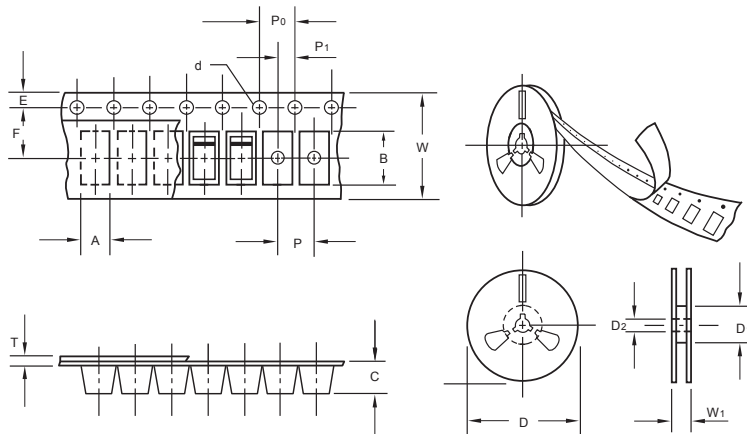

unit:mm

Item	Symbol	Tolerance	SMA
Carrier width	A	0.1	2.80
Carrier length	B	0.1	5.33
Carrier depth	C	0.1	2.36
Sprocket hole	d	0.05	1.50
13" Reel outside diameter	D	2.0	330.00
13" Reel inner diameter	D1	min	50.00
7" Reel outside diameter	D	2.0	178.00
7" Reel inner diameter	D1	min	62.00
Feed hole diameter	D2	0.5	13.00
Sprocket hole position	E	0.1	1.75
Punch hole position	F	0.1	5.50
Punch hole pitch	P	0.1	4.00
Sprocket hole pitch	P0	0.1	4.00
Embossment center	P1	0.1	2.00
Overall tape thickness	T	0.1	0.28
Tape width	W	0.3	12.00
Reel width	W1	1.0	18.00

Note: Devices are packed in accordance with EIA standard RS-481-A and specifications listed above.

Reel packing

PACKAGE	REEL SIZE	REEL (pcs)	COMPONENT SPACING (m/m)	BOX (pcs)	INNER BOX (m/m)	REEL DIA, (m/m)	CARTON SIZE (m/m)	CARTON (pcs)	APPROX. GROSS WEIGHT (kg)
SMA	7"	2,000	4.0	4,000	183*155*183	178	382*356*392	160,000	16.0
SMA	11"	5,000	4.0	10,000	290*290*38	330	310*310*360	80,000	11.0
SMA	13"	7,500	4.0	15,000	335*335*38	330	350*330*360	120,000	14.5

Suggested Pad Layout



Symbol	Unit (mm)	Unit (inch)
A	1.68	0.066
B	1.52	0.060
C	3.90	0.154
D	2.41	0.095
E	5.45	0.215

Important Notice and Disclaimer

Microdiode Electronics (Jiangsu) reserves the right to make changes to this document and its products and specifications at any time without notice. Customers should obtain and confirm the latest product information and specifications before final design, purchase or use.

Microdiode Electronics (Jiangsu) makes no warranty, representation or guarantee regarding the suitability of its products for any particular purpose, nor does Microdiode Electronics (Jiangsu) assume any liability for application assistance or customer product design. Microdiode Electronics (Jiangsu) does not warrant or accept any liability with products which are purchased or used for any unintended or unauthorized application.

No license is granted by implication or otherwise under any intellectual property rights of Microdiode Electronics (Jiangsu).

Microdiode Electronics (Jiangsu) products are not authorized for use as critical components in life support devices or systems without express written approval of Microdiode Electronics (Jiangsu).

单击下面可查看定价，库存，交付和生命周期等信息

[>>MDD\(辰达行\)](#)