

RECOMMENDED PC BOARD  
PATTERN DIM.(REF.)

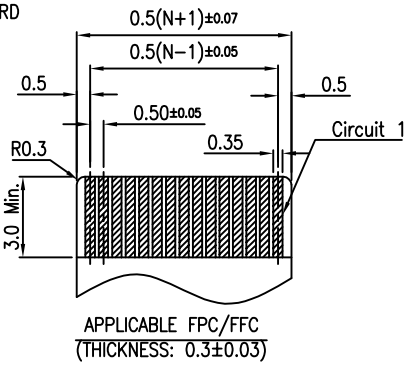

APPLICABLE FPC/FFC  
(THICKNESS: 0.3±0.03)

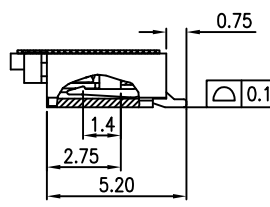
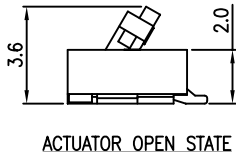

ACTUATOR OPEN STATE

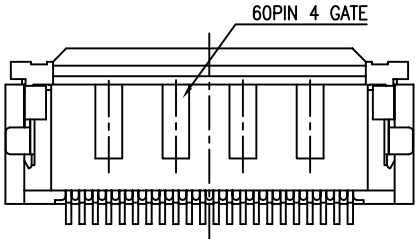
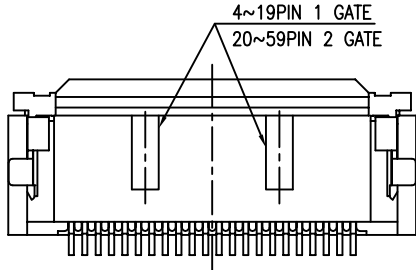
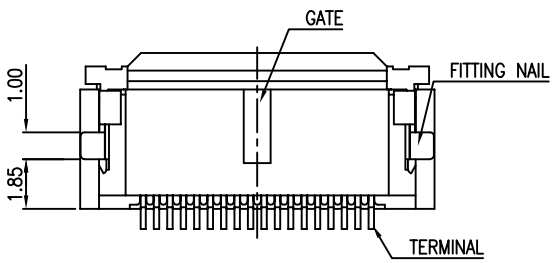
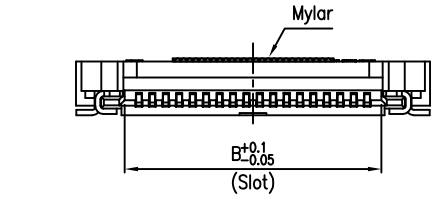

- NOTES:
- MATERIAL:
    - HOUSING: THERMOPLASTIC, HIGH TEMP.,UL94V-0;
    - CONTACT: COPPER ALLOY
    - FITTING NAIL:COPPER ALLOY
    - LATCH: THERMOPLASTIC, HIGH TEMP.,UL94V-0;
  - FINISH:
    - CONTACT:
      - 50u" MIN. NICKEL UNDER PLATING
      - GOLD FLASH ON PLATING AREA
      - 15u" GOLD FLASH ON PLATING AREA
      - 80~120u" MATTE TIN PLATING
      - 5u" GOLD PLATING ON CONTACT AREA AND GOLD FLASH PLATING ON SOLDER AREA
    - FITTING NAIL:
      - 50u" MIN. NICKEL UNDER PLATING
      - 100~200u" MATTE TIN PLATING
  - REFLOW SOLDER CAPABLE TO 260°C PER ACES SPEC.
  - SPEC. PLS. REFER TO PS-51619-XXXX-XXX
  - PACKAGE PLS. REFER TO 88241-XXXX-XX-TRP
  - PART NUMBER  
51619-XXX X X-XXX

NO OF CKT	XXX	HOUSING COLOR	ACTUATOR COLOR	LOGO
001	002	BLACK	NATURAL	WITH
		NATURAL	BLACK	WITH

PACKING:  
 0: TAPE & REEL  
 1: TUBE  
 4: TAPE & REEL WITH MYLAR

PLATING:  
 1: GOLD FLASH (LEAD FREE)  
 C: 15u" GOLD ON CONTACT  
 N: MATTE TIN (LEAD FREE)  
 B: 5u" GOLD PLATING ON CONTACT

CK 1	Dim A	Dim B	Dim C	Dim W	CK 1	Dim A	Dim B	Dim C	M/(S/W)
4	1.50	2.56	6.2	5.2	33	16.00	17.06	20.7	10.0
5	2.00	3.06	6.7	5.2	34	16.50	17.56	21.2	10.0
6	2.50	3.56	7.2	5.2	35	17.00	18.06	21.7	10.0
7	3.00	4.06	7.7	5.2	36	17.50	18.56	22.2	10.0
8	3.50	4.56	8.2	5.2	37	18.00	19.06	22.7	10.0
9	4.00	5.06	8.7	5.2	38	18.50	19.56	23.2	10.0
10	4.50	5.56	9.2	5.2	39	19.00	20.06	23.7	10.0
11	5.00	6.06	9.7	5.2	40	19.50	20.56	24.2	10.0
12	5.50	6.56	10.2	6.0	41	20.00	21.06	24.7	10.0
13	6.00	7.06	10.7	6.0	42	20.50	21.56	25.2	10.0
14	6.50	7.56	11.2	6.0	43	21.00	22.06	25.7	10.0
15	7.00	8.06	11.7	6.0	44	21.50	22.56	26.2	10.0
16	7.50	8.56	12.2	6.0	45	22.00	23.06	26.7	15.0
17	8.00	9.06	12.7	6.0	46	22.50	23.56	27.2	15.0
18	8.50	9.56	13.2	6.0	47	23.00	24.06	27.7	15.0
19	9.00	10.06	13.7	6.0	48	23.50	24.56	28.2	15.0
20	9.50	10.56	14.2	6.0	49	24.00	25.06	28.7	15.0
21	10.00	11.06	14.7	6.0	50	24.50	25.56	29.2	15.0
22	10.50	11.56	15.2	6.0	51	25.00	26.06	29.7	15.0
23	11.00	12.06	15.7	6.0	52	25.50	26.56	30.2	15.0
24	11.50	12.56	16.2	6.0	53	26.00	27.06	30.7	15.0
25	12.00	13.06	16.7	6.0	54	26.50	27.56	31.2	15.0
26	12.50	13.56	17.2	6.0	55	27.00	28.06	31.7	15.0
27	13.00	14.06	17.7	6.0	56	27.50	28.56	32.2	15.0
28	13.50	14.56	18.2	6.0	57	28.00	29.06	32.7	15.0
29	14.00	15.06	18.7	6.0	58	28.50	29.56	33.2	15.0
30	14.50	15.56	19.2	6.0	59	29.00	30.06	33.7	15.0
31	15.00	16.06	19.7	6.0	60	29.50	30.56	34.2	15.0
32	15.50	16.56	20.2	6.0	61	30.00	31.06	34.7	15.0

QUALITY SYMBOLS MAJOR (M) CRITICAL (C)	DRAWN BY Sun,Ya Jie DATE 20/04/17	
GENERAL TOLERANCES (UNLESS SPECIFIED) X. ±0.5 .X ±0.25 .XX ±0.15 .XXX ±0.1 ANGLES ±2°	CHECKED BY Xu,Zhi Yong DATE 20/04/17	
	APPROVED BY Xu,Zhi Yong DATE 20/04/17	TITLE 0.5 mm PITCH EASY ON FPC/FFC CONN. SMT R/A/B/C TYPE
UNITS mm	SIZE A4	REQ. NO. X
SCALE 4:1	SHEET NO. 1 OF 2	REV N
		PART NO. SEE NOTES
		DWG. NO. 51619-XXXX-XXX

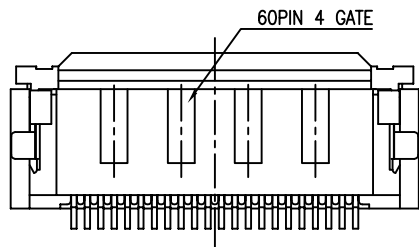
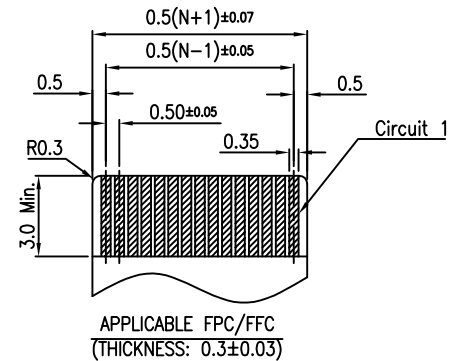
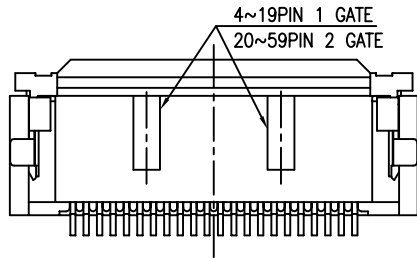
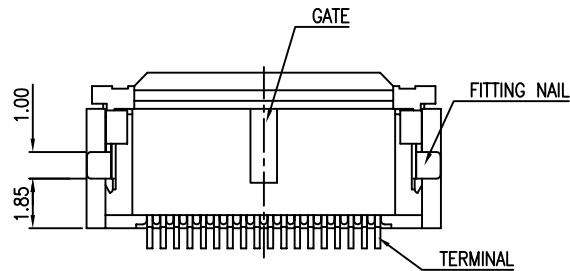
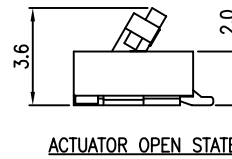
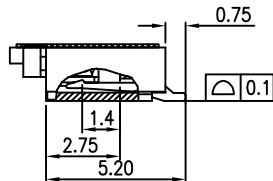
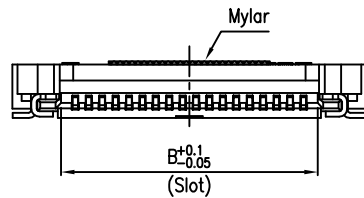
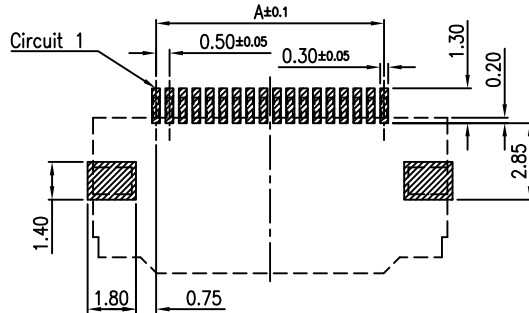
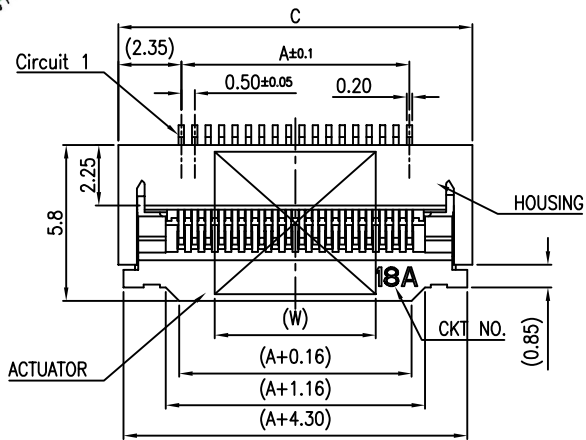

CKT	Dim A	Dim B	Dim C	Dim W
18	8.50	9.56	13.2	6.0

- NOTES:
- MATERIAL:
    - HOUSING: THERMOPLASTIC, HIGH TEMP.,UL94V-0;
    - CONTACT: COPPER ALLOY
    - FITTING NAIL: COPPER ALLOY
    - LATCH: THERMOPLASTIC, HIGH TEMP.,UL94V-0;
  - FINISH:
    - CONTACT:
      - 50u" MIN. NICKEL UNDER PLATING
      - 1: GOLD FLASH ON PLATING AREA
      - C: 15u" GOLD FLASH ON PLATING AREA
      - N: 80~120u" MATTE TIN PLATING
      - B: 5u" GOLD PLATING ON CONTACT AREA AND GOLD FLASH PLATING ON SOLDER AREA
    - FITTING NAIL:
      - 50u" MIN. NICKEL UNDER PLATING
      - 100~200u" MATTE TIN PLATING
  - REFLOW SOLDER CAPABLE TO 260°C PER ACES SPEC.
  - SPEC. PLS. REFER TO PS-51619-XXXX-XXX
  - PACKAGE PLS. REFER TO 88241-XXXX-XX-TRP
  - PART NUMBER  
51619-XXX X X-XXX

NO OF CKT	XXX	HOUSING COLOR	ACTUATOR COLOR	LOGO
003		BLACK	NATURAL	WITHOUT

- PACKING
- TAPE & REEL
  - TUBE
  - TAPE & REEL WITH MYLAR
- PLATING
- GOLD FLASH (LEAD FREE)
  - 15u" GOLD ON CONTACT
  - MATTE TIN (LEAD FREE)
  - 5u" GOLD PLATING ON CONTACT

QUALITY SYMBOLS	DRAWN BY	DATE		
MAJOR Ⓜ	Sun,Ya Jie	20/04/17		
CRITICAL Ⓢ	CHECKED BY	DATE	<b>Acas ELECTRONICS</b> TITLE 0.5 mm PITCH EASY ON FPC/FFC CONN. SMT R/A/B/C TYPE	
GENERAL TOLERANCES ( UNLESS SPECIFIED )	Xu,Zhi Yong	20/04/17		
X. ±0.5	APPROVED BY	DATE	UNITS	SIZE
.X ±0.25	Xu,Zhi Yong	20/04/17	mm	A4
.XX ±0.15			SCALE	SHEET NO.
.XXX ±0.1			4 : 1	2 OF 2
ANGLES ±2°			REV	N
			RFQ NO.	X
			PART NO.	SEE NOTES
			DWG NO.	51619-XXXXX-XXX

单击下面可查看定价，库存，交付和生命周期等信息

[>>ACES\(宏致\)](#)