

**PRODUCT
DATASHEET**



CLM3820 45A Series Device

CLM3820 45A Series Device

Description

Current Limiting Module (CLM) is a chip type surface mountable device that can protect against both overcurrent and overcharging. It comprises a fuse element to ensure stable operation under normal electrical current and to cut off the current when overcurrent occurs. It also comprises a resistive heating element that could be used in combination with a voltage detecting means, such as IC and FET. When overvoltage is detected, the heating element is electrically excited to generate heat to blow the fuse element to achieve overvoltage protection.



Features

- Halogen-free
- Surface mountable
- Overcharging protection
- Fast response time
- Overcurrent protection

Application



- Self Balancing
- Automotive applications
- E-Bike
- Energy Storage systems
- Power Tool
- Drone

Agency Approval and Environmental Compliance

Agency	File Number	Regulation	Standard
	E331807		IEC 61249-2-21:2003
	TA 50428400		

RoHS Directive: Compliance (this product complies with RoHS exemption requirements)

Electrical Specifications

Part Number	I _{rated} (A)	Cells in series	V _{max} (V _{dc})	I _{break} (A)	V _{OP} (V)	Resistance		Agency Approval	
						R _{heater} (Ω)	R _{fuse} (mΩ)		
CLM3820P1245	45	3	62	120	9.8 ~ 13.5	1.9 ~ 3.4	0.4 ~ 2.0	✓	✓
CLM3820P1445	45	4	62	120	13.0 ~ 18.4	3.4 ~ 6.0	0.4 ~ 2.0	✓	✓
CLM3820P2045	45	5	62	120	16.7 ~ 23.5	5.6 ~ 9.9	0.4 ~ 2.0	✓	✓
CLM3820P3045	45	6~7	62	120	22.3 ~ 31.5	10.0 ~ 17.7	0.4 ~ 2.0	✓	✓
CLM3820P4045	45	9~10	62	120	33.0 ~ 46.9	22.0 ~ 38.7	0.4 ~ 2.0	✓	✓
CLM3820P5045	45	12~14	62	120	43.7 ~ 62.0	38.5 ~ 68.0	0.4 ~ 2.0	✓	✓

CLM3820 45A Series Device

Electrical Characteristics

Current Capacity	100% x I_{rated} No Melting
Cut Time	200% x I_{rated} < 1 min
Interrupting Current	150A, power on 5 ms, power off 995 ms, 10000 cycles No Melting
Over Voltage Operation	In operation voltage range, the fusing time is <1min.

Note on Electrical Specifications & Characteristics

■ Vocabulary

- I_{rated} = Current carrying capacity that is measured at 40°C thermal equilibrium condition.
 I_{break} = The current that the fuse element is able to interrupt.
 V_{max} = The maximum voltage that can be cut off by fuse.
 V_{op} = Range of operation voltage.
 R_{heater} = The resistance of the heating element.
 R_{fuse} = The resistance of the fuse element.

Cells in series = Number of battery cells connected in series in the circuit for CLM device to protect.

- Value specified is determined by using the PWB with 25mm*2oz copper traces, AWG8 covered wire, and 0.6mm glass epoxy PCB.
- Specifications are subject to change without notice.

⚠ WARNING

■ General

- Before and after mounted, the ultrasonic-cleaning or immersion-cleaning must not be done to CLM device. The flux on element would flow, and it would not be satisfied its specification when cleaning is done. In addition, a similar influence happens when the product comes in contact with cleaning-solution. These products after cleaning will not be guaranteed.
- Silicone-based oils, oils, solvents, gels, electrolytes, fuels, acids, and the like will adversely affect the properties of CLM devices, and shall not be used or applied.
- Please Do Not reuse the CLM device removed by the soldering process.
- CLM devices are secondary protection devices and are used solely for sporadic, accidental over-current or over-temperature error condition, and shall NOT be used if or when constant or repeated fault conditions (such fault conditions may be caused by, among others, incorrect pin-connection of a connector) or over-extensive trip events may occur.
- Operation over the maximum rating or other forms of improper use may cause failure, arcing, flame and/or other damage to the CLM devices.
- The performance of CLM devices will be adversely affected if they are improperly used under electronic, thermal and/or mechanical procedures and/or conditions non-conformant to those recommended by manufacturer.
- Customers shall be responsible for determining whether it is necessary to have back-up, failsafe and/or fool-proof protection to avoid or minimize damage that may result from extra-ordinary, irregular function or failure of CLM devices.
- There should be minimum of 0.1mm spacing between CLM and surrounding compounds, to maintain the product characteristics and avoid damage other surrounding compounds.
- This product is designed and manufactured only for general-use of electronics devices. We do not recommend that it is used for the applications Military, Medical and so on which may cause direct damages on life, bodies or properties.

CLM3820 45A Series Device

Thermal Derating Characteristics

Ambient Temperature (°C)	25	40	60
Recommend Rated Current (A)	49.0	44.5	37.0

Cut Time by Heater Operation

■ Various heater wattage at 25°C ambient temperature.

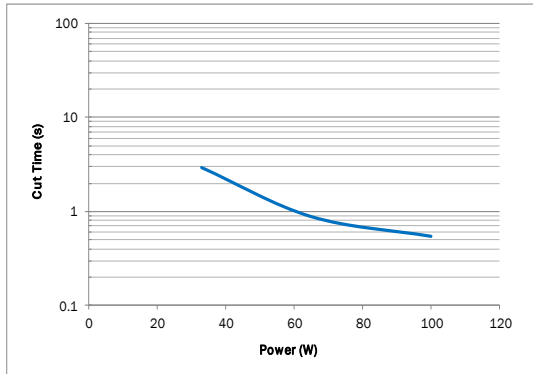

■ Constant heater wattage at various ambient temperature.

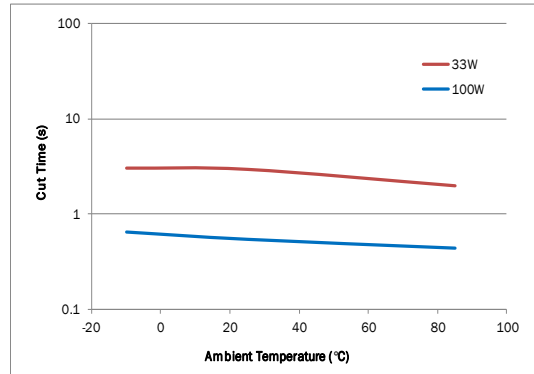

Cut Time by Current Operation

■ Various interrupting current at 25°C ambient temperature.

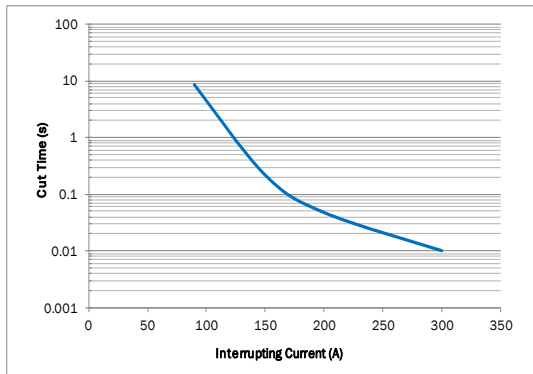

■ Constant 2x rated current at various ambient temperature.

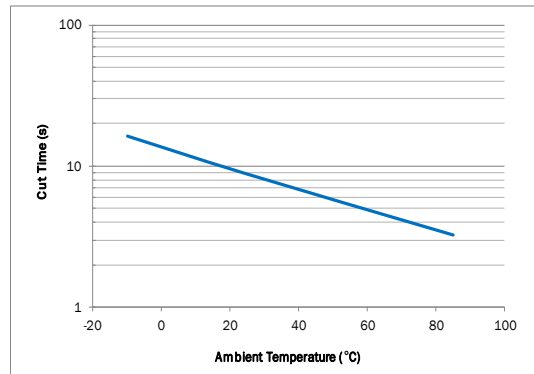

CLM3820 45A Series Device

Device Circuit

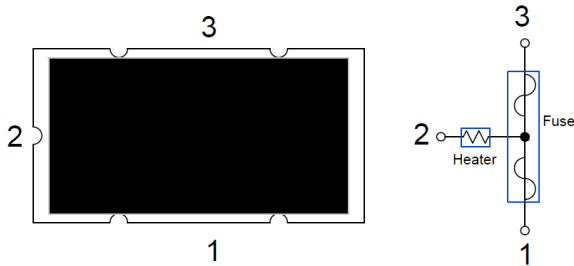

Physical Dimensions (mm.)

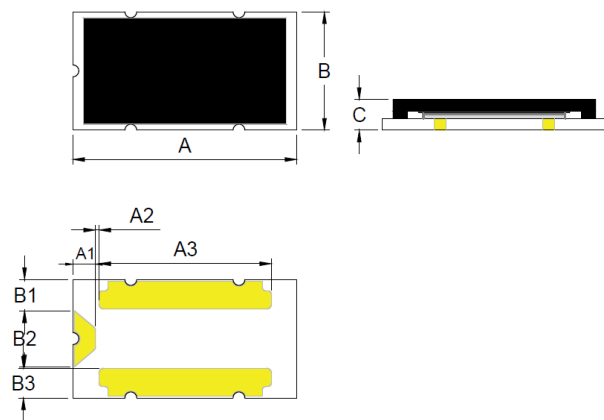

A	9.50 ± 0.2
B	5.00 ± 0.3
C	2.00 max
A1	0.89 ± 0.1
A2	0.15 ± 0.1
A3	7.32 ± 0.1

B1	1.32 ± 0.1
B2	2.36 ± 0.1
B3	1.25 ± 0.1

Environmental Specifications

Storage Temperature	0~35°C, ≤70%RH 3 months after shipment
Operating Temperature	-10°C to +65 °C
Hot Passive Aging	100±5°C, 250 hours No structural damage and functional failure
Humidity Aging	60°C±2°C, 90~95%R.H. 250 hours No structural damage and functional failure
Cold Passive Aging	-20±3°C, 500 hours No structural damage and functional failure
Thermal Shock	MIL-STD-202 Method 107G +125°C /-55°C, 100 times No structural damage and functional failure

Board and Solder Layout Recommend (mm)

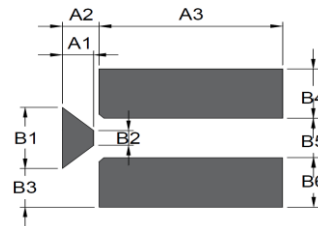

Material	Glass Epoxy PCB
Base Thickness	0.6mm
Copper Thickness	0.07mm
Covered Wire	AWG8

A1	1.30 ± 0.1
A2	1.52 ± 0.1
A3	7.60 ± 0.1

B1	3.10 ± 0.1
B2	0.75 ± 0.1
B3	1.95 ± 0.1
B4	2.50 ± 0.1
B5	2.00 ± 0.1
B6	2.50 ± 0.1

Part Number System

CLM 3820 P 12 45

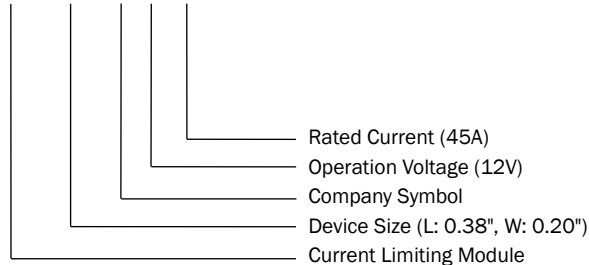

Part Marking System

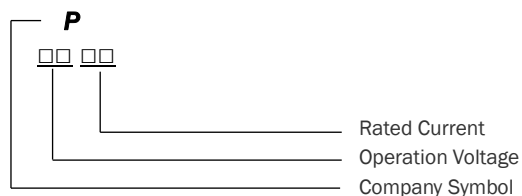

CLM3820 45A Series Device

Soldering Parameters

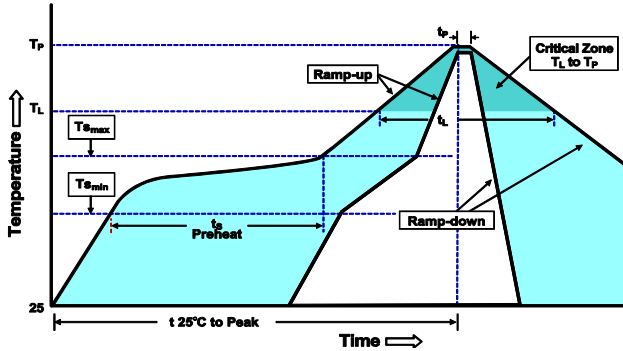

Average Ramp-Up Rate (T _{smax} to T _P)	3°C/second max.
Preheat	
-Temperature Min (T _{smin})	150°C
-Temperature Max (T _{smax})	200°C
-Time (T _{smin} to T _{smax})	60-120 seconds
Time maintained above:	
-Temperature (T _L)	217°C
-Time (t _L)	60-105 seconds
Peak Temperature (T _P)	255°C
Time within 5°C of actual Peak	
Temperature (t _P)	5 seconds max.
Ramp-Down Rate	6°C /second max.
Time 25°C to Peak Temperature	8 minutes max.

Note 1: The temperature shown above is the top-side surface temperature of the device.
Note 2: If the soldering temperature profile deviates from the recommended profile, devices may not meet the performance requirements

Tape & Reel Specification (mm.)

Devices are packaged per EIA481 and EIA-2 standard

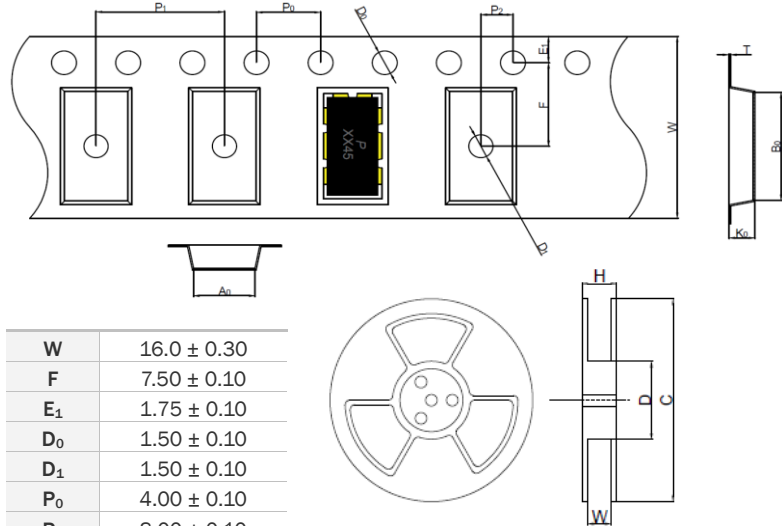

W	16.0 ± 0.30
F	7.50 ± 0.10
E ₁	1.75 ± 0.10
D ₀	1.50 ± 0.10
D ₁	1.50 ± 0.10
P ₀	4.00 ± 0.10
P ₁	8.00 ± 0.10
P ₂	2.00 ± 0.10
A ₀	5.40 ± 0.10
B ₀	9.85 ± 0.10
T	0.30 ± 0.05
K ₀	2.48 ± 0.10

H	21.4 ± 1.0
W	17.4 ± 1.0
D	Ø99.0 ± 0.5
C	Ø330 ± 1.0

Packaging Quantity

Part Number	Tape & Reel Quantity
CLM3820PXX45	1000

单击下面可查看定价，库存，交付和生命周期等信息

>> [聚鼎](#)