



RLD 16V GMF Series PTC Devices

RLD 16V GMF Series PTC Devices

Description

The GMF series provides radial leaded resettable over-current protection with holding current from 2.5A to 20.0A. This series is suitable for wide range of applications in modern electronics and automotive industry.

Features





- RoHS compliant and lead-free
- Halogen-free
- Compact design saves board space
- Low profile
- Fast response to fault current





Applications

- Computer & peripherals
- USB hubs, ports and peripherals
- General electronics
- Medical equipments
- Transformers
- Motors

Agency Approval and Environmental Compliance



| Agency | File Number | Regulation | Standard |
|---|-------------|---|---------------------|
|  | E201431 |  | 2011/65/EU |
|  | R50103284 |  | IEC 61249-2-21:2003 |

Electrical Characteristics

| Part Number | I _{hold} (A) | I _{trip} (A) | V _{max} (Vdc) | I _{max} (A) | P _{d typ} (W) | Maximum Time To Trip | | Resistance | | Agency Approval | |
|---------------|-----------------------|-----------------------|------------------------|----------------------|------------------------|----------------------|-------------|----------------------|-----------------------|---|---|
| | | | | | | Current (A) | Time (Sec.) | R _{min} (Ω) | R _{1max} (Ω) |  |  |
| RLD16P250GMF | 2.5 | 5.0 | 16 | 100 | 0.5 | 12.5 | 1.4 | 0.0180 | 0.0950 | ✓ | ✓ |
| RLD16P300GMF | 3.0 | 6.0 | 16 | 100 | 0.7 | 15.0 | 1.5 | 0.0170 | 0.0900 | ✓ | ✓ |
| RLD16P400GMF | 4.0 | 8.0 | 16 | 100 | 0.8 | 20.0 | 1.8 | 0.0090 | 0.0510 | ✓ | ✓ |
| RLD16P500GMF | 5.0 | 10.0 | 16 | 100 | 1.0 | 25.0 | 2.3 | 0.0040 | 0.0180 | ✓ | ✓ |
| RLD16P600GMF | 6.0 | 11.5 | 16 | 100 | 1.1 | 30.0 | 3.3 | 0.0030 | 0.0150 | ✓ | ✓ |
| RLD16P700GMF | 7.0 | 13.0 | 16 | 100 | 1.2 | 35.0 | 3.5 | 0.0026 | 0.0130 | ✓ | ✓ |
| RLD16P800GMF | 8.0 | 14.0 | 16 | 100 | 1.3 | 40.0 | 5.0 | 0.0025 | 0.0100 | ✓ | ✓ |
| RLD16P900GMF | 9.0 | 16.0 | 16 | 100 | 1.4 | 45.0 | 5.5 | 0.0023 | 0.0080 | ✓ | ✓ |
| RLD16P1000GMF | 10.0 | 17.0 | 16 | 100 | 1.6 | 50.0 | 6.0 | 0.0022 | 0.0065 | ✓ | ✓ |
| RLD16P1100GMF | 11.0 | 18.0 | 16 | 100 | 1.8 | 55.0 | 7.0 | 0.0020 | 0.0055 | ✓ | ✓ |
| RLD16P1200GMF | 12.0 | 19.5 | 16 | 100 | 2.0 | 60.0 | 7.5 | 0.0014 | 0.0045 | ✓ | ✓ |
| RLD16P1400GMF | 14.0 | 21.0 | 16 | 100 | 2.2 | 70.0 | 9.0 | 0.0012 | 0.0035 | ✓ | ✓ |
| RLD16P1500GMF | 15.0 | 24.0 | 16 | 100 | 2.4 | 75.0 | 10.0 | 0.0009 | 0.0030 | ✓ | ✓ |

RLD 16V GMF Series PTC Devices

(Continued)

| Part Number | I _{hold} (A) | I _{trip} (A) | V _{max} (Vdc) | I _{max} (A) | P _{d typ} (W) | Maximum Time To Trip | | Resistance | | Agency Approval | |
|---------------|--------------------------|--------------------------|---------------------------|-------------------------|---------------------------|----------------------|----------------|-------------------------|--------------------------|---|---|
| | | | | | | Current (A) | Time (Sec.) | R _{min} (Ω) | R _{1max} (Ω) |  |  |
| RLD16P1750GMF | 17.5 | 27.5 | 16 | 100 | 2.8 | 87.5 | 11.0 | 0.0006 | 0.0025 | ✓ | ✓ |
| RLD16P2000GMF | 20.0 | 30.0 | 16 | 100 | 3.0 | 100.0 | 12.0 | 0.0005 | 0.0020 | ✓ | ✓ |

Note on Electrical Characteristics

■ **Vocabulary**

I_{hold} = Hold current: maximum current device will pass without tripping in 23°C still air.

I_{trip} = Trip current: minimum current at which the device will trip in 23 °C still air.

V_{max} = Maximum voltage device can withstand without damage at rated current (I_{max})

I_{max} = Maximum fault current device can withstand without damage at rated voltage (V_{max})

P_{d typ} = Typical power dissipated from device when in the tripped state at 23 °C still air.

R_{min} = Minimum resistance of device in initial (un-soldered) state.

R_{1max} = Maximum resistance of device at 23 °C measured one hour after tripping or reflow soldering of 260 °C for 20 sec.

■ **Caution: Operation beyond the specified rating may result in damage and possible arcing and flame.**

■ **Specifications are subject to change without notice.**

RLD 16V GMF Series PTC Devices

Polymeric PTC Selecting Guide

■ Determine the following operating parameters for the circuits:

- Normal operating current (I_{hold})
- Maximum interrupt current (I_{max})
- Maximum circuit voltage (V_{max})
- Normal operating temperature surrounding device (min°C/max°C)

■ Select the device form factor and dimension suitable for the application:

- Surface Mount Device (SMD)
- Axial Leaded Device (ALD)
- Other Customized Form Factors
- Radial Leaded Device (RLD)
- DISC Device

■ Compare the maximum rating for V_{max} and I_{max} of the PPTC device with the circuit in application and make sure the circuit's requirement does not exceed the device rating.

■ Check that PPTC device's trip time (time-to-trip) will protect the circuit.

■ Verify that the circuit operating temperature is within the PPTC device's normal operating temperature range.

■ Verify the performance and suitability of the chosen PPTC device in the application.

WARNING

■ **Mechanical Stress**

- PPTC devices will undergo a thermal expansion during fault condition. If PPTC devices are installed or placed in an application where the space between PPTC devices and the surrounding materials (e.g., covering materials, packaging materials, encapsulate materials and the like) is insufficient, it will cause an inhibiting effect upon the thermal expansion. Pressing, twisting, bending and other kinds of mechanical stress will also adversely affect the performance of the PPTC devices, and shall not be used or applied.

■ **Chemical Pollutants**

- Silicone-based oils, oils, solvents, gels, electrolytes, fuels, acids, and the like will adversely affect the properties of PPTC devices, and shall not be used or applied.

■ **Electronic and Thermal Effect**

- PPTC devices are secondary protection devices and are used solely for sporadic, accidental over-current or over-temperature error condition, and shall NOT be used if or when constant or repeated fault conditions (such fault conditions may be caused by, among others, incorrect pin-connection of a connector) or over-extensive trip events may occur.
- PPTC devices are different from fuses and, when a fault condition occurs, will go into high-resistance state and do not open circuit, in which case the voltage at such PPTC devices may reach a hazardous level.
- Operation over the maximum rating or other forms of improper use may cause failure, arcing, flame and/or other damage to the PPTC devices.
- Conductive material contamination, such as metal particle, may induce shortage, flame or arcing.
- Due to the inductance, the operation circuits may generate a circuit voltage (Ldi/dt) above the rated voltage of PPTC devices, which shall not be used under such circumstances.

■ **General**

- Customers shall evaluate and test the properties of PPTC devices independently to verify and ensure that their individual applications will be met.
- The performance of PPTC devices will be adversely affected if they are improperly used under electronic, thermal and/or mechanical procedures and/or conditions non-conformant to those recommended by manufacturer.
- Customers shall be responsible for determining whether it is necessary to have back-up, failsafe and/or fool-proof protection to avoid or minimize damage that may result from extra-ordinary, irregular function or failure of PPTC devices.
- Any and all responsibilities and liabilities are disclaimed if any item under this notice of warning is not complied with.

RLD 16V GMF Series PTC Devices

Average Time-to-Trip Curves

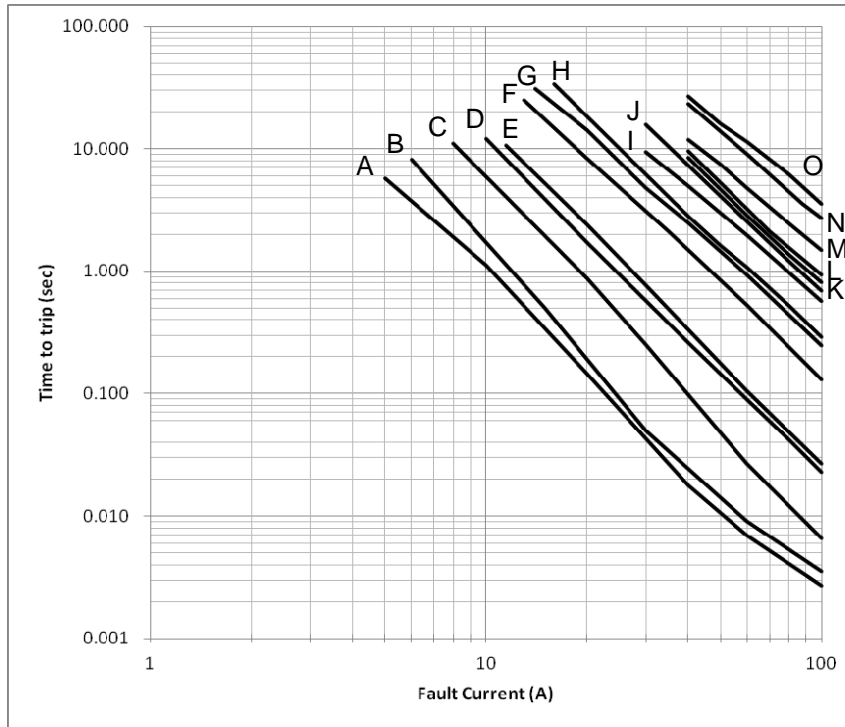

- A = RLD16P250GMF
- B = RLD16P300GMF
- C = RLD16P400GMF
- D = RLD16P500GMF
- E = RLD16P600GMF
- F = RLD16P700GMF
- G = RLD16P800GMF
- H = RLD16P900GMF
- I = RLD16P1000GMF
- J = RLD16P1100GMF
- K = RLD16P1200GMF
- L = RLD16P1400GMF
- M = RLD16P1500GMF
- N = RLD16P1750GMF
- O = RLD16P2000GMF

RLD 16V GMF Series PTC Devices

Thermal Derating Curve

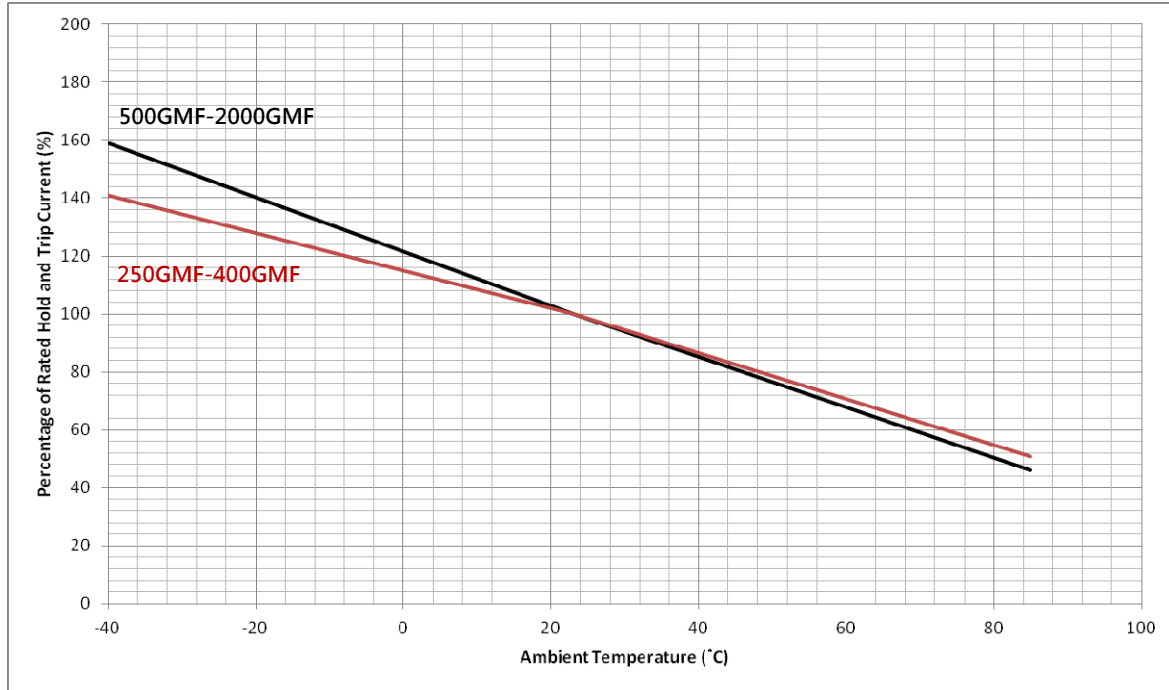

Thermal Derating Table

Recommended Hold Current (A) vs. Ambient Temperature (°C)

| Part Number | Ambient Operation Temperature | | | | | | | | |
|---------------|-------------------------------|--------|------|-------|-------|-------|-------|-------|-------|
| | -40 °C | -20 °C | 0 °C | 23 °C | 40 °C | 50 °C | 60 °C | 70 °C | 85 °C |
| RLD16P250GMF | 3.5 | 3.2 | 2.9 | 2.5 | 2.2 | 2.0 | 1.8 | 1.6 | 1.3 |
| RLD16P300GMF | 4.2 | 3.8 | 3.4 | 3.0 | 2.6 | 2.4 | 2.1 | 1.9 | 1.5 |
| RLD16P400GMF | 5.6 | 5.1 | 4.6 | 4.0 | 3.5 | 3.1 | 2.8 | 2.5 | 2.0 |
| RLD16P500GMF | 8.0 | 7.0 | 6.1 | 5.0 | 4.3 | 3.8 | 3.4 | 3.0 | 2.3 |
| RLD16P600GMF | 9.5 | 8.4 | 7.3 | 6.0 | 5.1 | 4.6 | 4.1 | 3.5 | 2.8 |
| RLD16P700GMF | 11.1 | 9.8 | 8.5 | 7.0 | 6.0 | 5.4 | 4.7 | 4.1 | 3.2 |
| RLD16P800GMF | 12.7 | 11.2 | 9.7 | 8.0 | 6.8 | 6.1 | 5.4 | 4.7 | 3.7 |
| RLD16P900GMF | 14.3 | 12.6 | 10.9 | 9.0 | 7.7 | 6.9 | 6.1 | 5.3 | 4.1 |
| RLD16P1000GMF | 15.9 | 14.0 | 12.2 | 10.0 | 8.5 | 7.6 | 6.8 | 5.9 | 4.6 |
| RLD16P1100GMF | 17.5 | 15.4 | 13.4 | 11.0 | 9.4 | 8.4 | 7.5 | 6.5 | 5.1 |
| RLD16P1200GMF | 19.1 | 16.8 | 14.6 | 12.0 | 10.2 | 9.2 | 8.1 | 7.1 | 5.5 |
| RLD16P1400GMF | 22.3 | 19.6 | 17.0 | 14.0 | 11.9 | 10.7 | 9.5 | 8.3 | 6.4 |
| RLD16P1500GMF | 23.9 | 21.0 | 18.2 | 15.0 | 12.8 | 11.5 | 10.2 | 8.9 | 6.9 |
| RLD16P1750GMF | 27.8 | 24.5 | 21.3 | 17.5 | 14.9 | 13.4 | 11.9 | 10.3 | 8.1 |
| RLD16P2000GMF | 31.8 | 28.1 | 24.3 | 20.0 | 17.0 | 15.3 | 13.6 | 11.8 | 9.2 |

RLD 16V GMF Series PTC Devices

Physical Dimensions (mm.)

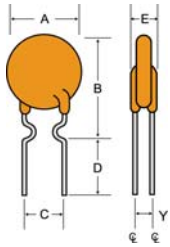

Fig. 1

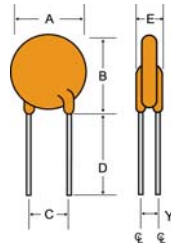

Fig. 2

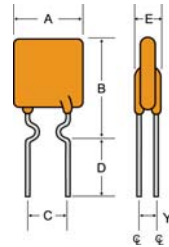

Fig. 3

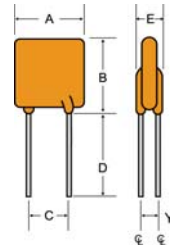

Fig. 4

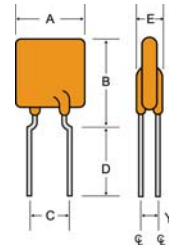
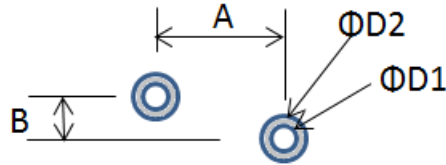

Fig. 5

| Part Number | A Max. | B Max. | C Typ. | D Min. | E Max. | Y | Fig. | Lead Dia. |
|-----------------|-----------|-----------|-----------|-----------|-----------|------|------|-----------|
| | | | | | | Typ. | | |
| RLD16P250GMF | 7.6 | 12.2 | 5.1±0.7 | 7.6 | 2.8 | 0.8 | 3 | 0.51 |
| RLD16P250GMF-S | 7.6 | 9.8 | 5.1±0.7 | 7.6 | 2.8 | 0.8 | 4 | 0.51 |
| RLD16P300GMF | 8.0 | 9.4 | 5.1±0.7 | 7.6 | 3.2 | 1.1 | 4 | 0.81 |
| RLD16P300GMF-K | 8.0 | 12.4 | 5.1±0.7 | 7.6 | 3.2 | 1.1 | 3 | 0.81 |
| RLD16P400GMF | 8.9 | 11.9 | 5.1±0.7 | 7.6 | 3.2 | 1.1 | 4 | 0.81 |
| RLD16P400GMF-K | 8.9 | 16.4 | 5.1±0.7 | 7.6 | 3.2 | 1.1 | 3 | 0.81 |
| RLD16P500GMF | 7.6 | 12.2 | 5.1±0.7 | 7.6 | 3.2 | 1.3 | 5 | 0.81 |
| RLD16P600GMF | 8.0 | 14.2 | 5.1±0.7 | 7.6 | 3.2 | 1.3 | 5 | 0.81 |
| RLD16P700GMF | 9.1 | 12.1 | 5.1±0.7 | 7.6 | 3.2 | 1.3 | 4 | 0.81 |
| RLD16P700GMF-K | 9.1 | 16.6 | 5.1±0.7 | 7.6 | 3.2 | 1.3 | 3 | 0.81 |
| RLD16P800GMF | 9.3 | 12.8 | 5.1±0.7 | 7.6 | 3.2 | 1.3 | 4 | 0.81 |
| RLD16P800GMF-K | 9.3 | 17.3 | 5.1±0.7 | 7.6 | 3.2 | 1.3 | 3 | 0.81 |
| RLD16P900GMF | 10.0 | 13.4 | 5.1±0.7 | 7.6 | 3.2 | 1.3 | 4 | 0.81 |
| RLD16P900GMF-K | 10.0 | 17.9 | 5.1±0.7 | 7.6 | 3.2 | 1.3 | 3 | 0.81 |
| RLD16P1000GMF | 11.7 | 14.3 | 5.1±0.7 | 7.6 | 3.2 | 1.3 | 4 | 0.81 |
| RLD16P1000GMF-K | 11.7 | 18.8 | 5.1±0.7 | 7.6 | 3.2 | 1.3 | 3 | 0.81 |
| RLD16P1100GMF | 12.1 | 15.7 | 5.1±0.7 | 7.6 | 3.2 | 1.3 | 4 | 0.81 |
| RLD16P1100GMF-K | 12.1 | 20.2 | 5.1±0.7 | 7.6 | 3.2 | 1.3 | 3 | 0.81 |
| RLD16P1200GMF | 12.4 | 15.9 | 5.1±0.7 | 7.6 | 3.6 | 1.5 | 4 | 1.00 |
| RLD16P1400GMF | 13.0 | 16.3 | 5.1±0.7 | 7.6 | 3.6 | 1.5 | 4 | 1.00 |
| RLD16P1500GMF | 13.0 | 19.5 | 5.1±0.7 | 7.6 | 3.6 | 1.5 | 4 | 1.00 |
| RLD16P1750GMF | 14.3 | 19.0 | 10.2±1.0 | 7.6 | 4.0 | 1.7 | 4 | 1.20 |
| RLD16P2000GMF | 14.5 | 23.0 | 10.2±1.0 | 7.6 | 4.0 | 1.7 | 4 | 1.20 |

RLD 16V GMF Series PTC Devices

Recommend Pad Layout



| Part Number | A | B | D1 | D2 |
|---------------|------|-----|-----|-----|
| RLD16P250GMF | 5.1 | 0.8 | 1.0 | 2.5 |
| RLD16P300GMF | 5.1 | 1.1 | 1.5 | 3.5 |
| RLD16P400GMF | 5.1 | 1.1 | 1.5 | 3.5 |
| RLD16P500GMF | 5.1 | 1.3 | 1.5 | 3.5 |
| RLD16P600GMF | 5.1 | 1.3 | 1.5 | 3.5 |
| RLD16P700GMF | 5.1 | 1.3 | 1.5 | 3.5 |
| RLD16P800GMF | 5.1 | 1.3 | 1.5 | 3.5 |
| RLD16P900GMF | 5.1 | 1.3 | 1.5 | 3.5 |
| RLD16P1000GMF | 5.1 | 1.3 | 1.5 | 3.5 |
| RLD16P1100GMF | 5.1 | 1.3 | 1.5 | 3.5 |
| RLD16P1200GMF | 5.1 | 1.5 | 1.8 | 4.0 |
| RLD16P1400GMF | 5.1 | 1.5 | 1.8 | 4.0 |
| RLD16P1500GMF | 5.1 | 1.5 | 1.8 | 4.0 |
| RLD16P1750GMF | 10.2 | 1.7 | 2.1 | 4.5 |
| RLD16P2000GMF | 10.2 | 1.7 | 2.1 | 4.5 |

RLD 16V GMF Series PTC Devices

Wave Soldering Parameters

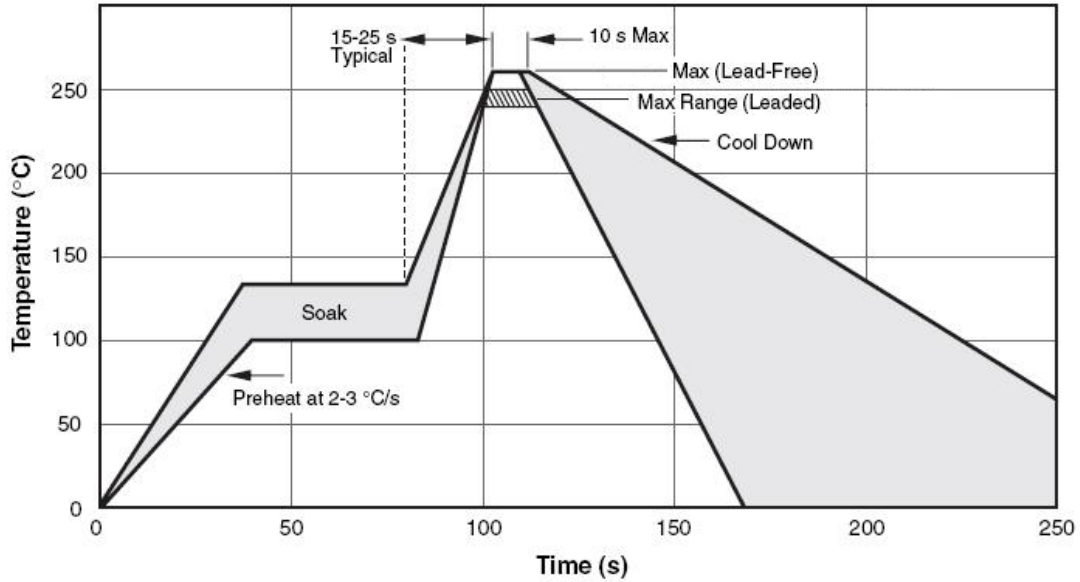

| Profile Feature | Pb-Free Assembly |
|---|--------------------|
| Average Ramp-Up Rate ($T_{s_{max}}$ to T_P) | 4°C/second max. |
| Preheat | |
| -Temperature Min ($T_{s_{min}}$) | 100°C |
| -Temperature Max ($T_{s_{max}}$) | 125°C |
| -Time ($T_{s_{min}}$ to $T_{s_{max}}$) | 60-180 seconds |
| Peak Temperature (T_P) | 265°C |
| Max Time at Peak Temperature (t_P) | 5 seconds |
| Ramp-Down Rate | 6°C /second max. |
| Time 25°C to Peak Temperature | 5 minutes max. |
| Storage Condition | 0°C ~35°C, ≤ 80%RH |

Note: If the wave soldering temperatures exceed the recommended profile, devices may not meet the performance requirements.

RLD 16V GMF Series PTC Devices

Environmental Specifications

| | |
|---|--|
| Operating Temperature | -40°C to +85 °C |
| Maximum Device Surface Temperature in Tripped State | 125°C |
| Passive Aging | +85°C , 1000 hours ±5% typical resistance change |
| Humidity Aging | +85°C , 85%R.H. 1000 hours ±5% typical resistance change |
| Thermal Shock | MIL-STD-202 Method 107G +85°C /-40°C 10 times -30% typical resistance change |
| Solvent Resistance | MIL-STD-202, Method 215 No change |
| Vibration | MIL-STD-883C, Method 2007.1, Condition A No change |
| Moisture Sensitivity Level | Level 1, J-STD-020C |

Physical Specifications

| | |
|---------------------------|--|
| Lead Material | P250GMF-P2000GMF: Tin-plated copper |
| Soldering Characteristics | Solderability per MIL-STD-202, Method 208E |
| Insulating Material | Cured, flame retardant epoxy polymer meets UL94V-0 requirements. |

RLD 16V GMF Series PTC Devices

Tape and Reel Specifications: EIA468-B/IEC60286-2

| Dimension Description | EIA Mark | IEC Mark | Dimensions | |
|--|----------------|----------------|-----------------|-------------|
| | | | Dim.(mm) | Tol.(mm) |
| Carrier tape width | W | W | 18 | -0.5/+1.0 |
| Hold down tape width | W ₄ | W ₀ | 11 | min. |
| Top distance between tape edges | W ₆ | W ₂ | 3 | max. |
| Sprocket hole position | W ₅ | W ₁ | 9 | -0.5+0.75 |
| Sprocket hole diameter* | D ₀ | D ₀ | 4 | -0.32/+0.2 |
| Abscissa to plane(straight lead) | H | H | 18.5 | ±3.0 |
| Abscissa to plane(kinked lead) | H ₀ | H ₀ | 16 | ±0.5 |
| Abscissa to top P250GMF-P900GMF | H ₁ | H ₁ | 32.2 | max. |
| Abscissa to top P1000GMF-P2000GMF | H ₁ | | 47.5 | max. |
| Overall width without lead protrusion: P250GMF-P900GMF | C ₁ | | 42.5 | max. |
| Overall width without lead protrusion: P1000GMF-P2000GMF | | | 57 | |
| Overall width with lead protrusion: P250GMF-P900GMF | C ₂ | | 43.2 | max. |
| Overall width with lead protrusion: P1000GMF-P2000GMF | | | 58 | |
| Lead protrusion | L ₁ | l ₁ | 1.0 | max. |
| Protrusion of cut out | L | L | 11 | max. |
| Protrusion beyond hold-down tape | l ₂ | l ₂ | Not specified | |
| Sprocket hole pitch: P250GMF-P1500GMF | P ₀ | P ₀ | 12.7 | ±0.3 |
| Sprocket hole pitch: P1750GMF-P2000GMF | P ₀ | P ₀ | 25.4 | ±0.5 |
| Pitch tolerance | | | 20 consecutive. | ±1 |
| Device pitch: P250GMF-P1500GMF | | | 12.7 | |
| Device pitch: P1750GMF-P2000GMF | | | 25.4 | |
| Tape thickness | t | t | 0.9 | max. |
| Tape thickness with splice | t ₁ | | 2.0 | max. |
| Splice sprocket hole alignment | | | 0 | ±0.3 |
| Body lateral deviation | Δh | Δh | 0 | ±1.0 |
| Body tape plane deviation | Δp | Δp | 0 | ±1.3 |
| Ordinate to adjacent component lead*: P250GMF-P1500GMF | P ₁ | P ₁ | 3.81 | ±0.7 |
| Ordinate to adjacent component lead*: P1750GMF-P2000GMF | | | 7.62 | ±0.7 |
| Lead spacing: P250GMF-P1500GMF | F | F | 5.08 | ±0.8 |
| Lead spacing: P1750GMF-P2000GMF | F | F | 10.18 | ±0.8 |
| Reel width P250GMF-P900GMF | w ₂ | w | 56 | max. |
| Reel width P1000GMF-P2000GMF | w ₂ | w | 63.5 | max. |
| Reel diameter | a | d | 370 | max. |
| Space between flanges less device* | w ₁ | | 4.75 | -3.25/+9.25 |
| Arbor hole diameter | c | f | 26 | ±12.0 |
| Core diameter* | n | h | 91 | max. |
| Box | | | 56/372/372 | max. |
| Consecutive missing places | | | None | |
| Empty places per reel | | | 0.1%max. | |

RLD 16V GMF Series PTC Devices

Tape and Reel Specifications: EIA468-B/IEC60286-2

(Continued)

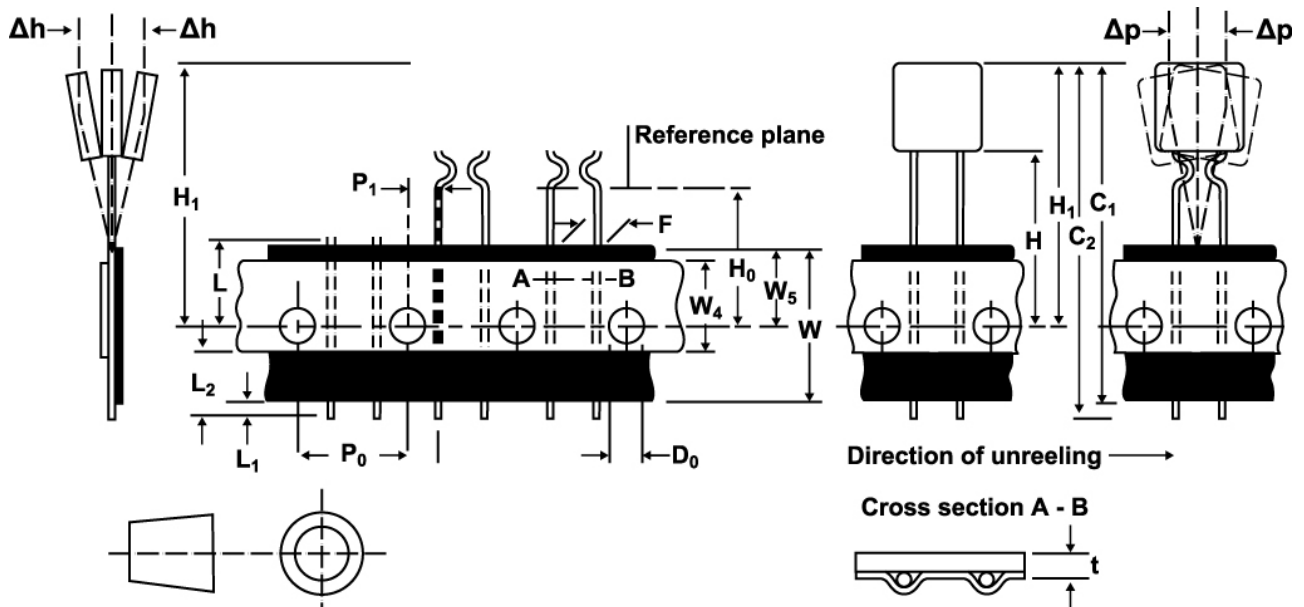

Fig. 1

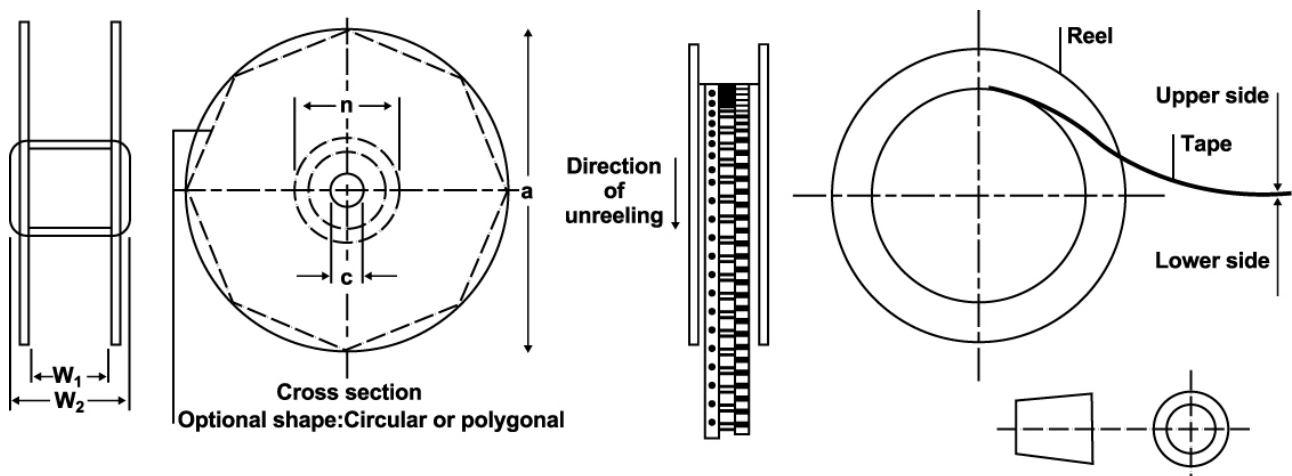
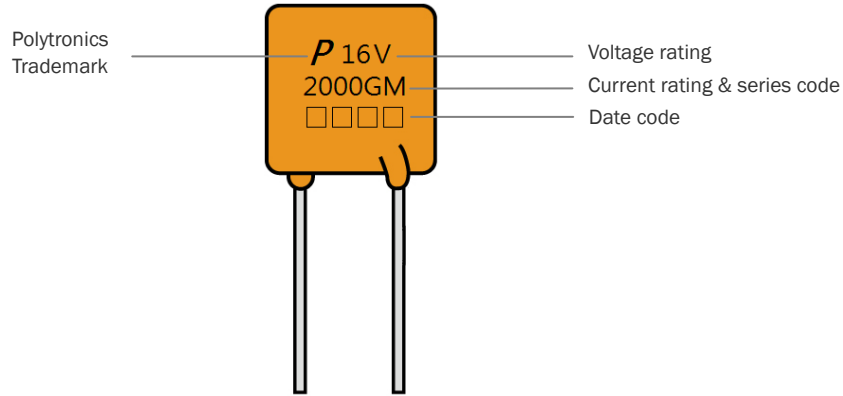

Fig. 2

RLD 16V GMF Series PTC Devices

Marking on Device



Part Ordering Number System

RLD 16 P □□□ **GMF -** □□

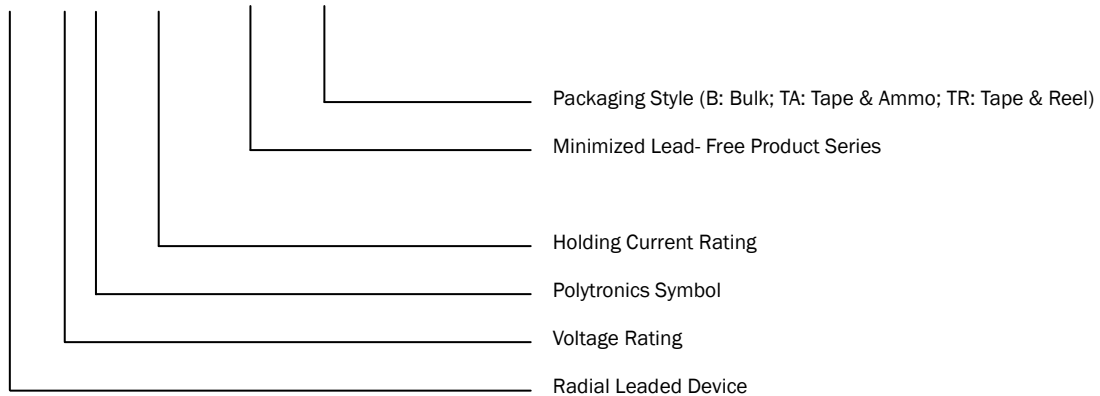

RLD 16V GMF Series PTC Devices

Packaging Quantity

| Part Number | Ordering Code | Bag Quantity | Reelpack Quantity | Ammopack Quantity |
|---------------|------------------|--------------|-------------------|-------------------|
| RLD16P250GMF | RLD16P250GMF-B | 500 | | |
| | RLD16P250GMF-TR | | 2000 | |
| | RLD16P250GMF-TA | | | 2000 |
| RLD16P300GMF | RLD16P300GMF-B | 500 | | |
| | RLD16P300GMF-TR | | 2000 | |
| | RLD16P300GMF-TA | | | 2000 |
| RLD16P400GMF | RLD16P400GMF-B | 500 | | |
| | RLD16P400GMF-TR | | 2000 | |
| | RLD16P400GMF-TA | | | 2000 |
| RLD16P500GMF | RLD16P500GMF-B | 500 | | |
| | RLD16P500GMF-TR | | 2000 | |
| | RLD16P500GMF-TA | | | 2000 |
| RLD16P600GMF | RLD16P600GMF-B | 500 | | |
| | RLD16P600GMF-TR | | 2000 | |
| | RLD16P600GMF-TA | | | 2000 |
| RLD16P700GMF | RLD16P700GMF-B | 500 | | |
| | RLD16P700GMF-TR | | 2000 | |
| | RLD16P700GMF-TA | | | 2000 |
| RLD16P800GMF | RLD16P800GMF-B | 500 | | |
| | RLD16P800GMF-TR | | 2000 | |
| | RLD16P800GMF-TA | | | 2000 |
| RLD16P900GMF | RLD16P900GMF-B | 500 | | |
| | RLD16P900GMF-TR | | 2000 | |
| | RLD16P900GMF-TA | | | 2000 |
| RLD16P1000GMF | RLD16P1000GMF-B | 500 | | |
| | RLD16P1000GMF-TR | | 1500 | |
| | RLD16P1000GMF-TA | | | 1500 |
| RLD16P1100GMF | RLD16P1100GMF-B | 500 | | |
| | RLD16P1100GMF-TR | | 1500 | |
| | RLD16P1100GMF-TA | | | 1500 |
| RLD16P1200GMF | RLD16P1200GMF-B | 500 | | |
| | RLD16P1200GMF-TR | | 1500 | |
| | RLD16P1200GMF-TA | | | 1500 |
| RLD16P1400GMF | RLD16P1400GMF-B | 500 | | |
| | RLD16P1400GMF-TR | | 1500 | |
| | RLD16P1400GMF-TA | | | 1500 |
| RLD16P1500GMF | RLD16P1500GMF-B | 500 | | |
| | RLD16P1500GMF-TR | | 1500 | |
| | RLD16P1500GMF-TA | | | 1500 |
| RLD16P1750GMF | RLD16P1750GMF-B | 200 | | |
| RLD16P2000GMF | RLD16P2000GMF-B | 200 | | |

单击下面可查看定价，库存，交付和生命周期等信息

>> [聚鼎](#)