



## RLD 60V XMF Series PTC Devices

## RLD 60V XMF Series PTC Devices

### Description

The RLD60P XMF series provides radial leaded resettable over-current protection with holding current from 0.25A to 5.0A. This series is suitable for wide range of applications in modern electronics and automotive industry.

### Features





- RoHS compliant and lead-free
- Halogen-free
- Fast time-to-trip
- 60Vdc operating voltage
- 40A maximum short current
- Compact design saves board space



### Applications

- Powered supplies
- Industrial controls
- General electronics
- Security systems
- Automotive applications
- Motor protection

### Agency Approval and Environmental Compliance



Agency	File Number	Regulation	Standard
	E201431		2011/65/EU
	R50103284		IEC 61249-2-21:2003

### Electrical Characteristics

Part Number	I <sub>hold</sub> (A)	I <sub>trip</sub> (A)	V <sub>max</sub> (Vdc)	I <sub>max</sub> (A)	P <sub>d typ</sub> (W)	Maximum Time To Trip		Resistance		Agency Approval	
						Current (A)	Time (Sec.)	R <sub>min</sub> (Ω)	R <sub>1max</sub> (Ω)		
RLD60P025XMF	0.25	0.5	60	40	0.6	1.25	1.3	0.900	2.700	✓	✓
RLD60P030XMF	0.30	0.6	60	40	0.6	1.50	1.7	0.700	2.200	✓	✓
RLD60P040XMF	0.40	0.8	60	40	0.7	2.00	2.2	0.450	1.400	✓	✓
RLD60P050XMF	0.50	1.0	60	40	0.7	2.50	2.5	0.300	1.000	✓	✓
RLD60P065XMF	0.65	1.3	60	40	0.7	3.25	3.5	0.200	0.800	✓	✓
RLD60P075XMF	0.75	1.5	60	40	1.0	3.75	3.6	0.200	0.750	✓	✓
RLD60P090XMF	0.90	1.8	60	40	1.1	4.50	3.7	0.170	0.600	✓	✓
RLD60P110XMF	1.10	2.2	60	40	1.5	5.50	4.0	0.130	0.500	✓	✓
RLD60P135XMF	1.35	2.7	60	40	1.6	6.75	4.3	0.100	0.400	✓	✓
RLD60P160XMF	1.60	3.2	60	40	1.8	8.00	4.5	0.070	0.300	✓	✓
RLD60P185XMF	1.85	3.7	60	40	2.0	9.25	4.7	0.060	0.250	✓	✓
RLD60P250XMF	2.50	5.0	60	40	2.2	12.50	5.0	0.045	0.200	✓	✓
RLD60P300XMF	3.00	6.0	60	40	2.4	15.00	5.5	0.035	0.170	✓	✓
RLD60P375XMF	3.75	7.5	60	40	2.7	18.75	6.0	0.022	0.130	✓	✓

## RLD 60V XMF Series PTC Devices

(Continued)

Part Number	I <sub>hold</sub> (A)	I <sub>trip</sub> (A)	V <sub>max</sub> (Vdc)	I <sub>max</sub> (A)	P <sub>d typ</sub> (W)	Maximum Time To Trip		Resistance		Agency Approval	
						Current (A)	Time (Sec.)	R <sub>min</sub> (Ω)	R <sub>1max</sub> (Ω)		
RLD60P400XMF	4.00	8.0	60	40	3.0	20.00	6.7	0.018	0.100	✓	✓
RLD60P500XMF	5.00	10.0	60	40	3.7	25.00	8.5	0.010	0.060	✓	✓

### Note on Electrical Characteristics

#### ■ Vocabulary

I<sub>hold</sub> = Hold current: maximum current device will pass without tripping in 23°C still air.

I<sub>trip</sub> = Trip current: minimum current at which the device will trip in 23°C still air.

V<sub>max</sub> = Maximum voltage device can withstand without damage at rated current (I<sub>max</sub>)

I<sub>max</sub> = Maximum fault current device can withstand without damage at rated voltage (V<sub>max</sub>)

P<sub>d typ</sub> = Typical power dissipated from device when in the tripped state at 23°C still air.

R<sub>min</sub> = Minimum resistance of device in initial (un-soldered) state.

R<sub>1max</sub> = Maximum resistance of device at 23°C measured one hour after tripping or reflow soldering of 260°C for 20 sec.

■ **Caution: Operation beyond the specified rating may result in damage and possible arcing and flame.**

■ **Specifications are subject to change without notice.**

## RLD 60V XMF Series PTC Devices

### Polymeric PTC Selecting Guide

■ Determine the following operating parameters for the circuits:

- Normal operating current ( $I_{hold}$ )
- Maximum interrupt current ( $I_{max}$ )
- Maximum circuit voltage ( $V_{max}$ )
- Normal operating temperature surrounding device (min°C/max°C)

■ Select the device form factor and dimension suitable for the application:

- Surface Mount Device (SMD)
- Axial Leaded Device (ALD)
- Other Customized Form Factors
- Radial Leaded Device (RLD)
- DISC Device

■ Compare the maximum rating for  $V_{max}$  and  $I_{max}$  of the PPTC device with the circuit in application and make sure the circuit's requirement does not exceed the device rating.

■ Check that PPTC device's trip time (time-to-trip) will protect the circuit.

■ Verify that the circuit operating temperature is within the PPTC device's normal operating temperature range.

■ Verify the performance and suitability of the chosen PPTC device in the application.

### **WARNING**

■ **Mechanical Stress**

- PPTC devices will undergo a thermal expansion during fault condition. If PPTC devices are installed or placed in an application where the space between PPTC devices and the surrounding materials (e.g., covering materials, packaging materials, encapsulate materials and the like) is insufficient, it will cause an inhibiting effect upon the thermal expansion. Pressing, twisting, bending and other kinds of mechanical stress will also adversely affect the performance of the PPTC devices, and shall not be used or applied.

■ **Chemical Pollutants**

- Silicone-based oils, oils, solvents, gels, electrolytes, fuels, acids, and the like will adversely affect the properties of PPTC devices, and shall not be used or applied.

■ **Electronic and Thermal Effect**

- PPTC devices are secondary protection devices and are used solely for sporadic, accidental over-current or over-temperature error condition, and shall NOT be used if or when constant or repeated fault conditions (such fault conditions may be caused by, among others, incorrect pin-connection of a connector) or over-extensive trip events may occur.
- PPTC devices are different from fuses and, when a fault condition occurs, will go into high-resistance state and do not open circuit, in which case the voltage at such PPTC devices may reach a hazardous level.
- Operation over the maximum rating or other forms of improper use may cause failure, arcing, flame and/or other damage to the PPTC devices.
- Conductive material contamination, such as metal particle, may induce shortage, flame or arcing.
- Due to the inductance, the operation circuits may generate a circuit voltage ( $Ldi/dt$ ) above the rated voltage of PPTC devices, which shall not be used under such circumstances.

■ **General**

- Customers shall evaluate and test the properties of PPTC devices independently to verify and ensure that their individual applications will be met.
- The performance of PPTC devices will be adversely affected if they are improperly used under electronic, thermal and/or mechanical procedures and/or conditions non-conformant to those recommended by manufacturer.
- Customers shall be responsible for determining whether it is necessary to have back-up, failsafe and/or fool-proof protection to avoid or minimize damage that may result from extra-ordinary, irregular function or failure of PPTC devices.
- Any and all responsibilities and liabilities are disclaimed if any item under this notice of warning is not complied with.

## RLD 60V XMF Series PTC Devices

### Average Time-to-Trip Curves

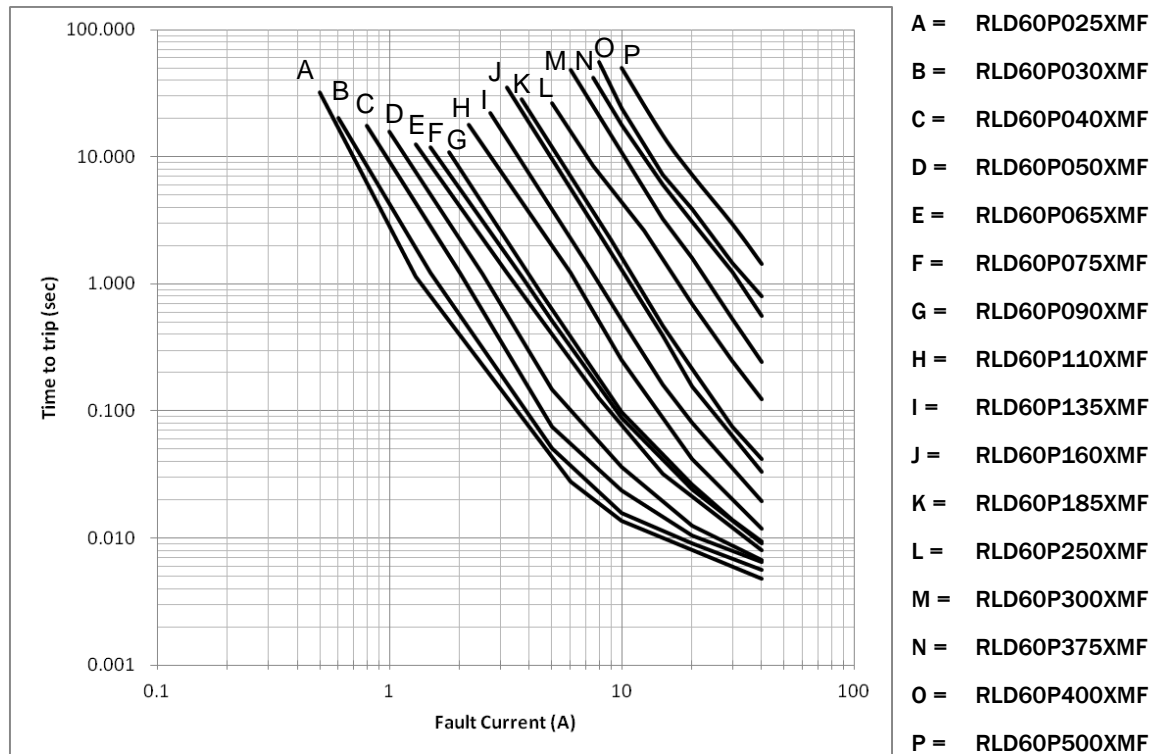

## RLD 60V XMF Series PTC Devices

### Thermal Derating Curve

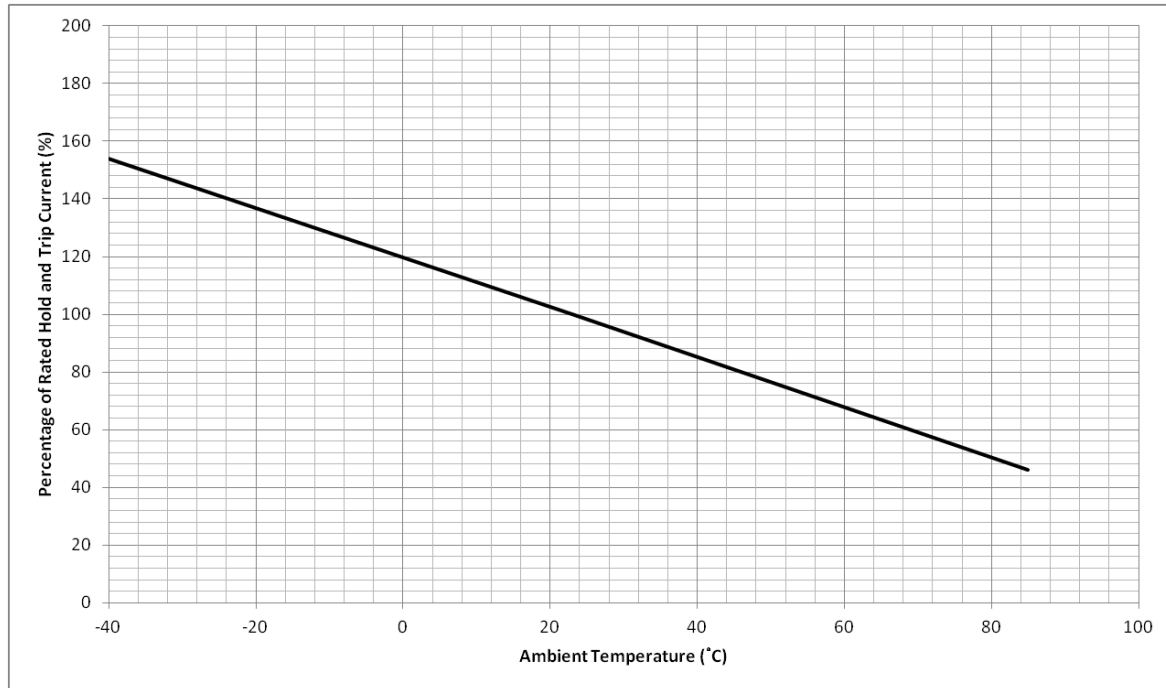

### Thermal Derating Table

#### Recommended Hold Current (A) vs. Ambient Temperature (°C)

Part Number	Ambient Operation Temperature								
	-40 °C	-20 °C	0 °C	23 °C	40 °C	50 °C	60 °C	70 °C	85 °C
RLD60P025XMF	0.39	0.34	0.30	0.25	0.21	0.19	0.17	0.15	0.12
RLD60P030XMF	0.46	0.41	0.36	0.30	0.26	0.23	0.20	0.18	0.14
RLD60P040XMF	0.62	0.55	0.48	0.40	0.34	0.31	0.27	0.24	0.18
RLD60P050XMF	0.77	0.68	0.60	0.50	0.43	0.38	0.34	0.30	0.23
RLD60P065XMF	1.00	0.89	0.78	0.65	0.55	0.50	0.44	0.38	0.30
RLD60P075XMF	1.16	1.03	0.90	0.75	0.64	0.57	0.51	0.44	0.35
RLD60P090XMF	1.39	1.23	1.08	0.90	0.77	0.69	0.61	0.53	0.41
RLD60P110XMF	1.69	1.51	1.32	1.10	0.94	0.84	0.75	0.65	0.51
RLD60P135XMF	2.08	1.85	1.62	1.35	1.15	1.03	0.91	0.80	0.62
RLD60P160XMF	2.46	2.19	1.92	1.60	1.36	1.22	1.08	0.95	0.74
RLD60P185XMF	2.85	2.53	2.21	1.85	1.58	1.41	1.25	1.09	0.85
RLD60P250XMF	3.85	3.42	2.99	2.50	2.13	1.91	1.69	1.48	1.15
RLD60P300XMF	4.62	4.11	3.59	3.00	2.56	2.29	2.03	1.77	1.38
RLD60P375XMF	5.78	5.13	4.49	3.75	3.19	2.87	2.54	2.21	1.73
RLD60P400XMF	6.16	5.47	4.79	4.00	3.41	3.06	2.71	2.36	1.84
RLD60P500XMF	7.70	6.84	5.99	5.00	4.26	3.82	3.39	2.95	2.30

## RLD 60V XMF Series PTC Devices

### Physical Dimensions (mm.)

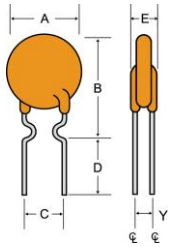

Fig. 1

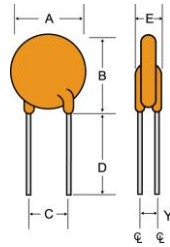

Fig. 2

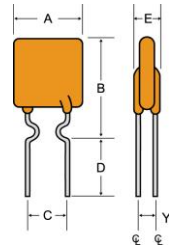

Fig. 3

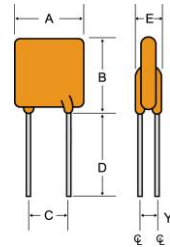

Fig. 4

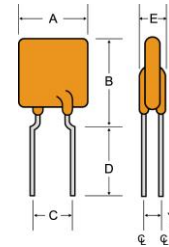
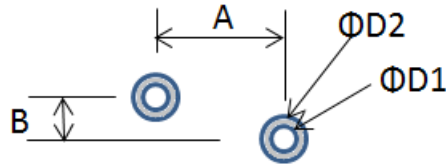

Fig. 5

Part Number	A Max.	B Max.	C Typ.	D Min.	E Max.	Y	Fig.	Lead Dia.
						Typ.		
RLD60P025XMF	7.4	11.6	5.1±0.7	7.6	3.2	1.1	1	0.51
RLD60P025XMF-S	7.4	7.6	5.1±0.7	7.6	3.2	1.1	2	0.51
RLD60P030XMF	7.4	12.7	5.1±0.7	7.6	3.2	1.1	1	0.51
RLD60P030XMF-S	7.4	8.7	5.1±0.7	7.6	3.2	1.1	2	0.51
RLD60P040XMF	7.4	13.4	5.1±0.7	7.6	3.2	1.1	1	0.51
RLD60P040XMF-S	7.4	9.4	5.1±0.7	7.6	3.2	1.1	2	0.51
RLD60P050XMF	7.6	13.8	5.1±0.7	7.6	3.2	1.1	1	0.51
RLD60P050XMF-S	7.6	9.8	5.1±0.7	7.6	3.2	1.1	2	0.51
RLD60P065XMF	7.6	12.9	5.1±0.7	7.6	3.2	1.1	3	0.51
RLD60P065XMF-S	7.6	10.6	5.1±0.7	7.6	3.2	1.1	4	0.51
RLD60P075XMF	7.6	13.2	5.1±0.7	7.6	3.2	1.1	3	0.51
RLD60P075XMF-S	7.6	10.6	5.1±0.7	7.6	3.2	1.1	4	0.51
RLD60P090XMF	7.8	14.2	5.1±0.7	7.6	3.2	1.1	3	0.51
RLD60P090XMF-S	7.8	12.0	5.1±0.7	7.6	3.2	1.1	4	0.51
RLD60P110XMF	8.0	14.9	5.1±0.7	7.6	3.8	1.4	3	0.81
RLD60P135XMF	8.9	15.2	5.1±0.7	7.6	3.8	1.4	3	0.81
RLD60P135XMF-S	8.9	12.8	5.1±0.7	7.6	3.8	1.4	4	0.81
RLD60P160XMF	10.2	15.7	5.1±0.7	7.6	3.8	1.4	3	0.81
RLD60P160XMF-S	10.2	13.8	5.1±0.7	7.6	3.8	1.4	4	0.81
RLD60P185XMF	11.2	16.5	5.1±0.7	7.6	3.8	1.4	3	0.81
RLD60P185XMF-S	11.2	14.4	5.1±0.7	7.6	3.8	1.4	4	0.81
RLD60P250XMF	12.5	19.1	5.1±0.7	7.6	3.8	1.4	3	0.81
RLD60P250XMF-S	12.5	16.5	5.1±0.7	7.6	3.8	1.4	4	0.81
RLD60P300XMF	14.0	22.0	5.1±0.7	7.6	3.8	1.4	3	0.81
RLD60P300XMF-S	14.0	18.3	5.1±0.7	7.6	3.8	1.4	4	0.81
RLD60P375XMF	14.0	25.6	5.1±0.7	7.6	3.8	1.4	3	0.81
RLD60P375XMF-S	14.0	23.0	5.1±0.7	7.6	3.8	1.4	4	0.81
RLD60P400XMF	15.1	26.0	10.2±1.0	7.6	3.8	1.4	3	0.81
RLD60P400XMF-S	15.1	23.4	10.2±1.0	7.6	3.8	1.4	4	0.81
RLD60P500XMF	19.1	28.6	10.2±1.0	7.6	3.8	1.4	3	0.81
RLD60P500XMF-S	19.1	25.0	10.2±1.0	7.6	3.8	1.4	4	0.81

## RLD 60V XMF Series PTC Devices

### Recommend Pad Layout (mm)



Part Number	A (Typ.)	B (Typ.)	D1 (Typ.)	D2 (Typ.)
RLD60P025XMF	5.1	1.1	1.0	2.5
RLD60P030XMF	5.1	1.1	1.0	2.5
RLD60P040XMF	5.1	1.1	1.0	2.5
RLD60P050XMF	5.1	1.1	1.0	2.5
RLD60P065XMF	5.1	1.1	1.0	2.5
RLD60P075XMF	5.1	1.1	1.0	2.5
RLD60P090XMF	5.1	1.1	1.0	2.5
RLD60P110XMF	5.1	1.4	1.5	3.5
RLD60P135XMF	5.1	1.4	1.5	3.5
RLD60P160XMF	5.1	1.4	1.5	3.5
RLD60P185XMF	5.1	1.4	1.5	3.5
RLD60P250XMF	5.1	1.4	1.5	3.5
RLD60P300XMF	5.1	1.4	1.5	3.5
RLD60P375XMF	5.1	1.4	1.5	3.5
RLD60P400XMF	10.2	1.4	1.5	3.5
RLD60P500XMF	10.2	1.4	1.5	3.5



## RLD 60V XMF Series PTC Devices

### Wave Soldering Parameters

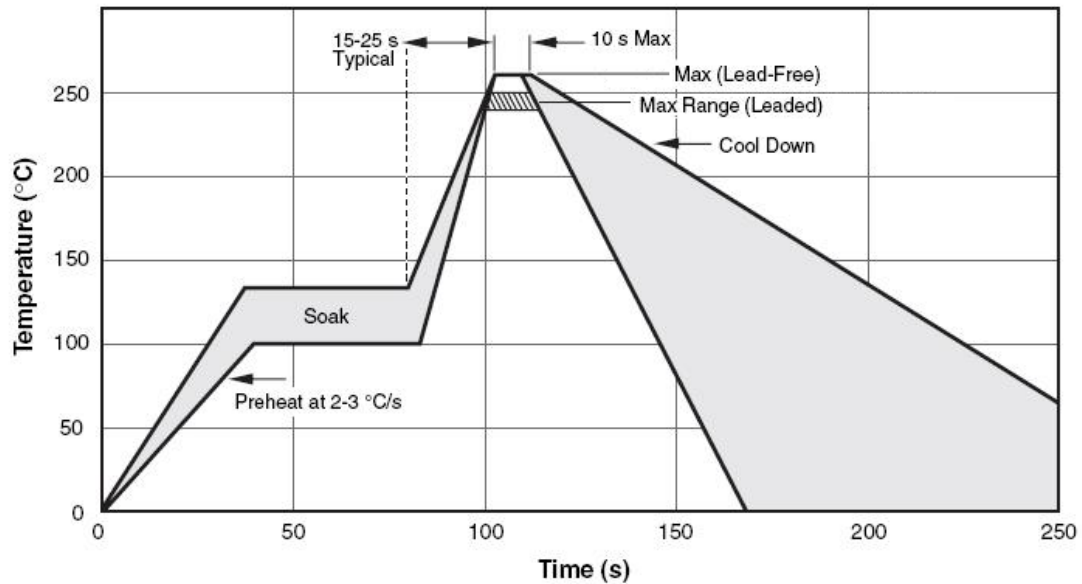

Profile Feature	Pb-Free Assembly
Average Ramp-Up Rate (T <sub>Smax</sub> to T <sub>P</sub> )	4°C/second max.
<b>Preheat</b>	
-Temperature Min (T <sub>Smin</sub> )	100°C
-Temperature Max (T <sub>Smax</sub> )	125°C
-Time (T <sub>Smin</sub> to T <sub>Smax</sub> )	60-180 seconds
Peak Temperature (T <sub>P</sub> )	265°C
Max Time at Peak Temperature (t <sub>P</sub> )	5 seconds
Ramp-Down Rate	6°C /second max.
Time 25°C to Peak Temperature	5 minutes max.
Storage Condition	0°C ~35°C, ≤ 80%RH

**Note:** If the wave soldering temperatures exceed the recommended profile, devices may not meet the performance requirements.

## RLD 60V XMF Series PTC Devices

### Environmental Specifications

Operating Temperature	-40°C to +85 °C
Maximum Device Surface Temperature in Tripped State	125°C
Passive Aging	+85°C , 1000 hours ±5% typical resistance change
Humidity Aging	+85°C , 85%R.H. 1000 hours ±5% typical resistance change
Thermal Shock	MIL-STD-202 Method 107G +85°C /-40°C 10 times -30% typical resistance change
Solvent Resistance	MIL-STD-202, Method 215 No change
Vibration	MIL-STD-883C, Method 2007.1, Condition A No change
Moisture Sensitivity Level	Level 1, J-STD-020C

### Physical Specifications

Lead Material	P025XMF-P065XMF: Tin-plated copper clad steel P075XMF-P500XMF: Tin-plated copper
Soldering Characteristics	Solderability per MIL-STD-202, Method 208E
Insulating Material	Cured, flame retardant epoxy polymer meets UL94V-0 requirements.

## RLD 60V XMF Series PTC Devices

### Tape and Reel Specifications: EIA468-B/IEC60286-2

Dimension Description	EIA Mark	IEC Mark	Dimensions	
			Dim.(mm)	Tol.(mm)
Carrier tape width	W	W	18	-0.5/+1.0
Hold down tape width	W <sub>4</sub>	W <sub>0</sub>	11	min.
Top distance between tape edges	W <sub>6</sub>	W <sub>2</sub>	3	max.
Sprocket hole position	W <sub>5</sub>	W <sub>1</sub>	9	-0.5+0.75
Sprocket hole diameter*	D <sub>0</sub>	D <sub>0</sub>	4	-0.32/+0.2
Abscissa to plane(straight lead)	H	H	18.5	+3.0
Abscissa to plane(kinked lead)	H <sub>0</sub>	H <sub>0</sub>	16	+0.5
Abscissa to top P025XMF-P160XMF	H <sub>1</sub>	H <sub>1</sub>	32.2	max.
Abscissa to top P185XMF-P500XMF	H <sub>1</sub>		47.5	max.
Overall width without lead protrusion: P025XMF-P160XMF	C <sub>1</sub>		42.5	max.
Overall width without lead protrusion: P185XMF-P500XMF			57	
Overall width with lead protrusion: P025XMF-P160XMF	C <sub>2</sub>		43.2	max.
Overall width with lead protrusion: P185XMF-P500XMF			58	
Lead protrusion	L <sub>1</sub>	l <sub>1</sub>	1.0	max.
Protrusion of cut out	L	L	11	max.
Protrusion beyond hold-down tape	l <sub>2</sub>	l <sub>2</sub>	Not specified	
Sprocket hole pitch: P025XMF-P250XMF	P <sub>0</sub>	P <sub>0</sub>	12.7	+0.3
Sprocket hole pitch: P300XMF-P500XMF	P <sub>0</sub>	P <sub>0</sub>	25.4	+0.5
Pitch tolerance			20 consecutive.	+1
Device pitch: P025XMF-P250XMF			12.7	
Device pitch: P300XMF-P500XMF			25.4	
Tape thickness	t	t	0.9	max.
Tape thickness with splice	t <sub>1</sub>		2.0	max.
Splice sprocket hole alignment			0	+0.3
Body lateral deviation	Δh	Δh	0	+1.0
Body tape plane deviation	Δp	Δp	0	+1.3
Ordinate to adjacent component lead*: P025XMF-P375XMF	P <sub>1</sub>	P <sub>1</sub>	3.81	+0.7
Ordinate to adjacent component lead*: P400XMF-P500XMF			7.62	+0.7
Lead spacing: P025XMF-P375XMF	F	F	5.08	+0.8
Lead spacing: P400XMF-P500XMF	F	F	10.18	+0.8
Reel width P025XMF-P375XMF	w <sub>2</sub>	w	56	max.
Reel width P400XMF-P500XMF	w <sub>2</sub>	w	63.5	max.
Reel diameter	a	d	370	max.
Space between flanges less device*	w <sub>1</sub>		4.75	-3.25/+9.25
Arbor hole diameter	c	f	26	+12.0
Core diameter*	n	h	91	max.
Box			56/372/372	max.
Consecutive missing places			None	
Empty places per reel			0.1%max.	

## RLD 60V XMF Series PTC Devices

Tape and Reel Specifications: EIA468-B/IEC60286-2

(Continued)

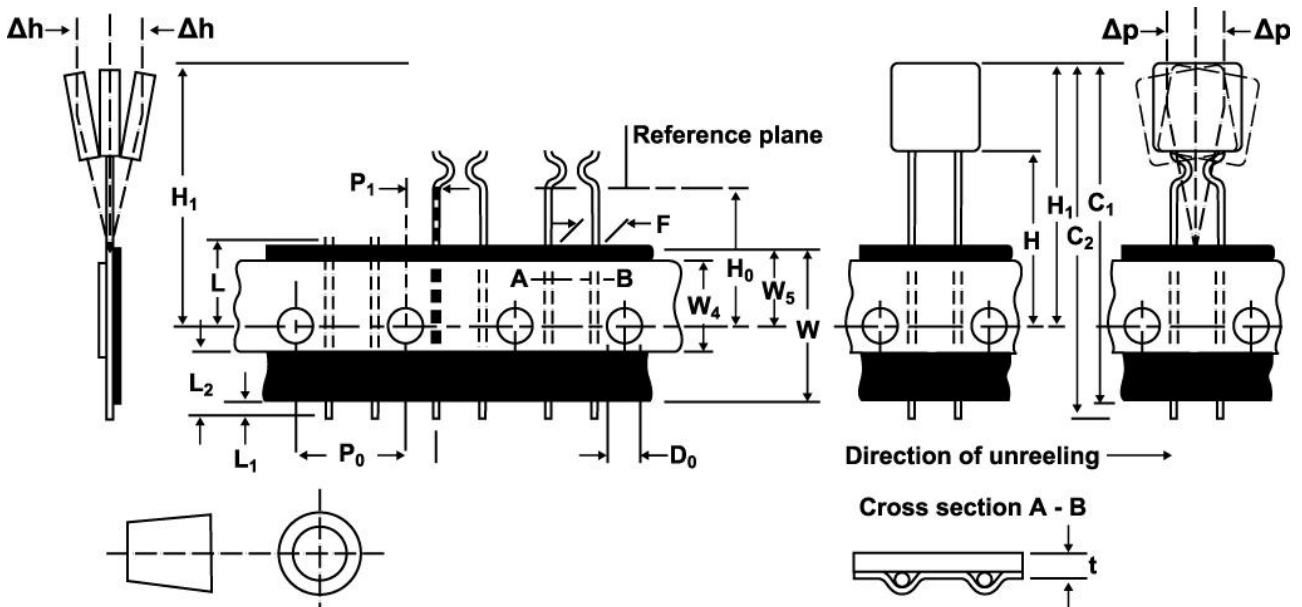

Fig. 1

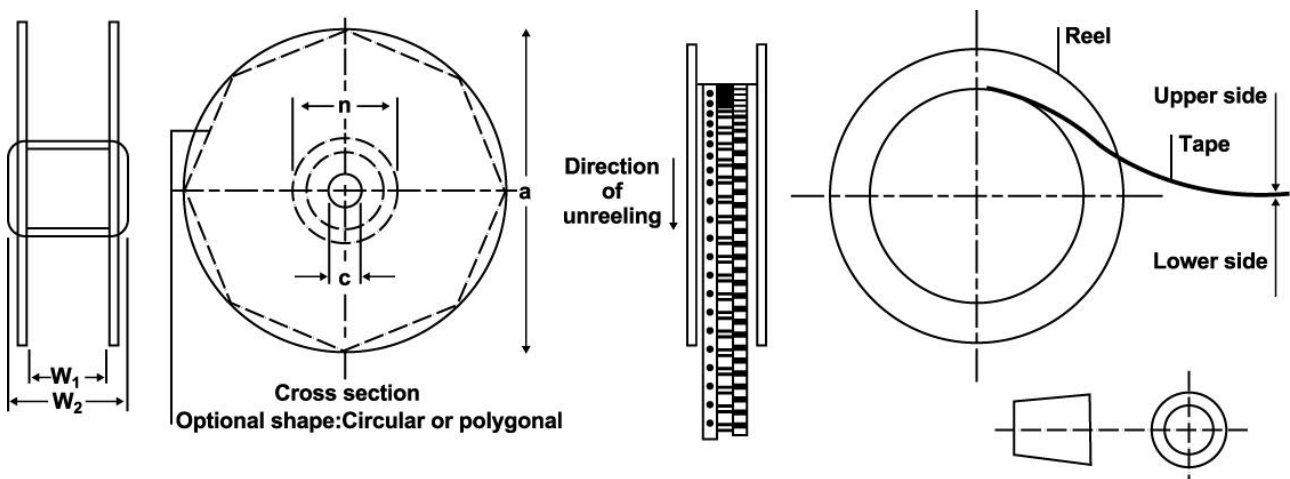
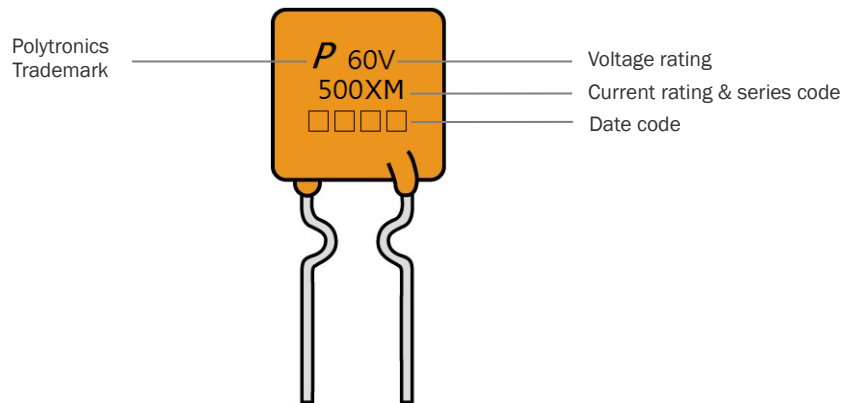

Fig. 2

## RLD 60V XMF Series PTC Devices

### Marking on Device



### Part Ordering Number System

**RLD 60 P** □□□ **XMF** - □□

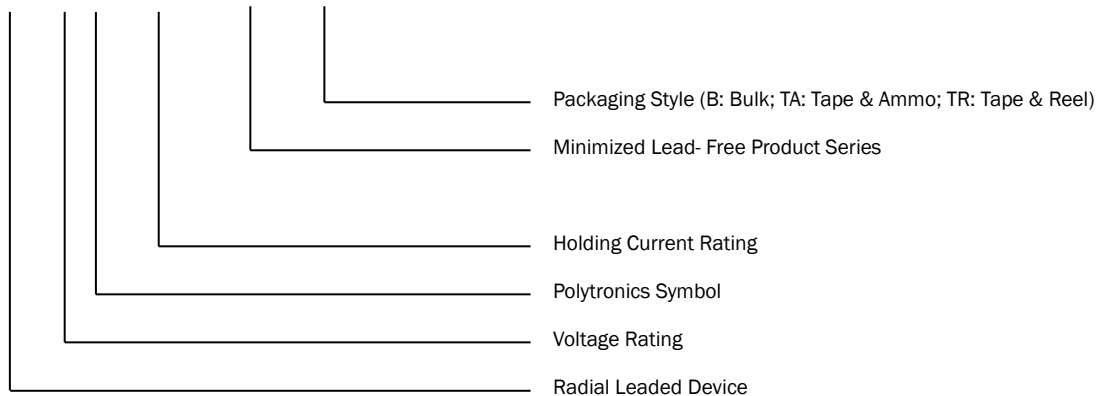

## RLD 60V XMF Series PTC Devices

### Packaging Quantity

Part Number	Ordering Code	Bag Quantity	Reelpack Quantity	Ammopack Quantity
RLD60P025XMF	RLD60P025XMF-B	500		
	RLD60P025XMF-TR		2000	
	RLD60P025XMF-TA			2000
RLD60P030XMF	RLD60P030XMF-B	500		
	RLD60P030XMF-TR		2000	
	RLD60P030XMF-TA			2000
RLD60P040XMF	RLD60P040XMF-B	500		
	RLD60P040XMF-TR		2000	
	RLD60P040XMF-TA			2000
RLD60P050XMF	RLD60P050XMF-B	500		
	RLD60P050XMF-TR		2000	
	RLD60P050XMF-TA			2000
RLD60P065XMF	RLD60P065XMF-B	500		
	RLD60P065XMF-TR		2000	
	RLD60P065XMF-TA			2000
RLD60P075XMF	RLD60P075XMF-B	500		
	RLD60P075XMF-TR		2000	
	RLD60P075XMF-TA			2000
RLD60P090XMF	RLD60P090XMF-B	500		
	RLD60P090XMF-TR		2000	
	RLD60P090XMF-TA			2000
RLD60P110XMF	RLD60P110XMF-B	500		
	RLD60P110XMF-TR		1500	
	RLD60P110XMF-TA			1500
RLD60P135XMF	RLD60P135XMF-B	500		
	RLD60P135XMF-TR		1500	
	RLD60P135XMF-TA			1500
RLD60P160XMF	RLD60P160XMF-B	500		
	RLD60P160XMF-TR		1500	
	RLD60P160XMF-TA			1500
RLD60P185XMF	RLD60P185XMF-B	500		
	RLD60P185XMF-TR		1500	
	RLD60P185XMF-TA			1500
RLD60P250XMF	RLD60P250XMF-B	500		
	RLD60P250XMF-TR		1500	
	RLD60P250XMF-TA			1500
RLD60P300XMF	RLD60P300XMF-B	200		
	RLD60P300XMF-TR		1000	
	RLD60P300XMF-TA			1000
RLD60P375XMF	RLD60P375XMF-B	200		
	RLD60P375XMF-TR		1000	
	RLD60P375XMF-TA			1000

## RLD 60V XMF Series PTC Devices

Part Number	Ordering Code	Bag Quantity	Reelpack Quantity	Ammopack Quantity
RLD60P400XMF	RLD60P400XMF-B	200		
	RLD60P400XMF-TR		1000	
	RLD60P400XMF-TA			1000
RLD60P500XMF	RLD60P500XMF-B	200		
	RLD60P500XMF-TR		1000	
	RLD60P500XMF-TA			1000

单击下面可查看定价，库存，交付和生命周期等信息

[>>聚鼎](#)