



RF360
Europe GmbH

Data sheet

Micro-acoustic diplexer
GPS L5 + GNSS L1

Part number:	B1267
Ordering code:	B39162B1267L210
Date:	May 29, 2020
Version:	2.0

DCN: 80-PA243-479 Rev. A

RF360 products mentioned within this document are products of RF360 Europe GmbH and other subsidiaries of RF360 Holdings Singapore Pte. Ltd. (collectively, the "RF360 Subsidiaries").

RF360 Europe GmbH, Anzinger Str. 13, München, Germany

© 2020 RF360 Europe GmbH and/or its affiliated companies. All rights reserved.

These materials, including the information contained herein, may be used only for informational purposes by the customer. The RF360 Subsidiaries assume no responsibility for errors or omissions in these materials or the information contained herein. The RF360 Subsidiaries reserve the right to make changes to the product(s) or information contained herein without notice. The materials and information are provided on an AS IS basis, and the RF360 Subsidiaries assume no liability and make no warranty or representation, either expressed or implied, with respect to the materials, or any output or results based on the use, application, or evaluation of such materials, including, without limitation, with respect to the non-infringement of trademarks, patents, copyrights or any other intellectual property rights or other rights of third parties.

No use of this documentation or any information contained herein grants any license, whether express, implied, by estoppel or otherwise, to any intellectual property rights, including, without limitation, to any patents owned by QUALCOMM Incorporated or any of its subsidiaries.

Not to be used, copied, reproduced, or modified in whole or in part, nor its contents revealed in any manner to others without the express written permission of RF360 Europe GmbH.

Qualcomm is a trademark of Qualcomm Incorporated, registered in the United States and other countries. Other product and brand names may be trademarks or registered trademarks of their respective owners.

This technical data may be subject to U.S. and international export, re-export, or transfer ("export") laws. Diversion contrary to U.S. and international law is strictly prohibited.

Table of contents

1	Application	4
2	Features	4
3	Package	5
4	Pin configuration	5
5	Matching circuit	6
6	Characteristics ANT – GPS L5	7
7	Characteristics ANT – GNSS L1	8
8	Maximum ratings	10
9	Transmission coefficient ANT – GPS L5	11
10	Reflection coefficients ANT – GPS L5	12
11	Transmission coefficient ANT – GNSS L1	13
12	Reflection coefficients ANT – GNSS L1	14
13	Packing material	15
14	Marking	19
15	Soldering profile	20
16	Annotations	21
17	Cautions and warnings	22
18	Important notes	23

1 Application

- Diplexer for GPS L5 and GNSS L1 navigation bands with single ended 50Ω ports.
- Ultra-low-loss acoustic structure.
- Highly integrated with no external matching.
- Usable GNSS L1 pass bands: 1559.05 – 1563.15 MHz (BeiDou), 1574.39 – 1576.45 MHz (GPS), 1597.55 – 1605.89 MHz (Glonass).
Usable GPS L5 pass band: 1166.22 – 1186.68 MHz.

2 Features

- Package height 0.6 mm
- Package size 1.5 mm × 1.1 mm
- RoHS compatible
- Package for Surface Mount Technology (SMT)
- Ni/Au-plated terminals
- Electrostatic Sensitive Device (ESD)
- Moisture Sensitivity Level 3 (MSL3)

3 Package

BOTTOM VIEW

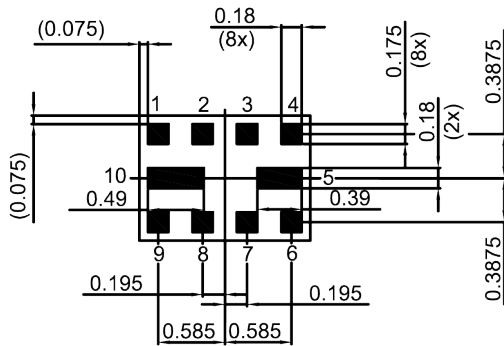

Pad and pitch tolerance ± 0.05

SIDE VIEW



TOP VIEW

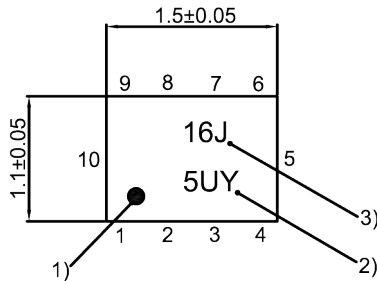

- 1) Marking for pad number 1
- 2) Example of encoded lot number
- 3) Example of encoded filter type number

Land pattern
THRU VIEW

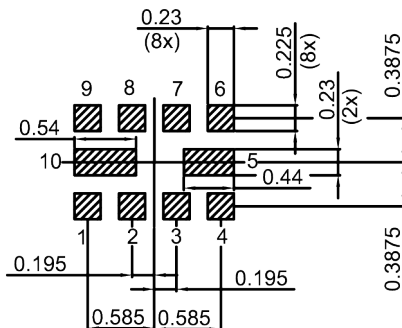

Landing pad tolerance -0.02

4 Pin configuration

- 1 ANT
- 6 GPS L5
- 9 GNSS L1
- 2, 3, 4, 5, 7, 8, 10 Ground

Figure 1: Drawing of package with package height A = 0.7 mm (max.). See Sec. Package information (p. 22).

5 Matching circuit

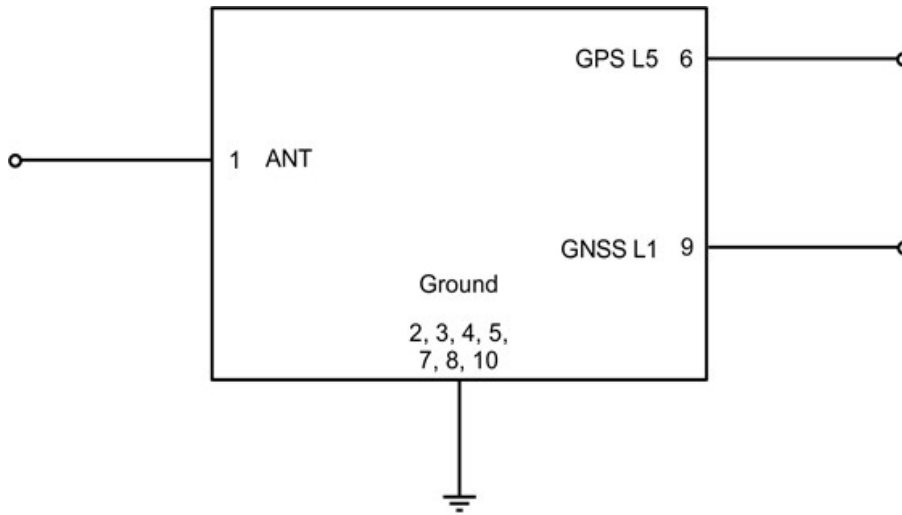

Figure 2: Schematic of matching circuit. No external matching components required.

6 Characteristics ANT – GPS L5

Temperature range for specification	T_{SPEC}	= -30 °C ... +85 °C
ANT terminating impedance	Z_{ANT}	= 50 Ω
GNSS L1 terminating impedance	$Z_{GNSS L1}$	= 50 Ω
GPS L5 terminating impedance	$Z_{GPS L5}$	= 50 Ω

Characteristics ANT – GPS L5				min. for T_{SPEC}	typ. @ +25 °C	max. for T_{SPEC}	
Insertion loss	α	1166.22... 1186.68 MHz		—	1.2	1.5 ¹⁾	dB
		1166.22... 1186.68 MHz		—	1.2	2.2	dB
VSWR		@ ANT port	1166.22... 1186.68 MHz	—	1.4	1.8 ¹⁾	
			1166.22... 1186.68 MHz	—	1.4	2.3	
@ GPS L5 port		1166.22... 1186.68 MHz		—	1.4	1.8 ¹⁾	
		1166.22... 1186.68 MHz		—	1.4	2.3	
Amplitude ripple (p-p)	$\Delta\alpha$	1166.22... 1186.68 MHz		—	0.4	1.5 ¹⁾	dB
		1166.22... 1186.68 MHz		—	0.4	2.0	dB
Attenuation	α	100... 824 MHz		35	45	—	dB
		824... 915 MHz		35	45	—	dB
		825... 960 MHz		35	45	—	dB
		1427... 1463 MHz		32 ²⁾	44 ²⁾	—	dB
		1559... 1606 MHz		20	40	—	dB
		1710... 1785 MHz		35 ²⁾	43 ²⁾	—	dB
		1850... 2025 MHz		35 ²⁾	43 ²⁾	—	dB
		2300... 2690 MHz		30 ²⁾	48 ²⁾	—	dB
		3400... 3800 MHz		25 ²⁾	49 ²⁾	—	dB
		4400... 4900 MHz		24	34	—	dB
5150... 5925 MHz		23	33	—	dB		

¹⁾ Valid for typical temperature $T = +25$ °C.

²⁾ Averaged over any 10 MHz.

7 Characteristics ANT – GNSS L1

Temperature range for specification	T_{SPEC}	= -30 °C ... +85 °C
ANT terminating impedance	Z_{ANT}	= 50 Ω
GNSS L1 terminating impedance	$Z_{GNSS L1}$	= 50 Ω
GPS L5 terminating impedance	$Z_{GPS L5}$	= 50 Ω

Characteristics ANT – GNSS L1				min. for T_{SPEC}	typ. @ +25 °C	max. for T_{SPEC}	
Insertion loss				α			
ANT – BeiDou B1	1559.05... 1563.15	MHz		—	1.5 ³⁾	1.9 ^{1),3)}	dB
	1559.05... 1563.15	MHz		—	1.5 ³⁾	2.3 ³⁾	dB
ANT – GPS L1	1574.39... 1576.45	MHz		—	1.2	1.5 ¹⁾	dB
	1574.39... 1576.45	MHz		—	1.2	1.8	dB
ANT – GLONASS L1	1597.55... 1605.89	MHz		—	1.6 ⁴⁾	2.0 ^{1),4)}	dB
	1597.55... 1605.89	MHz		—	1.6 ⁴⁾	2.4 ^{2),4)}	dB
Group delay ripple (p-p)				Dt			
ANT – GLONASS L1	1597.55... 1605.89	MHz		—	3	15	ns
VSWR							
@ ANT port							
	1559.05... 1563.15	MHz		—	1.5	1.8 ¹⁾	
	1559.05... 1563.15	MHz		—	1.5	2.3	
	1574.39... 1576.45	MHz		—	1.3	1.6 ¹⁾	
	1574.39... 1576.45	MHz		—	1.3	2.0	
	1597.55... 1605.89	MHz		—	1.5	1.7 ¹⁾	
	1597.55... 1605.89	MHz		—	1.5	2.0	
@ GNSS L1 port							
	1559.05... 1563.15	MHz		—	1.5	1.8 ¹⁾	
	1559.05... 1563.15	MHz		—	1.5	2.3	
	1574.39... 1576.45	MHz		—	1.3	1.6 ¹⁾	
	1574.39... 1576.45	MHz		—	1.3	2.0	
	1597.55... 1605.89	MHz		—	1.5	1.7 ¹⁾	
	1597.55... 1605.89	MHz		—	1.5	2.0	
Amplitude ripple (p-p)				$\Delta\alpha$			
ANT – BeiDou B1	1559.05... 1563.15	MHz		—	0.1	1.3 ¹⁾	dB
	1559.05... 1563.15	MHz		—	0.1	1.8	dB
ANT – GPS L1	1574.39... 1576.45	MHz		—	0.1	1.3 ¹⁾	dB
	1574.39... 1576.45	MHz		—	0.1	1.8	dB
ANT – GLONASS L1	1597.55... 1605.89	MHz		—	0.3	1.3 ¹⁾	dB
	1597.55... 1605.89	MHz		—	0.3	1.8	dB
Attenuation				α			
	100... 824	MHz		35	45	—	dB
	824... 915	MHz		35	44	—	dB
	825... 960	MHz		35	44	—	dB
	1166... 1187	MHz		25	43	—	dB
	1427... 1463	MHz		32	40	—	dB

Characteristics ANT – GNSS L1			min. for T_{SPEC}	typ. @ +25 °C	max. for T_{SPEC}	
1710... 1785	MHz		35	44	—	dB
1850... 2025	MHz		37 ⁵⁾	45 ⁵⁾	—	dB
2300... 2690	MHz		32	45	—	dB
3400... 3800	MHz		25	40	—	dB
4400... 4900	MHz		25	37	—	dB
5150... 5925	MHz		25	40	—	dB

- 1) Valid for typical temperature $T = +25\text{ °C}$.
- 2) Valid for temperature $T = -30\text{ °C}...+60\text{ °C}$.
- 3) Averaged over any 4.092 MHz.
- 4) Averaged over any 1.022 MHz.
- 5) Averaged over any 10 MHz.

8 Maximum ratings

Storage temperature	$T_{STG}^{2)} = -40\text{ °C} \dots +85\text{ °C}^{1)}$	
DC voltage	$ V_{DC} = 5.0\text{ V (max.)}^{3)}$	
ESD voltage		
	$V_{ESD}^{4)} = 225\text{ V (max.)}$	Machine model.
	$V_{ESD}^{5)} = 400\text{ V (max.)}$	Human body model.
	$V_{ESD}^{6)} = 700\text{ V (max.)}$	Charged device model.
Input power	P_{IN}	
@ ANT port: 1166.22 ... 1186.68 MHz	10 dBm	Continuous wave for 3000 h @ 50 °C.
@ ANT port: 1559.05 ... 1605.89 MHz	10 dBm	Continuous wave for 3000 h @ 50 °C.

¹⁾ Extended upper limit: 96h@125°C acc. to IEC 60068-2-2-Bb.

²⁾ Not valid for packaging material. Storage temperature for packaging material is -25 °C to +40 °C.

³⁾ 168h Damp Heat Steady State acc. to IEC 60068-2-67 Cy.

⁴⁾ According to JESD22-A115B (MM – Machine Model), 10 negative & 10 positive pulses.

⁵⁾ According to JESD22-A114F (HBM – Human Body Model), 1 negative & 1 positive pulse.

⁶⁾ According to JESD22-C101C (CDM – Field Induced Charged Device Model), 3 negative & 3 positive pulses.

9 Transmission coefficient ANT – GPS L5

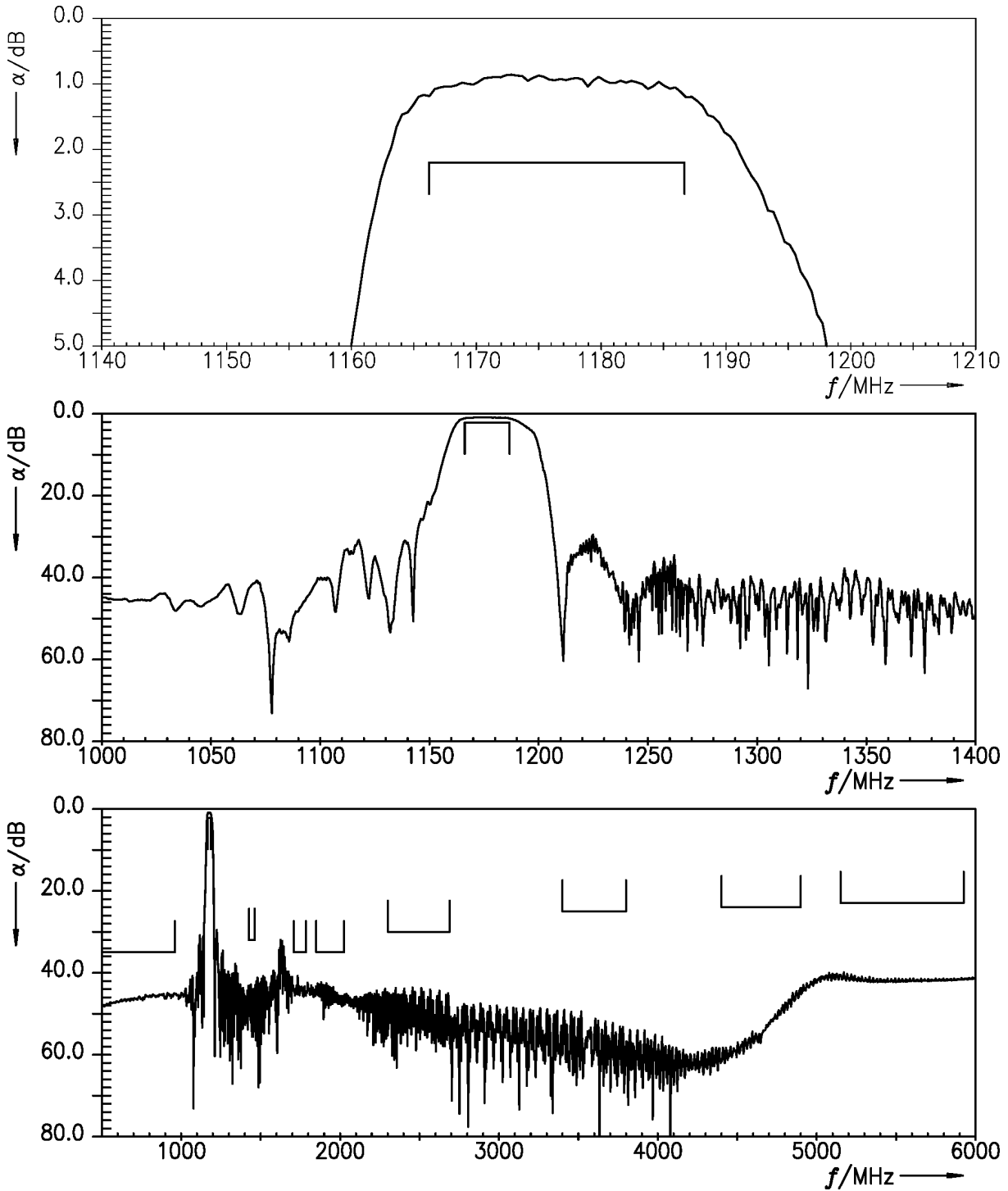

Figure 3: Attenuation ANT – GPS L5.

10 Reflection coefficients ANT – GPS L5

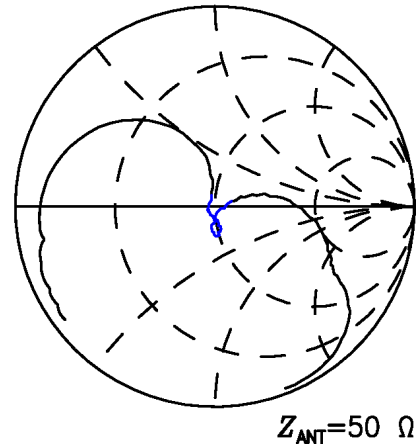
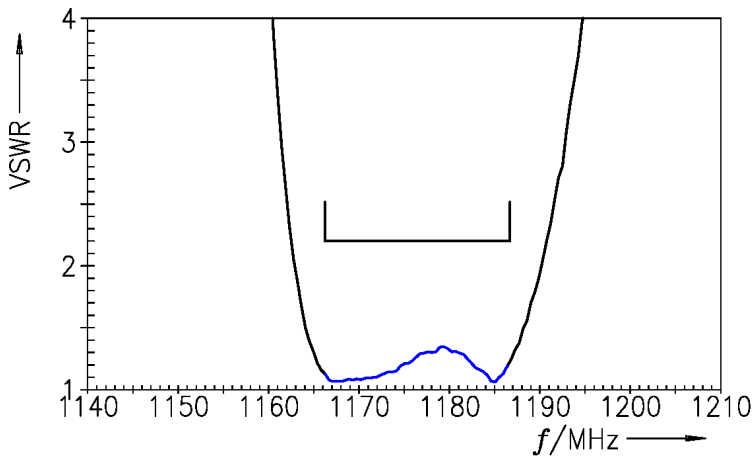

Figure 4: Reflection coefficient at ANT port.

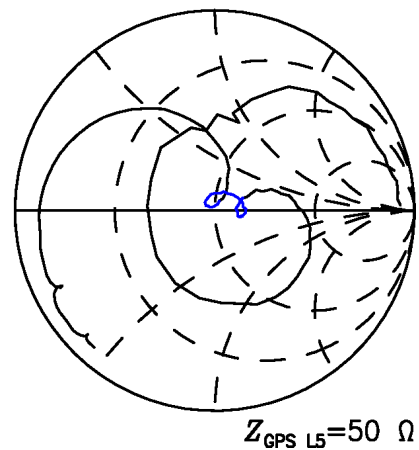
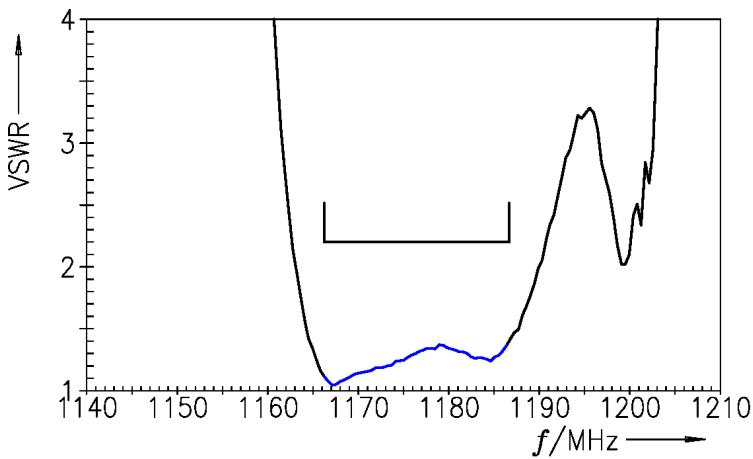

Figure 5: Reflection coefficient at GPS L5 port.

11 Transmission coefficient ANT – GNSS L1

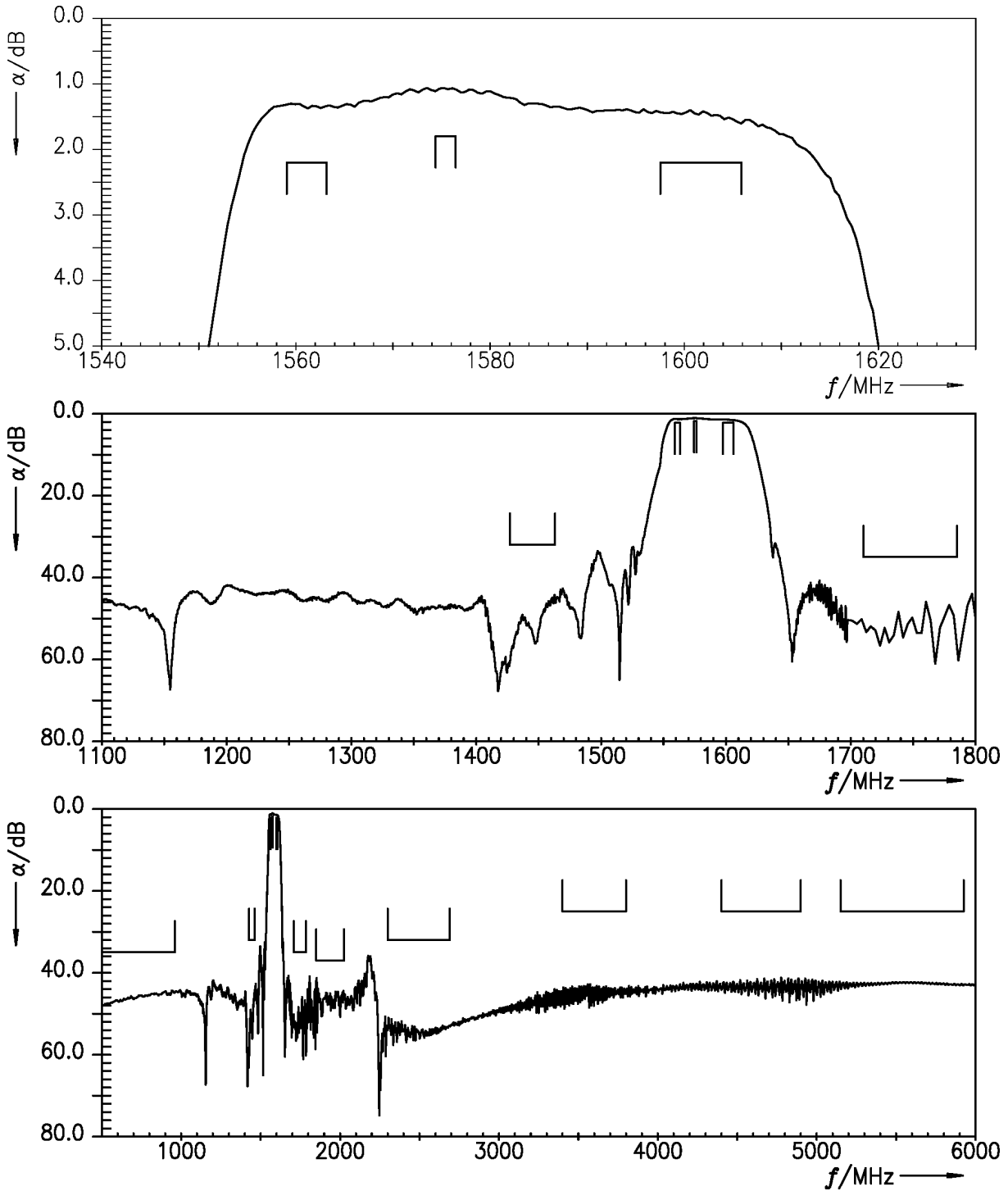

Figure 6: Attenuation ANT – GNSS L1.

12 Reflection coefficients ANT – GNSS L1

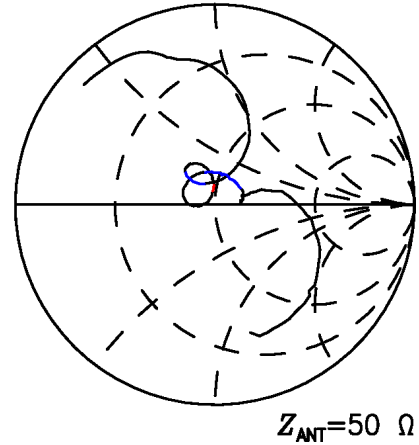
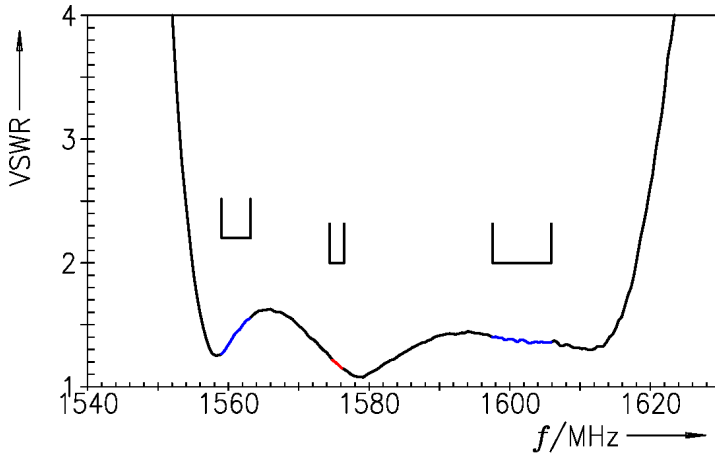

Figure 7: Reflection coefficient at ANT port.

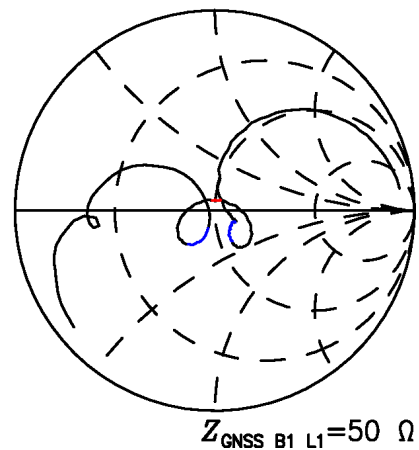
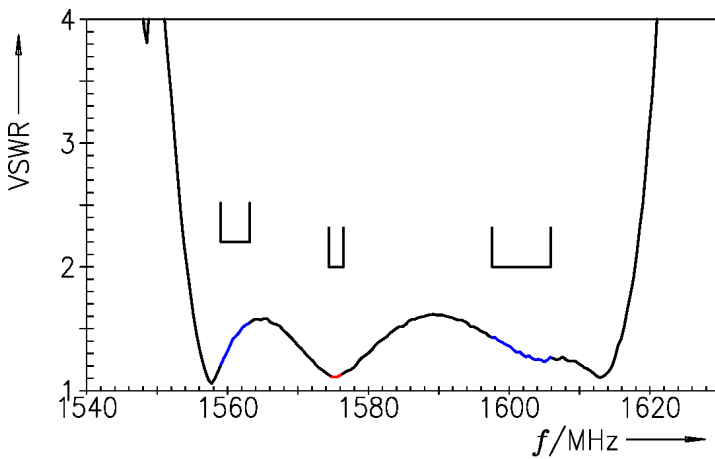

Figure 8: Reflection coefficient at GNSS L1 port.

13 Packing material

13.1 Tape

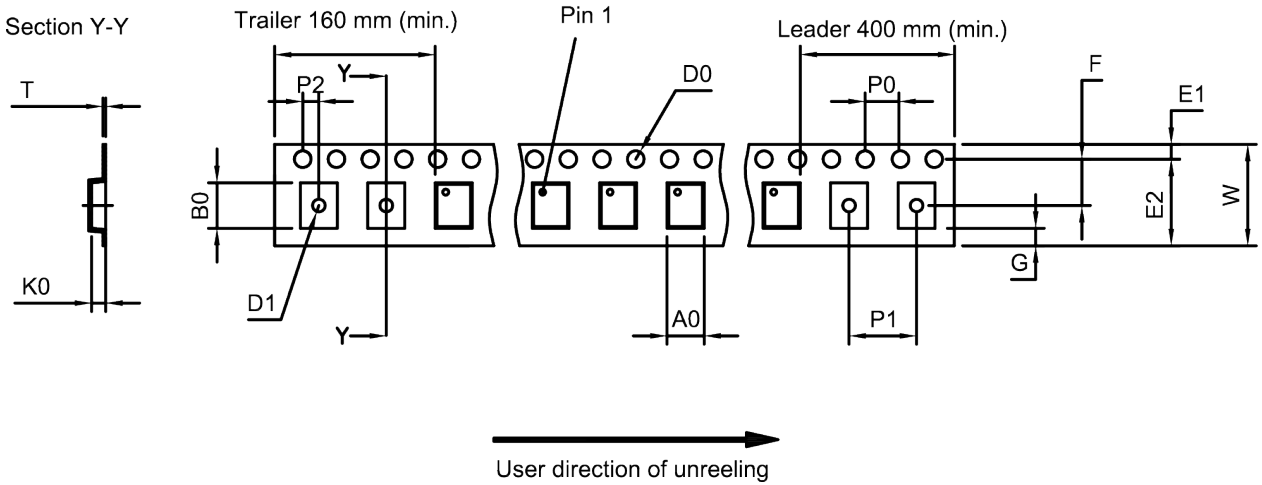

Figure 9: Drawing of tape (first-angle projection) for illustration only and not to scale. The valid tape dimensions are listed in Table 1.

A ₀	1.35±0.05 mm	E ₂	6.25 mm (min.)	P ₁	4.0±0.1 mm
B ₀	1.75±0.05 mm	F	3.5±0.05 mm	P ₂	2.0±0.05 mm
D ₀	1.5+0.1/-0 mm	G	0.75 mm (min.)	T	0.25±0.03 mm
D ₁	0.8 mm (min.)	K ₀	0.76±0.05 mm	W	8.0+0.3/-0.1 mm
E ₁	1.75±0.1 mm	P ₀	4.0±0.1 mm		

Table 1: Tape dimensions.

13.2 Reel with diameter of 180 mm

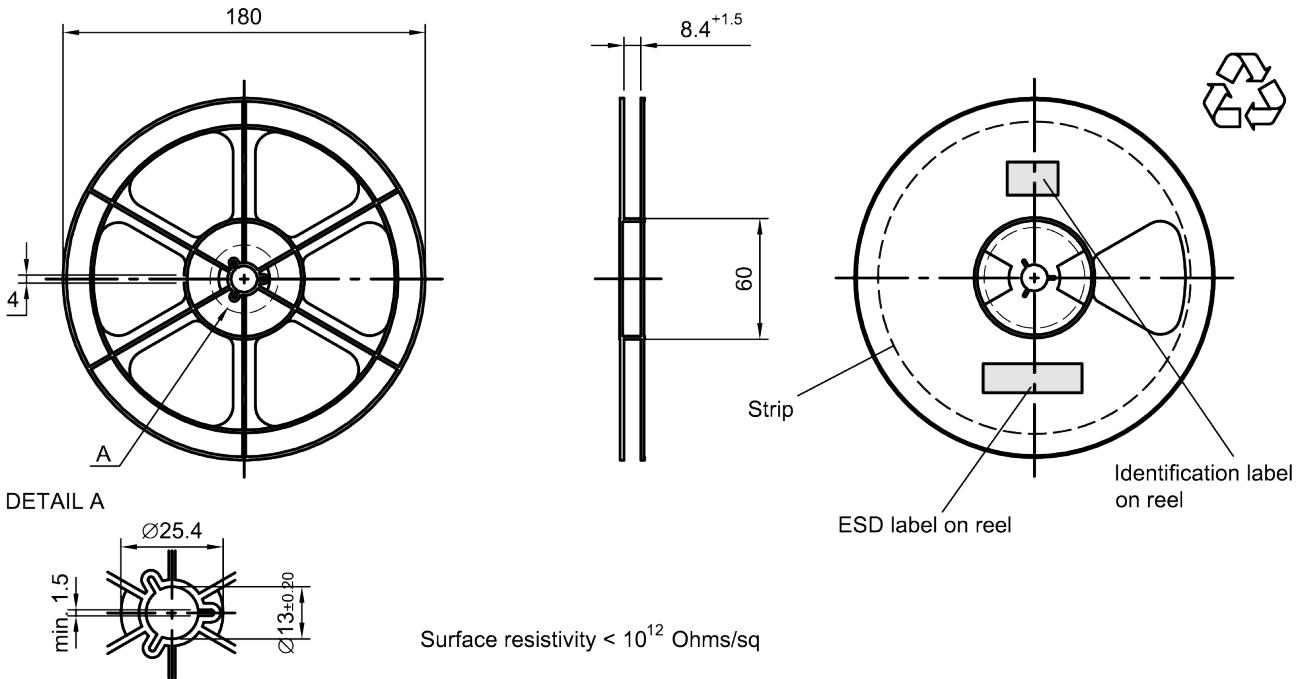

Figure 10: Drawing of reel (first-angle projection) with diameter of 180 mm.

Dimensions [mm]

X = 220+5

Y = 235+5

Sealing area 10±3

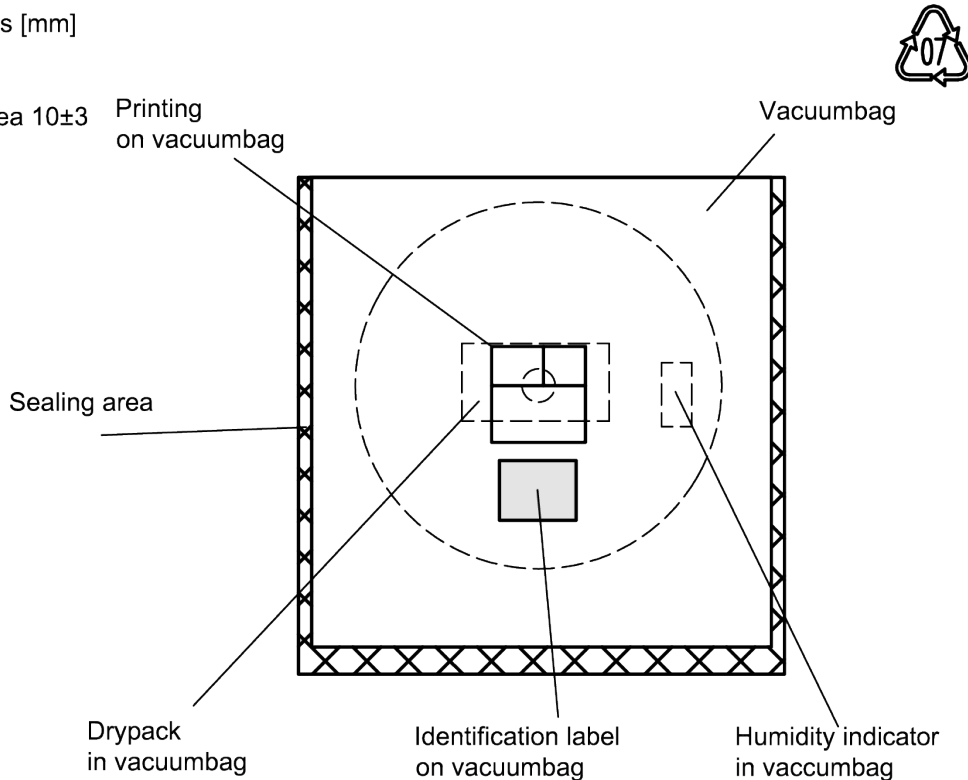

Figure 11: Drawing of moisture barrier bag (MBB) for reel with diameter of 180 mm.

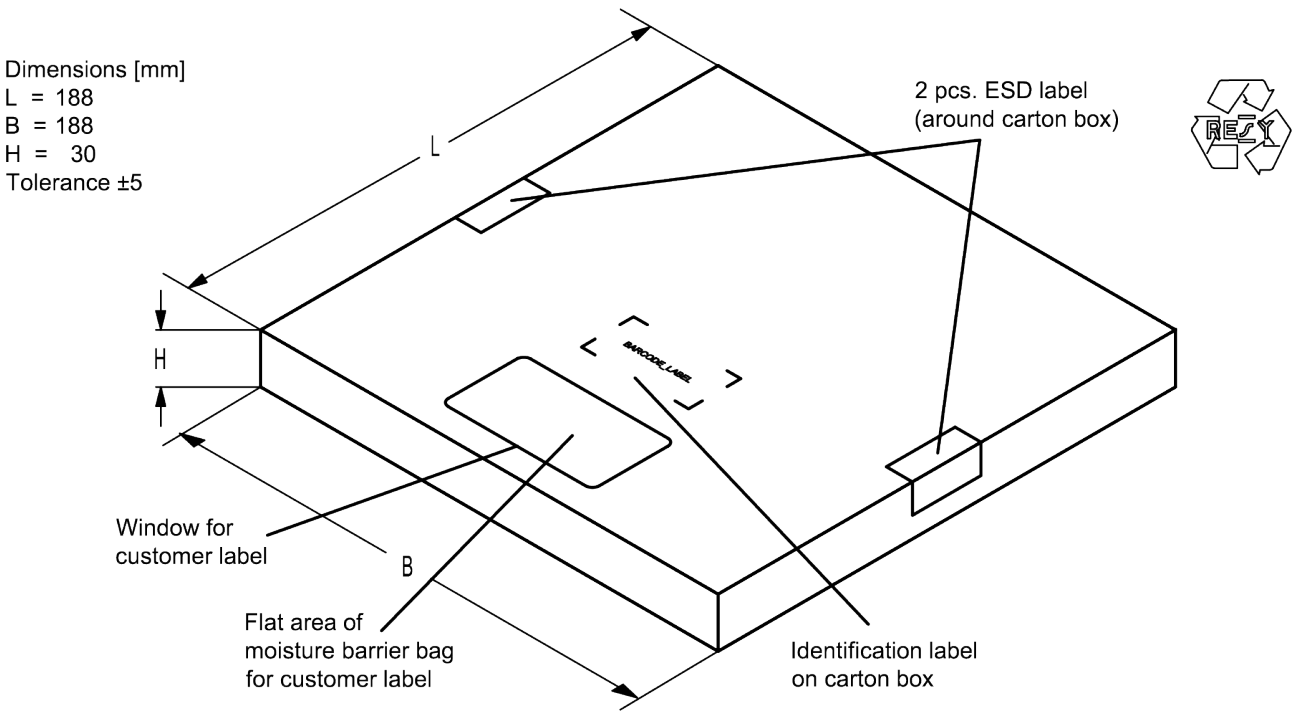

Figure 12: Drawing of folding box for reel with diameter of 180 mm.

13.3 Reel with diameter of 330 mm

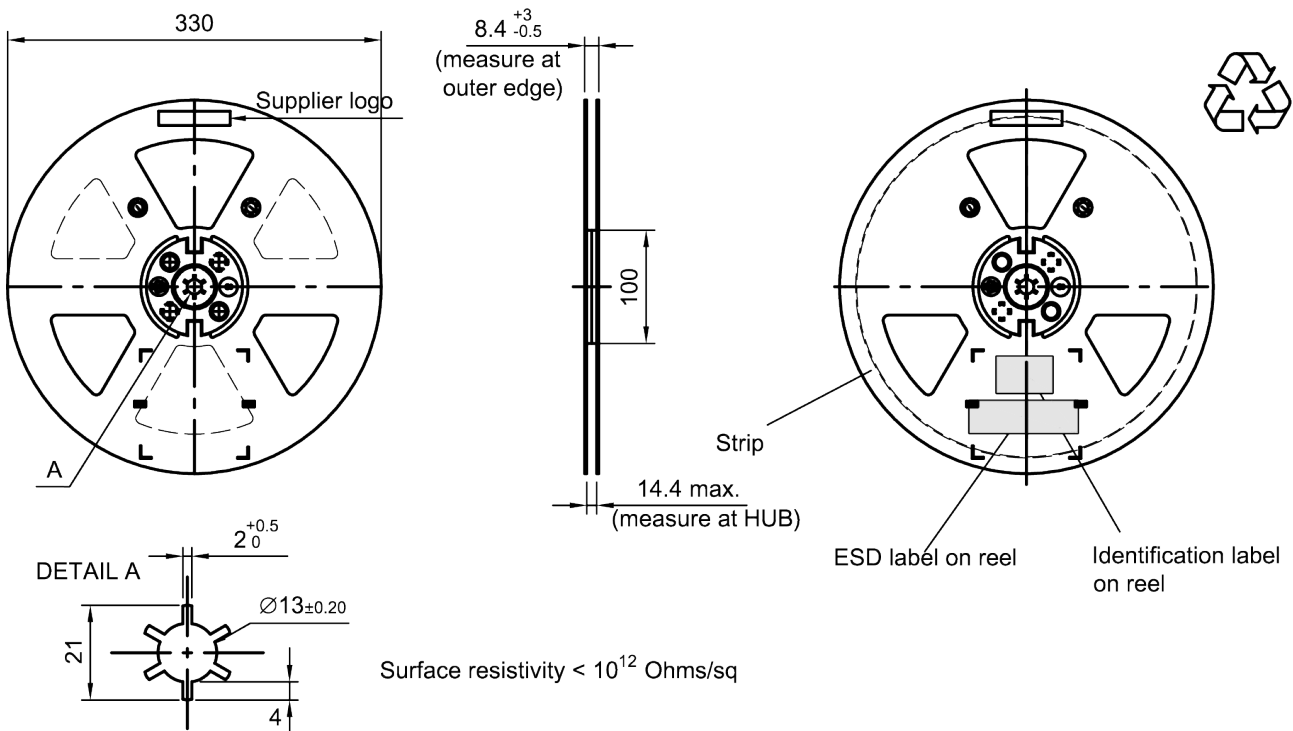

Figure 13: Drawing of reel (first-angle projection) with diameter of 330 mm.

Dimensions [mm]

X = 400+5

Y = 418+5

Sealing area 10±3

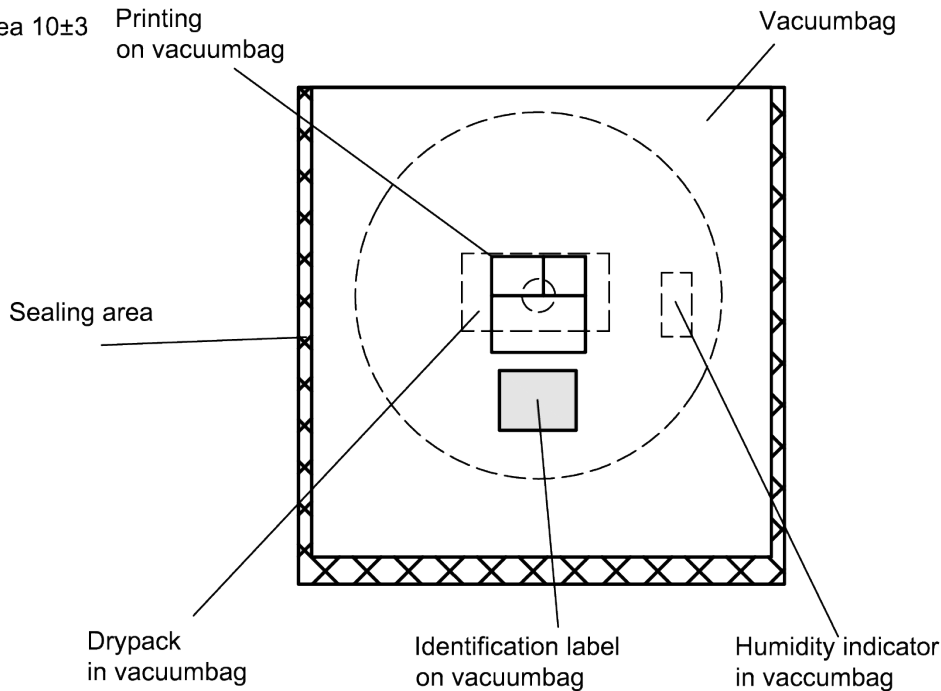

Figure 14: Drawing of moisture barrier bag (MBB) for reel with diameter of 330 mm.

Dimensions [mm]

L = 335

B = 338

H = 36 (for 8 mm tape width)

40 (for 12 mm tape width)

Tolerance ±5

2 pcs. ESD label
(around carton box)

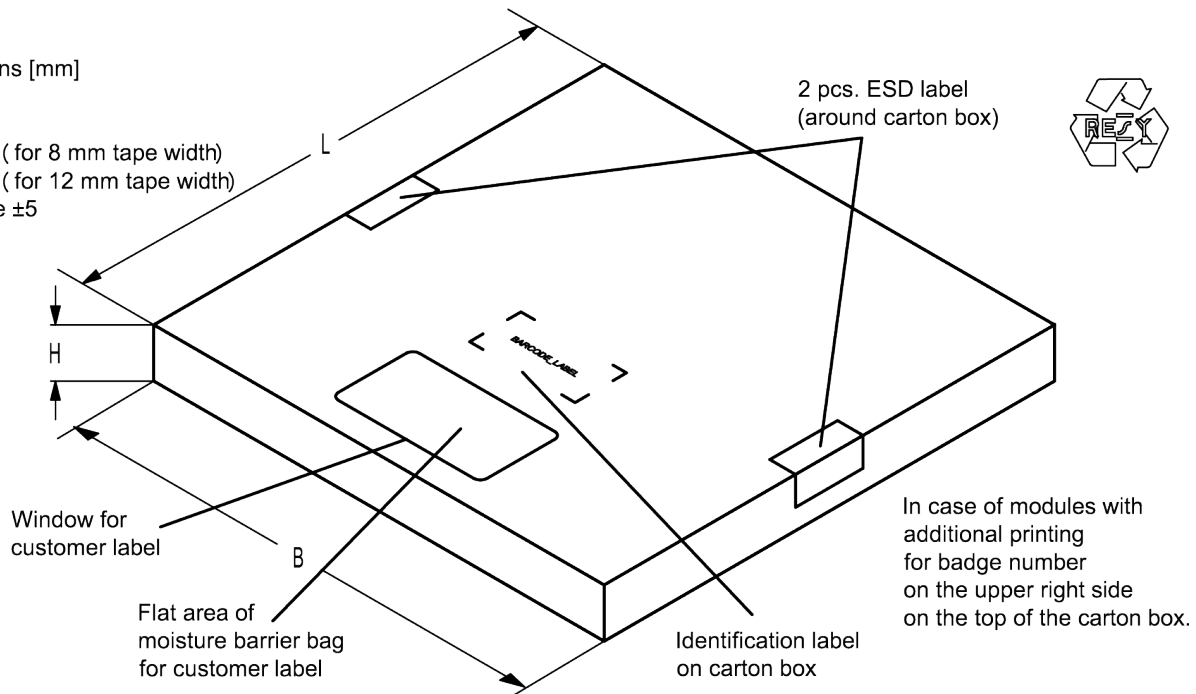

Figure 15: Drawing of folding box for reel with diameter of 330 mm.

14 Marking

Products are marked with product type number and lot number encoded according to Table 2:

■ Type number:

The 4 digit type number of the ordering code, e.g., B3xxxxB**1234**xxxx,
is encoded by a special BASE32 code into a 3 digit marking.

Example of decoding type number marking on device in decimal code.
16J => **1234**
 $1 \times 32^2 + 6 \times 32^1 + 18 (=J) \times 32^0 =$ **1234**
 The BASE32 code for product type B1267 is 17K.

■ Lot number:

The last 5 digits of the lot number, e.g., **12345**,
are encoded based on a special BASE47 code into a 3 digit marking.

Example of decoding lot number marking on device in decimal code.
5UY => **12345**
 $5 \times 47^2 + 27 (=U) \times 47^1 + 31 (=Y) \times 47^0 =$ **12345**

Adopted BASE32 code for type number			
Decimal value	Base32 code	Decimal value	Base32 code
0	0	16	G
1	1	17	H
2	2	18	J
3	3	19	K
4	4	20	M
5	5	21	N
6	6	22	P
7	7	23	Q
8	8	24	R
9	9	25	S
10	A	26	T
11	B	27	V
12	C	28	W
13	D	29	X
14	E	30	Y
15	F	31	Z

Adopted BASE47 code for lot number			
Decimal value	Base47 code	Decimal value	Base47 code
0	0	24	R
1	1	25	S
2	2	26	T
3	3	27	U
4	4	28	V
5	5	29	W
6	6	30	X
7	7	31	Y
8	8	32	Z
9	9	33	b
10	A	34	d
11	B	35	f
12	C	36	h
13	D	37	n
14	E	38	r
15	F	39	t
16	G	40	v
17	H	41	\
18	J	42	?
19	K	43	{
20	L	44	}
21	M	45	<
22	N	46	>
23	P		

Table 2: Lists for encoding and decoding of marking.

15 Soldering profile

The recommended soldering process is in accordance with IEC 60068-2-58 – 3rd edit and IPC/JEDEC J-STD-020B.

ramp rate	≤ 3 K/s
preheat	125 °C to 220 °C, 150 s to 210 s, 0.4 K/s to 1.0 K/s
T > 220 °C	30 s to 70 s
T > 230 °C	min. 10 s
T > 245 °C	max. 20 s
T ≥ 255 °C	–
peak temperature T_{peak}	250 °C +0/-5 °C
wetting temperature T_{min}	230 °C +5/-0 °C for 10 s ± 1 s
cooling rate	≤ 3 K/s
soldering temperature T	measured at solder pads

Table 3: Characteristics of recommended soldering profile for lead-free solder (Sn95.5Ag3.8Cu0.7).

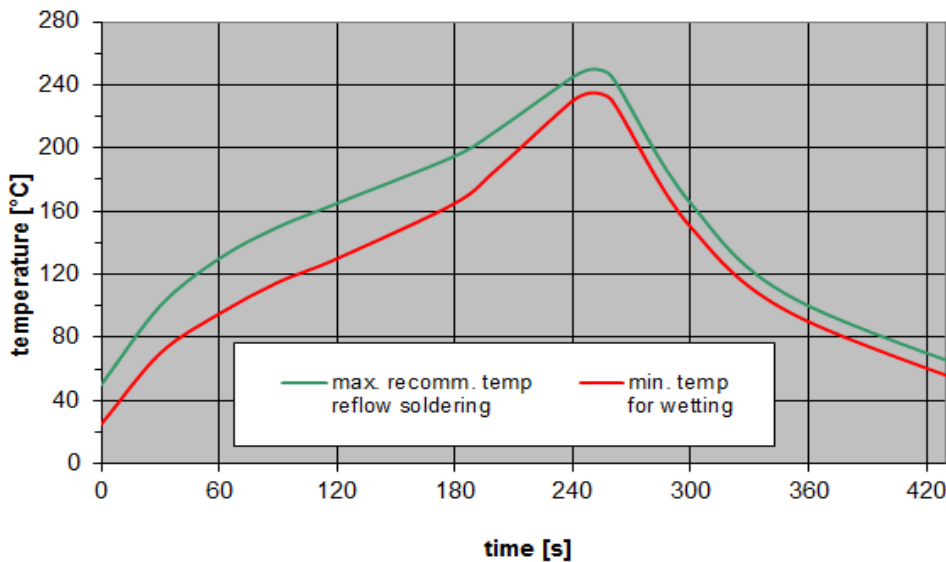

Figure 16: Recommended reflow profile for convection and infrared soldering – lead-free solder.

16 Annotations

16.1 RoHS compatibility

ROHS-compatible means that products are compatible with the requirements according to Art. 4 (substance restrictions) of Directive 2011/65/EU of the European Parliament and of the Council of June 8th, 2011, on the restriction of the use of certain hazardous substances in electrical and electronic equipment ("Directive") with due regard to the application of exemptions as per Annex III of the Directive in certain cases.

16.2 Scattering parameters (S-parameters)

The pin/port assignment is available in the headers of the S-parameter files. Please contact your local RF360 sales office.

16.3 Ordering codes and packing units

Ordering code	Packing unit
B39162B1267L210	15,000 pcs
B39162B1267L210S 5	5,000 pcs

Table 4: Ordering codes and packing units.

17 Cautions and warnings

17.1 Display of ordering codes for RF360 products

The ordering code for one and the same product can be represented differently in data sheets, data books, other publications and the website of RF360, or in order-related documents such as shipping notes, order confirmations and product labels. The varying representations of the ordering codes are due to different processes employed and do not affect the specifications of the respective products. Detailed information can be found on the Internet under <https://rfe.qualcomm.com/>.

17.2 Material information

Due to technical requirements components may contain dangerous substances. For information on the type in question please also contact one of our sales offices.

For information on recycling of tapes and reels please contact one of our sales offices.

17.3 Moldability

Before using in overmolding environment, please contact your local RF360 sales office.

17.4 Package information

Landing area

The printed circuit board (PCB) land pattern (landing area) shown is based on RF360 internal development and empirical data and illustrated for example purposes, only. As customers' SMD assembly processes may have a plenty of variants and influence factors which are not under control or knowledge of RF360, additional careful process development on customer side is necessary and strongly recommended in order to achieve best soldering results tailored to the particular customer needs.

Dimensions

Unless otherwise specified all dimensions are understood using unit millimeter (mm).

Projection method

Unless otherwise specified first-angle projection is applied.

18 Important notes

The following applies to all products named in this publication:

1. Some parts of this publication contain **statements about the suitability of our products for certain areas of application**. These statements are based on our knowledge of typical requirements that are often placed on our products in the areas of application concerned. We nevertheless expressly point out **that such statements cannot be regarded as binding statements about the suitability of our products for a particular customer application**. As a rule, RF360 Europe GmbH and its affiliates are either unfamiliar with individual customer applications or less familiar with them than the customers themselves. For these reasons, it is always ultimately incumbent on the customer to check and decide whether an RF360 product with the properties described in the product specification is suitable for use in a particular customer application.
2. We also point out that **in individual cases, a malfunction of electronic components or failure before the end of their usual service life cannot be completely ruled out in the current state of the art, even if they are operated as specified**. In customer applications requiring a very high level of operational safety and especially in customer applications in which the malfunction or failure of an electronic component could endanger human life or health (e.g. in accident prevention or life-saving systems), it must therefore be ensured by means of suitable design of the customer application or other action taken by the customer (e.g. installation of protective circuitry or redundancy) that no injury or damage is sustained by third parties in the event of malfunction or failure of an electronic component.
3. **The warnings, cautions and product-specific notes must be observed.**
4. In order to satisfy certain technical requirements, **some of the products described in this publication may contain substances subject to restrictions in certain jurisdictions (e.g. because they are classed as hazardous)**. Useful information on this will be found in our Material Data Sheets on the Internet (<https://rfe.qualcomm.com>). Should you have any more detailed questions, please contact our sales offices.
5. We constantly strive to improve our products. Consequently, **the products described in this publication may change from time to time**. The same is true of the corresponding product specifications. Please check therefore to what extent product descriptions and specifications contained in this publication are still applicable before or when you place an order. We also **reserve the right to discontinue production and delivery of products**. Consequently, we cannot guarantee that all products named in this publication will always be available.
The aforementioned does not apply in the case of individual agreements deviating from the foregoing for customer-specific products.

单击下面可查看定价，库存，交付和生命周期等信息

[>>Qualcomm-RF360](#)