

■ PRODUCT CLASSIFICATION

1) Ordering information

XC9276①②③④⑤⑥⑦

DESIGNATOR	ITEM	SYMBOL	DESCRIPTION
①	Product Type	B	Without C _L Discharge
		D	With C _L Discharge
②③④ (*2)	Output Voltage	Refer to the table	Output Voltage combination V _{OUT1} : 0.50V ~ 3.60V V _{OUT2} : 0.50V ~ 3.60V (V _{OUT1,2} ≤ 1.9V : 0.05V increments, V _{OUT1,2} > 1.9V : 0.1V increments)
⑤⑥⑦ (*1)	Packages (Order Unit)	0R-G	WLP-6-03 (5,000pcs/Reel)
		MR-G	SOT-26W (3,000pcs/Reel)
		ER-G	USP-8B06 (5,000pcs/Reel)

(*1) The "-G" suffix denotes Halogen and Antimony free as well as being fully EU RoHS compliant.

(*2) V_{OUT1} < V_{OUT2} is our standard specification.

With regard to other voltage options, please contact our sales representative.

● Symbols ②, ③, ④ : Output voltage combination example

②③④	V _{OUT2} (V)	V _{OUT1} (V)																	
		0.50	0.60	0.65	0.70	0.80	0.90	1.00	1.10	1.20	1.30	1.50	1.80	1.85	2.00	2.20	2.50	3.00	3.30
②③④	0.50	-	-	R04	-	-	-	-	-	-	-	-	-	-	-	-	-	-	-
	0.60	N02	-	-	-	-	-	-	-	-	-	-	-	-	-	-	-	-	-
	0.65	N03	001	-	-	-	-	-	-	-	-	-	-	-	-	-	-	-	-
	0.70	N04	002	061	-	-	-	-	-	-	-	-	-	-	-	-	-	-	-
	0.80	N06	004	063	121	-	-	-	-	-	-	-	-	-	-	-	-	-	-
	0.90	N08	006	065	123	236	-	-	-	-	-	-	-	-	-	-	-	-	-
	1.00	N10	008	067	125	238	347	-	-	-	-	-	-	-	-	-	-	-	-
	1.10	N12	010	069	127	240	349	454	-	-	-	-	-	-	-	-	-	-	-
	1.20	N14	012	071	129	242	351	456	557	-	-	-	-	-	-	-	-	-	-
	1.30	N16	014	073	131	244	353	458	559	656	-	-	-	-	-	-	-	-	-
	1.50	N20	018	077	135	248	357	462	563	660	753	-	-	-	-	-	-	-	-
	1.80	N26	024	083	141	254	363	468	569	666	759	933	-	-	-	-	-	-	-
	1.85	N27	025	084	142	255	364	469	570	667	760	934	B67	-	-	-	-	-	-
	2.00	N30	028	087	145	258	367	472	573	670	763	937	B70	C06	-	-	-	-	-
	2.20	N34	032	091	149	262	371	476	577	674	767	941	B74	C10	D10	-	-	-	-
	2.50	N40	038	097	155	268	377	482	583	680	773	947	B80	C16	D16	E35	-	-	-
3.00	N50	048	107	165	278	387	492	593	690	783	957	B90	C26	D26	E45	F93	-	-	
3.30	N56	054	113	171	284	393	498	599	696	789	963	B96	C32	D32	E51	F99	K66	-	
3.60	N62	060	119	177	290	399	504	605	702	795	969	C03	C38	D38	E57	H06	K72	M24	

With regard to other voltage, please contact our sales representative.

2) Selection Guide

FUNCTION	B TYPE		D TYPE	
	V _{OUT1} or V _{OUT2} < 1.2V	V _{OUT1,2} ≥ 1.2V	V _{OUT1} or V _{OUT2} < 1.2V	V _{OUT1,2} ≥ 1.2V
Output Voltage	Output voltage selectable by VSET pin			
Short Protection	-	Yes	-	Yes
C _L Discharge	-		Yes	
Chip Enable	Yes			
UVLO	Yes			

PIN CONFIGURATION

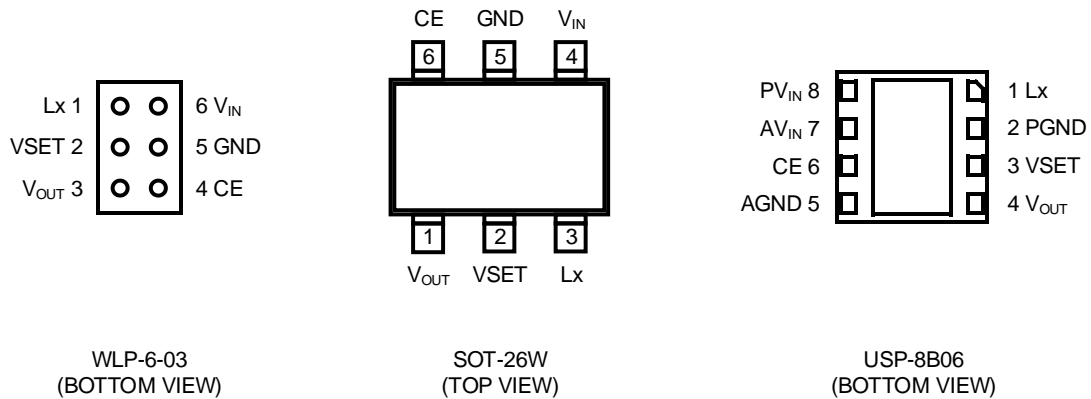

* The dissipation pad should be solder-plated in recommended mount pattern and metal masking to enhance mounting strength and heat release. If the pad needs to be connected to other pins, it should be connected to the PGND (No.2) pin and the AGND (No. 5) pin.

PIN ASSIGNMENT

PIN NUMBER			PIN NAME	FUNCTION
WLP-6-03	SOT-26W	USP-8B06		
1	3	1	Lx	Switching
2	2	3	VSET	Output Voltage control
3	1	4	V _{OUT}	Output Voltage
4	6	6	CE	Chip Enable
5	5	-	GND	Ground
6	4	-	V _{IN}	Input Voltage
-	-	2	PGND	Power Ground
-	-	5	AGND	Analog Ground
-	-	7	AV _{IN}	Analog Input
-	-	8	PV _{IN}	Power Input

FUNCTION

PIN NAME	SIGNAL	STATUS
CE	H	Active
	L	Stand-by

* Please do not leave the CE pin open.

PIN NAME	SIGNAL	STATUS
VSET	H	V _{OUT2}
	L	V _{OUT1}

* Please do not leave the VSET pin open.

■ ABSOLUTE MAXIMUM RATINGS

PARAMETER		SYMBOL	RATINGS	UNITS
V _{IN} Pin Voltage		V _{IN}	-0.3 ~ 7.0	V
Lx Pin Voltage		V _{LX}	-0.3 ~ V _{IN} + 0.3 or 7.0 ^(*)	V
V _{OUT} Pin Voltage		V _{OUT}	-0.3 ~ V _{IN} + 0.3 or 7.0 ^(*)	V
CE Pin Voltage		V _{CE}	-0.3 ~ 7.0	V
VSET Pin Voltage		VSET	-0.3 ~ 7.0	V
Power Dissipation (T _a =25°C)	WLP-6-03	P _d	840 (JESD51-7 board) ^(**)	mW
	SOT-26W		820 (JESD51-7 board) ^(**)	
	USP-8B06		1240 (JESD51-7 board) ^(**)	
Operating Ambient Temperature		T _{opr}	-40 ~ 85	°C
Storage Temperature		T _{stg}	-55 ~ 125	°C

* All voltages are described based on the GND pin. For USP-8B06, AV_{IN} and PV_{IN} must be shorted and handled as V_{IN}.

^(*) The maximum value should be either V_{IN}+0.3V or 7.0V in the lowest.

^(**) The power dissipation figure shown is PCB mounted and is for reference only.

The mounting condition is please refer to PACKAGING INFORMATION.

ELECTRICAL CHARACTERISTICS

Ta=25°C

PARAMETER	SYMBOL	CONDITIONS	MIN.	TYP.	MAX.	UNITS	CIRCUIT	
Output Voltage1 ⁽¹⁾	V _{OUT1}	When connected to external components, VSET = 0.0V, I _{OUT} = 30mA	-	<T-1>	-	V	①	
Output Voltage1-2	V _{OUT1-2}	VSET = 0.0V, Voltage which L _x pin changes "H" to "L" level while V _{OUT} is increase. ⁽⁶⁾	<E-1>	<E-2>	<E-3>	V	②	
Output Voltage2 ⁽¹⁾	V _{OUT2}	When connected to external components, VSET = V _{IN} , I _{OUT} = 30mA	-	<T-1>	-	V	①	
Output Voltage2-2	V _{OUT2-2}	VSET = V _{IN} , Voltage which L _x pin changes "H" to "L" level while V _{OUT} is increase. ⁽⁶⁾	<E-1>	<E-2>	<E-3>	V	②	
Operating Voltage Range	V _{IN}	-	1.8	-	6.0	V	①	
Maximum Output Current	I _{OUTMAX}	When connected to external components ⁽²⁾	150	-	-	mA	①	
UVLO Release Voltage	V _{UVLOR}	V _{OUT} = 0.0V, V _{CE} = VSET = 1.8V Voltage which L _x pin holding "H" level ⁽⁶⁾	Ta=25°C	-	1.50	1.78	V	②
			Ta=-40~85°C ⁽³⁾					
UVLO Detect Voltage	V _{UVLOD}	V _{OUT} = 0.0V, V _{CE} = VSET = 1.8V Voltage which L _x pin holding "L" level ⁽⁶⁾	Ta=25°C	1.00	1.40	-	V	②
			Ta=-40~85°C ⁽³⁾					
Quiescent Current	I _q	V _{IN} = V _{CE} = <C-1>, VSET = 0.0V, V _{OUT} = V _{OUT1} × 1.05	-	<E-4>	<E-5>	nA	③	
Stand-by Current	I _{STB}	V _{IN} = 6.0V, V _{CE} = V _{OUT} = 0.0V	-	0.0	0.1	μA	③	
PFM Switching Current	I _{PFM}	When connected to external components, V _{IN} = V _{OUT(T)} + 2.0V, I _{OUT} = 10mA	-	400	600	mA	①	
Efficiency	EFFI	I _{OUT} = 30mA	-	<E-6>	-	%	①	
Lx SW "H" ON Resistance ⁽⁴⁾	R _{LXH}	V _{OUT} = 0.0V, V _{IN} = V _{CE} = VSET = 5.0V, I _{LX} = 50mA	-	0.35	0.45	Ω	④	
Lx SW "L" ON Resistance ⁽³⁾	R _{LXL}	V _{IN} = 5.0V	-	0.32	0.42	Ω	-	
Lx SW "H" Leakage Current	I _{LeakH}	V _{IN} = 6.0V, V _{OUT} = V _{CE} = VSET = 0.0V, V _{LX} = 6.0V	-	0.0	0.1	μA	④	
Lx SW "L" Leakage Current	I _{LeakL}	V _{IN} = 6.0V, V _{OUT} = V _{CE} = VSET = 0.0V, V _{LX} = 0.0V	-	0.0	0.1	μA	④	
Output Voltage Temperature Characteristics	$\frac{\Delta V_{OUT}}{V_{OUT}}$ (V _{OUT} = V _{OUT1}) $\frac{\Delta T_{opr}}{T_{opr}}$	I _{OUT} = 30mA -40°C ≤ T _{opr} ≤ 85°C	-	±100	-	ppm/°C	①	

Unless otherwise stated, V_{IN}=5V, V_{CE}=5V, V_{OUT(T)}=Nominal Value

(*1) V_{OUT1} and V_{OUT2} are the average values of the output voltage considering the ripple voltage and they are set so that they can be a setting output voltage with this evaluation condition.

(*2) The maximum output current performance varies based on a voltage difference between an input voltage and an output voltage, and external components and so on. Regarding detail of this variation, please refer to OPERATIONAL EXPLANATION and NOTE ON USE section.

(*3) Design value

(*4) Design value for WLP-6-03

(*5) SHORT PROTECTION with LATCH is not available if V_{OUT1} is 1.2V or less.

(*6) "H" = V_{IN} ~ V_{IN} -1.2V, "L" = 0.1V ~ -0.1V

■ ELECTRICAL CHARACTERISTICS

Ta=25°C

PARAMETER	SYMBOL	CONDITIONS	MIN.	TYP.	MAX.	UNITS	CIRCUIT	
CE "H" Voltage	V _{CEH}	VSET = V _{IN} , V _{OUT} = 0.0V, Voltage which Lx pin holding "H" level ^(*6)	Ta=25°C	1.2	-	6.0	V	②
			Ta=-40~85°C ^(*3)					
CE "L" Voltage	V _{CEL}	VSET = V _{IN} , V _{OUT} = 0.0V, Voltage which Lx pin holding "L" level ^(*6)	Ta=25°C	GND	-	0.3	V	②
			Ta=-40~85°C ^(*3)					
CE "H" Current	I _{CEH}	V _{IN} = 6.0V, V _{OUT} = 0.0V, V _{CE} = 6.0V, VSET = 6.0V	-0.1	0.0	0.1	μA	④	
CE "L" Current	I _{CEL}	V _{IN} = 6.0V, V _{OUT} = 0.0V, V _{CE} = 0.0V, VSET = 6.0V	-0.1	0.0	0.1	μA	④	
VSET "H" Voltage	VSET _H	V _{OUT} = (V _{OUT1} + V _{OUT2}) / 2 , V _{OUT1} < V _{OUT2} →Voltage which Lx pin holding "H" level ^(*6) V _{OUT1} > V _{OUT2} →Voltage which Lx pin holding "L" level ^(*6)	Ta=25°C	1.2	-	6.0	V	②
			Ta=-40~85°C ^(*3)					
VSET "L" Voltage	VSET _L	V _{OUT} = (V _{OUT1} + V _{OUT2}) / 2 , V _{OUT1} < V _{OUT2} →Voltage which Lx pin holding "L" level ^(*6) V _{OUT1} > V _{OUT2} →Voltage which Lx pin holding "H" level ^(*6)	Ta=25°C	GND	-	0.3	V	②
			Ta=-40~85°C ^(*3)					
VSET "H" Current	I _{VSETH}	V _{IN} = 6.0V, V _{OUT} = 0.0V, V _{CE} = 6.0V, VSET = 6.0V	-0.1	0.0	0.1	μA	④	
VSET "L" Current	I _{VSETL}	V _{IN} = 6.0V, V _{OUT} = 0.0V, V _{CE} = 6.0V, VSET = 0.0V	-0.1	0.0	0.1	μA	④	
Short Protection Threshold Voltage ^(*5)	V _{SHORT}	VSET = 5.0V, Voltage which Lx pin holding "L" level ^(*6)	Ta=25°C	0.10	0.54	0.80	V	②
			Ta=-40~85°C ^(*3)					
C _L Discharge (Type D)	R _{DCHG}	V _{IN} = 5.0V, V _{CE} = 0.0V, V _{OUT} = 0.1V, VSET = 5.0V	29	45	60	Ω	②	

Unless otherwise stated, V_{IN}=5V, V_{CE}=5V, V_{OUT(T)}=Nominal Value

(*1) V_{OUT1} and V_{OUT2} are the average values of the output voltage considering the ripple voltage and they are set so that they can be a setting output voltage with this evaluation condition.

(*2) The maximum output current performance varies based on a voltage difference between an input voltage and an output voltage, and external components and so on. Regarding detail of this variation, please refer to OPERATIONAL EXPLANATION and NOTE ON USE section.

(*3) Design value

(*4) Design value for WLP-5-06

(*5) SHORT PROTECTION with LATCH is not available if V_{OUT1} is 1.2V or less.

(*6) "H" = V_{IN} ~ V_{IN} - 1.2V, "L" = 0.1V ~ -0.1V

ELECTRICAL CHARACTERISTICS

SPEC Table

Nominal Output Voltage $V_{OUT(T)}$	$V_{OUT1}, V_{OUT1-2}, V_{OUT2}, V_{OUT2-2}, (V)$				$V_{IN} (V)$	$I_q (nA)$		EFFI (%)
	<T-1>	<E-1>	<E-2>	<E-3>	<C-1>	<E-4>	<E-5>	<E-6>
	TYP.	MIN.	TYP.	MAX.	V_{IN}	TYP.	MAX.	TYP.
0.50	0.500	0.460	0.480	0.500	1.80	200	600	75.9
0.60	0.600	0.560	0.580	0.600	1.80	200	600	77.1
0.70	0.700	0.660	0.680	0.700	1.80	200	600	78.3
0.80	0.800	0.760	0.780	0.800	1.80	200	600	79.4
0.90	0.900	0.860	0.880	0.900	1.80	200	600	80.4
1.00	1.000	0.960	0.980	1.000	1.80	200	600	81.5
1.10	1.100	1.058	1.080	1.102	1.80	200	600	82.5
1.20	1.200	1.156	1.180	1.204	1.80	200	600	83.4
1.30	1.300	1.254	1.280	1.306	1.80	200	600	84.3
1.40	1.400	1.352	1.380	1.408	1.90	200	600	85.2
1.50	1.500	1.450	1.480	1.510	2.00	200	600	86.0
1.60	1.600	1.548	1.580	1.612	2.10	200	600	86.8
1.70	1.700	1.646	1.680	1.714	2.20	200	600	87.5
1.80	1.800	1.744	1.780	1.816	2.30	200	600	88.2
1.90	1.900	1.842	1.880	1.918	2.40	200	600	88.9
2.00	2.000	1.940	1.980	2.020	2.50	210	630	89.5
2.10	2.100	2.038	2.080	2.122	2.60	210	630	90.1
2.20	2.200	2.136	2.180	2.224	2.70	210	630	90.6
2.30	2.300	2.234	2.280	2.326	2.80	210	630	91.1
2.40	2.400	2.332	2.380	2.428	2.90	210	630	91.6
2.50	2.500	2.430	2.480	2.530	3.00	220	660	92.0
2.60	2.600	2.528	2.580	2.632	3.10	220	660	92.3
2.70	2.700	2.626	2.680	2.734	3.20	220	660	92.6
2.80	2.800	2.724	2.780	2.836	3.30	220	660	92.9
2.90	2.900	2.822	2.880	2.938	3.40	230	690	93.2
3.00	3.000	2.920	2.980	3.040	3.50	230	690	93.4
3.10	3.100	3.018	3.080	3.142	3.60	230	690	93.5
3.20	3.200	3.116	3.180	3.244	3.70	240	720	93.6
3.30	3.300	3.214	3.280	3.346	3.80	240	720	93.7
3.40	3.400	3.312	3.380	3.448	3.90	240	720	93.7
3.50	3.500	3.410	3.480	3.550	4.00	250	750	93.7
3.60	3.600	3.508	3.580	3.652	4.10	250	750	93.7

With regard to other voltage, please contact our sales representative.

TEST CIRCUITS

< Test Circuit No.① >

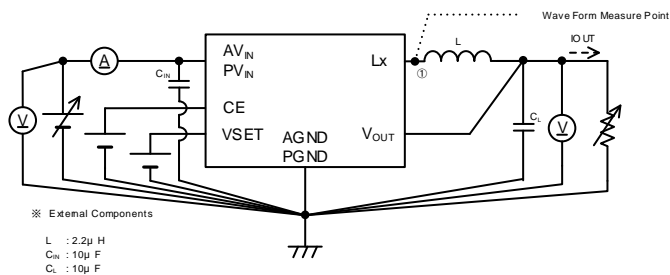

< Test Circuit No.② >

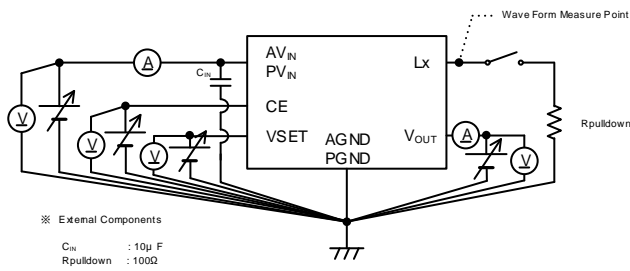

< Test Circuit No.③ >

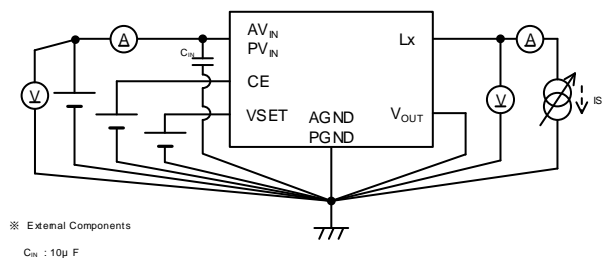

< Test Circuit No.④ >

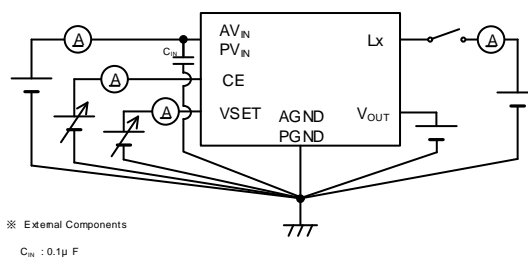

TYPICAL APPLICATION CIRCUIT

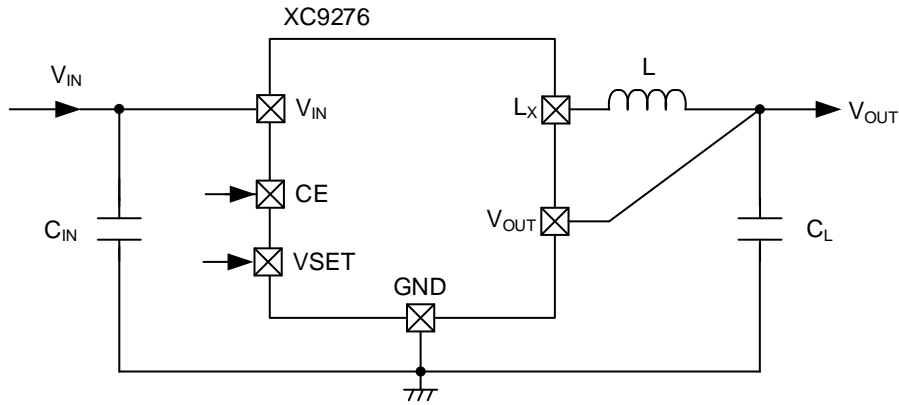

【Typical Examples】

	Manufacture	Product Number	Value	Size
L	Murata	DFE18SBN2R2MELL	2.2 μ H	1.6 x 0.8 x 0.8mm
		DFE252010F-2R2M		2.5 x 2.0 x 1.0mm
	TDK	MLP2520V2R2MT0S1		2.5 x 2.0 x 1.0mm
	Taiyo Yuden	MEKK2016H2R2M		2.0 x 1.6 x 0.8mm
	Sunlord	MWTC201608S2R2MT		2.0 x 1.6 x 0.8mm
	Alps Alpine	GLUHK2R201A		2.0 x 1.6 x 1.0mm
C_{IN}	Murata	GRM188R61A106ME69	10 μ F/10V	1.6 x 0.8 x 1.0mm
	Taiyo Yuden	LMK107BBJ106MALT		1.6 x 0.8 x 1.0mm
C_L	Murata	GRM188R61A106ME69	10 μ F/10V	1.6 x 0.8 x 1.0mm
		GRM188R60J226MEA0	22 μ F/6.3V	1.6 x 0.8 x 1.0mm
		GRM188R61A226ME15	22 μ F/10V	1.6 x 0.8 x 1.0mm
		GRM188R60J476ME15	47 μ F/6.3V	1.6 x 0.8 x 1.0mm
	Taiyo Yuden	LMK107BBJ106MALT	10 μ F/10V	1.6 x 0.8 x 1.0mm
		JMK107BBJ226MA	22 μ F/6.3V	1.6 x 0.8 x 1.0mm
	TDK	C1608X5R0J226M080AC	22 μ F/6.3V	1.6 x 0.8 x 1.0mm

* Please select the components taking into consideration the rated voltage, rated current, and ceramic capacitor DC bias characteristics, etc.

* An inductance value of 2.2 μ H \pm 20% or \pm 30% is recommended.

An inductor which is out of our recommendation value or has poor DC superimposition characteristics can attribute to a reduction of an output current performance and an efficiency performance.

* Please increase a capacitance value for C_L in order to reduce output ripple voltages.

C_L such as tantalum capacitors which have a larger ESR value can increase output ripple voltages.

OPERATIONAL EXPLANATION

The XC9276 series consists of a reference voltage supply, PFM comparator, Pch driver FET, Nch driver FET, current sensing circuit, PFM control circuit, CE control circuit, and others.

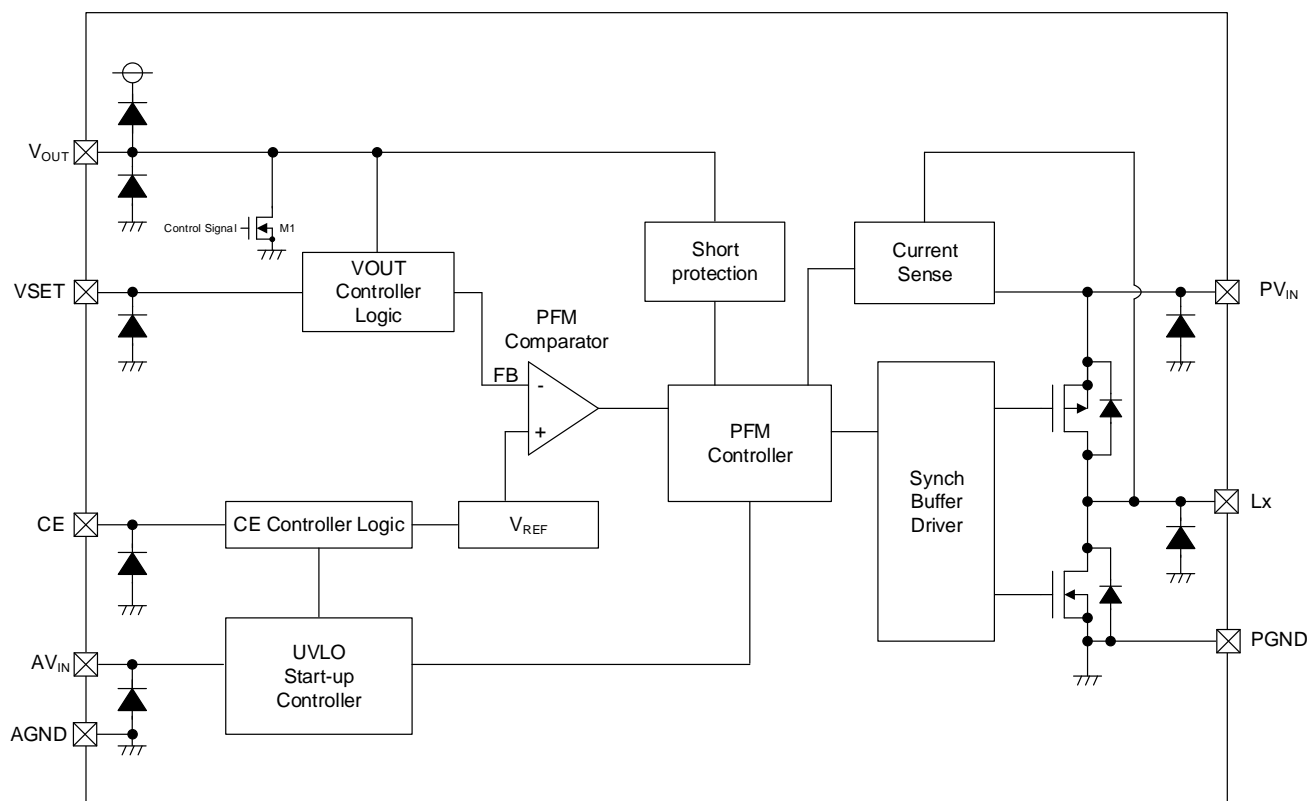

BLOCK DIAGRAM

The efficiency performance at a light load current is significantly improved compared to existing Torex products by implementing a current limit PFM as a control method and reducing a consumption current by IC itself.

OPERATIONAL EXPLANATION (Continued)

<Normal operation>

This IC controls the output voltage by adjusting the following ①~③ operation intervals in response to the output current.

The V_{OUT1} and V_{OUT2} output voltage average values during actual operation depend on V_{OUT1-2} , V_{OUT2-2} , and the ripple voltage during actual operation and are calculated as follows. For this reason, if the ripple voltage changes due to the influence of the input voltage, output voltage, or peripheral components, etc., the output voltage average value will change.

$$V_{OUT1} = V_{OUT1-2} + \text{Ripple Voltage} \times 1/2 \text{ (VSET= "L")}$$

$$V_{OUT2} = V_{OUT2-2} + \text{Ripple Voltage} \times 1/2 \text{ (VSET= "H")}$$

① The feedback voltage (FB voltage) is the voltage that results from dividing the output voltage with the VOUT Controller logic circuit. The PFM comparator compares this FB voltage to V_{REF} . When the FB voltage is lower than V_{REF} , the PFM comparator sends a signal to the PFM control circuit to turn on the Pch driver FET.

The On Time to Pch driver FET can be obtained by the following equation.

$$t_{ON} = L \times I_{PFM} / (V_{IN} - V_{OUT})$$

② When the Pch driver FET turns on, the coil current increases until the coil current reaches PFM Switching Current (I_{PFM}).

When the coil current reaches I_{PFM} , the Pch driver FET turns off and then the Nch driver FET turns on.

③ After the Nch driver FET turns on, the coil current will decrease and when the coil current goes down to approx. 0mA, the Nch driver FET will turn off.

The Pch driver FET and Nch driver FET remain off until the FB voltage becomes lower than the reference voltage V_{REF} .

The above ①~③ switching operations increase the FB voltage accompanying the output voltage increase, but if the PFM comparator determines the FB voltage is lower than the reference voltage V_{REF} before the coil current reaches 0mA, the Nch driver FET turns off and the status moves to ①.

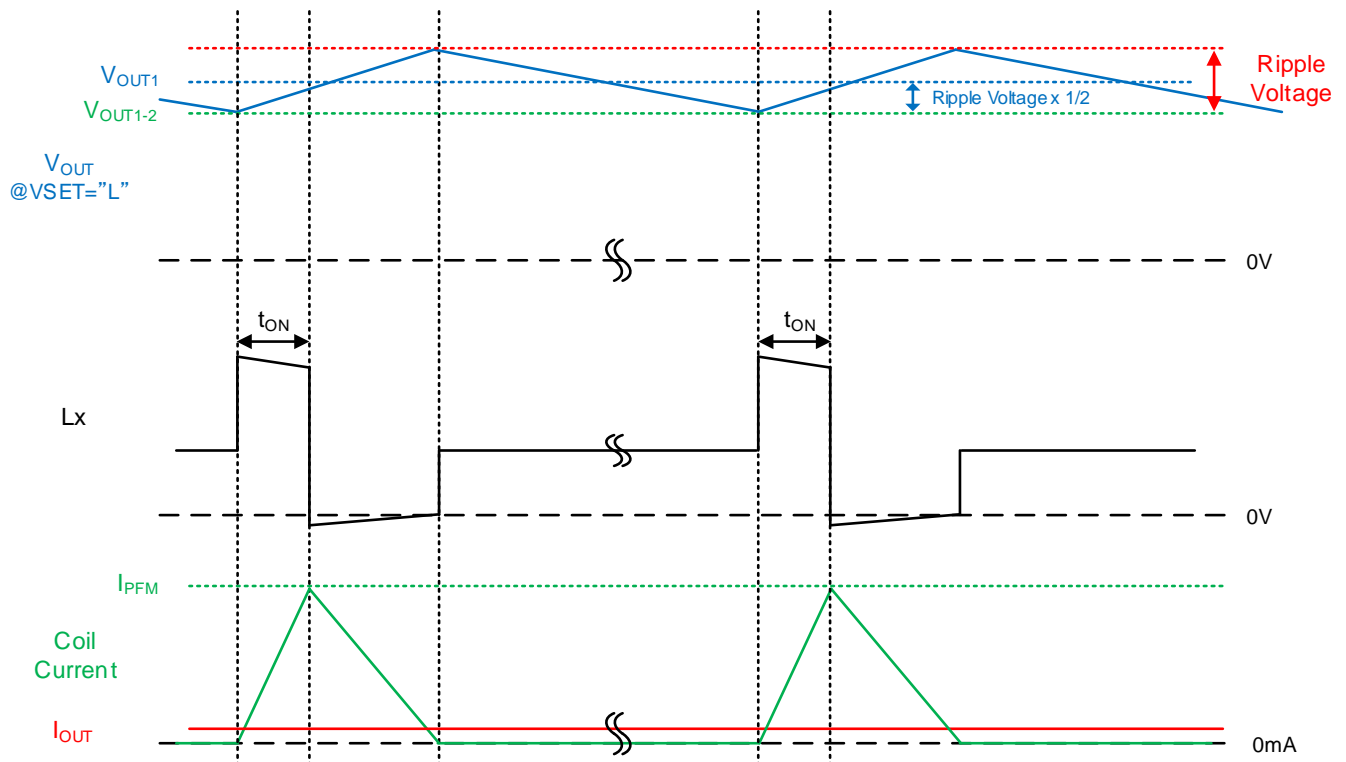

OPERATIONAL EXPLANATION (Continued)

< Maximum on-time function, 100% Duty operation >

When the input / output potential difference decreases, the on-time required for the coil current to reach I_{PFM} increases, and the output ripple voltage tends to increase. Therefore, under conditions where the input / output potential difference is small, excessive ripple voltage is suppressed by limiting the maximum on-time that the Pch driver FET can turn on after the FB voltage becomes higher than the reference voltage V_{REF} to $3.0\mu s$ (TYP.).

If the input / output potential difference is further reduced, the FB voltage is always lower than the reference voltage V_{REF} , so the 100% duty operation is performed and the Pch driver FET is always on.

At 100% duty, the current consumption of the IC increases compared to normal operation.

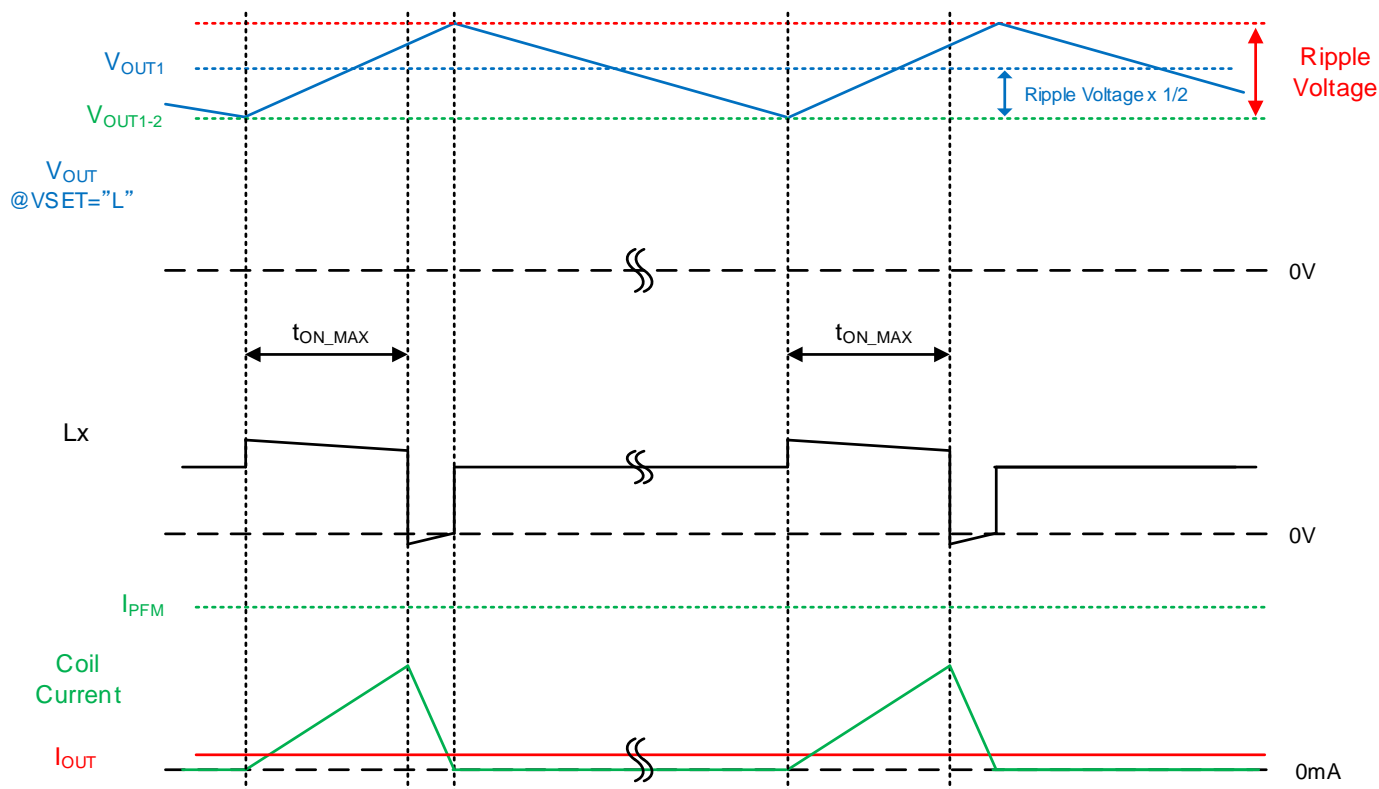

OPERATIONAL EXPLANATION (Continued)

<CE function>

When "H" voltage (V_{CEH}) is fed to the CE pin, normal operation starts after raising the output voltage with Start-up Mode.

When the "L" voltage (V_{CEL}) is fed to the CE pin, it enters the stand-by state and the current consumption is suppressed to $0.0\mu\text{A}$ (TYP.). Additionally, Pch MOS driver FET and Nch MOS driver FET are turned off.

<Start-up Mode>

After "H" voltage (V_{CEH}) is fed to CE pin and UVLO function is released, by the time when FB voltage goes up to $0.9 \times V_{REF}$, the startup mode operates.

Unlike the normal operation, the start-up mode stops the operation of the short-circuit protection function and prevents the IC from being inadvertently stopped.

In order to suppress the inrush current, the peak current of the coil is limited to $0.7 \times I_{PFM}$, and the Nch driver FET does not turn on and the coil current flows through the parasitic diode of the Nch driver FET.

The rise time of the output voltage depends on the output capacitance and output current.

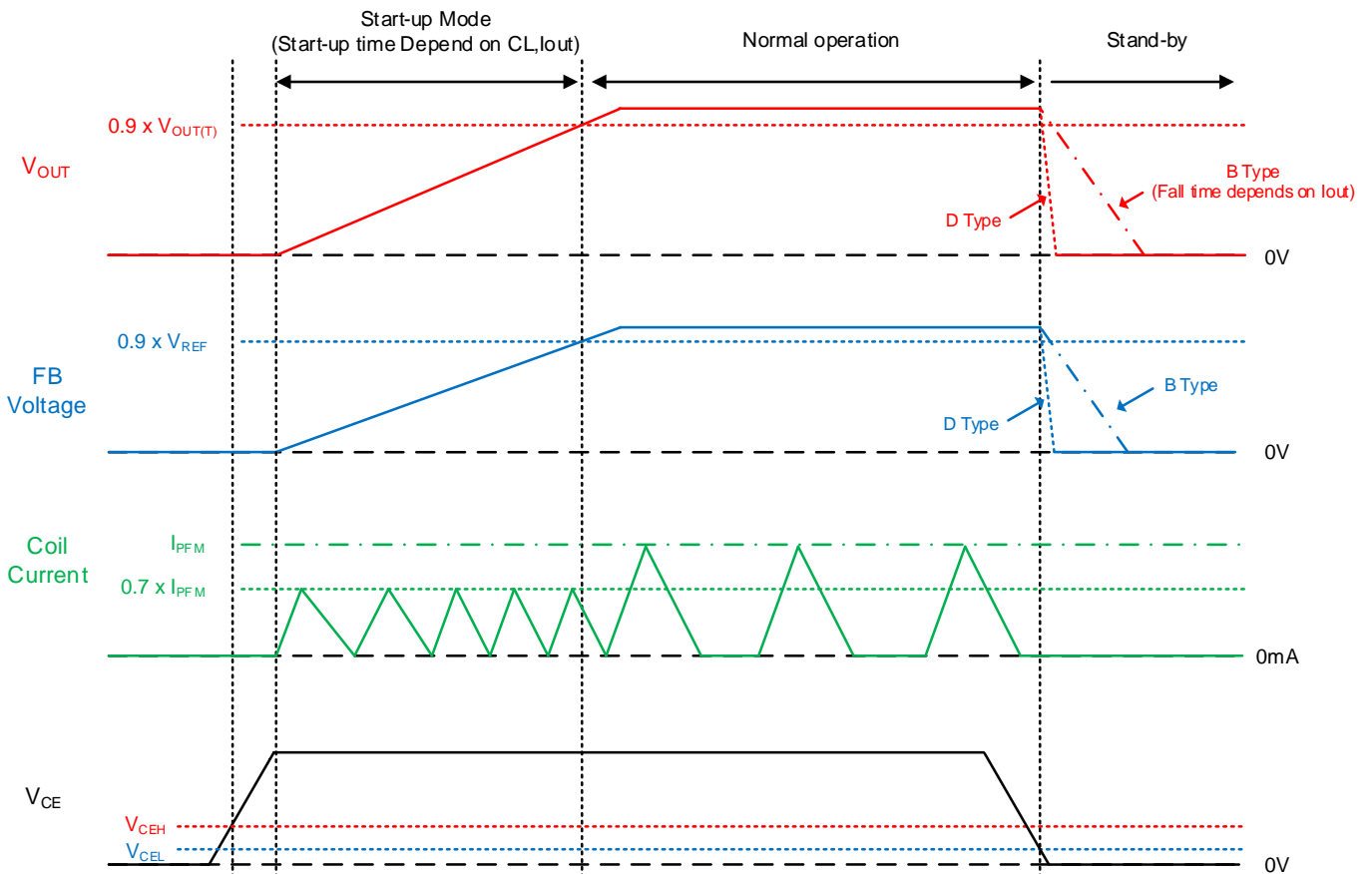

<UVLO function>

When the V_{IN} voltage becomes UVLO Detect Voltage (V_{UVLOD}) or less, the UVLO function operates to forcibly turn off the Pch MOS driver FET to prevent erroneous pulse output due to operation instability of the internal circuit.

During the UVLO function, the Pch driver FET and Nch driver FET turn off, and the Nch FET M1 between the V_{OUT} pin and GND pin turns on to discharge the output capacitance and make the output voltage be lower.

When the V_{IN} voltage becomes UVLO Release Voltage (V_{UVLOR}) or more, the UVLO function is canceled. After the UVLO function is canceled, the output voltage rises with the startup mode, and then the normal operation is performed.

Moreover, during the UVLO operation, the current consumption increases because the internal circuit is operating and the switching operation is stopped, not the stand-by state.

OPERATIONAL EXPLANATION (Continued)

<Short protection function>

•Case (a) : $V_{OUT1} \geq 1.2V$

The short-circuit protection function monitors the V_{OUT} pin voltage, and if the V_{OUT} pin voltage drops below the Short Protection Threshold Voltage (V_{SHORT}) due to a short circuit or overcurrent, the short circuit protection function operates.

When the short-circuit protection function is activated, the Pch driver FET and Nch driver FET are held off. If the V_{OUT} pin voltage exceeds the Short Protection Threshold Voltage (V_{SHORT}) after the short-circuit protection function is activated, normal operation resumes.

To cancel the short-circuit protection function, it is necessary to start the IC after putting the IC in the standby state with the CE function, or to raise the input voltage after setting the input voltage below the UVLO detection voltage (V_{UVLOD}).

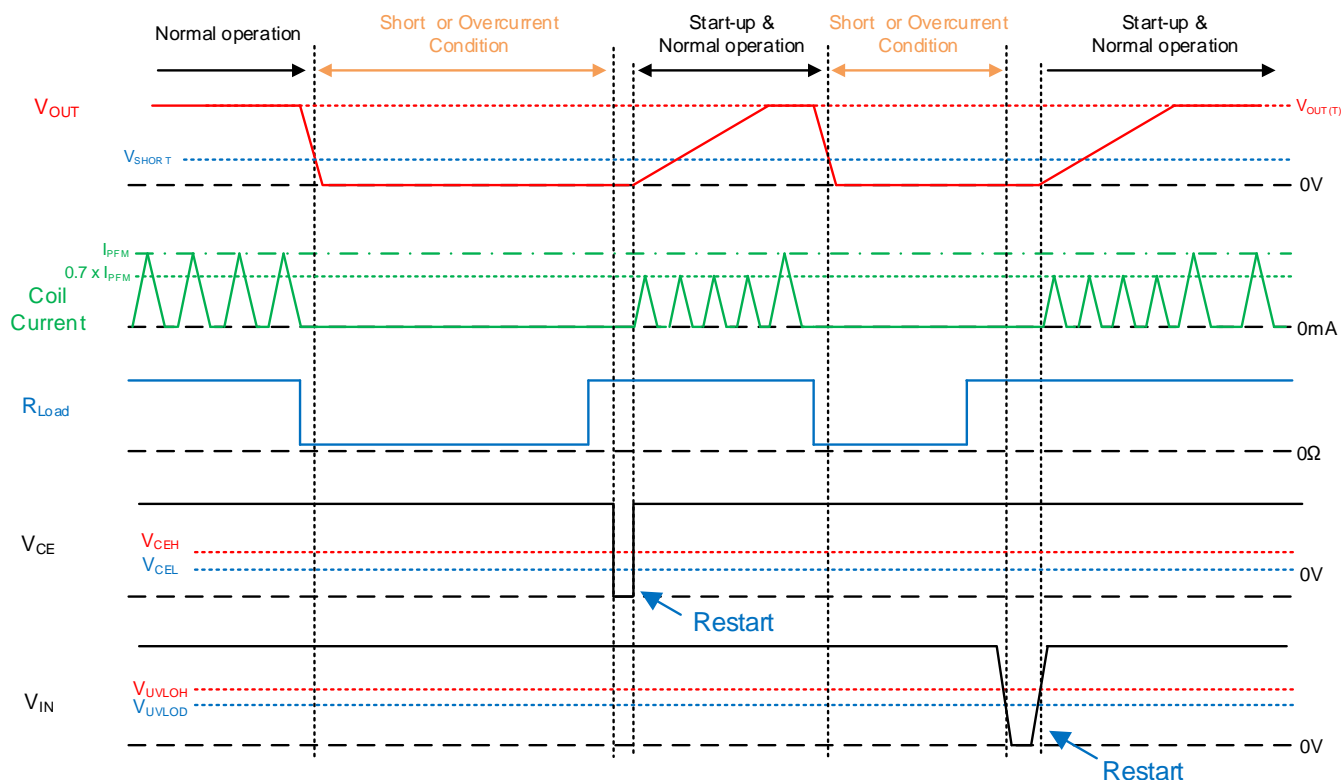

•Case (b) : $V_{OUT1} < 1.2V$

The short-circuit protection function is not implemented in the part numbers where V_{OUT1} is less than 1.2V. If a short circuit or overcurrent occurs, the output voltage will drop and switching operation will continue.

When the short-circuit state or excessive output current is released, the output voltage rises quickly to the set output voltage.

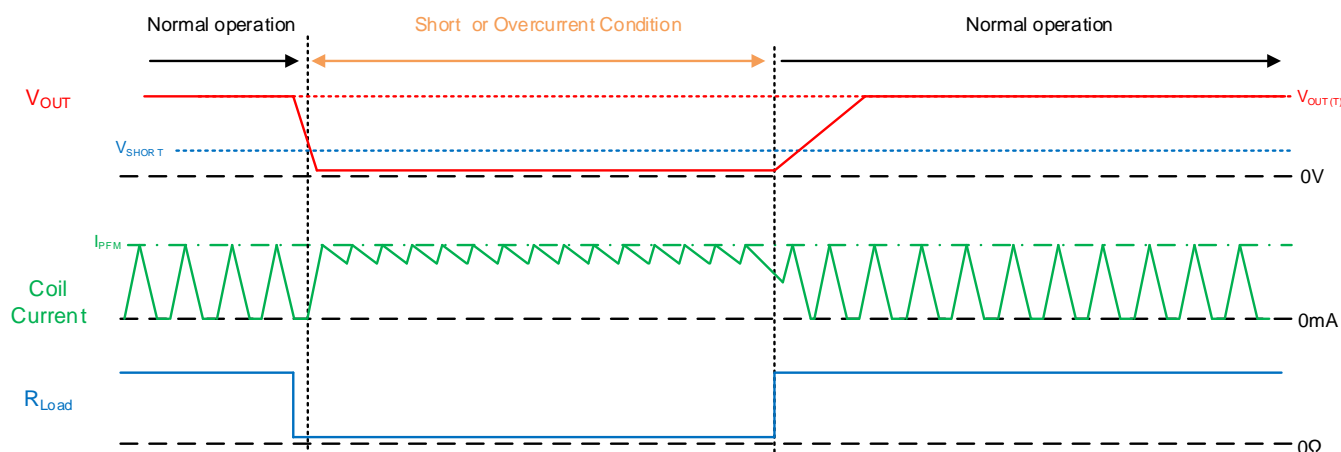

OPERATIONAL EXPLANATION (Continued)

< CL Discharge function (D type)>

On the XC9276 series, a CL discharge function is available as an option.

CL discharge function turns on the Nch FET M1 between the VOUT pin and GND pin when the stand-by condition in order to discharge the output capacitance quickly and make the output voltage be lower.

This prevents malfunctioning of the application in the event that a charge remains on CL when the IC is stand-by state.

The discharge time is determined by CL and the CL discharge resistance RDCHG, including the Nch FET M1. the discharge time of the output voltage is calculated by means of the equation below.

$$V = V_{OUT(T)} \times e^{-t/\tau}$$

$$t = \tau \ln(V_{OUT(T)} / V)$$

- V : Output voltage during discharge
- VOUT(T) : Output voltage
- t : Discharge time
- CL : Effective capacitance of Output capacitor
- RDCHG : CL auto-discharge resistance
- τ : $CL \times RDCHG$

Output Voltage Discharge characteristics

RDCHG = 45Ω (TYP) CL = 10μF
VIN = 5.0V

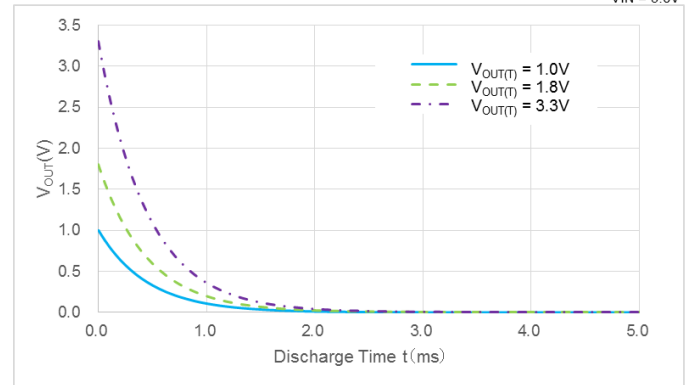

<Output Voltage selectable function>

When "H" voltage (VSETH) is fed to the VSET pin, the set output voltage operates as VOUT2, and when "L" voltage (VSETL) is fed, the set output voltage operates as VOUT1.

When the VSET pin voltage is switched during normal operation, the set output voltage is changed to the changed output voltage after a certain period.

VSET SIGNAL	Output Voltage	Comment
H	VOUT2	-
L	VOUT1	-
H → L	VOUT2 → VOUT1 (VOUT1 < VOUT2)	Output voltage starts to drop to VOUT1 30μs after "L" input. Falling speed depends on output current.
	VOUT2 → VOUT1 (VOUT1 > VOUT2)	Output voltage starts to rise to VOUT1 30μs after "L" input. Rise speed depends on IPFM.
L → H	VOUT1 → VOUT2 (VOUT1 < VOUT2)	Output voltage starts to rise to VOUT2 30μs after "H" input. Rise speed depends on IPFM.
	VOUT1 → VOUT2 (VOUT1 > VOUT2)	Output voltage starts to drop to VOUT2 30μs after "H" input. Falling speed depends on output current.

■ NOTE ON USE

1. Be careful not to exceed the absolute maximum ratings for externally connected components and this IC.
2. The DC/DC converter characteristics greatly depend not only on the characteristics of this IC but also on those of externally connected components, so refer to EXTERNAL COMPONENTS SELECTION and the specifications of each component and be careful when selecting the components. Be especially careful of the characteristics of the capacitor used for the load capacity C_L and use a capacitor with B characteristics (JIS Standard) or an X7R/X5R (EIA Standard) ceramic capacitor.
3. The CE pin and VSET pin does not have an internal pull-up or pull-down, etc. Apply the prescribed voltage to the CE pin and VSET pin.
If an intermediate voltage is fed to the CE and VSET pins, a through current will flow through the input stage of the CE and VSET pins, increasing current consumption.
4. At light loads or when IC operation is stopped, leakage current from the Pch driver FET may cause the output voltage to rise.
5. Switching operation may be performed continuously due to internal delay or input offset of the PFM comparator circuit.
If the switching operation continues, the output ripple voltage increases and the output voltage rises as the ripple voltage increases.
6. When the input / output potential difference is small, the ripple voltage increases and the output voltage may increase.
7. Since the short-circuit protection function is not implemented in the part number where both of or either V_{OUT1} or V_{OUT2} is less than 1.2V, the coil current may be superposed under the condition of high input voltage and excessive output current.
8. During start-up mode, the peak current of the coil is set lower than in normal operation, so the output voltage may not rise under conditions where the output current is large during start-up.
9. To suppress current consumption, UVLO detection is performed only for a certain period after the Pch driver FET is turned on.
For this reason, the UVLO function may not operate if the VIN pin voltage instantaneously drops below the UVLO detection voltage (V_{UVLOD}).
10. Under the conditions of $V_{in} \leq 2.7V$, set output voltage $\leq 1.0V$ and $T_a \geq 65^\circ C$, the efficiency can drastically drop.
Normally after the Nch driver FET turns on, the coil current falls to 0mA, and then Nch driver FET turns off.
Under the above conditions, however, before the coil current falls to 0mA, Nch driver FET turns off and its loss increases, which leads to the drop of efficiency.
11. For temporary, transitional voltage drop or voltage rising phenomenon, the IC is liable to malfunction should the ratings be exceeded.
12. Torex places an importance on improving our products and their reliability. We request that users incorporate fail-safe designs and post-aging protection treatment when using Torex products in their systems.

NOTE ON USE (Continued)

13. Instructions of pattern layouts

- (1) In order to stabilize V_{IN} voltage level, we recommend that a by-pass capacitor (C_{IN}) be connected as close as possible to the V_{IN} & GND pins.
- (2) Please mount each external component as close to the IC as possible.
- (3) Wire external components as close to the IC as possible and use thick, short connecting traces to reduce the circuit impedance.
- (4) Make sure that the PCB GND traces are as thick as possible, as variations in ground potential caused by high ground currents at the time of switching may result in instability of the IC.
- (5) This series' internal driver FET bring on heat because of the output current and ON resistance of Pch driver FET.

<Reference pattern layout >

WLP-6-03

Layer 1

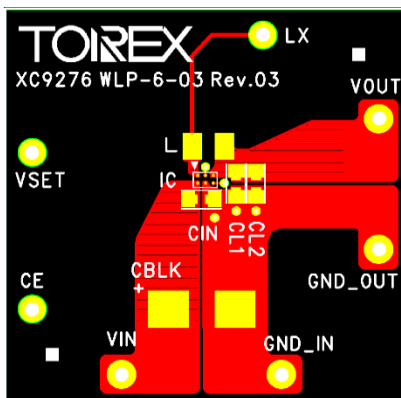

Layer 2

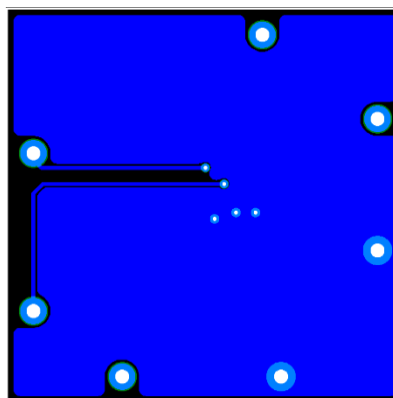

SOT-26W

Layer 1

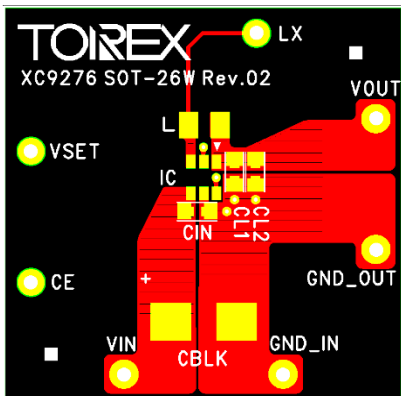

Layer 2

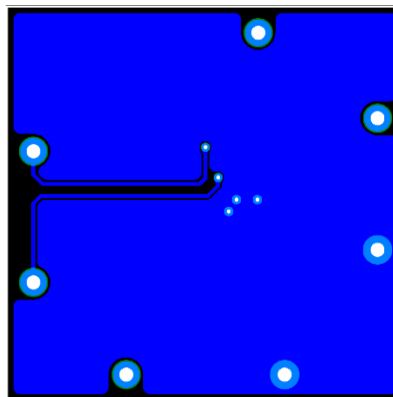

USP-8B06

Layer 1

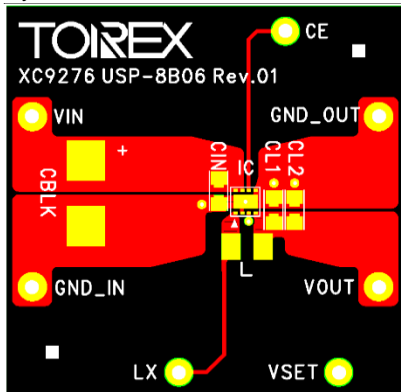

Layer 2

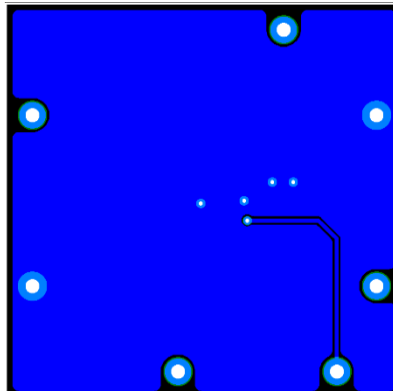

■ NOTE ON USE (Continued)

14. Note on mounting (WLP)

- (1) Mount pad design should be optimized for user's conditions.
- (2) Sn-AG-Cu is used for the package terminals. If eutectic solder is used, mounting reliability is decreased. Please do not use eutectic solder paste.
- (3). When underfill agent is used to increase interfacial bonding strength, please take enough evaluation for selection. Some underfill materials and applied conditions may decrease bonding reliability.
- (4) The IC has exposed surface of silicon material in the top marking face and sides so that it is weak against mechanical damages. Please take care of handling to avoid cracks and breaks.
- (5) The IC has exposed surface of silicon material in the top marking face and sides. Please use the IC with keeping the circuit open (avoiding short-circuit from the out).
- (6) Semi-transparent resin is coated on the circuit face of the package. Please be noted that the usage under strong lights may affects device performance.

TYPICAL PERFORMANCE CHARACTERISTICS

(1) Efficiency vs. Output Current

XC9276($V_{OUT}=1.8V$)

$L = \text{GLUHK2R201A}(2.2\mu\text{H})$
 $C_{IN} = \text{GRM188R61A106ME69}(10\mu\text{F}/10V)$
 $C_L = \text{GRM188R61A106ME69}(10\mu\text{F}/10V)$

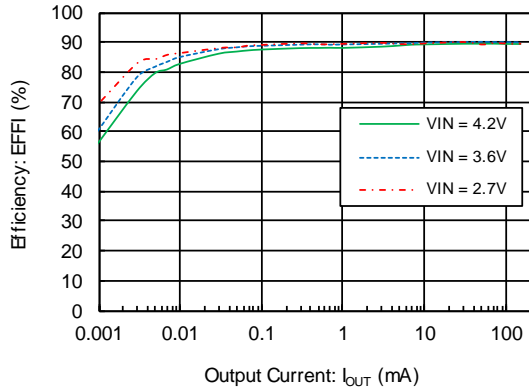

XC9276($V_{OUT}=3.0V$)

$L = \text{GLUHK2R201A}(2.2\mu\text{H})$
 $C_{IN} = \text{GRM188R61A106ME69}(10\mu\text{F}/10V)$
 $C_L = \text{GRM188R61A106ME69}(10\mu\text{F}/10V)$

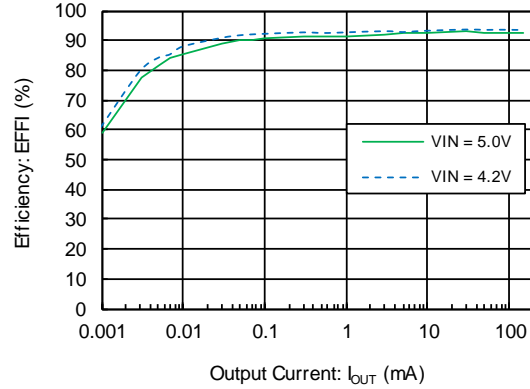

XC9276($V_{OUT}=1.8V$)

$V_{IN} = 3.6V$
 $L = \text{GLUHK2R201A}(2.2\mu\text{H})$
 $C_{IN} = \text{GRM188R61A106ME69}(10\mu\text{F}/10V)$
 $C_L = \text{GRM188R61A106ME69}(10\mu\text{F}/10V)$

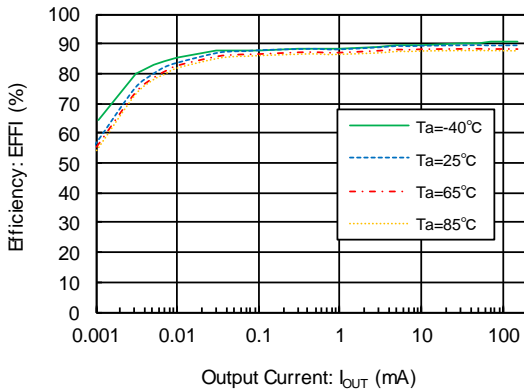

XC9276($V_{OUT}=3.0V$)

$V_{IN} = 3.6V$
 $L = \text{GLUHK2R201A}(2.2\mu\text{H})$
 $C_{IN} = \text{GRM188R61A106ME69}(10\mu\text{F}/10V)$
 $C_L = \text{GRM188R61A106ME69}(10\mu\text{F}/10V)$

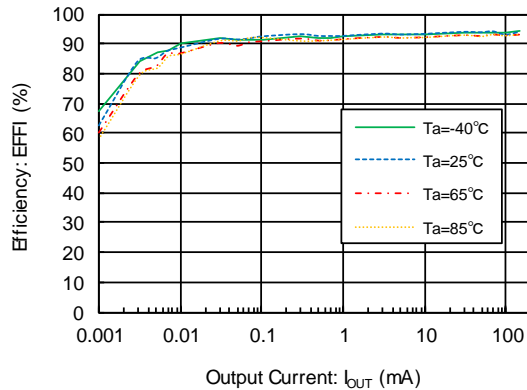

XC9276($V_{OUT}=1.8V$)

$V_{IN} = 5.0V$
 $L = \text{GLUHK2R201A}(2.2\mu\text{H})$
 $C_{IN} = \text{GRM188R61A106ME69}(10\mu\text{F}/10V)$
 $C_L = \text{GRM188R61A106ME69}(10\mu\text{F}/10V)$

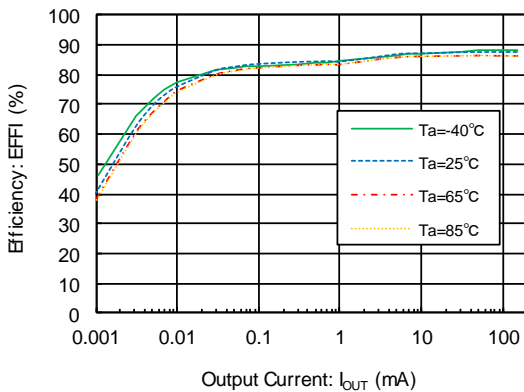

XC9276($V_{OUT}=3.0V$)

$V_{IN} = 5.0V$
 $L = \text{GLUHK2R201A}(2.2\mu\text{H})$
 $C_{IN} = \text{GRM188R61A106ME69}(10\mu\text{F}/10V)$
 $C_L = \text{GRM188R61A106ME69}(10\mu\text{F}/10V)$

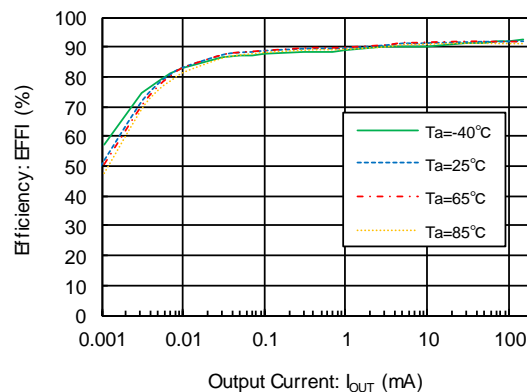

TYPICAL PERFORMANCE CHARACTERISTICS (Continued)

XC9276($V_{OUT}=0.5V$)

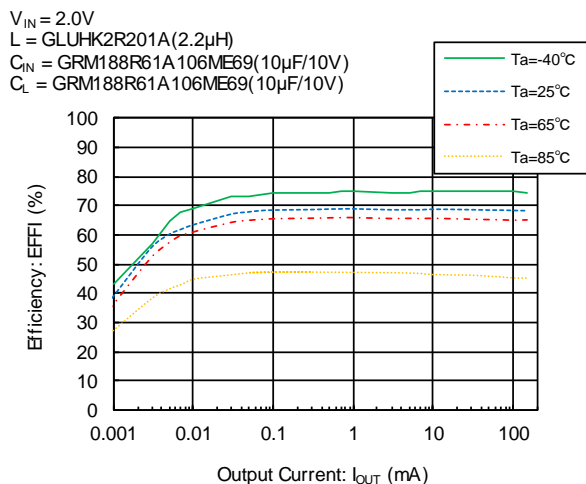

XC9276($V_{OUT}=0.5V$)

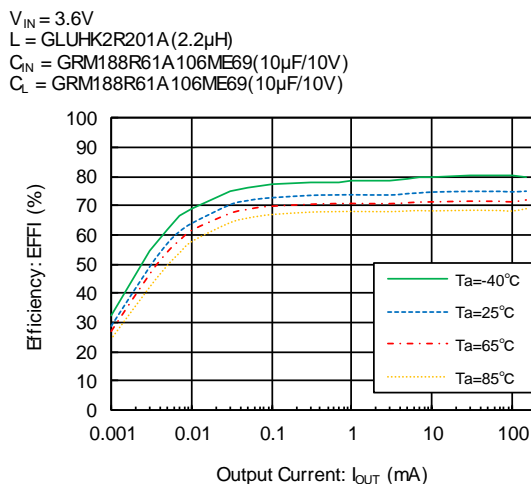

XC9276($V_{OUT}=0.5V$)

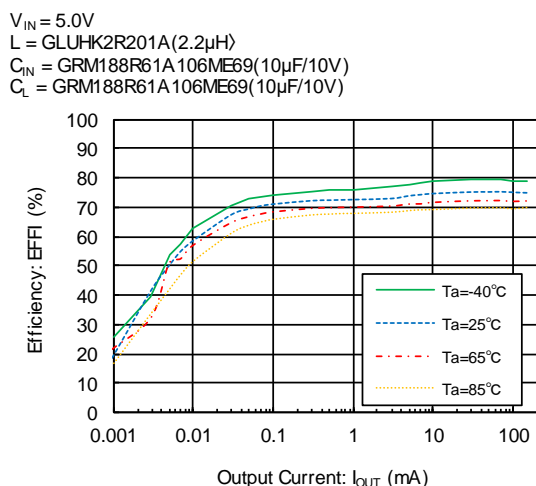

XC9276($V_{OUT}=1.8V$)

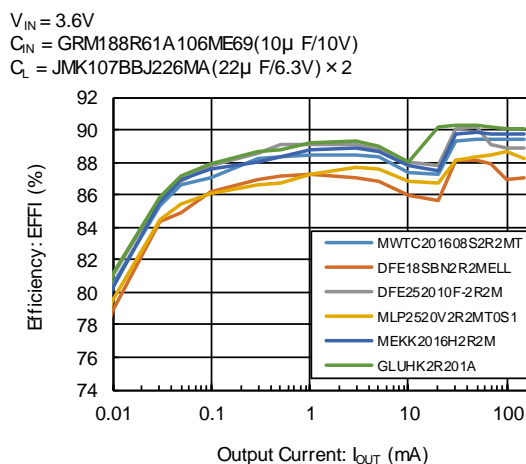

(2) Output Voltage vs. Output Current

XC9276($V_{OUT}=1.8V$)

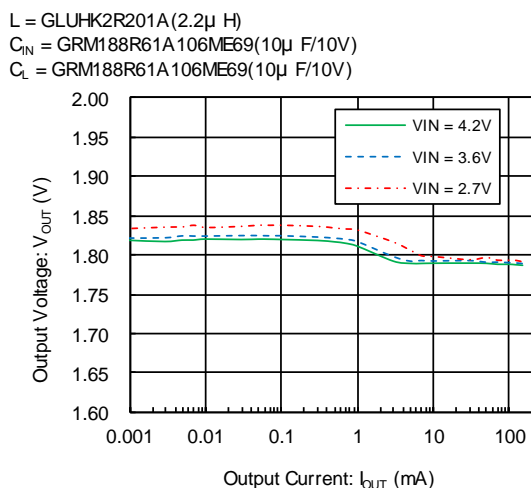

XC9276($V_{OUT}=3.0V$)

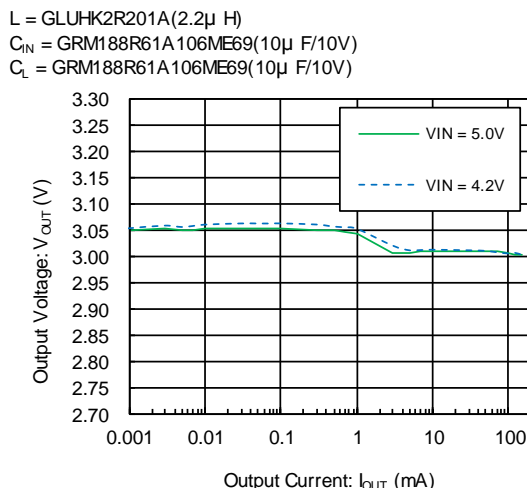

TYPICAL PERFORMANCE CHARACTERISTICS (Continued)

(3) Ripple Voltage vs. Output Current

XC9276($V_{OUT}=1.8V$)

L = GLUHK2R201A(2.2 μ H)
 C_{IN} = GRM188R61A106ME69(10 μ F/10V)
 C_L = GRM188R61A106ME69(10 μ F/10V)

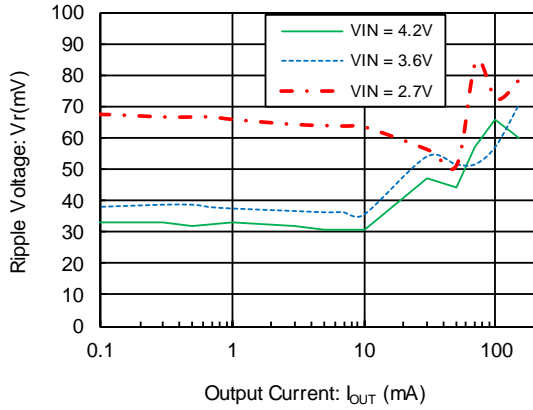

XC9276($V_{OUT}=3.0V$)

L = GLUHK2R201A(2.2 μ H)
 C_{IN} = GRM188R61A106ME69(10 μ F/10V)
 C_L = GRM188R61A106ME69(10 μ F/10V)

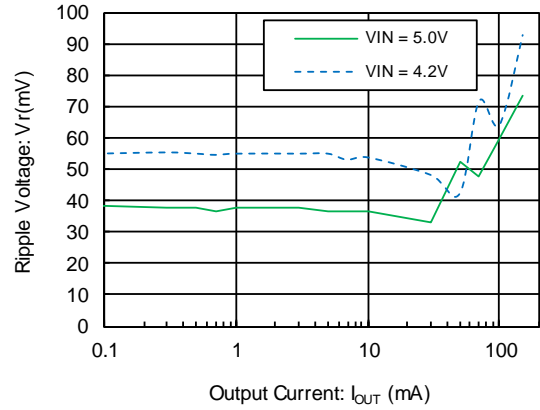

XC9276($V_{OUT}=1.8V$)

L = GLUHK2R201A(2.2 μ H)
 C_{IN} = GRM188R61A106ME69(10 μ F/10V)
 C_L = JMK107BBJ226MA(22 μ F/6.3V)

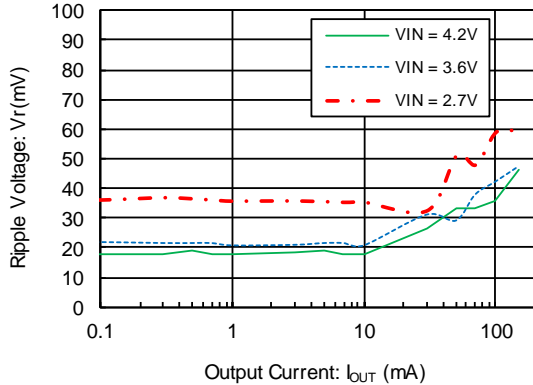

XC9276($V_{OUT}=3.0V$)

L = GLUHK2R201A(2.2 μ H)
 C_{IN} = GRM188R61A106ME69(10 μ F/10V)
 C_L = JMK107BBJ226MA(22 μ F/6.3V)

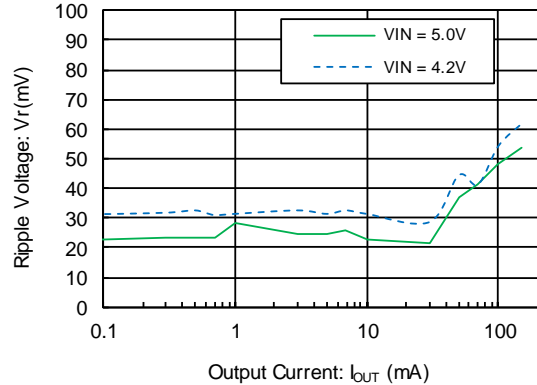

XC9276($V_{OUT}=1.8V$)

L = GLUHK2R201A(2.2 μ H)
 C_{IN} = GRM188R61A106ME69(10 μ F/10V)
 C_L = JMK107BBJ226MA(22 μ F/6.3V) $\times 2$

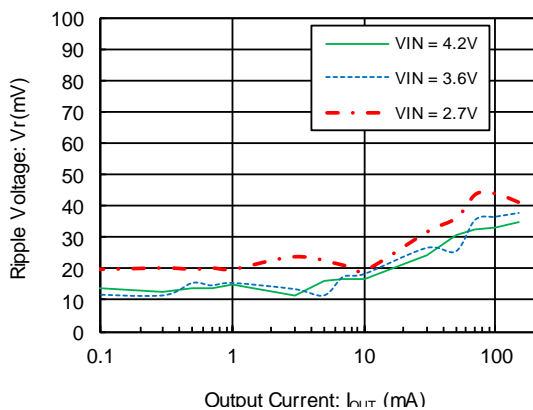

XC9276($V_{OUT}=3.0V$)

L = GLUHK2R201A(2.2 μ H)
 C_{IN} = GRM188R61A106ME69(10 μ F/10V)
 C_L = JMK107BBJ226MA(22 μ F/6.3V) $\times 2$

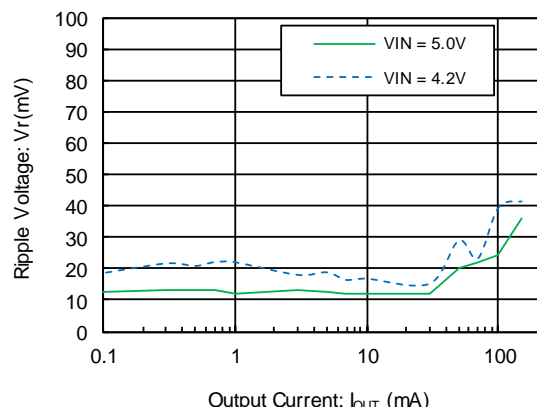

■ TYPICAL PERFORMANCE CHARACTERISTICS (Continued)

(4) Output Voltage vs. Ambient Temperature

XC9276($V_{OUT1}=1.8V$)

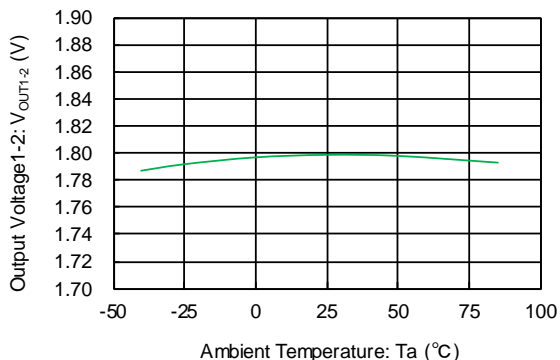

(5) UVLO Voltage vs. Ambient Temperature

XC9276

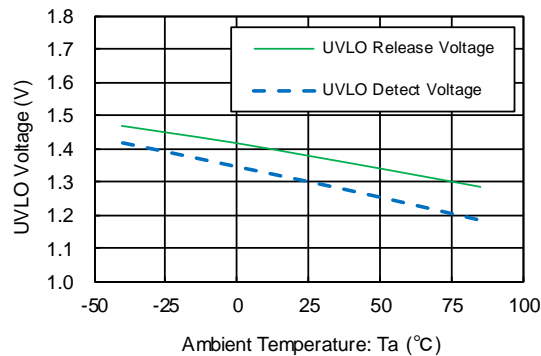

(6) Quiescent Current vs. Ambient Temperature

XC9276($V_{OUT}=0.6V$)

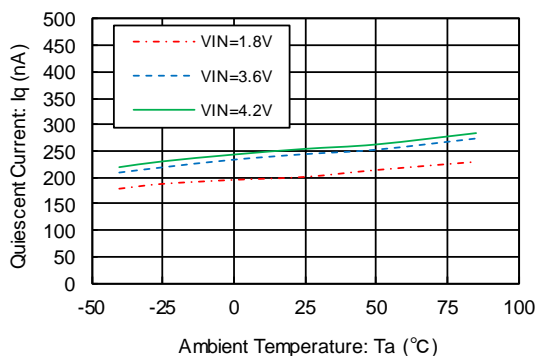

(7) Stand-by Current vs. Ambient Temperature

XC9276

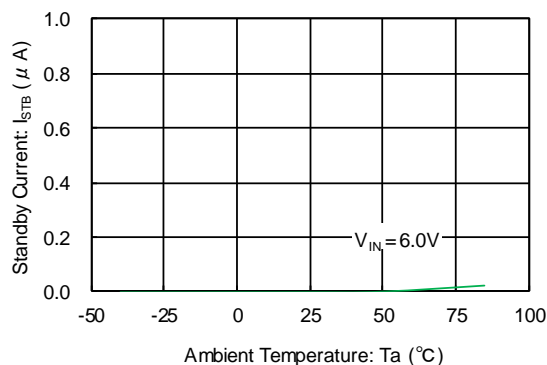

(8) PFM Switching Current vs. Ambient Temperature

XC9276($V_{OUT}=0.6V$)

$L = \text{GLUHK2R201A}(2.2\mu\text{H})$,
 $C_{IN} = \text{GRM188R61A106ME69}(10\mu\text{F}/10V)$
 $C_L = \text{GRM188R61A106ME69}(10\mu\text{F}/10V)$

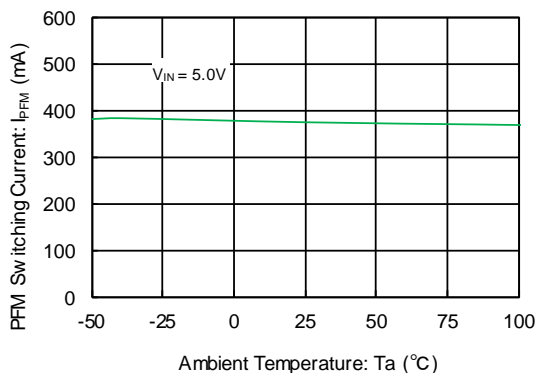

(9) Lx SW "H" ON Resistance vs. Ambient Temperature

XC9276

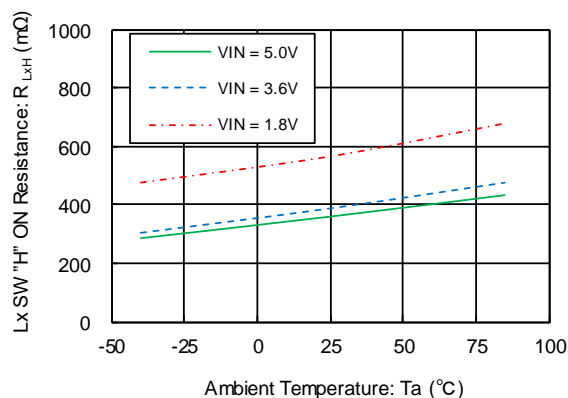

TYPICAL PERFORMANCE CHARACTERISTICS (Continued)

(10) Lx SW "L" ON Resistance vs. Ambient Temperature

XC9276

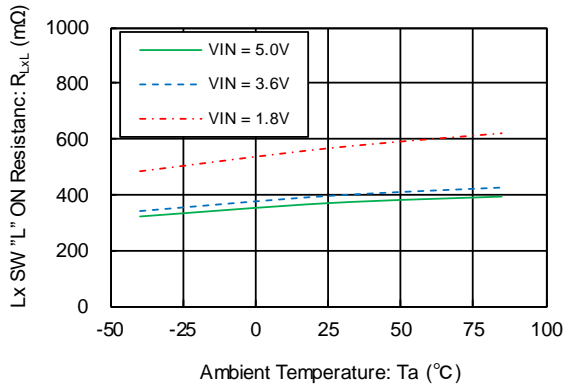

(11) Lx SW "H" Leakage Current vs. Ambient Temperature

XC9276

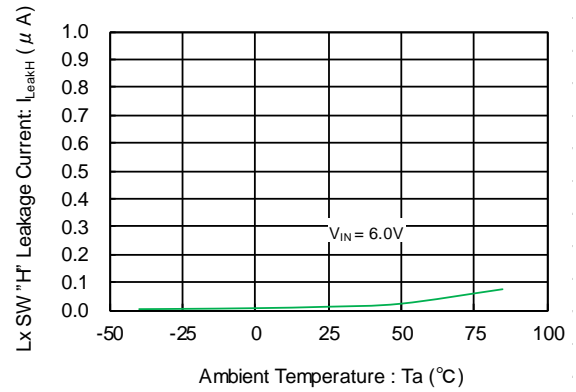

(12) Lx SW "L" Leakage Current vs. Ambient Temperature

XC9276

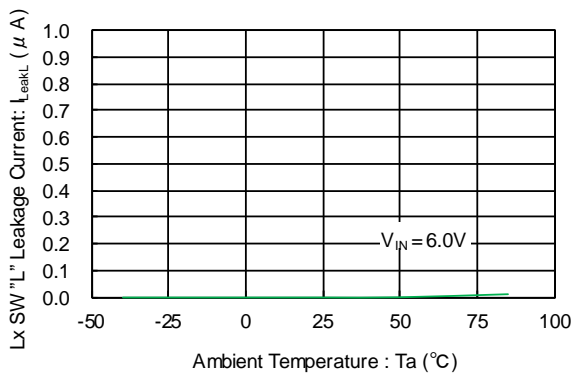

(13) CE "H" Voltage vs. Ambient Temperature

XC9276

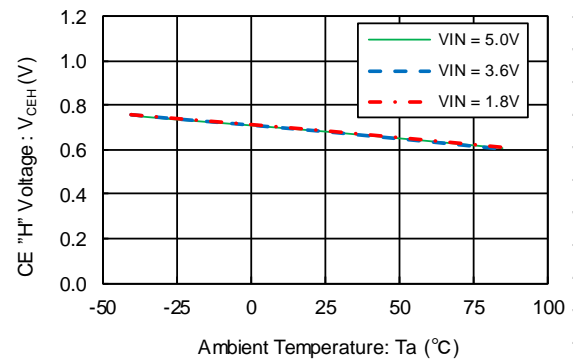

(14) CE "L" Voltage vs. Ambient Temperature

XC9276

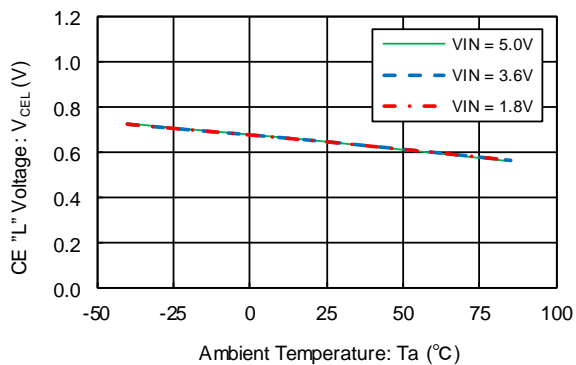

(15) VSET "H" Voltage vs. Ambient Temperature

XC9276

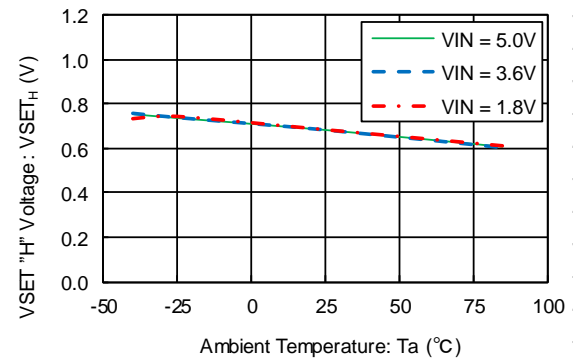

TYPICAL PERFORMANCE CHARACTERISTICS (Continued)

(16) VSET "L" Voltage vs. Ambient Temperature

XC9276

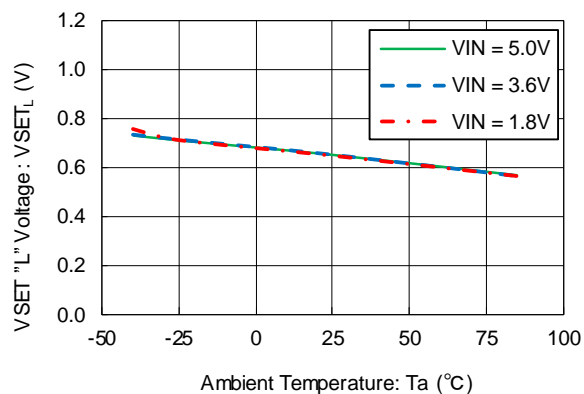

(17) Short Protection Threshold vs. Ambient Temperature

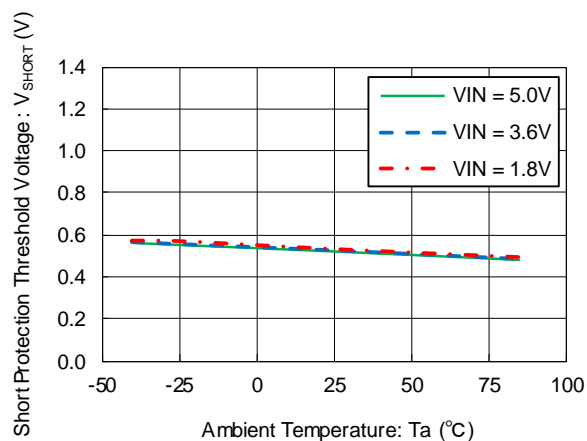

(18) C_L Discharge Resistance vs. Ambient Temperature

XC9276

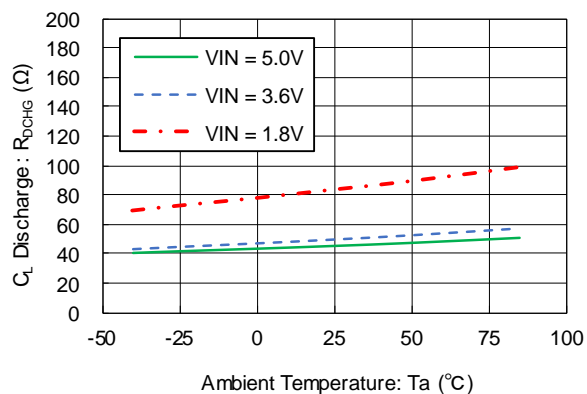

TYPICAL PERFORMANCE CHARACTERISTICS (Continued)

(19) Load Transient Responses

XC9276DB90

$V_{IN} = 3.6V, V_{OUT} = 1.8V, V_{SET} = 0.0V, I_{OUT} = 10\mu A \Rightarrow 50mA$
 $tr = 5\mu s$
 $L = GLUHK2R201A(2.2\mu H)$
 $C_{IN} = GRM188R61A106ME69(10\mu F/10V)$
 $C_L = JMK107BBJ226MA(22\mu F/6.3V) \times 2$

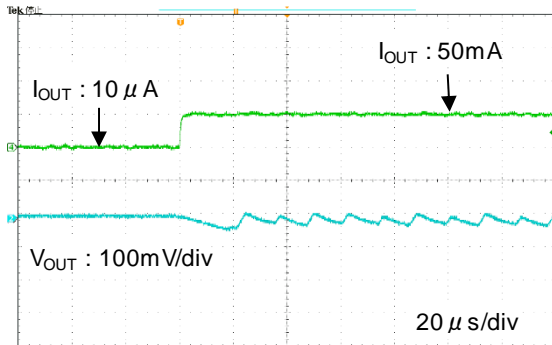

XC9276DB90

$V_{IN} = 3.6V, V_{OUT} = 1.8V, V_{SET} = 0V, I_{OUT} = 50mA \Rightarrow 10\mu A$
 $tf = 5\mu s$
 $L = GLUHK2R201A(2.2\mu H)$
 $C_{IN} = GRM188R61A106ME69(10\mu F/10V)$
 $C_L = JMK107BBJ226MA(22\mu F/6.3V) \times 2$

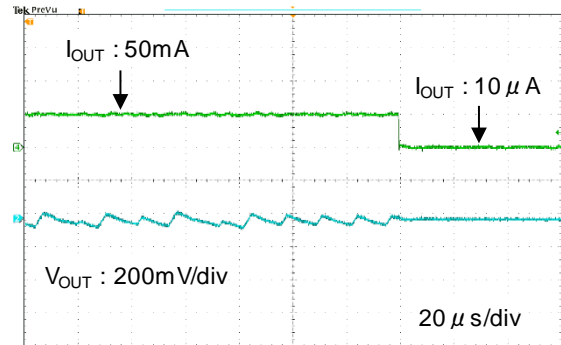

XC9276DB90

$V_{IN} = 3.6V, V_{OUT} = 3.0V, V_{SET} = 3.6V, I_{OUT} = 10\mu A \Rightarrow 50mA$
 $tr = 5\mu s$
 $L = GLUHK2R201A(2.2\mu H)$
 $C_{IN} = GRM188R61A106ME69(10\mu F/10V)$
 $C_L = JMK107BBJ226MA(22\mu F/6.3V) \times 2$

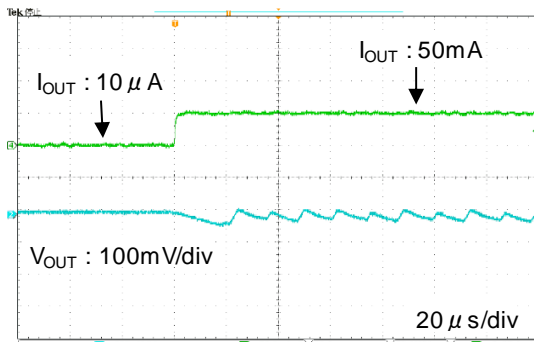

XC9276DB90

$V_{IN} = 3.6V, V_{OUT} = 3.0V, V_{SET} = 3.6V, I_{OUT} = 50mA \Rightarrow 10\mu A$
 $tf = 5\mu s$
 $L = GLUHK2R201A(2.2\mu H)$
 $C_{IN} = GRM188R61A106ME69(10\mu F/10V)$
 $C_L = JMK107BBJ226MA(22\mu F/6.3V) \times 2$

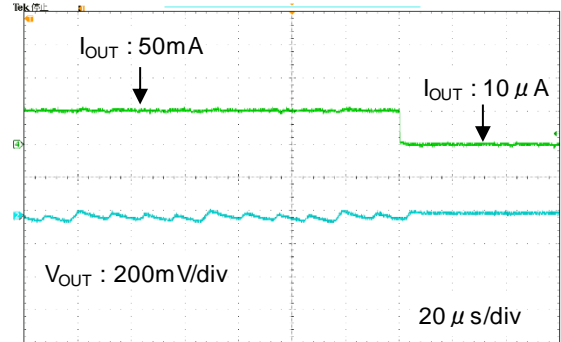

■ TYPICAL PERFORMANCE CHARACTERISTICS (Continued)

(20) Output voltage selectable function

XC9276DB90

$V_{IN} = 3.6V$, $V_{OUT(T)} = 1.8V \Rightarrow 3.0V$, $I_{OUT} = 10 \mu A$
 $V_{SET} = 0.0V \Rightarrow 3.6V$, $t_r = 5 \mu s$
 $L = \text{GLUHK2R201A}(2.2 \mu H)$
 $C_{IN} = \text{GRM188R61A106ME69}(10 \mu F/10V)$
 $C_L = \text{JMK107BBJ226MA}(22 \mu F/6.3V) \times 2$

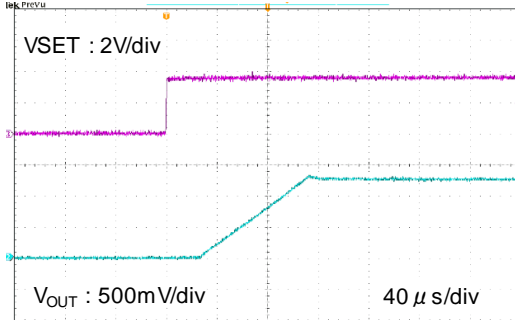

XC9276DB90

$V_{IN} = 3.6V$, $V_{OUT(T)} = 3.0V \Rightarrow 1.8V$, $I_{OUT} = 10 \mu A$
 $V_{SET} = 3.6V \Rightarrow 0.0V$, $t_f = 5 \mu s$
 $L = \text{GLUHK2R201A}(2.2 \mu H)$
 $C_{IN} = \text{GRM188R61A106ME69}(10 \mu F/10V)$
 $C_L = \text{JMK107BBJ226MA}(22 \mu F/6.3V) \times 2$

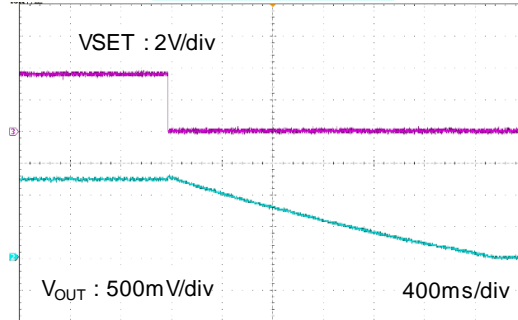

XC9276DB90

$V_{IN} = 3.6V$, $V_{OUT(T)} = 1.8V \Rightarrow 3.0V$, $I_{OUT} = 50mA$
 $V_{SET} = 0.0V \Rightarrow 3.6V$, $t_r = 5 \mu s$
 $L = \text{GLUHK2R201A}(2.2 \mu H)$
 $C_{IN} = \text{GRM188R61A106ME69}(10 \mu F/10V)$
 $C_L = \text{JMK107BBJ226MA}(22 \mu F/6.3V) \times 2$

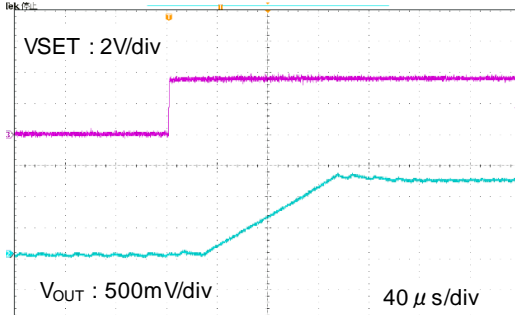

XC9276DB90

$V_{IN} = 3.6V$, $V_{OUT(T)} = 3.0V \Rightarrow 1.8V$, $I_{OUT} = 50mA$
 $V_{SET} = 3.6V \Rightarrow 0.0V$, $t_f = 5 \mu s$
 $L = \text{GLUHK2R201A}(2.2 \mu H)$
 $C_{IN} = \text{GRM188R61A106ME69}(10 \mu F/10V)$
 $C_L = \text{JMK107BBJ226MA}(22 \mu F/6.3V) \times 2$

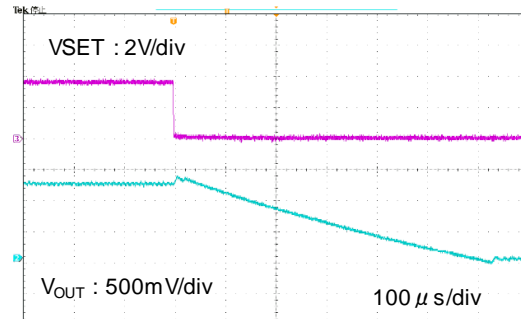

(21) Startup Mode

XC9276DB90

$V_{IN} = 3.6V$, $V_{OUT} = 1.8V$, $V_{CE} = 0.0V \Rightarrow 3.6V$, $I_{OUT} = 50mA$
 $t_r = 5 \mu s$
 $L = \text{GLUHK2R201A}(2.2 \mu H)$,
 $C_{IN} = \text{GRM188R61A106ME69}(10 \mu F/10V)$
 $C_L = \text{JMK107BBJ226MA}(22 \mu F/6.3V) \times 2$

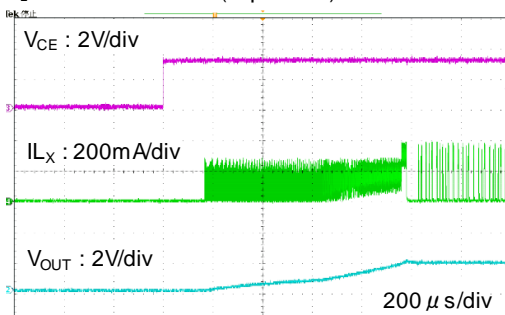

XC9276DB90

$V_{IN} = 3.6V$, $V_{OUT} = 3.0V$, $V_{CE} = 0.0V \Rightarrow 3.6V$, $I_{OUT} = 50mA$
 $t_r = 5 \mu s$
 $L = \text{GLUHK2R201A}(2.2 \mu H)$,
 $C_{IN} = \text{GRM188R61A106ME69}(10 \mu F/10V)$
 $C_L = \text{JMK107BBJ226MA}(22 \mu F/6.3V) \times 2$

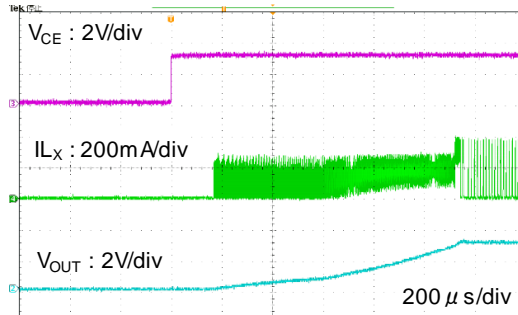

■ PACKAGING INFORMATION

For the latest package information go to, www.torexsemi.com/technical-support/packages

PACKAGE	OUTLINE / LAND PATTERN	THERMAL CHARACTERISTICS
WLP-6-03	WLP-6-03 PKG	WLP-6-03 Power Dissipation
SOT-26W	SOT-26W PKG	SOT-26W Power Dissipation
USP-8B06	USP-8B06 PKG	USP-8B06 Power Dissipation

MARKING RULE

SOT-26W

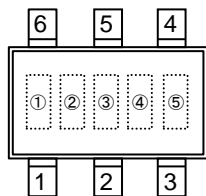

WLP-6-03

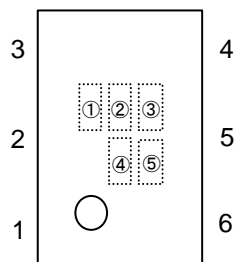

USP-8B06

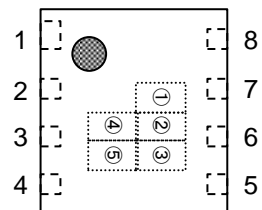

① represents product series

MARK	PRODUCT SERIES
A	XC9276*****R-G

②,③ represents internal sequential number

01~09, 10~99, A0~A9, B0~B9...Z0~Z9, AA~AZ, BA~BZ...ZA~ZZ repeated.

(G, I, J, O, Q, W excluded)

④,⑤ represents production lot number

01~09, 0A~0Z, 11...9Z, A1~A9, AA...Z9, ZA~ZZ in order.

(G, I, J, O, Q, W excluded)

* No character inversion used.

1. The product and product specifications contained herein are subject to change without notice to improve performance characteristics. Consult us, or our representatives before use, to confirm that the information in this datasheet is up to date.
2. The information in this datasheet is intended to illustrate the operation and characteristics of our products. We neither make warranties or representations with respect to the accuracy or completeness of the information contained in this datasheet nor grant any license to any intellectual property rights of ours or any third party concerning with the information in this datasheet.
3. Applicable export control laws and regulations should be complied and the procedures required by such laws and regulations should also be followed, when the product or any information contained in this datasheet is exported.
4. The product is neither intended nor warranted for use in equipment of systems which require extremely high levels of quality and/or reliability and/or a malfunction or failure which may cause loss of human life, bodily injury, serious property damage including but not limited to devices or equipment used in 1) nuclear facilities, 2) aerospace industry, 3) medical facilities, 4) automobile industry and other transportation industry and 5) safety devices and safety equipment to control combustions and explosions. Do not use the product for the above use unless agreed by us in writing in advance.
5. Although we make continuous efforts to improve the quality and reliability of our products; nevertheless Semiconductors are likely to fail with a certain probability. So in order to prevent personal injury and/or property damage resulting from such failure, customers are required to incorporate adequate safety measures in their designs, such as system fail safes, redundancy and fire prevention features.
6. Our products are not designed to be Radiation-resistant.
7. Please use the product listed in this datasheet within the specified ranges.
8. We assume no responsibility for damage or loss due to abnormal use.
9. All rights reserved. No part of this datasheet may be copied or reproduced unless agreed by Torex Semiconductor Ltd in writing in advance.

TOREX SEMICONDUCTOR LTD.

单击下面可查看定价，库存，交付和生命周期等信息

[>>Torex Semiconductor\(特瑞仕\)](#)