

TACT SWITCH

DTS(G)MW-6 SERIES

6x6 Gull-Wing SMT
Washable Type

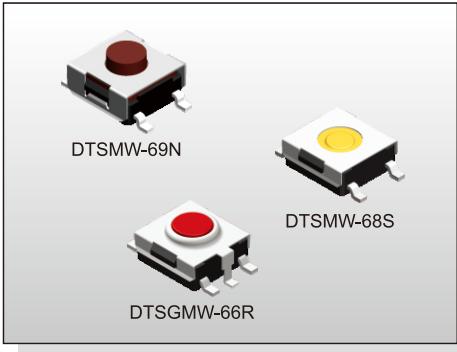

FEATURES

- ※Sealed
- ※Reflow solderable
- ※Dust proof with high reliability

APPLICATION

- ※Audio, OA equipment
- ※Instrumentation, Communication
- ※White goods

SPECIFICATION

Contact Rating	50mA, 12V DC
Contact Resistance	100mΩ max.
Insulation Resistance	100MΩ min. 500V DC
Dielectric Strength	250V AC/1 minute
Operating Force	160±50gf, Brown(N) 66/677 160±50gf, Silver(S) 68 180±50gf, Brown(N) 69/67/65/64 260±70gf, Red(R) 69/67/66/65/64 360±90gf, Transparent(T) 69/67/65/677
Travel	0.25mm 68S/66N/66R/677 0.45mm (69/67N,R)/(65/64N,R,T) 0.6mm 69/67T
Operating Life	100,000 cycles min. for 68/66/677 500,000 cycles min. for 69/67/65/64
Operating Temp.	-25°C ~ +70°C
Storage Temp.	-30°C ~ +80°C

HOW TO ORDER

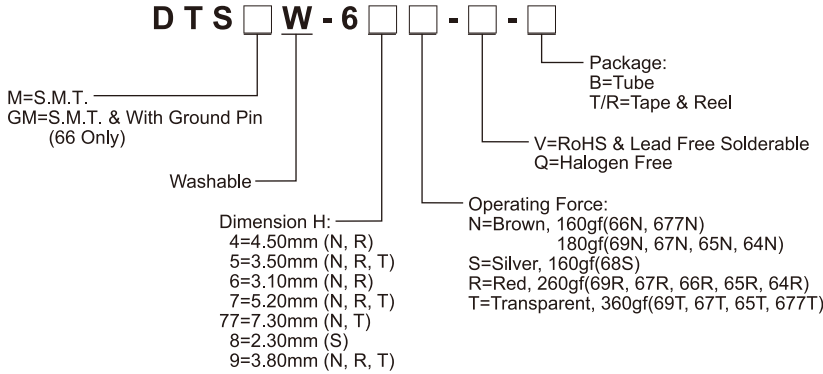

CIRCUIT

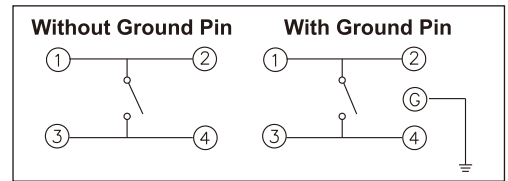

PACKAGE

- <Tube>**
75 pcs
- <Tape & Reel>**
DTSGMW-66: 2000 pcs
DTSMW-68, 66: 2000 pcs
DTSMW-69, 65: 1900 pcs
DTSMW-67, 64: 900 pcs
DTSMW-677: 650 pcs

DTSGMW-66

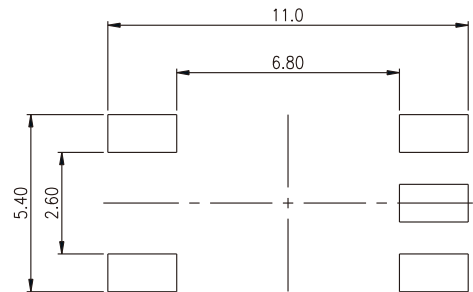
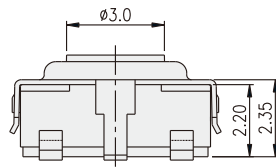
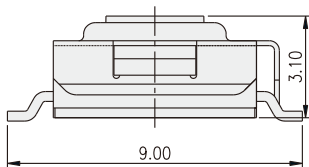
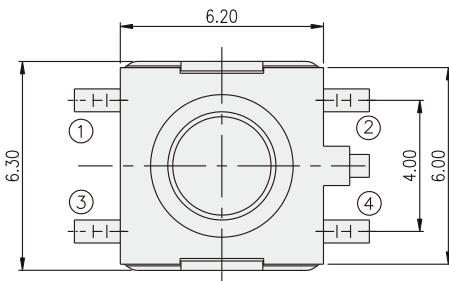

P.C.B. LAYOUT

TACT SWITCH

TACT SWITCH
DTS(G)MW-6 SERIES

6x6 Gull-Wing SMT
 Washable Type



DTSMW-68

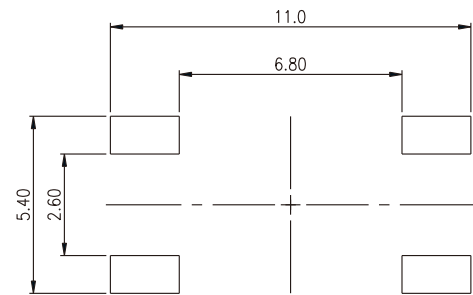
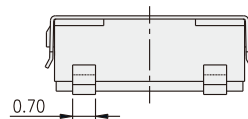
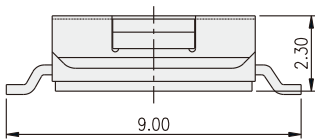
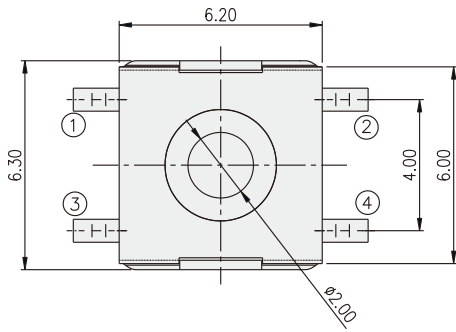

P.C.B. LAYOUT

TACT SWITCH

DTSMW-6 □

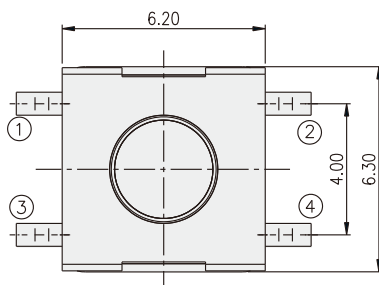

PART NO.	H
DTSMW-64	4.50
DTSMW-65	3.50
DTSMW-67	5.20
DTSMW-69	3.80
DTSMW-677	7.30

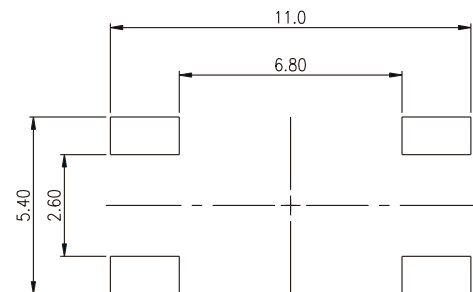
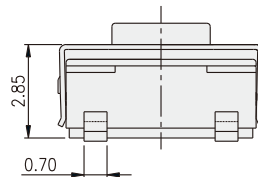
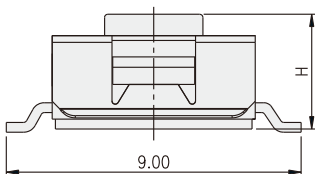

P.C.B. LAYOUT

单击下面可查看定价，库存，交付和生命周期等信息

[>>Diptronics\(圆达\)](#)