

TACT SWITCH TL(A)-A2 SERIES

10x10
High Reliability

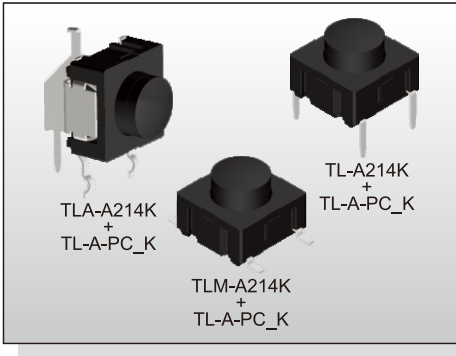

FEATURES

- ✳ Sealed
- ✳ Long life of 10million
- ✳ Variety of actuator lengths

APPLICATION

- ✳ Music instrument
- ✳ Intercom system
- ✳ Industrial

SPECIFICATION

Contact Rating	0.5~50mA, 24V DC
Contact Resistance	30mΩ max.
Insulation Resistance	10MΩ min. 100V DC
Dielectric Strength	250V AC/1 minute
Operating Force	300±75gf
Travel	1mm
Operating Life	10,000, 000 cycles
Operating Temp.	-40°C ~ +160°C
Storage Temp.	-40°C ~ +160°C

HOW TO ORDER

TL □ - A 2 1 4 K - Q - □ + TL - A - PC □ K

□=Through Hole
M=S.M.T.
A=Right Angle

Package:
B=Tube
(For Through Hole Type)
T/R=Tape & Reel(For S.M.T. Type)

Halogen Free

Button Color:
Black

Operating Force:
300gf

CIRCUIT

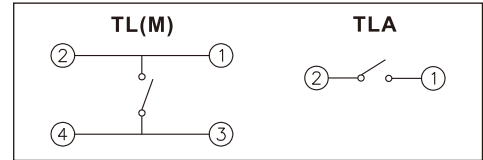

PACKAGE

<Tube>

TL(A): 45 pcs

<Tape & Reel>

TLM: 650 pcs

TACT SWITCH

TL-A214K+TL-A-PC□K

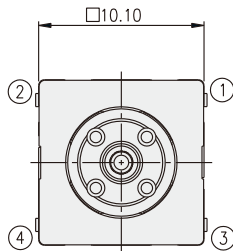

PART NO.	H
TL-A214K-Q-B+TL-A-PC1K	8.00
TL-A214K-Q-B+TL-A-PC2K	9.50
TL-A214K-Q-B+TL-A-PC3K	10.40
TL-A214K-Q-B+TL-A-PC4K	11.00
TL-A214K-Q-B+TL-A-PC5K	12.00
TL-A214K-Q-B+TL-A-PC6K	15.00

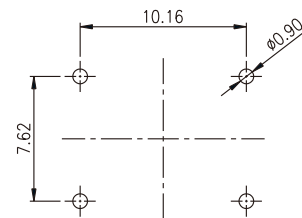
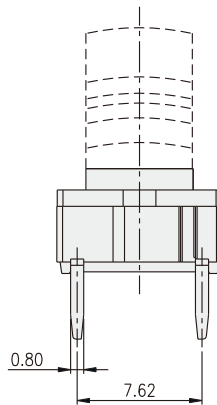
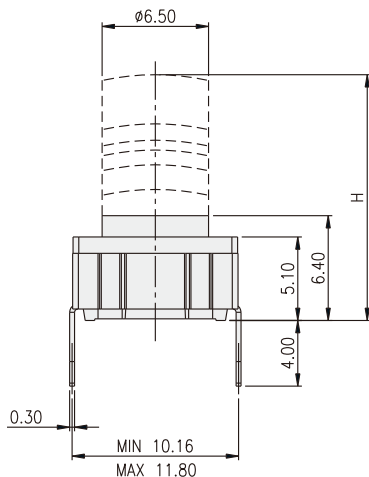

P.C.B. LAYOUT

TLM-A214K+TL-A-PC□K

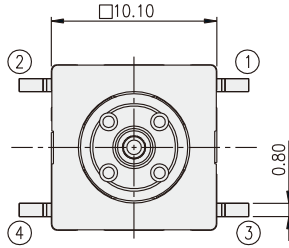

PART NO.	H
TLM-A214K-Q-B+TL-A-PC1K	8.00
TLM-A214K-Q-B+TL-A-PC2K	9.50
TLM-A214K-Q-B+TL-A-PC3K	10.40
TLM-A214K-Q-B+TL-A-PC4K	11.00
TLM-A214K-Q-B+TL-A-PC5K	12.00
TLM-A214K-Q-B+TL-A-PC6K	15.00

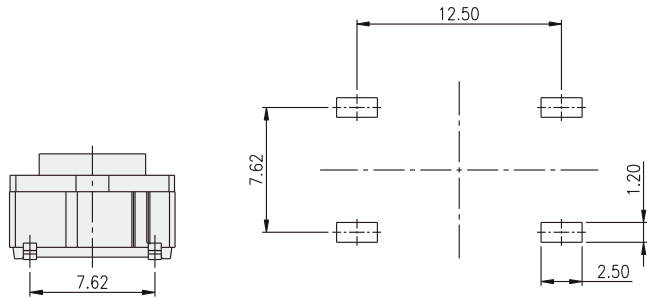
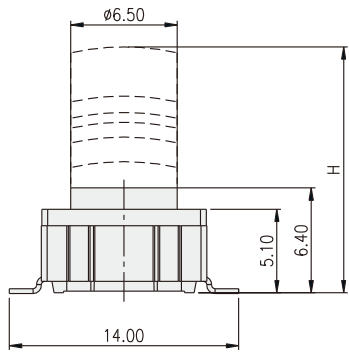

P.C.B. LAYOUT

TLA-A214K+TL-A-PC□K

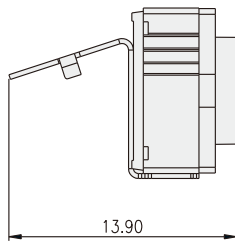

PART NO.	H
TLA-A214K-Q-B+TL-A-PC1K	8.00
TLA-A214K-Q-B+TL-A-PC2K	9.50
TLA-A214K-Q-B+TL-A-PC3K	10.40
TLA-A214K-Q-B+TL-A-PC4K	11.00
TLA-A214K-Q-B+TL-A-PC5K	12.00
TLA-A214K-Q-B+TL-A-PC6K	15.00

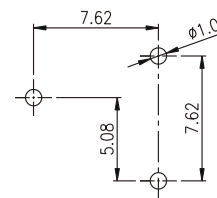
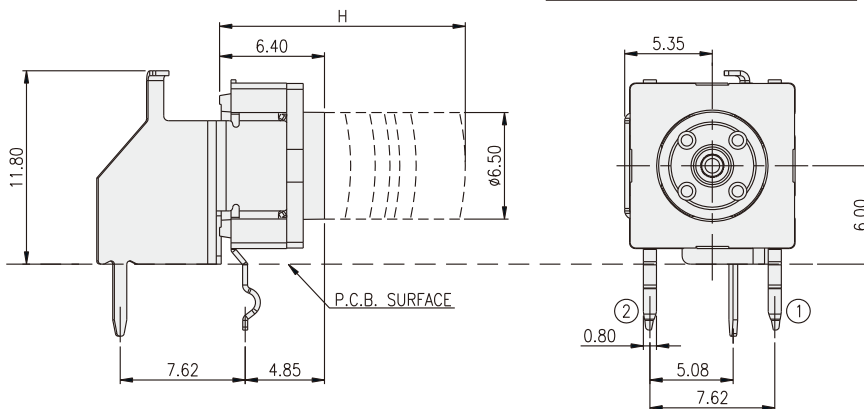

P.C.B. LAYOUT

单击下面可查看定价，库存，交付和生命周期等信息

[>>Diptronics\(圆达\)](#)