



# SGM2036

## 300mA, Low Power, Low Dropout, RF Linear Regulators

### GENERAL DESCRIPTION

The SGM2036 is a low noise, low voltage, high accuracy and low dropout voltage linear regulator. It is capable of supplying 300mA output current with typical dropout voltage of only 165mV. The operating input voltage range is from 1.6V to 5.5V. The output voltage range is from 0.8V to 5.0V in fixed output version. For adjustable output version, the output voltage can be adjusted from 0.8V to 5.0V by using external resistors.

Other features include logic-controlled shutdown mode, short-circuit current limit and thermal shutdown protection. The SGM2036 has automatic discharge function to quickly discharge  $V_{OUT}$  in the disabled status.

The SGM2036 is suitable for application which needs low noise and low dropout voltage, such as MP3 players, palmtop computers, etc. Fixed or adjustable output voltage versions are provided.

The SGM2036 is available in Green UTDFN-1×1-4L, SOT-23-5 and SC70-5 packages. It operates over an operating temperature range of -40°C to +85°C.

### FEATURES

- **Operating Input Voltage Range: 1.6V to 5.5V**
- **Fixed Output Voltages: 0.8V, 0.9V, 1.0V, 1.05V, 1.1V, 1.2V, 1.3V, 1.35V, 1.5V, 1.8V, 1.85V, 2.1V, 2.2V, 2.3V, 2.5V, 2.6V, 2.7V, 2.8V, 2.85V, 2.9V, 3.0V, 3.1V, 3.3V, 3.6V, 4.2V, 4.4V and 5.0V**
- **Adjustable Output from 0.8V to 5.0V**
- **300mA Guaranteed Output Current**
- **Output Voltage Accuracy:  $\pm 2.5\%$  at +25°C**
- **Low Dropout Voltage: 165mV (TYP) at 300mA**
- **Low Supply Current: 20 $\mu$ A (TYP)**
- **Shutdown Supply Current: 0.01 $\mu$ A (TYP)**
- **Short Start-Up Time**
- **Short Auto-Discharge Function**
- **Thermal Shutdown Protection**
- **Short-Circuit Current Limit**
- **-40°C to +85°C Operating Temperature Range**
- **Available in Green UTDFN-1×1-4L, SOT-23-5 and SC70-5 Packages**

### APPLICATIONS

Modems  
MP3 Players  
Cellular Telephones  
PCMCIA Cards  
Palmtop Computers  
Portable Electronics

## PACKAGE/ORDERING INFORMATION

MODEL	PACKAGE DESCRIPTION	SPECIFIED TEMPERATURE RANGE	ORDERING NUMBER	PACKAGE MARKING	PACKING OPTION
SGM2036-0.8	UTDFN-1×1-4L	-40°C to +85°C	SGM2036-0.8YUDH4G/TR	SF	Tape and Reel, 10000
SGM2036-0.9	UTDFN-1×1-4L	-40°C to +85°C	SGM2036-0.9YUDH4G/TR	NE	Tape and Reel, 10000
SGM2036-1.0	UTDFN-1×1-4L	-40°C to +85°C	SGM2036-1.0YUDH4G/TR	J3	Tape and Reel, 10000
SGM2036-1.05	UTDFN-1×1-4L	-40°C to +85°C	SGM2036-1.05YUDH4G/TR	NF	Tape and Reel, 10000
SGM2036-1.1	UTDFN-1×1-4L	-40°C to +85°C	SGM2036-1.1YUDH4G/TR	O0	Tape and Reel, 10000
SGM2036-1.2	UTDFN-1×1-4L	-40°C to +85°C	SGM2036-1.2YUDH4G/TR	HE	Tape and Reel, 10000
SGM2036-1.3	UTDFN-1×1-4L	-40°C to +85°C	SGM2036-1.3YUDH4G/TR	O1	Tape and Reel, 10000
SGM2036-1.35	UTDFN-1×1-4L	-40°C to +85°C	SGM2036-1.35YUDH4G/TR	Z7	Tape and Reel, 10000
SGM2036-1.5	UTDFN-1×1-4L	-40°C to +85°C	SGM2036-1.5YUDH4G/TR	HF	Tape and Reel, 10000
SGM2036-1.8	UTDFN-1×1-4L	-40°C to +85°C	SGM2036-1.8YUDH4G/TR	I0	Tape and Reel, 10000
SGM2036-1.85	UTDFN-1×1-4L	-40°C to +85°C	SGM2036-1.85YUDH4G/TR	O2	Tape and Reel, 10000
SGM2036-2.1	UTDFN-1×1-4L	-40°C to +85°C	SGM2036-2.1YUDH4G/TR	O3	Tape and Reel, 10000
SGM2036-2.2	UTDFN-1×1-4L	-40°C to +85°C	SGM2036-2.2YUDH4G/TR	O4	Tape and Reel, 10000
SGM2036-2.3	UTDFN-1×1-4L	-40°C to +85°C	SGM2036-2.3YUDH4G/TR	SA	Tape and Reel, 10000
SGM2036-2.5	UTDFN-1×1-4L	-40°C to +85°C	SGM2036-2.5YUDH4G/TR	O5	Tape and Reel, 10000
SGM2036-2.6	UTDFN-1×1-4L	-40°C to +85°C	SGM2036-2.6YUDH4G/TR	N6	Tape and Reel, 10000
SGM2036-2.7	UTDFN-1×1-4L	-40°C to +85°C	SGM2036-2.7YUDH4G/TR	O6	Tape and Reel, 10000
SGM2036-2.8	UTDFN-1×1-4L	-40°C to +85°C	SGM2036-2.8YUDH4G/TR	I1	Tape and Reel, 10000
SGM2036-2.85	UTDFN-1×1-4L	-40°C to +85°C	SGM2036-2.85YUDH4G/TR	O7	Tape and Reel, 10000
SGM2036-2.9	UTDFN-1×1-4L	-40°C to +85°C	SGM2036-2.9YUDH4G/TR	O8	Tape and Reel, 10000
SGM2036-3.0	UTDFN-1×1-4L	-40°C to +85°C	SGM2036-3.0YUDH4G/TR	I2	Tape and Reel, 10000
SGM2036-3.3	UTDFN-1×1-4L	-40°C to +85°C	SGM2036-3.3YUDH4G/TR	I3	Tape and Reel, 10000
SGM2036-0.8	SOT-23-5	-40°C to +85°C	SGM2036-0.8YN5G/TR	SS7XX	Tape and Reel, 3000
SGM2036-0.9	SOT-23-5	-40°C to +85°C	SGM2036-0.9YN5G/TR	SP0XX	Tape and Reel, 3000
SGM2036-1.0	SOT-23-5	-40°C to +85°C	SGM2036-1.0YN5G/TR	SP1XX	Tape and Reel, 3000
SGM2036-1.05	SOT-23-5	-40°C to +85°C	SGM2036-1.05YN5G/TR	SP2XX	Tape and Reel, 3000
SGM2036-1.1	SOT-23-5	-40°C to +85°C	SGM2036-1.1YN5G/TR	SP3XX	Tape and Reel, 3000
SGM2036-1.2	SOT-23-5	-40°C to +85°C	SGM2036-1.2YN5G/TR	SP4XX	Tape and Reel, 3000
SGM2036-1.3	SOT-23-5	-40°C to +85°C	SGM2036-1.3YN5G/TR	SP5XX	Tape and Reel, 3000
SGM2036-1.5	SOT-23-5	-40°C to +85°C	SGM2036-1.5YN5G/TR	SP6XX	Tape and Reel, 3000
SGM2036-1.8	SOT-23-5	-40°C to +85°C	SGM2036-1.8YN5G/TR	SP7XX	Tape and Reel, 3000
SGM2036-1.85	SOT-23-5	-40°C to +85°C	SGM2036-1.85YN5G/TR	SP8XX	Tape and Reel, 3000
SGM2036-2.1	SOT-23-5	-40°C to +85°C	SGM2036-2.1YN5G/TR	SP9XX	Tape and Reel, 3000
SGM2036-2.2	SOT-23-5	-40°C to +85°C	SGM2036-2.2YN5G/TR	SPAXX	Tape and Reel, 3000
SGM2036-2.3	SOT-23-5	-40°C to +85°C	SGM2036-2.3YN5G/TR	SS9XX	Tape and Reel, 3000
SGM2036-2.5	SOT-23-5	-40°C to +85°C	SGM2036-2.5YN5G/TR	SPBXX	Tape and Reel, 3000
SGM2036-2.6	SOT-23-5	-40°C to +85°C	SGM2036-2.6YN5G/TR	SN5XX	Tape and Reel, 3000
SGM2036-2.7	SOT-23-5	-40°C to +85°C	SGM2036-2.7YN5G/TR	SPCXX	Tape and Reel, 3000
SGM2036-2.8	SOT-23-5	-40°C to +85°C	SGM2036-2.8YN5G/TR	SPDXX	Tape and Reel, 3000
SGM2036-2.85	SOT-23-5	-40°C to +85°C	SGM2036-2.85YN5G/TR	SPEXX	Tape and Reel, 3000
SGM2036-2.9	SOT-23-5	-40°C to +85°C	SGM2036-2.9YN5G/TR	SPFXX	Tape and Reel, 3000

**PACKAGE/ORDERING INFORMATION (continued)**

MODEL	PACKAGE DESCRIPTION	SPECIFIED TEMPERATURE RANGE	ORDERING NUMBER	PACKAGE MARKING	PACKING OPTION
SGM2036-3.0	SOT-23-5	-40°C to +85°C	SGM2036-3.0YN5G/TR	SQ0XX	Tape and Reel, 3000
SGM2036-3.1	SOT-23-5	-40°C to +85°C	SGM2036-3.1YN5G/TR	SQ1XX	Tape and Reel, 3000
SGM2036-3.3	SOT-23-5	-40°C to +85°C	SGM2036-3.3YN5G/TR	SQ2XX	Tape and Reel, 3000
SGM2036-3.6	SOT-23-5	-40°C to +85°C	SGM2036-3.6YN5G/TR	SQ3XX	Tape and Reel, 3000
SGM2036-4.2	SOT-23-5	-40°C to +85°C	SGM2036-4.2YN5G/TR	SQ4XX	Tape and Reel, 3000
SGM2036-4.4	SOT-23-5	-40°C to +85°C	SGM2036-4.4YN5G/TR	SQ5XX	Tape and Reel, 3000
SGM2036-5.0	SOT-23-5	-40°C to +85°C	SGM2036-5.0YN5G/TR	SQ6XX	Tape and Reel, 3000
SGM2036-ADJ	SOT-23-5	-40°C to +85°C	SGM2036-ADJYN5G/TR	SQ7XX	Tape and Reel, 3000
SGM2036-0.8	SC70-5	-40°C to +85°C	SGM2036-0.8YC5G/TR	SSBXX	Tape and Reel, 3000
SGM2036-0.9	SC70-5	-40°C to +85°C	SGM2036-0.9YC5G/TR	SQ8XX	Tape and Reel, 3000
SGM2036-1.0	SC70-5	-40°C to +85°C	SGM2036-1.0YC5G/TR	SQ9XX	Tape and Reel, 3000
SGM2036-1.05	SC70-5	-40°C to +85°C	SGM2036-1.05YC5G/TR	SQAXX	Tape and Reel, 3000
SGM2036-1.1	SC70-5	-40°C to +85°C	SGM2036-1.1YC5G/TR	SQBXX	Tape and Reel, 3000
SGM2036-1.2	SC70-5	-40°C to +85°C	SGM2036-1.2YC5G/TR	SQCXX	Tape and Reel, 3000
SGM2036-1.3	SC70-5	-40°C to +85°C	SGM2036-1.3YC5G/TR	SQDXX	Tape and Reel, 3000
SGM2036-1.5	SC70-5	-40°C to +85°C	SGM2036-1.5YC5G/TR	SQEXX	Tape and Reel, 3000
SGM2036-1.8	SC70-5	-40°C to +85°C	SGM2036-1.8YC5G/TR	SQFXX	Tape and Reel, 3000
SGM2036-1.85	SC70-5	-40°C to +85°C	SGM2036-1.85YC5G/TR	SR0XX	Tape and Reel, 3000
SGM2036-2.1	SC70-5	-40°C to +85°C	SGM2036-2.1YC5G/TR	SR1XX	Tape and Reel, 3000
SGM2036-2.2	SC70-5	-40°C to +85°C	SGM2036-2.2YC5G/TR	SR2XX	Tape and Reel, 3000
SGM2036-2.3	SC70-5	-40°C to +85°C	SGM2036-2.3YC5G/TR	SS8XX	Tape and Reel, 3000
SGM2036-2.5	SC70-5	-40°C to +85°C	SGM2036-2.5YC5G/TR	SR3XX	Tape and Reel, 3000
SGM2036-2.6	SC70-5	-40°C to +85°C	SGM2036-2.6YC5G/TR	SN4XX	Tape and Reel, 3000
SGM2036-2.7	SC70-5	-40°C to +85°C	SGM2036-2.7YC5G/TR	SR4XX	Tape and Reel, 3000
SGM2036-2.8	SC70-5	-40°C to +85°C	SGM2036-2.8YC5G/TR	SR5XX	Tape and Reel, 3000
SGM2036-2.85	SC70-5	-40°C to +85°C	SGM2036-2.85YC5G/TR	SR6XX	Tape and Reel, 3000
SGM2036-2.9	SC70-5	-40°C to +85°C	SGM2036-2.9YC5G/TR	SR7XX	Tape and Reel, 3000
SGM2036-3.0	SC70-5	-40°C to +85°C	SGM2036-3.0YC5G/TR	SR8XX	Tape and Reel, 3000
SGM2036-3.1	SC70-5	-40°C to +85°C	SGM2036-3.1YC5G/TR	SR9XX	Tape and Reel, 3000
SGM2036-3.3	SC70-5	-40°C to +85°C	SGM2036-3.3YC5G/TR	SRAXX	Tape and Reel, 3000
SGM2036-3.6	SC70-5	-40°C to +85°C	SGM2036-3.6YC5G/TR	SRBXX	Tape and Reel, 3000
SGM2036-4.2	SC70-5	-40°C to +85°C	SGM2036-4.2YC5G/TR	SRCXX	Tape and Reel, 3000
SGM2036-4.4	SC70-5	-40°C to +85°C	SGM2036-4.4YC5G/TR	SRDXX	Tape and Reel, 3000
SGM2036-5.0	SC70-5	-40°C to +85°C	SGM2036-5.0YC5G/TR	SREXX	Tape and Reel, 3000
SGM2036-ADJ	SC70-5	-40°C to +85°C	SGM2036-ADJYC5G/TR	SRFXX	Tape and Reel, 3000

**MARKING INFORMATION**

NOTE: XX = Date Code.

**UTDFN-1×1-4L**

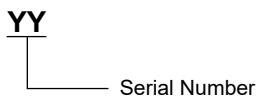

**SOT-23-5/SC70-5**

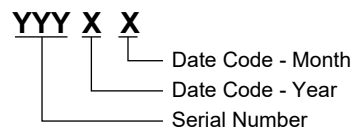

Green (RoHS & HSF): SG Micro Corp defines "Green" to mean Pb-Free (RoHS compatible) and free of halogen substances. If you have additional comments or questions, please contact your SGMICRO representative directly.

**ABSOLUTE MAXIMUM RATINGS**

IN to GND .....	-0.3V to 6V
Output Short-Circuit Duration.....	Infinite
EN to GND.....	-0.3V to 6V
OUT, BP/FB to GND .....	-0.3V to (V <sub>IN</sub> + 0.3V)
Power Dissipation, P <sub>D</sub> @ T <sub>A</sub> = +25°C	
UTDFN-1×1-4L .....	400mW
SOT-23-5.....	390mW
SC70-5.....	340mW
Package Thermal Resistance	
UTDFN-1×1-4L, θ <sub>JA</sub> .....	280°C/W
SOT-23-5, θ <sub>JA</sub> .....	285°C/W
SC70-5, θ <sub>JA</sub> .....	330°C/W
Junction Temperature .....	+150°C
Storage Temperature Range.....	-65°C to +150°C
Lead Temperature (Soldering, 10s) .....	+260°C
ESD Susceptibility	
HBM.....	4000V
MM.....	400V

**RECOMMENDED OPERATING CONDITIONS**

Operating Voltage Range.....	1.6V to 5.5V
Enable Input Voltage Range .....	0V to 5.5V
Input Effective Capacitance, C <sub>IN</sub> .....	0.1µF (MIN)
Output Effective Capacitance, C <sub>OUT</sub> .....	0.5µF to 10µF
Operating Temperature Range .....	-40°C to +85°C

**OVERSTRESS CAUTION**

Stresses beyond those listed in Absolute Maximum Ratings may cause permanent damage to the device. Exposure to absolute maximum rating conditions for extended periods may affect reliability. Functional operation of the device at any conditions beyond those indicated in the Recommended Operating Conditions section is not implied.

**ESD SENSITIVITY CAUTION**

This integrated circuit can be damaged if ESD protections are not considered carefully. SGMICRO recommends that all integrated circuits be handled with appropriate precautions. Failure to observe proper handling and installation procedures can cause damage. ESD damage can range from subtle performance degradation to complete device failure. Precision integrated circuits may be more susceptible to damage because even small parametric changes could cause the device not to meet the published specifications.

**DISCLAIMER**

SG Micro Corp reserves the right to make any change in circuit design, or specifications without prior notice.

PIN CONFIGURATIONS

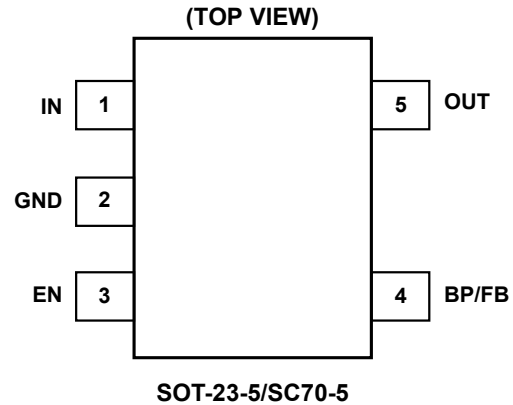
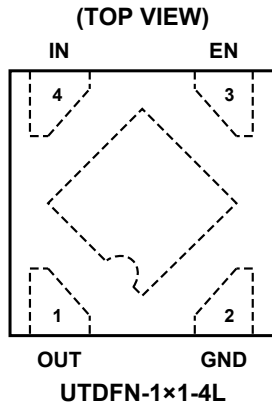

PIN DESCRIPTION

PIN		NAME	FUNCTION
UTDNF-1x1-4L	SOT-23-5/ SC70-5		
1	5	OUT	Regulator Output Pin. It is recommended to use an output capacitor with effective capacitance of 1μF. The capacitor should be located very close to this pin..
2	2	GND	Ground.
3	3	EN	Enable Pin. Drive EN high to turn on the regulator. Drive EN low to turn off the regulator. This pin has an internal pull-down resistor and must be connected to IN pin if enable functionality is not used.
4	1	IN	Input Voltage Supply Pin. It is recommended to use a 1μF or larger ceramic capacitor from IN pin to ground.
-	4	BP	Reference-Noise Bypass Pin (fixed voltage version only). Bypass with an external capacitor C <sub>BP</sub> can reduce output noise to very low level. The capacitor is recommended to be placed very close to the pin for high PSRR.
		FB	Feedback Voltage Input Pin (adjustable voltage version only). Connect this pin to the external resistor divider to adjust the output voltage.
Exposed Pad	-	-	Exposed Pad. Exposed pad is internally connected to GND. Connect it to a large ground plane to maximize thermal performance; not intended as an electrical connection point.

**ELECTRICAL CHARACTERISTICS**

(V<sub>IN</sub> = V<sub>OUT (NOMINAL)</sub> + 0.5V or 2.5V, whichever is greater, Full = -40°C to +85°C, unless otherwise noted.)

PARAMETER	SYMBOL	CONDITIONS	TEMP	MIN	TYP	MAX	UNITS	
Input Voltage	V <sub>IN</sub>		+25°C	1.6		5.5	V	
Output Voltage Accuracy		I <sub>OUT</sub> = 0.1mA	+25°C	-2.5		+2.5	%	
Feedback Voltage	V <sub>FB</sub>	I <sub>OUT</sub> = 0.1mA, SGM2036-ADJ	+25°C	0.78	0.8	0.82	V	
Maximum Output Current <sup>(1)</sup>			+25°C	300			mA	
Current Limit	I <sub>LIM</sub>		+25°C	360	560		mA	
Supply Pin Current	I <sub>Q</sub>	No Load, V <sub>EN</sub> = V <sub>IN</sub>	+25°C		20	26	μA	
Dropout Voltage <sup>(2)</sup>	V <sub>DROP</sub>	I <sub>OUT</sub> = 300mA	V <sub>OUT</sub> = 0.8V	+25°C		940	1200	mV
			V <sub>OUT</sub> = 0.9V	+25°C		840	1100	
			1.0V ≤ V <sub>OUT</sub> < 1.1V	+25°C		780	1000	
			1.1V ≤ V <sub>OUT</sub> < 1.2V	+25°C		680	900	
			1.2V ≤ V <sub>OUT</sub> < 1.5V	+25°C		590	800	
			1.5V ≤ V <sub>OUT</sub> < 1.8V	+25°C		420	550	
			1.8V ≤ V <sub>OUT</sub> < 2.1V	+25°C		320	420	
			2.1V ≤ V <sub>OUT</sub> < 2.5V	+25°C		260	340	
			2.5V ≤ V <sub>OUT</sub> < 3.0V	+25°C		215	280	
			3.0V ≤ V <sub>OUT</sub> < 3.6V	+25°C		190	250	
		3.6V ≤ V <sub>OUT</sub> ≤ 5.0V	+25°C		165	210		
Line Regulation	$\frac{\Delta V_{OUT}}{\Delta V_{IN} \times V_{OUT}}$	V <sub>IN</sub> = 1.6V or (V <sub>OUT</sub> + 0.5V) to 5.5V, I <sub>OUT</sub> = 1mA	1.8V ≤ V <sub>OUT</sub> ≤ 3.3V	+25°C		0.01	0.06	%V
			V <sub>OUT</sub> < 1.8V or V <sub>OUT</sub> > 3.3V	+25°C		0.01	0.1	
Load Regulation	ΔV <sub>OUT</sub>	I <sub>OUT</sub> = 0.1mA to 300mA	+25°C		12	40	mV	
		I <sub>OUT</sub> = 0.1mA to 300mA, SGM2036-ADJ	+25°C		0.5	10		
Short Current Limit	I <sub>SHORT</sub>	V <sub>OUT</sub> = 0V	+25°C		200		mA	
Power Supply Rejection Ratio	PSRR	C <sub>BP</sub> = 0μF, I <sub>OUT</sub> = 30mA, C <sub>OUT</sub> = 1μF, V <sub>IN</sub> = V <sub>OUT</sub> + 1V, ΔV <sub>RIPPLE</sub> = 0.2V <sub>P-P</sub>	f = 217Hz	+25°C		80	dB	
			f = 1kHz	+25°C		75		
			C <sub>BP</sub> = 0.01μF, I <sub>OUT</sub> = 30mA, C <sub>OUT</sub> = 1μF, V <sub>IN</sub> = V <sub>OUT</sub> + 1V, ΔV <sub>RIPPLE</sub> = 0.2V <sub>P-P</sub>	f = 217Hz	+25°C			82
			f = 1kHz	+25°C		70		
Output Voltage Noise	e <sub>n</sub>	C <sub>BP</sub> = 0μF, f = 10Hz to 100kHz, C <sub>OUT</sub> = 1μF, V <sub>OUT</sub> = 1.8V	I <sub>OUT</sub> = 0mA	+25°C		100	μV <sub>RMS</sub>	
			I <sub>OUT</sub> = 30mA	+25°C		200		
			C <sub>BP</sub> = 0.01μF, f = 10Hz to 100kHz, C <sub>OUT</sub> = 1μF, V <sub>OUT</sub> = 1.8V	I <sub>OUT</sub> = 0mA	+25°C			30
			I <sub>OUT</sub> = 30mA	+25°C		75		
Output Voltage Temperature Coefficient <sup>(3)</sup>	$\frac{\Delta V_{OUT}}{\Delta T_A \times V_{OUT}}$	I <sub>OUT</sub> = 0.1mA	Full		30		ppm/°C	
<b>Shutdown</b>								
EN Input Threshold	V <sub>IH</sub>	V <sub>IN</sub> = 1.6V to 5.5V	Full	1.5			V	
	V <sub>IL</sub>		Full			0.4		
EN Input Bias Current	I <sub>BH</sub>	V <sub>EN</sub> = 5.5V	Full		0.8	2	μA	
	I <sub>BL</sub>	V <sub>EN</sub> = 0V	Full		0.01	1		
Shutdown Supply Current	I <sub>SHDN</sub>	V <sub>EN</sub> = 0V	Full		0.01	1	μA	
Start-Up Time <sup>(4)</sup>	t <sub>STR</sub>	C <sub>OUT</sub> = 1μF, No Load	+25°C		30		μs	
R <sub>ON</sub> of Discharge MOSFET		V <sub>IN</sub> = 4.0V, V <sub>EN</sub> = 0V	+25°C		50		Ω	

**ELECTRICAL CHARACTERISTICS (continued)**(V<sub>IN</sub> = V<sub>OUT (NOMINAL)</sub> + 0.5V or 2.5V, whichever is greater, Full = -40°C to +85°C, unless otherwise noted.)

PARAMETER	SYMBOL	CONDITIONS	MIN	TYP	MAX	UNITS
<b>Thermal Protection</b>						
Thermal Shutdown Temperature	T <sub>SHDN</sub>			140		°C
Thermal Shutdown Hysteresis	ΔT <sub>SHDN</sub>			15		°C

## NOTES:

1. Maximum output current is affected by the PCB layout, size of metal trace, the thermal conduction path between metal layers, ambient temperature and the other environment factors of system. Attention should be paid to the dropout voltage when V<sub>IN</sub> < V<sub>OUT</sub> + V<sub>DROP</sub>.
2. The dropout voltage is defined as V<sub>IN</sub> - V<sub>OUT</sub>, when V<sub>OUT</sub> is 100mV below the value of V<sub>OUT</sub> for V<sub>IN</sub> = V<sub>OUT</sub> + 0.5V or 2.5V.
3. Output voltage temperature coefficient is defined as the worst-case voltage change divided by the total temperature range.
4. Time needed for V<sub>OUT</sub> to reach 90% of final value.

TYPICAL APPLICATION CIRCUITS

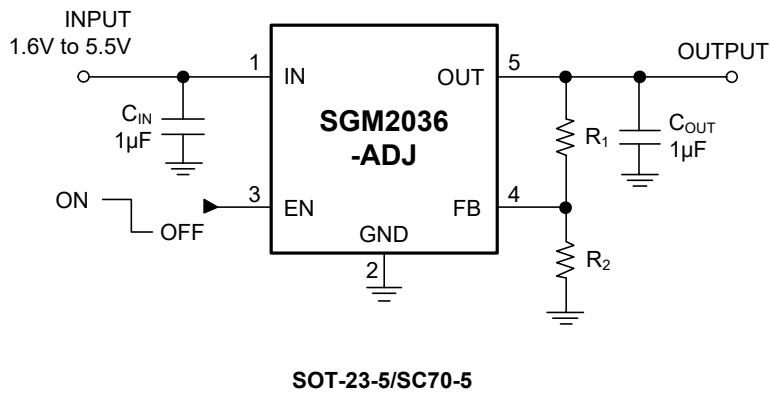
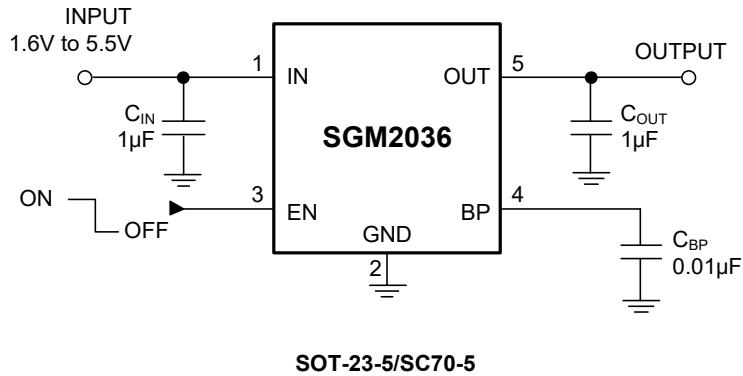

NOTE: Choose  $R_2 = 160k\Omega$  to maintain a  $5\mu A$  minimum load. Calculate the value for  $R_1$  using the following equation:

$$R_1 = R_2 \times \left( \frac{V_{OUT}}{0.8V} - 1 \right)$$

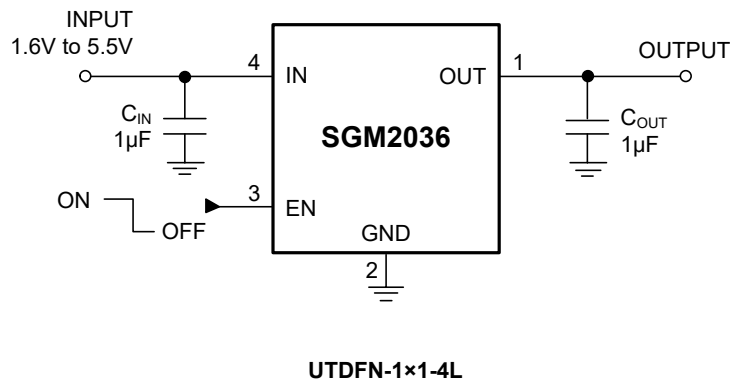



TYPICAL PERFORMANCE CHARACTERISTICS

$T_A = +25^\circ\text{C}$ ,  $V_{EN} = V_{IN}$ ,  $C_{IN} = 1\mu\text{F}$ ,  $C_{OUT} = 1\mu\text{F}$ ,  $C_{BP} = 0\mu\text{F}$ , unless otherwise noted.

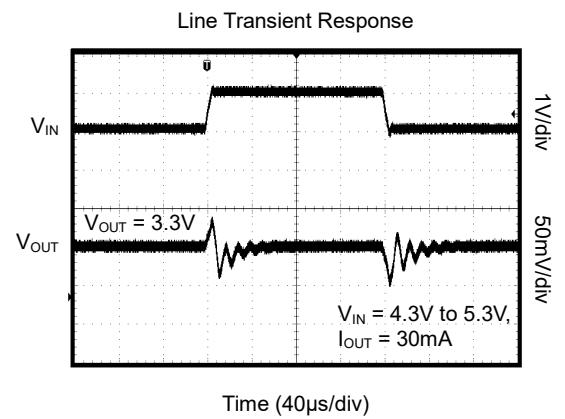
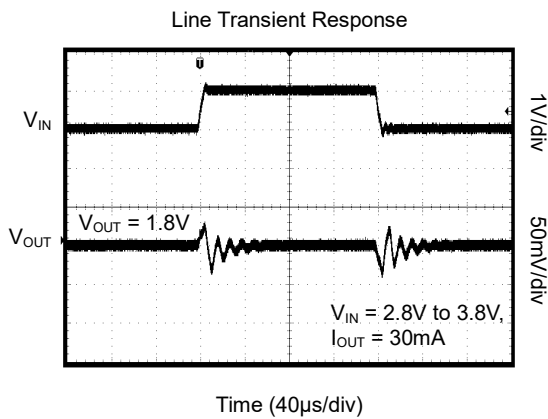
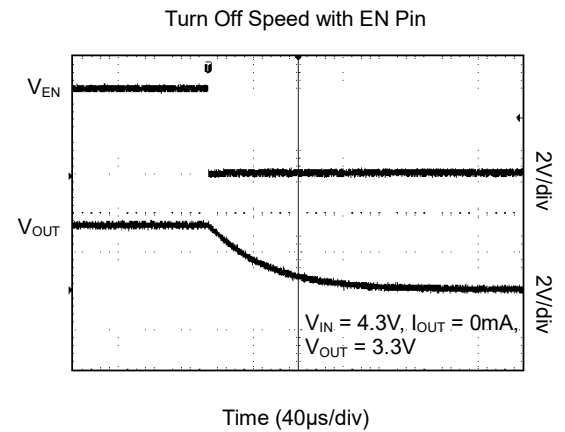
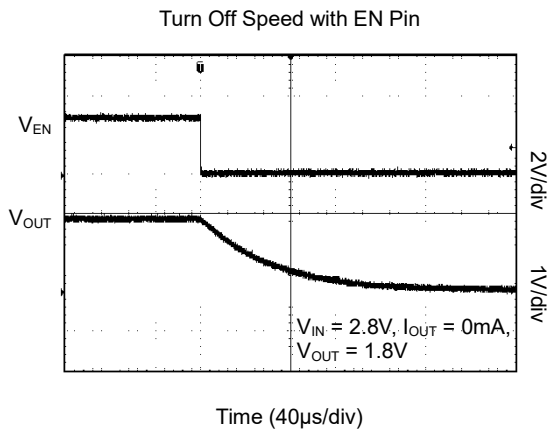
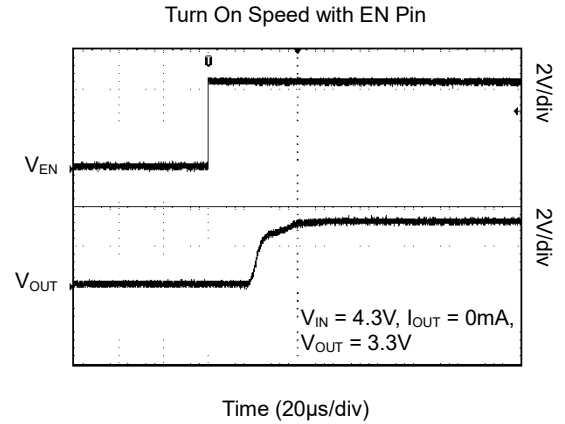
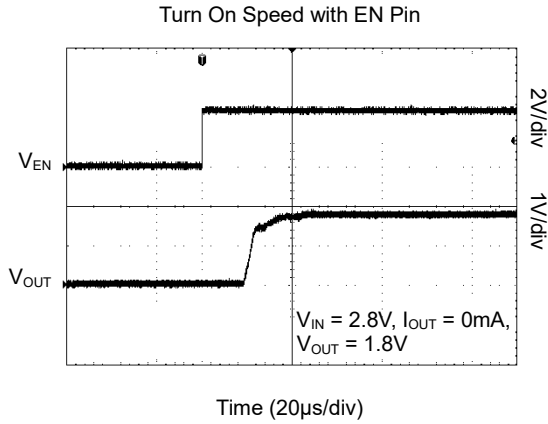

TYPICAL PERFORMANCE CHARACTERISTICS (continued)

T<sub>A</sub> = +25°C, V<sub>EN</sub> = V<sub>IN</sub>, C<sub>IN</sub> = 1μF, C<sub>OUT</sub> = 1μF, C<sub>BP</sub> = 0μF, unless otherwise noted.

Load Transient Response

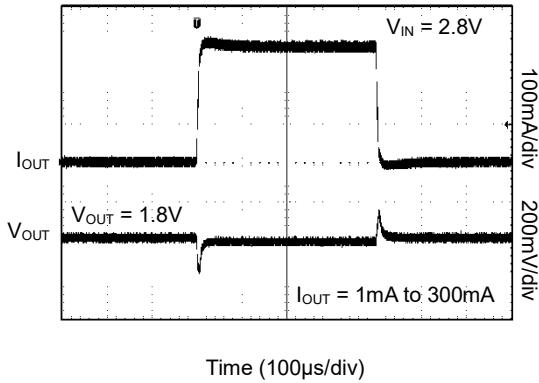

Load Transient Response

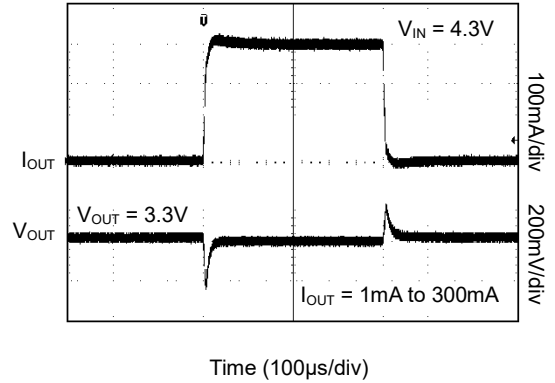

Load Transient Response

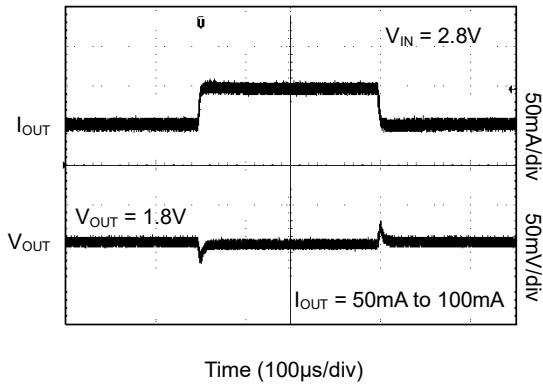

Load Transient Response

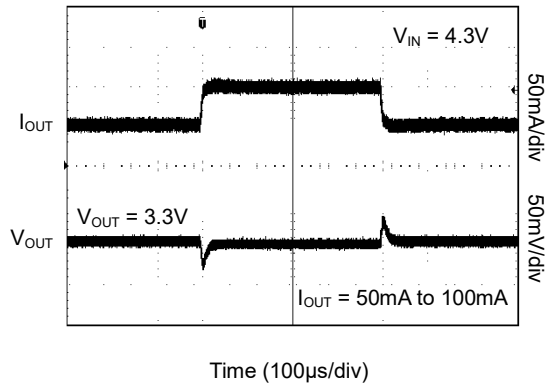

Power Supply Rejection Ratio vs. Frequency

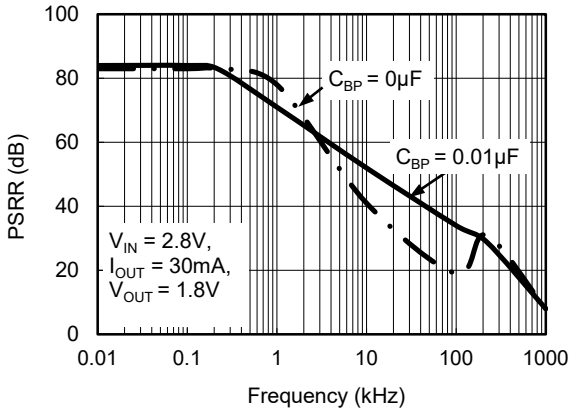

Power Supply Rejection Ratio vs. Frequency

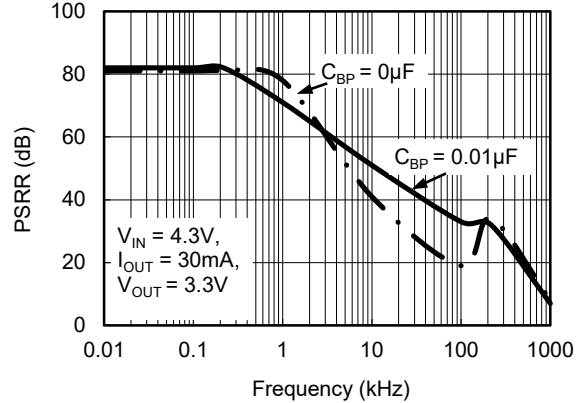

TYPICAL PERFORMANCE CHARACTERISTICS (continued)

$T_A = +25^\circ\text{C}$ ,  $V_{EN} = V_{IN}$ ,  $C_{IN} = 1\mu\text{F}$ ,  $C_{OUT} = 1\mu\text{F}$ ,  $C_{BP} = 0\mu\text{F}$ , unless otherwise noted.

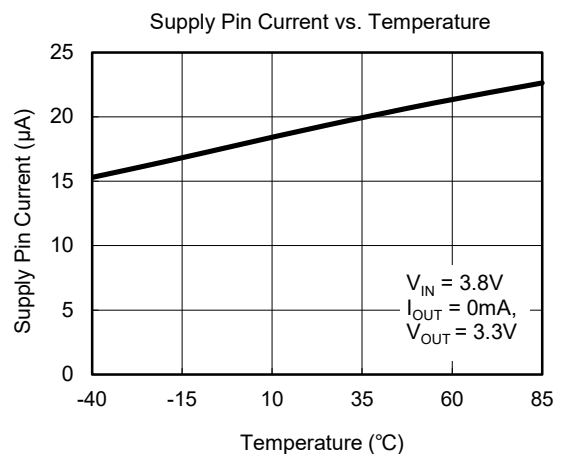
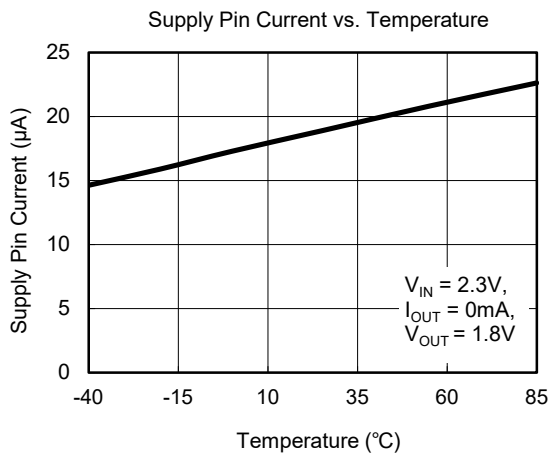
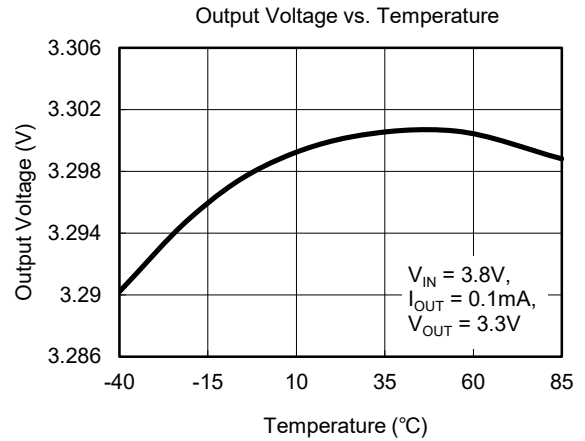
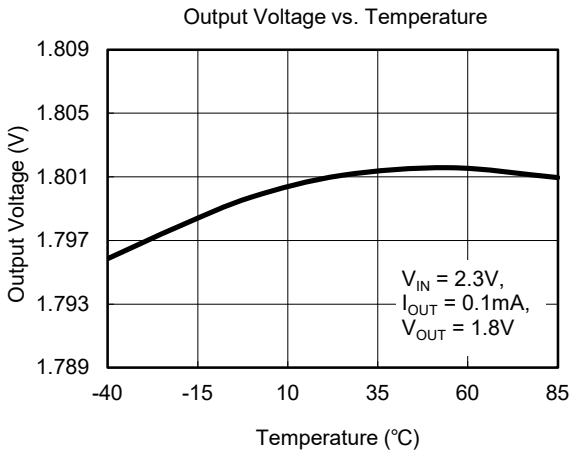
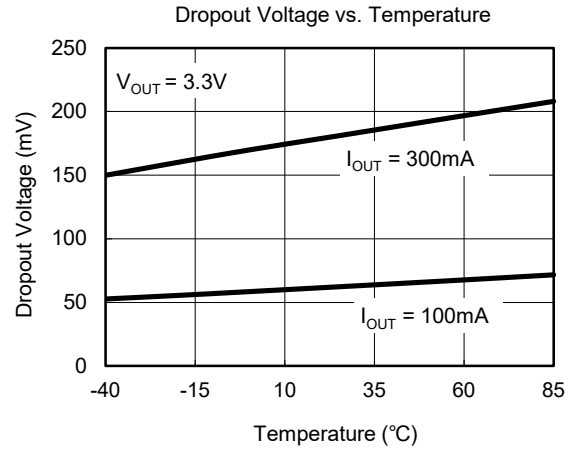
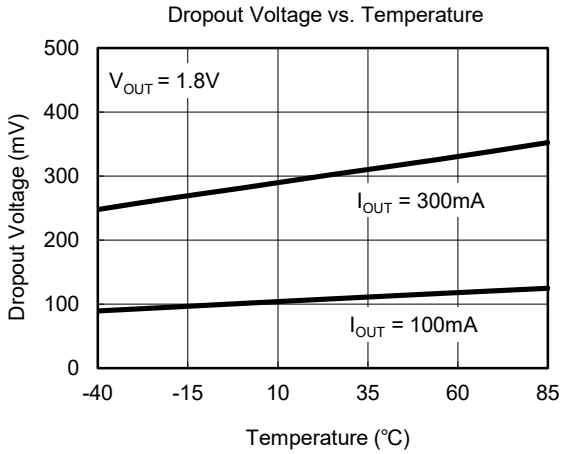

TYPICAL PERFORMANCE CHARACTERISTICS (continued)

T<sub>A</sub> = +25°C, V<sub>EN</sub> = V<sub>IN</sub>, C<sub>IN</sub> = 1μF, C<sub>OUT</sub> = 1μF, C<sub>BP</sub> = 0μF, unless otherwise noted.

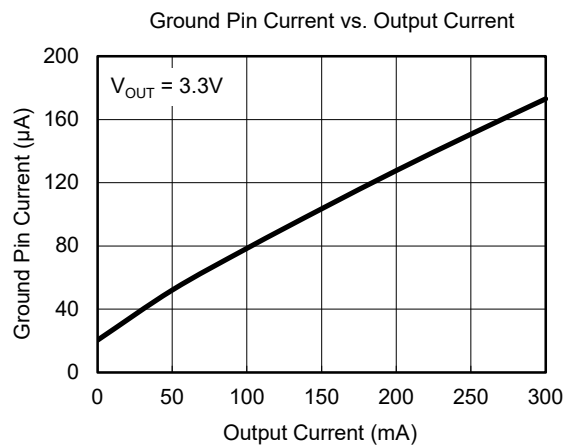
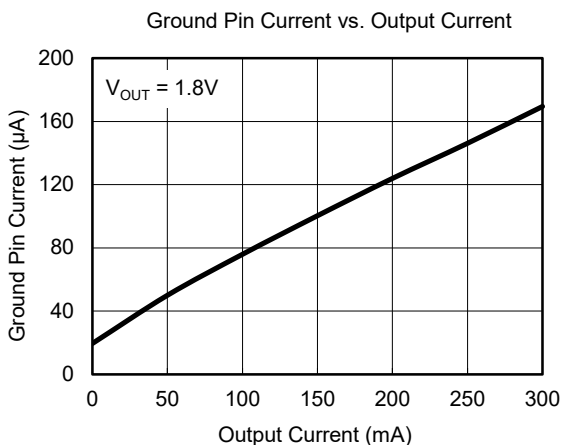
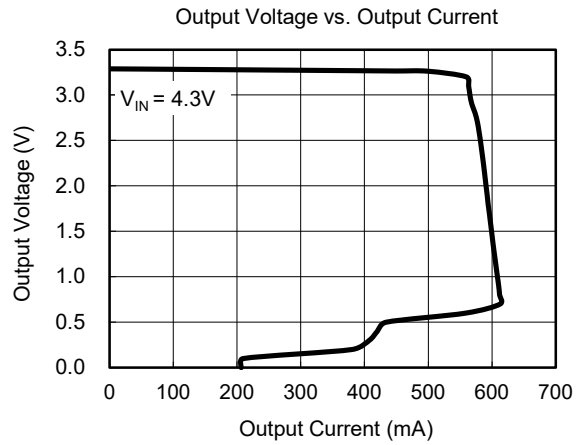
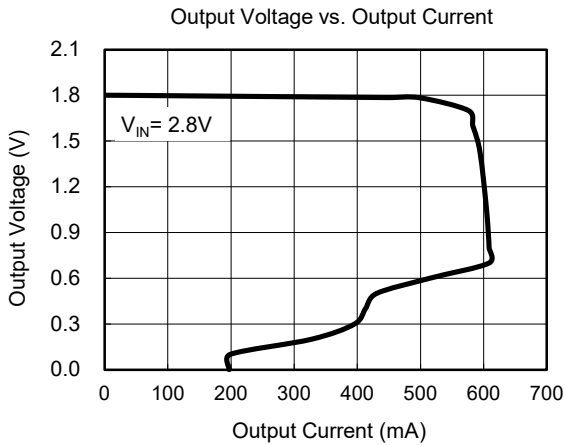
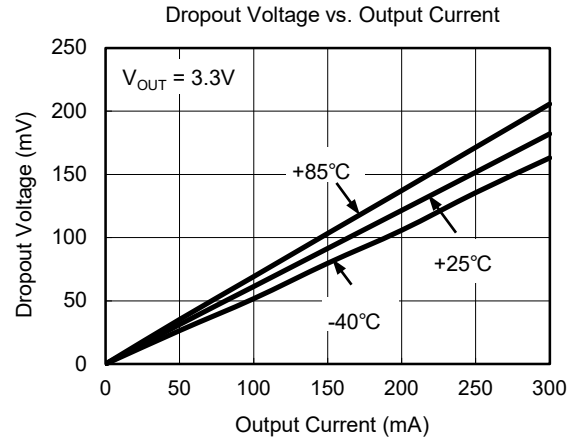
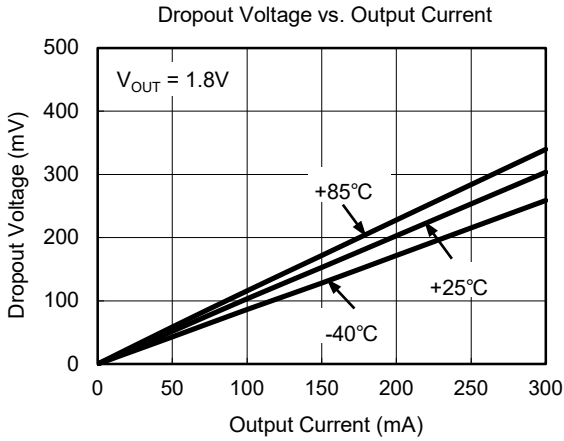

TYPICAL PERFORMANCE CHARACTERISTICS (continued)

T<sub>A</sub> = +25°C, V<sub>EN</sub> = V<sub>IN</sub>, C<sub>IN</sub> = 1µF, C<sub>OUT</sub> = 1µF, C<sub>BP</sub> = 0µF, unless otherwise noted.

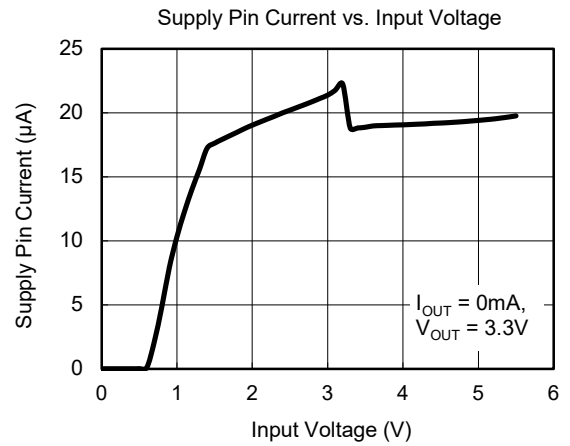
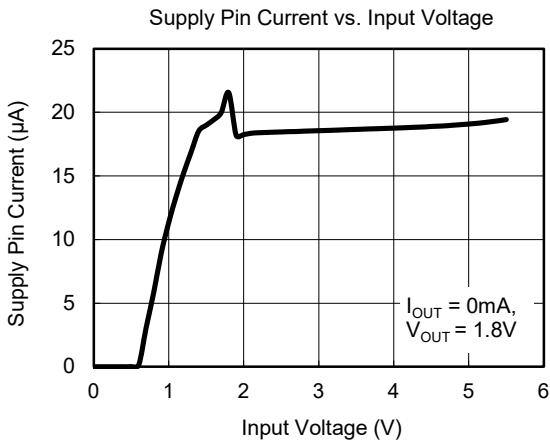
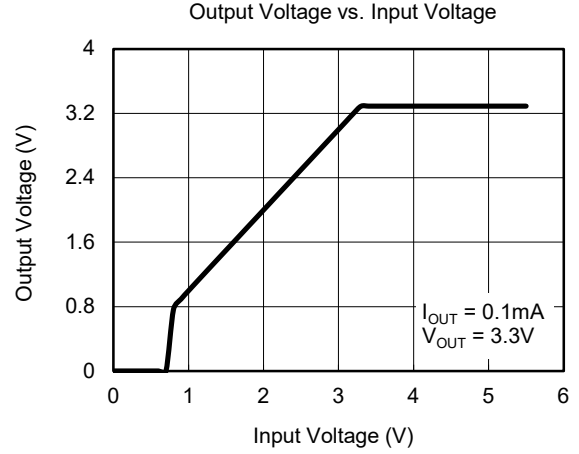
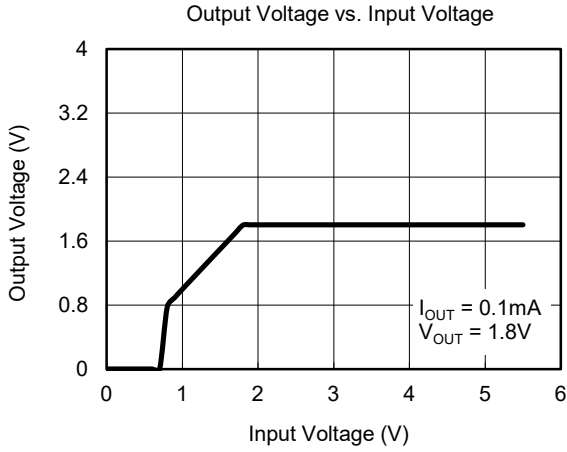

**REVISION HISTORY**

NOTE: Page numbers for previous revisions may differ from page numbers in the current version.

<b>NOVEMBER 2021 – REV.B.1 to REV.B.2</b>	<b>Page</b>
Updated Recommended Operating Conditions section .....	4
Updated Package Outline Dimensions section .....	16
<b>NOVEMBER 2017 – REV.B to REV.B.1</b>	<b>Page</b>
Updated Package/Ordering Information section .....	2-4
<b>DECEMBER 2015 – REV.A.4 to REV.B</b>	<b>Page</b>
Added output voltage temperature coefficient .....	7
<b>NOVEMBER 2015 – REV.A.3 to REV.A.4</b>	<b>Page</b>
Updated package name .....	6
<b>APRIL 2015 – REV.A.2 to REV.A.3</b>	<b>Page</b>
Added SC70-5 package .....	All
<b>NOVEMBER 2014 – REV.A.1 to REV.A.2</b>	<b>Page</b>
Added SGM2036-1.35YUDH4G version .....	1-3
<b>SEPTEMBER 2014 – REV.A to REV.A.1</b>	<b>Page</b>
Added load regulation maximum value .....	7
<b>Changes from Original (JUNE 2014) to REV.A</b>	<b>Page</b>
Changed from product preview to production data .....	All

PACKAGE OUTLINE DIMENSIONS

SC70-5

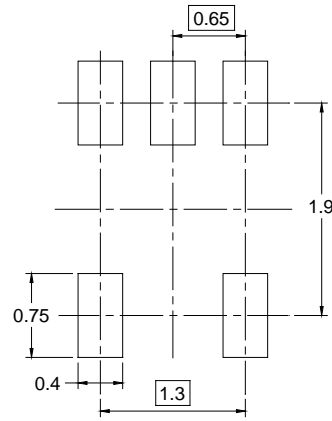
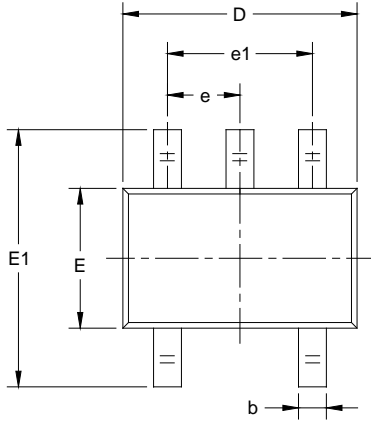

RECOMMENDED LAND PATTERN (Unit: mm)

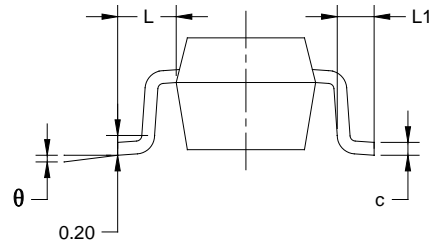
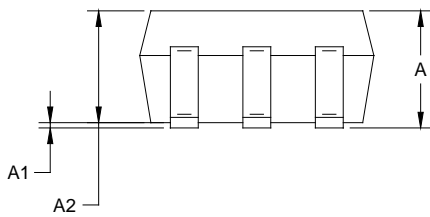

Symbol	Dimensions In Millimeters		Dimensions In Inches	
	MIN	MAX	MIN	MAX
A	0.800	1.100	0.031	0.043
A1	0.000	0.100	0.000	0.004
A2	0.800	1.000	0.031	0.039
b	0.150	0.350	0.006	0.014
c	0.080	0.220	0.003	0.009
D	2.000	2.200	0.079	0.087
E	1.150	1.350	0.045	0.053
E1	2.150	2.450	0.085	0.096
e	0.65 TYP		0.026 TYP	
e1	1.300 BSC		0.051 BSC	
L	0.525 REF		0.021 REF	
L1	0.260	0.460	0.010	0.018
θ	0°	8°	0°	8°

NOTES:

1. Body dimensions do not include mold flash or protrusion.
2. This drawing is subject to change without notice.

PACKAGE OUTLINE DIMENSIONS

SOT-23-5

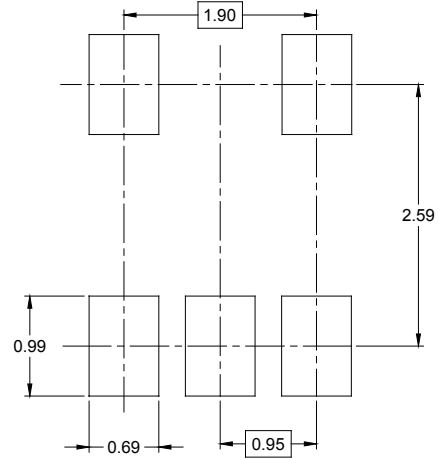
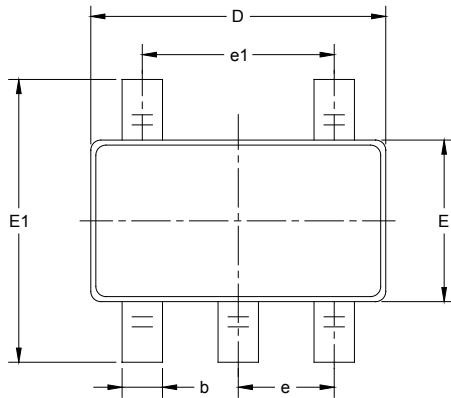

RECOMMENDED LAND PATTERN (Unit: mm)

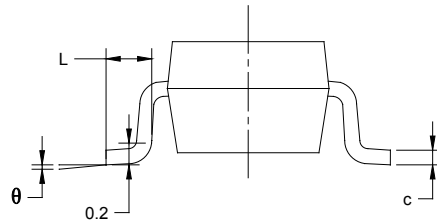
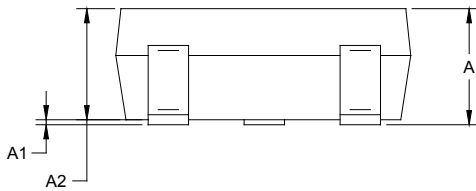

Symbol	Dimensions In Millimeters		Dimensions In Inches	
	MIN	MAX	MIN	MAX
A	1.050	1.250	0.041	0.049
A1	0.000	0.100	0.000	0.004
A2	1.050	1.150	0.041	0.045
b	0.300	0.500	0.012	0.020
c	0.100	0.200	0.004	0.008
D	2.820	3.020	0.111	0.119
E	1.500	1.700	0.059	0.067
E1	2.650	2.950	0.104	0.116
e	0.950 BSC		0.037 BSC	
e1	1.900 BSC		0.075 BSC	
L	0.300	0.600	0.012	0.024
$\theta$	0°	8°	0°	8°



PACKAGE OUTLINE DIMENSIONS

UTDFN-1×1-4L

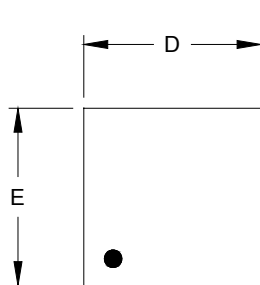

TOP VIEW

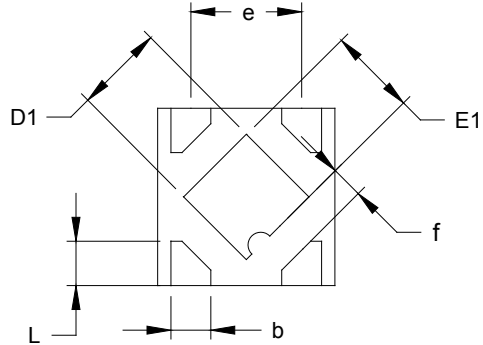

BOTTOM VIEW

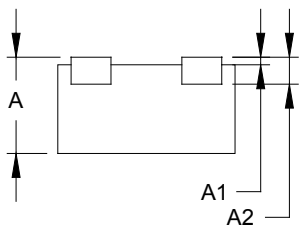

SIDE VIEW

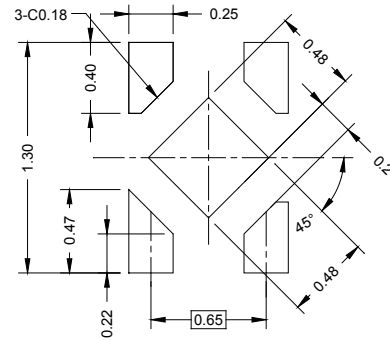

RECOMMENDED LAND PATTERN (Unit: mm)

Symbol	Dimensions In Millimeters		
	MIN	MOD	MAX
A	0.500	0.550	0.600
A1	0.000		0.050
A2	0.152 REF		
D	0.950	1.000	1.050
D1	0.450	0.500	0.550
E	0.950	1.000	1.050
E1	0.450	0.500	0.550
b	0.175	0.225	0.275
e	0.625 BSC		
f	0.195 REF		
L	0.200	0.250	0.300

# PACKAGE INFORMATION

## TAPE AND REEL INFORMATION

### REEL DIMENSIONS



### TAPE DIMENSIONS



NOTE: The picture is only for reference. Please make the object as the standard.

### KEY PARAMETER LIST OF TAPE AND REEL

Package Type	Reel Diameter	Reel Width W1 (mm)	A0 (mm)	B0 (mm)	K0 (mm)	P0 (mm)	P1 (mm)	P2 (mm)	W (mm)	Pin1 Quadrant
SC70-5	7"	9.5	2.25	2.55	1.20	4.0	4.0	2.0	8.0	Q3
SOT-23-5	7"	9.5	3.20	3.20	1.40	4.0	4.0	2.0	8.0	Q3
UTDFN-1×1-4L	7"	9.0	1.20	1.20	0.60	4.0	2.0	2.0	8.0	Q1

DD0001

# PACKAGE INFORMATION

## CARTON BOX DIMENSIONS



NOTE: The picture is only for reference. Please make the object as the standard.

## KEY PARAMETER LIST OF CARTON BOX

Reel Type	Length (mm)	Width (mm)	Height (mm)	Pizza/Carton
7" (Option)	368	227	224	8
7"	442	410	224	18

DD0002

单击下面可查看定价，库存，交付和生命周期等信息

[>>SGMICRO\(圣邦微电子\)](#)