

GENERAL DESCRIPTION

The SGM8552 is a dual rail-to-rail input and output precision operational amplifier which has low input offset voltage and bias current. It is guaranteed to operate from 2.5V to 5.5V single supply.

The rail-to-rail input and output swings provided by the SGM8552 make both high-side and low-side sensing easy. The combination of characteristics makes the SGM8552 a good choice for temperature, position and pressure sensors, medical equipment and strain gauge amplifiers, or any other 2.5V to 5.5V applications requiring precision and long term stability.

The SGM8552 is specified for the extended industrial/automotive (-40°C to +125°C) temperature range. It is available in Green SOIC-8 and MSOP-8 packages and ESD (HBM) reaches 8kV.

APPLICATIONS

- Temperature Measurements
- Pressure Sensors
- Precision Current Sensings
- Electronic Scales
- Strain Gauge Amplifiers
- Medical Instrumentation
- Thermocouple Amplifiers
- Handheld Test Equipment

FEATURES

- **Low Offset Voltage: 20μV (MAX)**
- **Rail-to-Rail Input and Output Swing**
- **2.5V to 5.5V Single-Supply Operation**
- **Voltage Gain: 145dB (TYP) at 5V**
- **PSRR: 110dB (TYP)**
- **CMRR: 105dB (TYP)**
- **Ultra Low Input Bias Current: 10pA**
- **Low Supply Current: 930μA (TYP)**
- **Overload Recovery Time: 60μs (at V_S = 5V)**
- **No External Capacitors Required**
- **-40°C to +125°C Operating Temperature Range**
- **Available in Green SOIC-8 and MSOP-8 Packages**

PIN CONFIGURATION

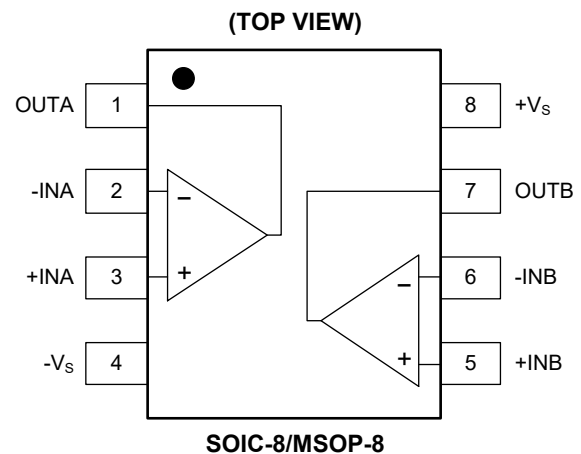

PACKAGE/ORDERING INFORMATION

MODEL	PACKAGE DESCRIPTION	SPECIFIED TEMPERATURE RANGE	ORDERING NUMBER	PACKAGE MARKING	PACKING OPTION
SGM8552	SOIC-8	-40°C to +125°C	SGM8552XS8G/TR	SGM8552XS8 XXXXX	Tape and Reel, 2500
	MSOP-8	-40°C to +125°C	SGM8552XMS8G/TR	SGM8552 XMS8 XXXXX	Tape and Reel, 3000

MARKING INFORMATION

NOTE: XXXXX = Date Code and Vendor Code.

SOIC-8/MSOP-8

XXXXX

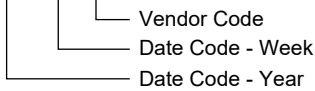

Green (RoHS & HSF): SG Micro Corp defines "Green" to mean Pb-Free (RoHS compatible) and free of halogen substances. If you have additional comments or questions, please contact your SGMICRO representative directly.

ABSOLUTE MAXIMUM RATINGS

- Supply Voltage.....6V
- Input Voltage Range-V_S to (+V_S) + 0.1V
- Differential Input Voltage Range -5V to 5V
- Junction Temperature.....+150°C
- Storage Temperature Range-65°C to +150°C
- Lead Temperature (Soldering, 10s).....+260°C
- ESD Susceptibility
- HBM.....8000V
- MM.....400V

RECOMMENDED OPERATING CONDITIONS

- Operating Temperature Range-40°C to +125°C

OVERSTRESS CAUTION

Stresses beyond those listed in Absolute Maximum Ratings may cause permanent damage to the device. Exposure to absolute maximum rating conditions for extended periods

may affect reliability. Functional operation of the device at any conditions beyond those indicated in the Recommended Operating Conditions section is not implied.

ESD SENSITIVITY CAUTION

This integrated circuit can be damaged by ESD if you don't pay attention to ESD protection. SGMICRO recommends that all integrated circuits be handled with appropriate precautions. Failure to observe proper handling and installation procedures can cause damage. ESD damage can range from subtle performance degradation to complete device failure. Precision integrated circuits may be more susceptible to damage because very small parametric changes could cause the device not to meet its published specifications.

DISCLAIMER

SG Micro Corp reserves the right to make any change in circuit design, or specifications without prior notice.

ELECTRICAL CHARACTERISTICS(At $T_A = +25^\circ\text{C}$, $V_S = 5\text{V}$, $V_{CM} = 2.5\text{V}$, $V_{OUT} = 2.5\text{V}$, Full = -40°C to $+125^\circ\text{C}$, unless otherwise noted.)

PARAMETER	CONDITIONS	TEMP	MIN	TYP	MAX	UNITS
Input Characteristics						
Input Offset Voltage (V_{OS})		+25°C		4	20	μV
		Full			24	
Input Bias Current (I_b)		+25°C		10		pA
Input Offset Current (I_{OS})		+25°C		5		pA
Input Voltage Range		Full	0		5	V
Common Mode Rejection Ratio ⁽¹⁾ (CMRR)	$V_{CM} = 0\text{V}$ to 5V	+25°C	90	105		dB
		Full	83			
Large-Signal Voltage Gain (A_{VO})	$R_L = 10\text{k}\Omega$, $V_{OUT} = 0.3\text{V}$ to 4.7V	+25°C	100	145		dB
		Full	97			
Input Offset Voltage Drift ($\Delta V_{OS}/\Delta T$)		Full		20		$\text{nV}/^\circ\text{C}$
Output Characteristics						
Output Voltage High (V_{OH})	$R_L = 100\text{k}\Omega$ to $-V_S$	+25°C	4.99	4.998		V
		Full	4.987			
	$R_L = 10\text{k}\Omega$ to $-V_S$	+25°C	4.985	4.996		
		Full	4.98			
Output Voltage Low (V_{OL})	$R_L = 100\text{k}\Omega$ to $+V_S$	+25°C		2	10	mV
		Full			13	
	$R_L = 10\text{k}\Omega$ to $+V_S$	+25°C		6	15	
		Full			20	
Short-Circuit Limit (I_{SC})	$V_{OUT} = 2.5\text{V}$, $R_L = 10\Omega$ to GND	+25°C	40	48		mA
		Full	23			
Power Supply						
Power Supply Rejection Ratio ⁽¹⁾ (PSRR)	$V_S = 2.5\text{V}$ to 5.5V	+25°C	90	110		dB
		Full	80			
Quiescent Current (I_Q)	$V_{OUT} = V_S/2$	+25°C		930	1110	μA
		Full			1760	
Dynamic Performance						
Gain-Bandwidth Product (GBP)	$A_V = +100$	+25°C		1.53		MHz
Slew Rate (SR)	$A_V = +1$, $R_L = 10\text{k}\Omega$, 2V output step	+25°C		0.90		$\text{V}/\mu\text{s}$
Overload Recovery Time	$A_V = -100$, $R_L = 10\text{k}\Omega$, $V_{IN} = 200\text{mV}$ (RET to GND)	+25°C		0.06		ms
Noise Performance						
Input Voltage Noise ($e_{n,P-P}$)	0.1Hz to 10Hz	+25°C		0.80		μV_{P-P}
Input Voltage Noise Density (e_n)	$f = 1\text{kHz}$	+25°C		47.5		$\text{nV}/\sqrt{\text{Hz}}$

NOTE: 1. PSRR and CMRR are affected by the matching between external gain-setting resistor ratios.

ELECTRICAL CHARACTERISTICS (continued)(At $T_A = +25^\circ\text{C}$, $V_S = 2.5\text{V}$, $V_{CM} = 1.25\text{V}$, $V_{OUT} = 1.25\text{V}$, Full = -40°C to $+125^\circ\text{C}$, unless otherwise noted.)

PARAMETER	CONDITIONS	TEMP	MIN	TYP	MAX	UNITS
Input Characteristics						
Input Offset Voltage (V_{OS})		+25°C		3	20	μV
		Full			24	
Input Bias Current (I_b)		+25°C		10		pA
Input Offset Current (I_{OS})		+25°C		10		pA
Input Voltage Range		Full	0		2.5	V
Common Mode Rejection Ratio ⁽¹⁾ (CMRR)	$V_{CM} = 0\text{V}$ to 2.5V	+25°C	90	105		dB
		Full	81			
Large-Signal Voltage Gain (A_{VO})	$R_L = 10\text{k}\Omega$, $V_{OUT} = 0.3\text{V}$ to 2.4V	+25°C	100	135		dB
		Full	94			
Input Offset Voltage Drift ($\Delta V_{OS}/\Delta T$)		Full		20		$\text{nV}/^\circ\text{C}$
Output Characteristics						
Output Voltage High (V_{OH})	$R_L = 100\text{k}\Omega$ to $-V_S$	+25°C	2.49	2.499		V
		Full	2.488			
	$R_L = 10\text{k}\Omega$ to $-V_S$	+25°C	2.485	2.498		
		Full	2.482			
Output Voltage Low (V_{OL})	$R_L = 100\text{k}\Omega$ to $+V_S$	+25°C		1	10	mV
		Full			12	
	$R_L = 10\text{k}\Omega$ to $+V_S$	+25°C		3	15	
		Full			18	
Short-Circuit Limit (I_{SC})	$V_{OUT} = 1.25\text{V}$, $R_L = 10\Omega$ to GND	+25°C	20	28		mA
		Full	15			
Power Supply						
Power Supply Rejection Ratio ⁽¹⁾ (PSRR)	$V_S = 2.5\text{V}$ to 5.5V	+25°C	90	110		dB
		Full	80			
Quiescent Current (I_Q)	$V_{OUT} = V_S/2$	+25°C		1000	1110	μA
		Full			2090	
Dynamic Performance						
Gain-Bandwidth Product (GBP)	$A_V = +100$	+25°C		1.51		MHz
Slew Rate (SR)	$A_V = +1$, $R_L = 10\text{k}\Omega$, 2V output step	+25°C		0.90		$\text{V}/\mu\text{s}$
Overload Recovery Time	$A_V = -100$, $R_L = 10\text{k}\Omega$, $V_{IN} = 200\text{mV}$ (RET to GND)	+25°C		0.03		ms
Noise Performance						
Input Voltage Noise ($e_{n,P-P}$)	0.1Hz to 10Hz	+25°C		0.95		μV_{P-P}
Input Voltage Noise Density (e_n)	$f = 1\text{kHz}$	+25°C		53		$\text{nV}/\sqrt{\text{Hz}}$

NOTE: 1. PSRR and CMRR are affected by the matching between external gain-setting resistor ratios.

TYPICAL PERFORMANCE CHARACTERISTICS

Large Signal Transient Response at +5V

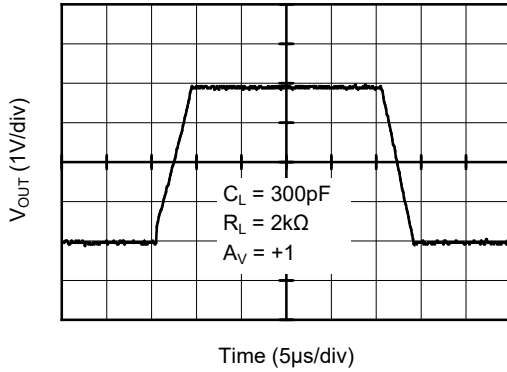

Large Signal Transient Response at +2.5V

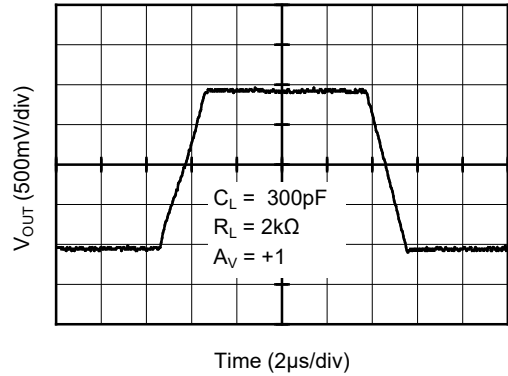

Small Signal Transient Response at +5V

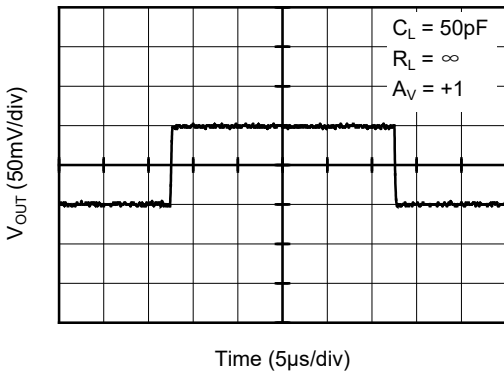

Small Signal Transient Response at +2.5V

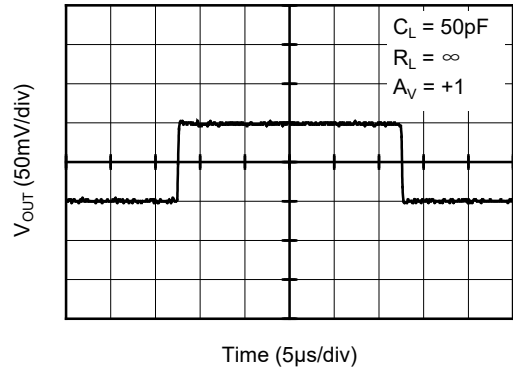

Closed Loop Gain vs. Frequency at +5V

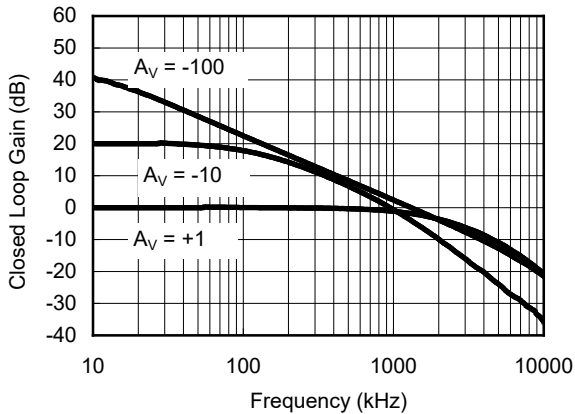

Closed Loop Gain vs. Frequency at +2.5V

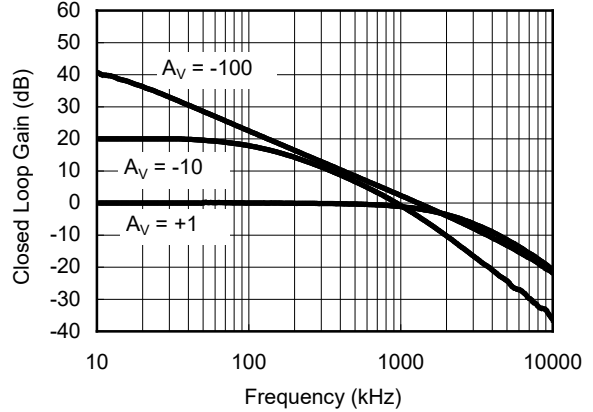

TYPICAL PERFORMANCE CHARACTERISTICS (continued)

Positive Overvoltage Recovery

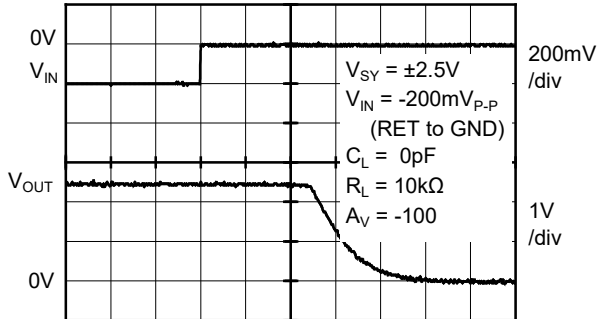

Time (20µs/div)

Negative Overvoltage Recovery

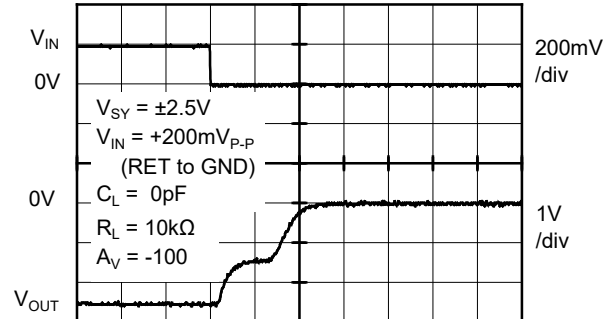

Time (50µs/div)

Open Loop Gain, Phase Shift vs. Frequency at +5V

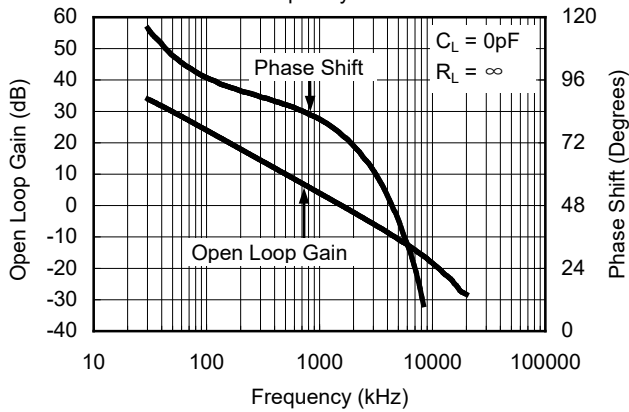

Open Loop Gain, Phase Shift vs. Frequency at +2.5V

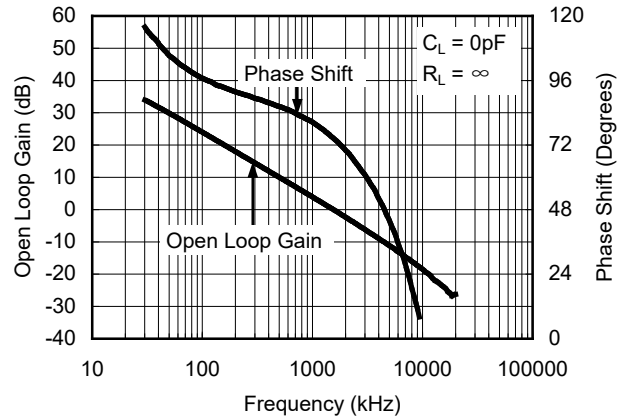

0.1Hz to 10Hz Noise at +5V

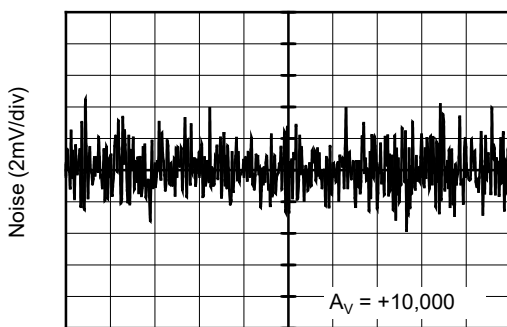

Time (10s/div)

0.1Hz to 10Hz Noise at +2.5V

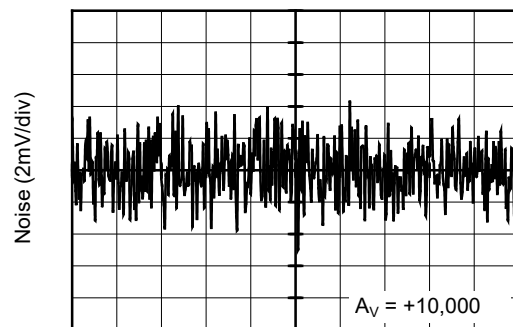

Time (10s/div)

TYPICAL PERFORMANCE CHARACTERISTICS (continued)

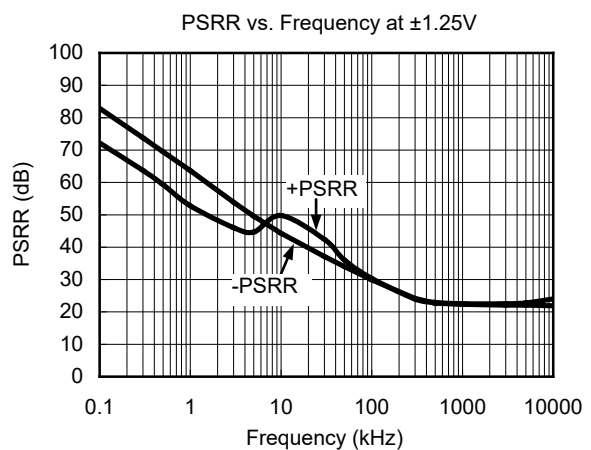
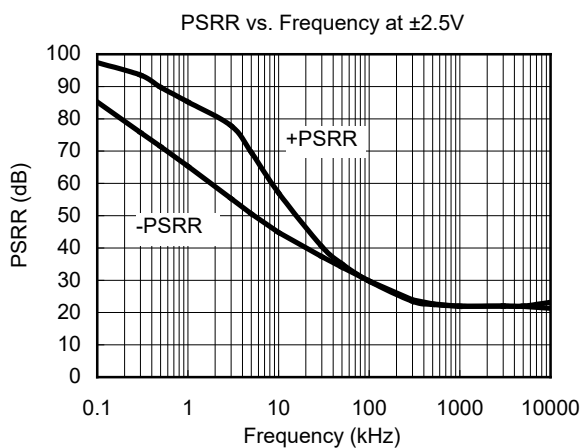
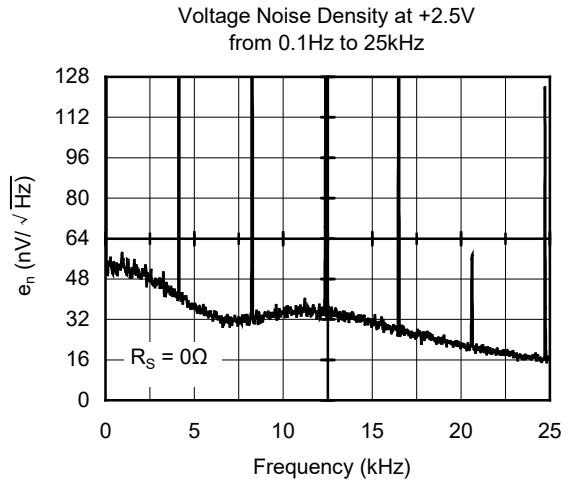
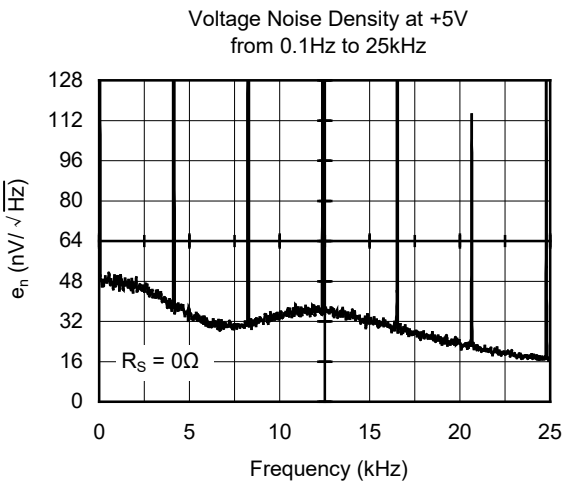
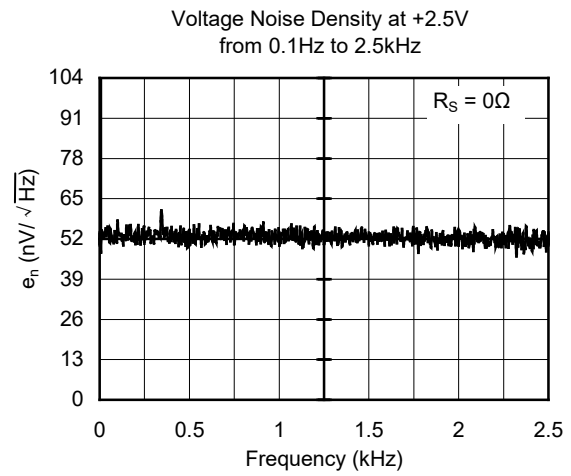
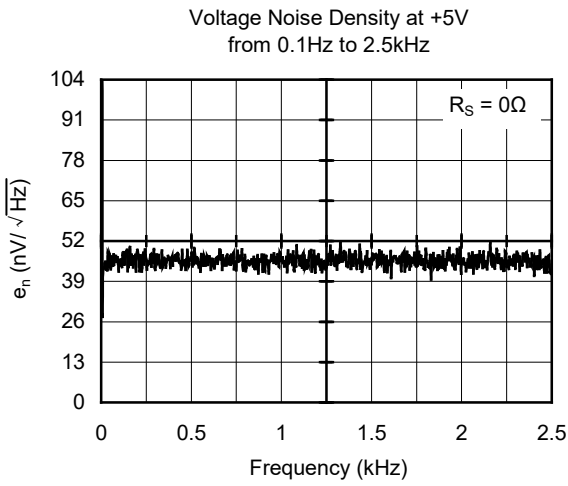

TYPICAL PERFORMANCE CHARACTERISTICS (continued)

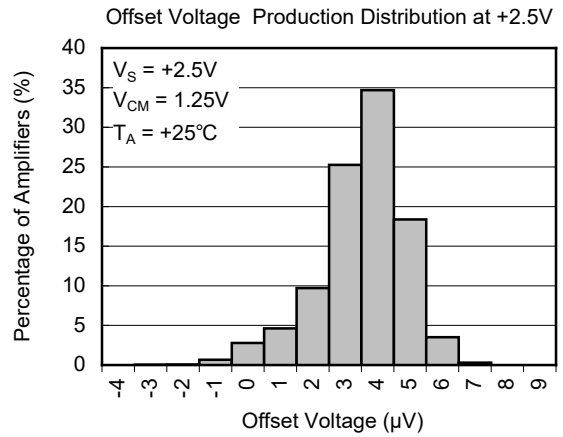
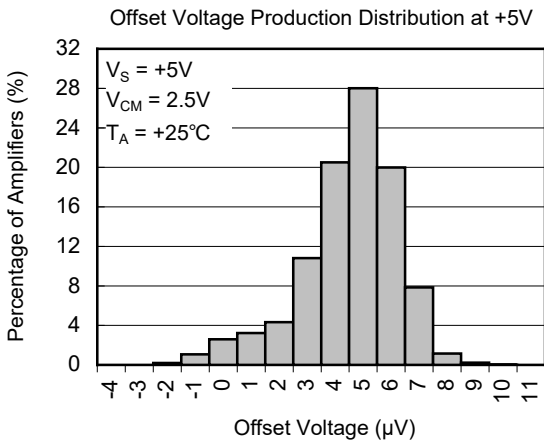
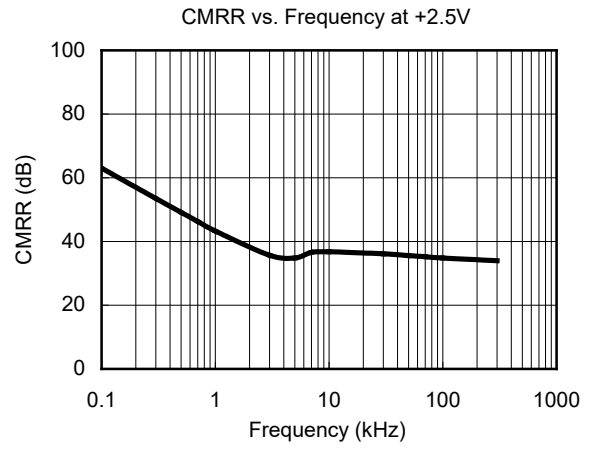
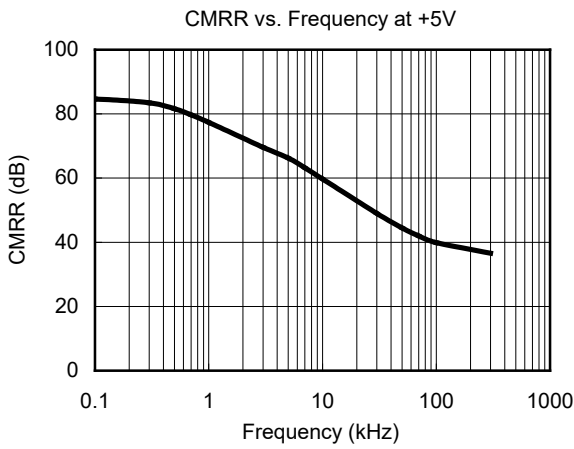

REVISION HISTORY

NOTE: Page numbers for previous revisions may differ from page numbers in the current version.

JANUARY 2013 – REV.A.3 to REV.A.4	Page
Added Tape and Reel Information section	12, 13
<hr/>	
DECEMBER 2011 – REV.A.2 to REV.A.3	Page
Changed Electrical Characteristics section	3, 4
Changed Typical Performance Characteristics section	7
Changed Package Outline Dimensions section	9, 10
<hr/>	
MAY 2011 – REV.A.1 to REV.A.2	Page
Changed packages' name	All
<hr/>	
APRIL 2010 – REV.A to REV.A.1	Page
Changed Typical Performance Characteristics section	8
<hr/>	
Changes from Original (MARCH 2010) to REV.A	Page
Changed from product preview to production data	All

PACKAGE OUTLINE DIMENSIONS

SOIC-8

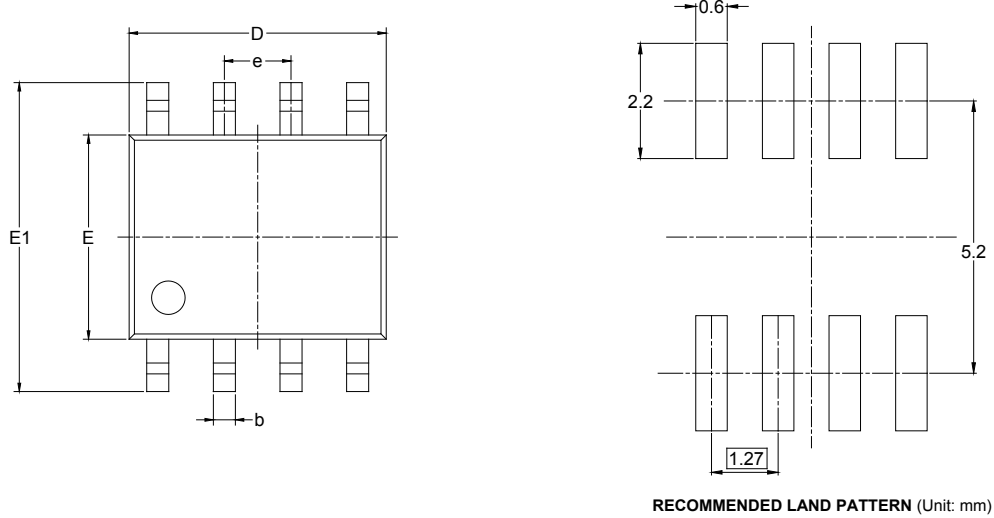

Symbol	Dimensions In Millimeters		Dimensions In Inches	
	MIN	MAX	MIN	MAX
A	1.350	1.750	0.053	0.069
A1	0.100	0.250	0.004	0.010
A2	1.350	1.550	0.053	0.061
b	0.330	0.510	0.013	0.020
c	0.170	0.250	0.006	0.010
D	4.700	5.100	0.185	0.200
E	3.800	4.000	0.150	0.157
E1	5.800	6.200	0.228	0.244
e	1.27 BSC		0.050 BSC	
L	0.400	1.270	0.016	0.050
θ	0°	8°	0°	8°

PACKAGE OUTLINE DIMENSIONS

MSOP-8

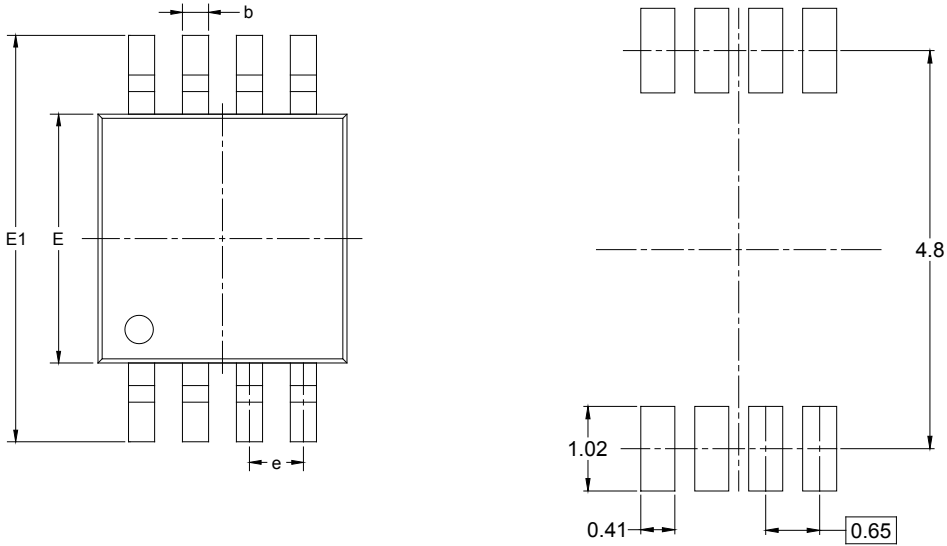

RECOMMENDED LAND PATTERN (Unit: mm)

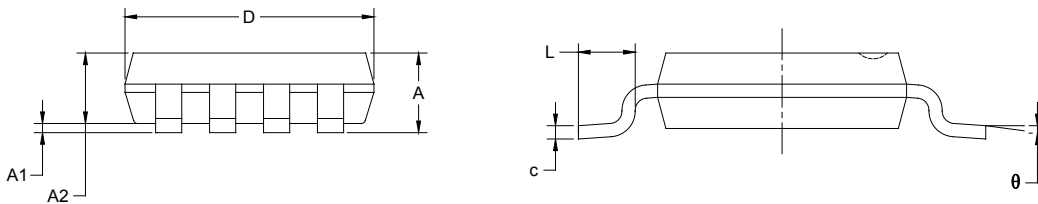

Symbol	Dimensions In Millimeters		Dimensions In Inches	
	MIN	MAX	MIN	MAX
A	0.820	1.100	0.032	0.043
A1	0.020	0.150	0.001	0.006
A2	0.750	0.950	0.030	0.037
b	0.250	0.380	0.010	0.015
c	0.090	0.230	0.004	0.009
D	2.900	3.100	0.114	0.122
E	2.900	3.100	0.114	0.122
E1	4.750	5.050	0.187	0.199
e	0.650 BSC		0.026 BSC	
L	0.400	0.800	0.016	0.031
θ	0°	6°	0°	6°

TAPE AND REEL INFORMATION

REEL DIMENSIONS



TAPE DIMENSIONS



NOTE: The picture is only for reference. Please make the object as the standard.

KEY PARAMETER LIST OF TAPE AND REEL

Package Type	Reel Diameter	Reel Width W1 (mm)	A0 (mm)	B0 (mm)	K0 (mm)	P0 (mm)	P1 (mm)	P2 (mm)	W (mm)	Pin1 Quadrant
SOIC-8	13"	12.4	6.40	5.40	2.10	4.0	8.0	2.0	12.0	Q1
MSOP-8	13"	12.4	5.20	3.30	1.50	4.0	8.0	2.0	12.0	Q1

DD0001

PACKAGE INFORMATION

CARTON BOX DIMENSIONS



NOTE: The picture is only for reference. Please make the object as the standard.

KEY PARAMETER LIST OF CARTON BOX

Reel Type	Length (mm)	Width (mm)	Height (mm)	Pizza/Carton
13"	386	280	370	5

DD0002

单击下面可查看定价，库存，交付和生命周期等信息

[>>SGMICRO\(圣邦微电子\)](#)