

**FEATURES and FUNCTIONAL DIAGRAM**

- 1 mΩ primary conductor resistance for low power loss and high inrush current withstand capability
- High-bandwidth 120 kHz analog output for faster response times in control applications
- Filter pin allows user to filter the output for improved resolution at lower bandwidth
- +/-2.5% output error for full temperature range(-40°C~150°C)
- Small-footprint, low-profile SOIC8 package suitable for space-constrained applications
- Selected single supply operation: 5V/3.3V
- Output voltage proportional to AC or DC current
- Factory-trimmed sensitivity and quiescent output voltage for improved accuracy
- Chopper stabilization results in extremely stable quiescent output voltage

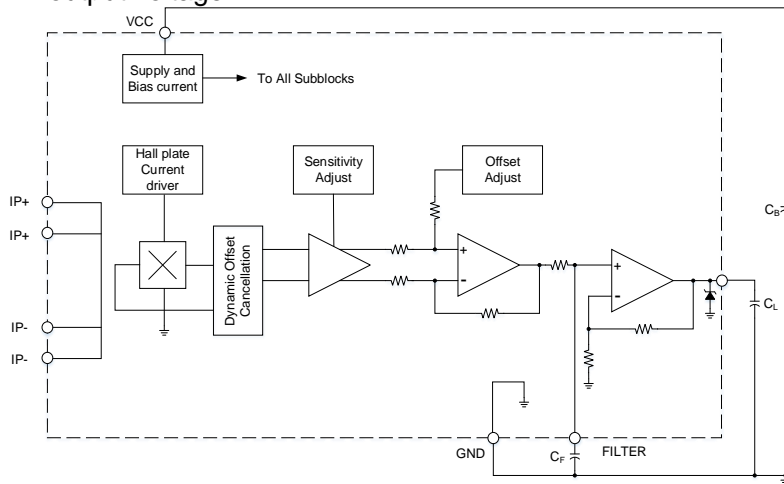

**PACKAGE**

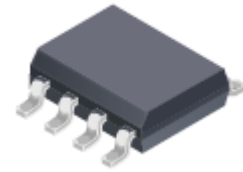

SOP8(LC)



Approximate Scale 1:1

**APPLICATIONS**

motor control;  
load detection and management;  
switch-mode power supplies;  
over current fault protection;

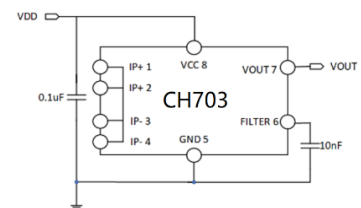

**DESCRIPTION**

The CH703 current sensor IC is an economical and precise solution for AC or DC current sensing in industrial, commercial, and communications systems. The small package is ideal for space-constrained applications while also saving costs due to reduced board area. Typical applications include motor control, load detection and management, switched-mode power supplies, and overcurrent fault protection.

The device consists of a precise, low-offset, linear Hall sensor circuit with a copper conduction path located near the surface of the die. Applied current flowing through this copper conduction path generates a magnetic field which is sensed by the integrated Hall IC and converted into a proportional voltage. A precise, proportional voltage is provided by the low-offset, chopper-stabilized BCD Hall IC, which is programmed for accuracy after packaging. The output of the device has a positive slope when an increasing current flows through the primary copper conduction path (from pins 1 and 2, to pins 3 and 4), which is the path used for current sensing. The internal resistance of this conductive path is 1 mΩ typical, providing low power loss.

The terminals of the conductive path are electrically isolated from the sensor leads (pins 5 through 8). This allows the CH703 current sensor IC to be used in high-side current sense applications without the use of high-side differential amplifiers or other costly isolation techniques.

The CH703 is provided in a small, low-profile surface-mount SOIC8 package. The leadframe is plated with 100% matte tin, which is compatible with standard lead (Pb) free printed circuit board assembly processes. Internally, the device is Pb-free, except for flip-chip high-temperature Pb-based solder balls, currently exempt from RoHS. The device is fully calibrated prior to shipment from the factory.

	<b>Cosemitech</b>	<b>CH703</b>
	<b>Automotive Product Group</b>	<small>This is advanced information on a new product now in development or undergoing evaluation. Details are subject to change without notice and Cosemitech assumes no obligation for future manufacture of this product. Contact Cosemitech for the latest status.</small>

**Preliminary datasheet REV 0.6**

## Table of Contents

<b>1</b>	<b>PRODUCT FAMILY MEMBERS .....</b>	<b>3</b>
<b>2</b>	<b>PIN DEFINITIONS AND DESCRIPTIONS .....</b>	<b>4</b>
<b>3</b>	<b>ABSOLUTE MAXIMUM RATINGS .....</b>	<b>5</b>
<b>4</b>	<b>ESD PROTECTIONS .....</b>	<b>5</b>
<b>5</b>	<b>ELECTRICAL CHARACTERISTICS<sup>1</sup>: .....</b>	<b>6</b>
<b>6</b>	<b>FUNCTION DESCRIPTION.....</b>	<b>66</b>
<b>7</b>	<b>APPLICATION INFORMATION .....</b>	<b>66</b>
<b>8</b>	<b>PACKAGE INFORMATION: .....</b>	<b>81</b>



**Cosemitech**

**CH703**

**Automotive Product Group**

This is advanced information on a new product now in development or undergoing evaluation. Details are subject to change without notice and Cosemitech assumes no obligation for future manufacture of this product. Contact Cosemitech for the latest status.

**Preliminary datasheet REV 0.6**

# 1 Product Family Members

Part Number	VCC (V)	I <sub>PR</sub> (A)	Sens (mV/A)	T <sub>J</sub> (°C)	Packing
CH70305AU5*	5±0.5	5	800	-40 to 150	Tape and Reel, 3000 pieces per reel
CH70305AU3*	3.3±0.3	5	528		
CH70305AB5*	5±0.5	±5	400		
CH70305AB3*	3.3±0.3	±5	264		
CH70305BU5*	5±0.5	5	800		
CH70305BB5*	5±0.5	±5	400		
CH70305CU5*	5±0.5	5	528		
CH70305CU3*	3.3±0.3	5	528		
CH70305CB5*	5±0.5	±5	264		
CH70305CB3*	3.3±0.3	±5	264		
CH70310AU5*	5±0.5	10	400		
CH70310AU3*	3.3±0.3	10	264		
CH70310AB5*	5±0.5	±10	200		
CH70310AB3*	3.3±0.3	±10	132		
CH70310BU5*	5±0.5	10	400		
CH70310BB5*	5±0.5	±10	200		
CH70310CU5*	5±0.5	10	264		
CH70310CU3*	3.3±0.3	10	264		
CH70310CB5*	5±0.5	±10	132		
CH70310CB3*	3.3±0.3	±10	132		
CH70320AU5*	5±0.5	20	200		
CH70320AU3*	3.3±0.3	20	132		
CH70320AB5*	5±0.5	±20	100		
CH70320AB3*	3.3±0.3	±20	66		
CH70320BU5*	5±0.5	20	200		
CH70320BB5*	5±0.5	±20	100		
CH70320CU5*	5±0.5	20	132		
CH70320CU3*	3.3±0.3	20	132		
CH70320CB5*	5±0.5	±20	66		
CH70320CB3*	3.3±0.3	±20	66		
CH70330AU5*	5±0.5	30	133		
CH70330AU3*	3.3±0.3	30	88		
CH70330AB5*	5±0.5	±30	66		
CH70330AB3*	3.3±0.3	±30	44		
CH70330BU5*	5±0.5	30	133		
CH70330BB5*	5±0.5	±30	66		
CH70330CU5*	5±0.5	30	88		
CH70330CU3*	3.3±0.3	30	88		
CH70330CB5*	5±0.5	±30	44		
CH70330CB3*	3.3±0.3	±30	44		
CH70340AU5*	5±0.5	40	100		
CH70340AU3*	3.3±0.3	40	66		
CH70340AB5*	5±0.5	±40	50		
CH70340AB3*	3.3±0.3	±40	33		
CH70340BU5*	5±0.5	40	100		
CH70340BB5*	5±0.5	±40	50		
CH70340CU5*	5±0.5	40	66		
CH70340CU3*	3.3±0.3	40	66		
CH70340CB5*	5±0.5	±40	33		
CH70340CB3*	3.3±0.3	±40	33		
CH70350AU5*	5±0.5	50	80		
CH70350AU3*	3.3±0.3	50	52		
CH70350AB5*	5±0.5	±50	40		
CH70350AB3*	3.3±0.3	±50	26		
CH70350BU5*	5±0.5	50	80		
CH70350BB5*	5±0.5	±50	40		
CH70350CU5*	5±0.5	50	52		
CH70350CU3*	3.3±0.3	50	52		
CH70350CB5*	5±0.5	±50	26		
CH70350CB3*	3.3±0.3	±50	26		
CH70360AU5*	5±0.5	60	66		
CH70360AU3*	3.3±0.3	60	44		
CH70360AB5*	5±0.5	±60	33		
CH70360AB3*	3.3±0.3	±60	22		

	<b>Cosemitech</b>	<b>CH703</b>
	<b>Automotive Product Group</b>	This is advanced information on a new product now in development or undergoing evaluation. Details are subject to change without notice and Cosemitech assumes no obligation for future manufacture of this product. Contact Cosemitech for the latest status.

**Preliminary datasheet REV 0.6**

<b>CH70360BU5*</b>	5±0.5	60	66		
<b>CH70360BB5*</b>	5±0.5	±60	33		
<b>CH70360CU5*</b>	5±0.5	60	44		
<b>CH70360CU3*</b>	3.3±0.3	60	44		
<b>CH70360CB5*</b>	5±0.5	±60	22		
<b>CH70360CB3*</b>	3.3±0.3	±60	22		

CH703x is available in a variety of delivery forms. They are distinguished by a specific nomenclature code:

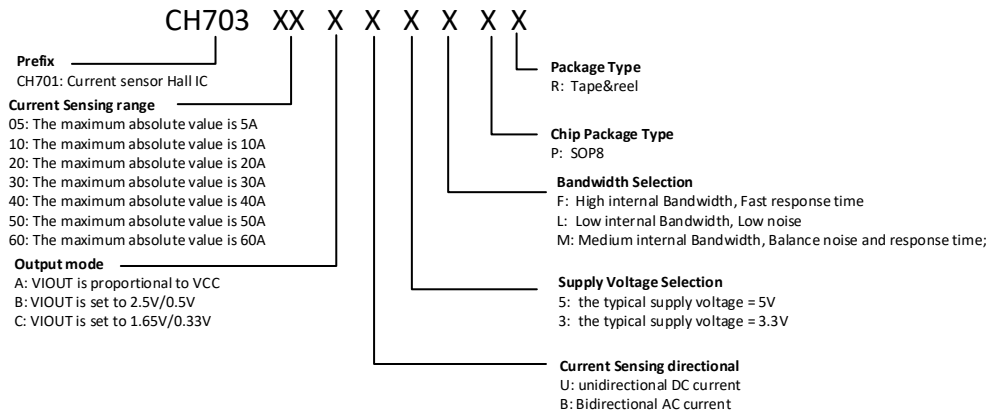

## 2 Pin Definitions and Descriptions

Number	Name	Function
<b>1,2</b>	IP+	Terminals for current being sensed; fused internally
<b>3,4</b>	IP-	Terminals for current being sensed; fused internally
<b>5</b>	GND	Signal ground terminal
<b>6</b>	FILTER	Terminal for external capacitor that sets bandwidth
<b>7</b>	VIOUT	Analog output signal
<b>8</b>	VCC	Device power supply terminal

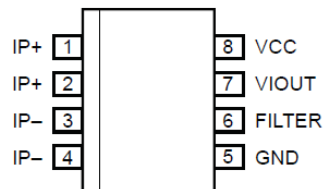

**Package LC, 8-Pin SOICN  
Pin-Out Diagram**

	<b>Cosemitech</b>	<b>CH703</b>
	<b>Automotive Product Group</b>	This is advanced information on a new product now in development or undergoing evaluation. Details are subject to change without notice and Cosemitech assumes no obligation for future manufacture of this product. Contact Cosemitech for the latest status.

Preliminary datasheet REV 0.6

### 3 Absolute Maximum Ratings

Parameter	Symbol	Min	Max	Units
Supply Voltage	$V_{CC}$	-	6	V
Reverse Supply Voltage	$V_{RCC}$	-0.1	-	V
Output Voltage	$V_{IOUT}$	-	$V_{CC} + 0.5$	V
Reverse Output Voltage	$V_{RIOUT}$	-0.1	-	V
Operating Ambient Temperature	$T_A$	-40	150	°C
Storage Temperature	$T_S$	-65	165	°C
Junction temperature	$T_{J(max)}$		165	°C

Note 1: Exceeding the absolute maximum ratings may cause permanent damage. Exposure to absolute-maximum- rated conditions for extended periods may affect device reliability.

### Isolation Characteristics

Characteristic	Symbol	Notes	Rating	Unit
Dielectric Strength Test Voltage	$V_{ISO}$	Agency type-tested for 60 seconds per UL 62368-1 (edition 3); production-tested at $V_{ISO}$ for 1 second, in accordance with UL 62368-1 (edition 3). UL62368-1 (edition 3) replaces UL60950-1.	2100	$V_{RMS}$
Working Voltage for Basic Isolation	$V_{WVBI}$	Maximum approved working voltage for basic (single) isolation according to UL 62368-1 (edition 3). UL62368-1 (edition 3) replaces UL60950-1.	420	$V_{pk}$ or VDC
			297	$V_{rms}$

### Thermal Characteristics

Characteristic	Symbol	Test Conditions*	Value	Units
Package Thermal Resistance (Junction to Ambient)	$R_{\theta JA}$		23	°C/W
Package Thermal Resistance (Junction to Lead)	$R_{\theta JL}$		5	°C/W

### 4 ESD Protections

Parameter	Value	Unit
All pins <sup>1)</sup>	±8000	V
All pins <sup>2)</sup>	±400	V
All pins <sup>3)</sup>	±1500	V

1) HBM (human body mode, 100pF, 1.5 kΩ ) according to MIL-STD-883H Method 3015.8

2) MM (Machine Mode C=200pF, R=0Ω) according to JEDEC EIA/JESD22-A115

3) CDM (charged device mode) according to JEDEC EIA/JESD22-C101F

	<b>Cosemitech</b>	<b>CH703</b>
	<b>Automotive Product Group</b>	This is advanced information on a new product now in development or undergoing evaluation. Details are subject to change without notice and Cosemitech assumes no obligation for future manufacture of this product. Contact Cosemitech for the latest status.

Preliminary datasheet REV 0.6

## 5 Electrical Characteristics<sup>1</sup>:

Valid through the full range of  $T_A$ ,  $V_{CC} = 5\text{ V}$ ,  $C_F = 0$ , unless otherwise specified

Characteristic	Symbol	Test Conditions	Min.	Typ.	Max.	Unit
Supply Current	$I_{CC}$	$V_{CC} = 5\text{ V}$ , output open	–	10	14	mA
Output Capacitance Load	$C_L$	VIOOUT to GND	–	–	10	nF
Output Resistive Load	$R_L$	VIOOUT to GND	4.7	–	–	k $\Omega$
Primary Conductor Resistance	$R_{IP}$	$T_A = 25^\circ\text{C}$	–	1	–	m $\Omega$
Internal Filter Resistance <sup>2</sup>	$R_{F(int)}$		–	1.7	–	k $\Omega$
Rise Time	$t_r$	$I_P = I_P(max)$ , $T_A = 25^\circ\text{C}$ , $C_L = 1\text{ nF}$	–	3	–	$\mu\text{s}$
Propagation Delay	$t_{pd}$	$I_P = I_P(max)$ , $T_A = 25^\circ\text{C}$ , $C_L = 1\text{ nF}$	–	2	–	$\mu\text{s}$
Response Time	$t_{RESPONSE}$	$I_P = I_P(max)$ , $T_A = 25^\circ\text{C}$ , $C_L = 1\text{ nF}$	–	4	–	$\mu\text{s}$
Bandwidth	BW	Small signal –3 dB; $C_L = 1\text{ nF}$	–	120	–	kHz
Noise Density	IND	Input-referenced noise density; $T_A = 25^\circ\text{C}$ , $C_L = 1\text{ nF}$	–	150	–	$\mu\text{A}_{(rms)}/\sqrt{\text{Hz}}$
Noise	IN	Input-referenced noise: $C_F = 4.7\text{ nF}$ , $C_L = 1\text{ nF}$ , BW = 18 kHz, $T_A = 25^\circ\text{C}$	–	20	–	$\text{mA}_{(rms)}$
Nonlinearity	ELIN	Through full range of $I_P$		$\pm 1$		%
Sensitivity Ratiometry Coefficient	SENS_RAT_COEF	$V_{CC} = 4.5\text{ to }5.5\text{ V}$ , $T_A = 25^\circ\text{C}$	–	1.3	–	–
Zero-Current Output Ratiometry Coefficient	QVO_RAT_COEF	$V_{CC} = 4.5\text{ to }5.5\text{ V}$ , $T_A = 25^\circ\text{C}$	–	1	–	–
Saturation Voltage <sup>3</sup>	$V_{OH}$	$R_L = 4.7\text{ k}\Omega$	$V_{CC} - 0.2$	–	–	V
	$V_{OL}$	$R_L = 4.7\text{ k}\Omega$	–	–	0.2	V
Power-On Time	$t_{PO}$	Output reaches 90% of steady-state level, $T_A = 25^\circ\text{C}$ , $I_P = I_{PR(max)}$ applied	–	80	–	$\mu\text{s}$
Shorted Output-to-Ground Current	$I_{SC(GND)}$	$T_A = 25^\circ\text{C}$	–	3.3	–	mA
Shorted Output-to- $V_{CC}$ Current	$I_{SC(VCC)}$	$T_A = 25^\circ\text{C}$	–	45	–	mA

<sup>1</sup>Device may be operated at higher primary current levels,  $I_P$ , ambient temperatures,  $T_A$ , and internal leadframe temperatures, provided the Maximum Junction Temperature,  $T_J(max)$ , is not exceeded.

<sup>2</sup> $R_{F(int)}$  forms an RC circuit via the FILTER pin.

<sup>3</sup>The sensor IC will continue to respond to current beyond the range of  $I_P$  until the high or low saturation voltage; however, the nonlinearity in this region will be worse than through the rest of the measurement range.

	<b>Cosemitech</b>	<b>CH703</b>
	<b>Automotive Product Group</b>	This is advanced information on a new product now in development or undergoing evaluation. Details are subject to change without notice and Cosemitech assumes no obligation for future manufacture of this product. Contact Cosemitech for the latest status.

**Preliminary datasheet REV 0.6**

**CH70305AU5\* Performance Characteristics: T<sub>A</sub> Range L, valid at T<sub>A</sub> = -40°C to 150°C, unless otherwise specified**

Characteristic	Symbol	Test Conditions	Min.	Typ. <sup>1</sup>	Max.	Unit
<b>Nominal Performance</b>						
Supply Voltage	V <sub>CC</sub>		4.5	–	5.5	V
Current-Sensing Range	I <sub>PR</sub>		0	–	5	A
Sensitivity	Sens	I <sub>PR(min)</sub> < I <sub>P</sub> < I <sub>PR(max)</sub> , VCC = 5V	–	740	–	mV/A
Zero-Current Output Voltage	V <sub>IOUT(Q)</sub>	Unidirectional, I <sub>P</sub> = 0 A, VCC = 5V	–	0.65	–	V
<b>Accuracy Performance</b>						
Total Output Error <sup>2</sup>	E <sub>TOT</sub>	I <sub>P</sub> = I <sub>PR(max)</sub> , T <sub>A</sub> = -40°C to 150°C	–3		3	%
<b>Total Output Error Components<sup>3</sup> E<sub>TOT</sub> = E<sub>SENS</sub> + 100 × V<sub>OE</sub>/(Sens × I<sub>P</sub>)</b>						
Sensitivity Error	E <sub>sens</sub>	I <sub>P</sub> = I <sub>PR(max)</sub> , T <sub>A</sub> = -40°C to 150°C	–2.5		2.5	%
Offset Voltage	V <sub>OE</sub>	I <sub>P</sub> = 0 A, T <sub>A</sub> = -40°C to 150°C	–15	±7	15	mV
<b>Lifetime Drift Characteristics</b>						
Sensitivity Error Lifetime Drift	E <sub>sens_drift</sub>			±1		%
Total Output Error Lifetime Drift	E <sub>tot_drift</sub>			±1		%

<sup>1</sup> Typical values with +/- are 3 sigma values

<sup>2</sup> Percentage of I<sub>P</sub>, with I<sub>P</sub> = I<sub>PR(max)</sub>.

<sup>3</sup> A single part will not have both the maximum/minimum sensitivity error and maximum/minimum offset voltage, as that would violate the maximum/minimum total output error specification. Also, 3 sigma distribution values are combined by taking the square root of the sum of the squares. See Application Information section.

	<b>Cosemitech</b>	<b>CH703</b>
	<b>Automotive Product Group</b>	This is advanced information on a new product now in development or undergoing evaluation. Details are subject to change without notice and Cosemitech assumes no obligation for future manufacture of this product. Contact Cosemitech for the latest status.

**Preliminary datasheet REV 0.6**

**CH70305AU3\* Performance Characteristics: T<sub>A</sub> Range L, valid at T<sub>A</sub> = -40°C to 150°C, unless otherwise specified**

Characteristic	Symbol	Test Conditions	Min.	Typ. <sup>1</sup>	Max.	Unit
<b>Nominal Performance</b>						
Supply Voltage	V <sub>CC</sub>		3	–	3.6	V
Current-Sensing Range	I <sub>PR</sub>		0	–	5	A
Sensitivity	Sens	I <sub>PR(min)</sub> < I <sub>P</sub> < I <sub>PR(max)</sub> , VCC = 3.3V	–	480	–	mV/A
Zero-Current Output Voltage	V <sub>IOUT(Q)</sub>	Unidirectional, I <sub>P</sub> = 0 A, VCC = 3.3V	–	0.45	–	V
<b>Accuracy Performance</b>						
Total Output Error <sup>2</sup>	E <sub>TOT</sub>	I <sub>P</sub> = I <sub>PR(max)</sub> , T <sub>A</sub> = -40°C to 150°C	-3		3	%
<b>Total Output Error Components<sup>3</sup> E<sub>TOT</sub> = E<sub>SENS</sub> + 100 × V<sub>OE</sub>/(Sens × I<sub>P</sub>)</b>						
Sensitivity Error	E <sub>sens</sub>	I <sub>P</sub> = I <sub>PR(max)</sub> , T <sub>A</sub> = -40°C to 150°C	-2.5		2.5	%
Offset Voltage	V <sub>OE</sub>	I <sub>P</sub> = 0 A, T <sub>A</sub> = -40°C to 150°C	-15	±7	15	mV
<b>Lifetime Drift Characteristics</b>						
Sensitivity Error Lifetime Drift	E <sub>sens_drift</sub>			±1		%
Total Output Error Lifetime Drift	E <sub>tot_drift</sub>			±1		%

<sup>1</sup> Typical values with +/- are 3 sigma values

<sup>2</sup> Percentage of I<sub>P</sub>, with I<sub>P</sub> = I<sub>PR(max)</sub>.

<sup>3</sup> A single part will not have both the maximum/minimum sensitivity error and maximum/minimum offset voltage, as that would violate the maximum/minimum total output error specification. Also, 3 sigma distribution values are combined by taking the square root of the sum of the squares. See Application Information section.



	<b>Cosemitech</b>	<b>CH703</b>
	<b>Automotive Product Group</b>	This is advanced information on a new product now in development or undergoing evaluation. Details are subject to change without notice and Cosemitech assumes no obligation for future manufacture of this product. Contact Cosemitech for the latest status.

**Preliminary datasheet REV 0.6**

**CH70305AB5\* Performance Characteristics: T<sub>A</sub> Range L, valid at T<sub>A</sub> = -40°C to 150°C, unless otherwise specified**

Characteristic	Symbol	Test Conditions	Min.	Typ. <sup>1</sup>	Max.	Unit
<b>Nominal Performance</b>						
Supply Voltage	V <sub>CC</sub>		4.5	–	5.5	V
Current-Sensing Range	I <sub>PR</sub>		-5	–	5	A
Sensitivity	Sens	I <sub>PR(min)</sub> < I <sub>P</sub> < I <sub>PR(max)</sub> , V <sub>CC</sub> = 5V	–	400	–	mV/A
Zero-Current Output Voltage	V <sub>IOUT(Q)</sub>	Bidirectional, I <sub>P</sub> = 0 A, V <sub>CC</sub> = 5V	–	V <sub>CC</sub> × 0.5	–	V
<b>Accuracy Performance</b>						
Total Output Error <sup>2</sup>	E <sub>TOT</sub>	I <sub>P</sub> = I <sub>PR(max)</sub> , T <sub>A</sub> = -40°C to 150°C	-3		3	%
<b>Total Output Error Components<sup>3</sup> E<sub>TOT</sub> = E<sub>SENS</sub> + 100 × V<sub>OE</sub>/(Sens × I<sub>P</sub>)</b>						
Sensitivity Error	E <sub>sens</sub>	I <sub>P</sub> = I <sub>PR(max)</sub> , T <sub>A</sub> = -40°C to 150°C	-2.5		2.5	%
Offset Voltage	V <sub>OE</sub>	I <sub>P</sub> = 0 A, T <sub>A</sub> = -40°C to 150°C	-10	±6	10	mV
<b>Lifetime Drift Characteristics</b>						
Sensitivity Error Lifetime Drift	E <sub>sens_drift</sub>			±1		%
Total Output Error Lifetime Drift	E <sub>tot_drift</sub>			±1		%

<sup>1</sup> Typical values with +/- are 3 sigma values

<sup>2</sup> Percentage of I<sub>P</sub>, with I<sub>P</sub> = I<sub>PR(max)</sub>.

<sup>3</sup> A single part will not have both the maximum/minimum sensitivity error and maximum/minimum offset voltage, as that would violate the maximum/minimum total output error specification. Also, 3 sigma distribution values are combined by taking the square root of the sum of the squares. See Application Information section.

	<b>Cosemitech</b>	<b>CH703</b>
	<b>Automotive Product Group</b>	This is advanced information on a new product now in development or undergoing evaluation. Details are subject to change without notice and Cosemitech assumes no obligation for future manufacture of this product. Contact Cosemitech for the latest status.

**Preliminary datasheet REV 0.6**

**CH70305AB3\* Performance Characteristics: T<sub>A</sub> Range L, valid at T<sub>A</sub> = -40°C to 150°C, unless otherwise specified**

Characteristic	Symbol	Test Conditions	Min.	Typ. <sup>1</sup>	Max.	Unit
<b>Nominal Performance</b>						
Supply Voltage	V <sub>CC</sub>		3	–	3.6	V
Current-Sensing Range	I <sub>PR</sub>		-5	–	5	A
Sensitivity	Sens	I <sub>PR(min)</sub> < I <sub>P</sub> < I <sub>PR(max)</sub> , V <sub>CC</sub> = 3.3V	–	264	–	mV/A
Zero-Current Output Voltage	V <sub>IOUT(Q)</sub>	Bidirectional, I <sub>P</sub> = 0 A, V <sub>CC</sub> = 3.3V	–	V <sub>CC</sub> × 0.5	–	V
<b>Accuracy Performance</b>						
Total Output Error <sup>2</sup>	E <sub>TOT</sub>	I <sub>P</sub> = I <sub>PR(max)</sub> , T <sub>A</sub> = -40°C to 150°C	-3		3	%
<b>Total Output Error Components<sup>3</sup> E<sub>TOT</sub> = E<sub>SENS</sub> + 100 × V<sub>OE</sub>/(Sens × I<sub>P</sub>)</b>						
Sensitivity Error	E <sub>sens</sub>	I <sub>P</sub> = I <sub>PR(max)</sub> , T <sub>A</sub> = -40°C to 150°C	-2.5		2.5	%
Offset Voltage	V <sub>OE</sub>	I <sub>P</sub> = 0 A, T <sub>A</sub> = -40°C to 150°C	-10	±6	10	mV
<b>Lifetime Drift Characteristics</b>						
Sensitivity Error Lifetime Drift	E <sub>sens_drift</sub>			±1		%
Total Output Error Lifetime Drift	E <sub>tot_drift</sub>			±1		%

<sup>1</sup> Typical values with +/- are 3 sigma values

<sup>2</sup> Percentage of I<sub>P</sub>, with I<sub>P</sub> = I<sub>PR(max)</sub>.

<sup>3</sup> A single part will not have both the maximum/minimum sensitivity error and maximum/minimum offset voltage, as that would violate the maximum/minimum total output error specification. Also, 3 sigma distribution values are combined by taking the square root of the sum of the squares. See Application Information section.

	<b>Cosemitech</b>	<b>CH703</b>
	<b>Automotive Product Group</b>	This is advanced information on a new product now in development or undergoing evaluation. Details are subject to change without notice and Cosemitech assumes no obligation for future manufacture of this product. Contact Cosemitech for the latest status.

**Preliminary datasheet REV 0.6**

**CH70305BU5\* Performance Characteristics: T<sub>A</sub> Range L, valid at T<sub>A</sub> = -40°C to 150°C, unless otherwise specified**

Characteristic	Symbol	Test Conditions	Min.	Typ. <sup>1</sup>	Max.	Unit
<b>Nominal Performance</b>						
Supply Voltage	V <sub>CC</sub>		4.5	–	5.5	V
Current-Sensing Range	I <sub>PR</sub>		0	–	5	A
Sensitivity	Sens	I <sub>PR(min)</sub> < I <sub>P</sub> < I <sub>PR(max)</sub>	–	740	–	mV/A
Zero-Current Output Voltage	V <sub>IOUT(Q)</sub>	Unidirectional, I <sub>P</sub> = 0 A	–	0.65	–	V
<b>Accuracy Performance</b>						
Total Output Error <sup>2</sup>	E <sub>TOT</sub>	I <sub>P</sub> = I <sub>PR(max)</sub> , T <sub>A</sub> = -40°C to 150°C	–3		3	%
<b>Total Output Error Components<sup>3</sup> E<sub>TOT</sub> = E<sub>SENS</sub> + 100 × V<sub>OE</sub> / (Sens × I<sub>P</sub>)</b>						
Sensitivity Error	E <sub>sens</sub>	I <sub>P</sub> = I <sub>PR(max)</sub> , T <sub>A</sub> = -40°C to 150°C	–2.5		2.5	%
Offset Voltage	V <sub>OE</sub>	I <sub>P</sub> = 0 A, T <sub>A</sub> = -40°C to 150°C	–15	±7	15	mV
<b>Lifetime Drift Characteristics</b>						
Sensitivity Error Lifetime Drift	E <sub>sens_drift</sub>			±1		%
Total Output Error Lifetime Drift	E <sub>tot_drift</sub>			±1		%

<sup>1</sup> Typical values with +/- are 3 sigma values

<sup>2</sup> Percentage of I<sub>P</sub>, with I<sub>P</sub> = I<sub>PR(max)</sub>.

<sup>3</sup> A single part will not have both the maximum/minimum sensitivity error and maximum/minimum offset voltage, as that would violate the maximum/minimum total output error specification. Also, 3 sigma distribution values are combined by taking the square root of the sum of the squares. See Application Information section.

	<b>Cosemitech</b>	<b>CH703</b>
	<b>Automotive Product Group</b>	This is advanced information on a new product now in development or undergoing evaluation. Details are subject to change without notice and Cosemitech assumes no obligation for future manufacture of this product. Contact Cosemitech for the latest status.

**Preliminary datasheet REV 0.6**

**CH70305BB5\* Performance Characteristics: T<sub>A</sub> Range L, valid at T<sub>A</sub> = -40°C to 150°C, unless otherwise specified**

Characteristic	Symbol	Test Conditions	Min.	Typ. <sup>1</sup>	Max.	Unit
<b>Nominal Performance</b>						
Supply Voltage	V <sub>CC</sub>		4.5	-	5.5	V
Current-Sensing Range	I <sub>PR</sub>		-5	-	5	A
Sensitivity	Sens	I <sub>PR(min)</sub> < I <sub>P</sub> < I <sub>PR(max)</sub>	-	400	-	mV/A
Zero-Current Output Voltage	V <sub>IOUT(Q)</sub>	Bidirectional, I <sub>P</sub> = 0 A	-	2.5	-	V
<b>Accuracy Performance</b>						
Total Output Error <sup>2</sup>	E <sub>TOT</sub>	I <sub>P</sub> = I <sub>PR(max)</sub> , T <sub>A</sub> = -40°C to 150°C	-3		3	%
<b>Total Output Error Components<sup>3</sup> E<sub>TOT</sub> = E<sub>SENS</sub> + 100 × V<sub>OE</sub> / (Sens × I<sub>P</sub>)</b>						
Sensitivity Error	E <sub>sens</sub>	I <sub>P</sub> = I <sub>PR(max)</sub> , T <sub>A</sub> = -40°C to 150°C	-2.5		2.5	%
Offset Voltage	V <sub>OE</sub>	I <sub>P</sub> = 0 A, T <sub>A</sub> = -40°C to 150°C	-10	±6	10	mV
<b>Lifetime Drift Characteristics</b>						
Sensitivity Error Lifetime Drift	E <sub>sens_drift</sub>			±1		%
Total Output Error Lifetime Drift	E <sub>tot_drift</sub>			±1		%

<sup>1</sup> Typical values with +/- are 3 sigma values

<sup>2</sup> Percentage of I<sub>P</sub>, with I<sub>P</sub> = I<sub>PR(max)</sub>.

<sup>3</sup> A single part will not have both the maximum/minimum sensitivity error and maximum/minimum offset voltage, as that would violate the maximum/minimum total output error specification. Also, 3 sigma distribution values are combined by taking the square root of the sum of the squares. See Application Information section.

	<b>Cosemitech</b>	<b>CH703</b>
	<b>Automotive Product Group</b>	This is advanced information on a new product now in development or undergoing evaluation. Details are subject to change without notice and Cosemitech assumes no obligation for future manufacture of this product. Contact Cosemitech for the latest status.

**Preliminary datasheet REV 0.6**

**CH70305CU5\* Performance Characteristics: T<sub>A</sub> Range L, valid at T<sub>A</sub> = -40°C to 150°C, unless otherwise specified**

Characteristic	Symbol	Test Conditions	Min.	Typ. <sup>1</sup>	Max.	Unit
<b>Nominal Performance</b>						
Supply Voltage	V <sub>CC</sub>		4.5	–	5.5	V
Current-Sensing Range	I <sub>PR</sub>		0	–	5	A
Sensitivity	Sens	I <sub>PR(min)</sub> < I <sub>P</sub> < I <sub>PR(max)</sub>	–	480	–	mV/A
Zero-Current Output Voltage	V <sub>IOUT(Q)</sub>	Unidirectional, I <sub>P</sub> = 0 A	–	0.45	–	V
<b>Accuracy Performance</b>						
Total Output Error <sup>2</sup>	E <sub>TOT</sub>	I <sub>P</sub> = I <sub>PR(max)</sub> , T <sub>A</sub> = -40°C to 150°C	-3		3	%
<b>Total Output Error Components<sup>3</sup> E<sub>TOT</sub> = E<sub>SENS</sub> + 100 × V<sub>OE</sub>/(Sens × I<sub>P</sub>)</b>						
Sensitivity Error	E <sub>sens</sub>	I <sub>P</sub> = I <sub>PR(max)</sub> , T <sub>A</sub> = -40°C to 150°C	-2.5		2.5	%
Offset Voltage	V <sub>OE</sub>	I <sub>P</sub> = 0 A, T <sub>A</sub> = -40°C to 150°C	-15	±7	15	mV
<b>Lifetime Drift Characteristics</b>						
Sensitivity Error Lifetime Drift	E <sub>sens_drift</sub>			±1		%
Total Output Error Lifetime Drift	E <sub>tot_drift</sub>			±1		%

<sup>1</sup> Typical values with +/- are 3 sigma values

<sup>2</sup> Percentage of I<sub>P</sub>, with I<sub>P</sub> = I<sub>PR(max)</sub>.

<sup>3</sup> A single part will not have both the maximum/minimum sensitivity error and maximum/minimum offset voltage, as that would violate the maximum/minimum total output error specification. Also, 3 sigma distribution values are combined by taking the square root of the sum of the squares. See Application Information section.

	<b>Cosemitech</b>	<b>CH703</b>
	<b>Automotive Product Group</b>	This is advanced information on a new product now in development or undergoing evaluation. Details are subject to change without notice and Cosemitech assumes no obligation for future manufacture of this product. Contact Cosemitech for the latest status.

**Preliminary datasheet REV 0.6**

**CH70305CU3\* Performance Characteristics: T<sub>A</sub> Range L, valid at T<sub>A</sub> = -40°C to 150°C, unless otherwise specified**

Characteristic	Symbol	Test Conditions	Min.	Typ. <sup>1</sup>	Max.	Unit
<b>Nominal Performance</b>						
Supply Voltage	V <sub>CC</sub>		3	–	3.6	V
Current-Sensing Range	I <sub>PR</sub>		0	–	5	A
Sensitivity	Sens	I <sub>PR(min)</sub> < I <sub>P</sub> < I <sub>PR(max)</sub>	–	480	–	mV/A
Zero-Current Output Voltage	V <sub>IOUT(Q)</sub>	Unidirectional, I <sub>P</sub> = 0 A	–	0.45	–	V
<b>Accuracy Performance</b>						
Total Output Error <sup>2</sup>	E <sub>TOT</sub>	I <sub>P</sub> = I <sub>PR(max)</sub> , T <sub>A</sub> = -40°C to 150°C	-3		3	%
<b>Total Output Error Components<sup>3</sup> E<sub>TOT</sub> = E<sub>SENS</sub> + 100 × V<sub>OE</sub>/(Sens × I<sub>P</sub>)</b>						
Sensitivity Error	E <sub>sens</sub>	I <sub>P</sub> = I <sub>PR(max)</sub> , T <sub>A</sub> = -40°C to 150°C	-2.5		2.5	%
Offset Voltage	V <sub>OE</sub>	I <sub>P</sub> = 0 A, T <sub>A</sub> = -40°C to 150°C	-15	±7	15	mV
<b>Lifetime Drift Characteristics</b>						
Sensitivity Error Lifetime Drift	E <sub>sens_drift</sub>			±1		%
Total Output Error Lifetime Drift	E <sub>tot_drift</sub>			±1		%

1 Typical values with +/- are 3 sigma values

2 Percentage of I<sub>P</sub>, with I<sub>P</sub> = I<sub>PR(max)</sub>.

3 A single part will not have both the maximum/minimum sensitivity error and maximum/minimum offset voltage, as that would violate the maximum/minimum total output error specification. Also, 3 sigma distribution values are combined by taking the square root of the sum of the squares. See Application Information section.

	<b>Cosemitech</b>	<b>CH703</b>
	<b>Automotive Product Group</b>	This is advanced information on a new product now in development or undergoing evaluation. Details are subject to change without notice and Cosemitech assumes no obligation for future manufacture of this product. Contact Cosemitech for the latest status.

**Preliminary datasheet REV 0.6**

**CH70305CB5\* Performance Characteristics: T<sub>A</sub> Range L, valid at T<sub>A</sub> = -40°C to 150°C, unless otherwise specified**

Characteristic	Symbol	Test Conditions	Min.	Typ. <sup>1</sup>	Max.	Unit
<b>Nominal Performance</b>						
Supply Voltage	V <sub>CC</sub>		4.5	–	5.5	V
Current-Sensing Range	I <sub>PR</sub>		-5	–	5	A
Sensitivity	Sens	I <sub>PR(min)</sub> < I <sub>P</sub> < I <sub>PR(max)</sub>	–	264	–	mV/A
Zero-Current Output Voltage	V <sub>IOUT(Q)</sub>	Bidirectional, I <sub>P</sub> = 0 A	–	1.65	–	V
<b>Accuracy Performance</b>						
Total Output Error <sup>2</sup>	E <sub>TOT</sub>	I <sub>P</sub> = I <sub>PR(max)</sub> , T <sub>A</sub> = -40°C to 150°C	-3		3	%
<b>Total Output Error Components<sup>3</sup> E<sub>TOT</sub> = E<sub>SENS</sub> + 100 × V<sub>OE</sub>/(Sens × I<sub>P</sub>)</b>						
Sensitivity Error	E <sub>sens</sub>	I <sub>P</sub> = I <sub>PR(max)</sub> , T <sub>A</sub> = -40°C to 150°C	-2.5		2.5	%
Offset Voltage	V <sub>OE</sub>	I <sub>P</sub> = 0 A, T <sub>A</sub> = -40°C to 150°C	-10	±6	10	mV
<b>Lifetime Drift Characteristics</b>						
Sensitivity Error Lifetime Drift	E <sub>sens_drift</sub>			±1		%
Total Output Error Lifetime Drift	E <sub>tot_drift</sub>			±1		%

<sup>1</sup> Typical values with +/- are 3 sigma values

<sup>2</sup> Percentage of I<sub>P</sub>, with I<sub>P</sub> = I<sub>PR(max)</sub>.

<sup>3</sup> A single part will not have both the maximum/minimum sensitivity error and maximum/minimum offset voltage, as that would violate the maximum/minimum total output error specification. Also, 3 sigma distribution values are combined by taking the square root of the sum of the squares. See Application Information section.

	<b>Cosemitech</b>	<b>CH703</b>
	<b>Automotive Product Group</b>	This is advanced information on a new product now in development or undergoing evaluation. Details are subject to change without notice and Cosemitech assumes no obligation for future manufacture of this product. Contact Cosemitech for the latest status.

**Preliminary datasheet REV 0.6**

**CH70305CB3\* Performance Characteristics: T<sub>A</sub> Range L, valid at T<sub>A</sub> = -40°C to 150°C, unless otherwise specified**

Characteristic	Symbol	Test Conditions	Min.	Typ. <sup>1</sup>	Max.	Unit
<b>Nominal Performance</b>						
Supply Voltage	V <sub>CC</sub>		3	–	3.3	V
Current-Sensing Range	I <sub>PR</sub>		-5	–	5	A
Sensitivity	Sens	I <sub>PR(min)</sub> < I <sub>P</sub> < I <sub>PR(max)</sub>	–	264	–	mV/A
Zero-Current Output Voltage	V <sub>IOUT(Q)</sub>	Bidirectional, I <sub>P</sub> = 0 A	–	1.65	–	V
<b>Accuracy Performance</b>						
Total Output Error <sup>2</sup>	E <sub>TOT</sub>	I <sub>P</sub> = I <sub>PR(max)</sub> , T <sub>A</sub> = -40°C to 150°C	-3		3	%
<b>Total Output Error Components<sup>3</sup> E<sub>TOT</sub> = E<sub>SENS</sub> + 100 × V<sub>OE</sub>/(Sens × I<sub>P</sub>)</b>						
Sensitivity Error	E <sub>sens</sub>	I <sub>P</sub> = I <sub>PR(max)</sub> , T <sub>A</sub> = -40°C to 150°C	-2.5		2.5	%
Offset Voltage	V <sub>OE</sub>	I <sub>P</sub> = 0 A, T <sub>A</sub> = -40°C to 150°C	-10	±6	10	mV
<b>Lifetime Drift Characteristics</b>						
Sensitivity Error Lifetime Drift	E <sub>sens_drift</sub>			±1		%
Total Output Error Lifetime Drift	E <sub>tot_drift</sub>			±1		%

<sup>1</sup> Typical values with +/- are 3 sigma values

<sup>2</sup> Percentage of I<sub>P</sub>, with I<sub>P</sub> = I<sub>PR(max)</sub>.

<sup>3</sup> A single part will not have both the maximum/minimum sensitivity error and maximum/minimum offset voltage, as that would violate the maximum/minimum total output error specification. Also, 3 sigma distribution values are combined by taking the square root of the sum of the squares. See Application Information section.



	<b>Cosemitech</b>	<b>CH703</b>
	<b>Automotive Product Group</b>	This is advanced information on a new product now in development or undergoing evaluation. Details are subject to change without notice and Cosemitech assumes no obligation for future manufacture of this product. Contact Cosemitech for the latest status.

**Preliminary datasheet REV 0.6**

**CH70310AU5\* Performance Characteristics: T<sub>A</sub> Range L, valid at T<sub>j</sub> = -40°C to 150°C, unless otherwise specified**

Characteristic	Symbol	Test Conditions	Min.	Typ. <sup>1</sup>	Max.	Unit
<b>Nominal Performance</b>						
Supply Voltage	V <sub>CC</sub>		4.5	–	5.5	V
Current-Sensing Range	I <sub>PR</sub>		0	–	10	A
Sensitivity	Sens	I <sub>PR(min)</sub> < I <sub>P</sub> < I <sub>PR(max)</sub> , VCC = 5V	–	370	–	mV/A
Zero-Current Output Voltage	V <sub>IOUT(Q)</sub>	Unidirectional, I <sub>P</sub> = 0 A, VCC = 5V	–	0.65	–	V
<b>Accuracy Performance</b>						
Total Output Error <sup>2</sup>	E <sub>TOT</sub>	I <sub>P</sub> = I <sub>PR(max)</sub> , T <sub>j</sub> = -40°C to 150°C	-3		3	%
<b>Total Output Error Components<sup>3</sup> E<sub>TOT</sub> = E<sub>SENS</sub> + 100 × V<sub>OE</sub>/(Sens × I<sub>P</sub>)</b>						
Sensitivity Error	E <sub>sens</sub>	I <sub>P</sub> = I <sub>PR(max)</sub> , T <sub>j</sub> = -40°C to 150°C	-2.5		2.5	%
Offset Voltage	V <sub>OE</sub>	I <sub>P</sub> = 0 A, T <sub>j</sub> = -40°C to 150°C	-15	±7	15	mV
<b>Lifetime Drift Characteristics</b>						
Sensitivity Error Lifetime Drift	E <sub>sens_drift</sub>			±1		%
Total Output Error Lifetime Drift	E <sub>tot_drift</sub>			±1		%

<sup>1</sup> Typical values with +/- are 3 sigma values

<sup>2</sup> Percentage of I<sub>P</sub>, with I<sub>P</sub> = I<sub>PR(max)</sub>.

<sup>3</sup> A single part will not have both the maximum/minimum sensitivity error and maximum/minimum offset voltage, as that would violate the maximum/minimum total output error specification. Also, 3 sigma distribution values are combined by taking the square root of the sum of the squares. See Application Information section.

	<b>Cosemitech</b>	<b>CH703</b>
	<b>Automotive Product Group</b>	This is advanced information on a new product now in development or undergoing evaluation. Details are subject to change without notice and Cosemitech assumes no obligation for future manufacture of this product. Contact Cosemitech for the latest status.

**Preliminary datasheet REV 0.6**

**CH70310AU3\* Performance Characteristics: T<sub>A</sub> Range L, valid at T<sub>j</sub> = -40°C to 150°C, unless otherwise specified**

Characteristic	Symbol	Test Conditions	Min.	Typ. <sup>1</sup>	Max.	Unit
<b>Nominal Performance</b>						
Supply Voltage	V <sub>CC</sub>		3	–	3.6	V
Current-Sensing Range	I <sub>PR</sub>		0	–	10	A
Sensitivity	Sens	I <sub>PR(min)</sub> < I <sub>P</sub> < I <sub>PR(max)</sub> , VCC = 3.3V	–	240	–	mV/A
Zero-Current Output Voltage	V <sub>IOUT(Q)</sub>	Unidirectional, I <sub>P</sub> = 0 A, VCC = 3.3V	–	0.65	–	V
<b>Accuracy Performance</b>						
Total Output Error <sup>2</sup>	E <sub>TOT</sub>	I <sub>P</sub> = I <sub>PR(max)</sub> , T <sub>j</sub> = -40°C to 150°C	-3		3	%
<b>Total Output Error Components<sup>3</sup> E<sub>TOT</sub> = E<sub>SENS</sub> + 100 × V<sub>OE</sub>/(Sens × I<sub>P</sub>)</b>						
Sensitivity Error	E <sub>sens</sub>	I <sub>P</sub> = I <sub>PR(max)</sub> , T <sub>j</sub> = -40°C to 150°C	-2.5		2.5	%
Offset Voltage	V <sub>OE</sub>	I <sub>P</sub> = 0 A, T <sub>j</sub> = -40°C to 150°C	-15	±7	15	mV
<b>Lifetime Drift Characteristics</b>						
Sensitivity Error Lifetime Drift	E <sub>sens_drift</sub>			±1		%
Total Output Error Lifetime Drift	E <sub>tot_drift</sub>			±1		%

<sup>1</sup> Typical values with +/- are 3 sigma values

<sup>2</sup> Percentage of I<sub>P</sub>, with I<sub>P</sub> = I<sub>PR(max)</sub>.

<sup>3</sup> A single part will not have both the maximum/minimum sensitivity error and maximum/minimum offset voltage, as that would violate the maximum/minimum total output error specification. Also, 3 sigma distribution values are combined by taking the square root of the sum of the squares. See Application Information section.

	<b>Cosemitech</b>	<b>CH703</b>
	<b>Automotive Product Group</b>	This is advanced information on a new product now in development or undergoing evaluation. Details are subject to change without notice and Cosemitech assumes no obligation for future manufacture of this product. Contact Cosemitech for the latest status.

**Preliminary datasheet REV 0.6**

**CH70310AB5\* Performance Characteristics: T<sub>A</sub> Range L, valid at T<sub>j</sub> = -40°C to 150°C, unless otherwise specified**

Characteristic	Symbol	Test Conditions	Min.	Typ. <sup>1</sup>	Max.	Unit
<b>Nominal Performance</b>						
Supply Voltage	V <sub>CC</sub>		4.5	–	5.5	V
Current-Sensing Range	I <sub>PR</sub>		-10	–	10	A
Sensitivity	Sens	I <sub>PR(min)</sub> < I <sub>P</sub> < I <sub>PR(max)</sub> , VCC = 5V	–	200	–	mV/A
Zero-Current Output Voltage	V <sub>IOUT(Q)</sub>	Bidirectional, I <sub>P</sub> = 0 A, VCC = 5V	–	V <sub>CC</sub> × 0.5	–	V
<b>Accuracy Performance</b>						
Total Output Error <sup>2</sup>	E <sub>TOT</sub>	I <sub>P</sub> = I <sub>PR(max)</sub> , T <sub>j</sub> = -40°C to 150°C	-3		3	%
<b>Total Output Error Components<sup>3</sup> E<sub>TOT</sub> = E<sub>SENS</sub> + 100 × V<sub>OE</sub>/(Sens × I<sub>P</sub>)</b>						
Sensitivity Error	E <sub>sens</sub>	I <sub>P</sub> = I <sub>PR(max)</sub> , T <sub>j</sub> = -40°C to 150°C	-2.5		2.5	%
Offset Voltage	V <sub>OE</sub>	I <sub>P</sub> = 0 A, T <sub>j</sub> = -40°C to 150°C	-10	±6	10	mV
<b>Lifetime Drift Characteristics</b>						
Sensitivity Error Lifetime Drift	E <sub>sens_drift</sub>			±1		%
Total Output Error Lifetime Drift	E <sub>tot_drift</sub>			±1		%

<sup>1</sup> Typical values with +/- are 3 sigma values

<sup>2</sup> Percentage of I<sub>P</sub>, with I<sub>P</sub> = I<sub>PR(max)</sub>.

<sup>3</sup> A single part will not have both the maximum/minimum sensitivity error and maximum/minimum offset voltage, as that would violate the maximum/minimum total output error specification. Also, 3 sigma distribution values are combined by taking the square root of the sum of the squares. See Application Information section.

	<b>Cosemitech</b>	<b>CH703</b>
	<b>Automotive Product Group</b>	This is advanced information on a new product now in development or undergoing evaluation. Details are subject to change without notice and Cosemitech assumes no obligation for future manufacture of this product. Contact Cosemitech for the latest status.

**Preliminary datasheet REV 0.6**

**CH70310AB3\* Performance Characteristics: T<sub>A</sub> Range L, valid at T<sub>j</sub> = -40°C to 150°C, unless otherwise specified**

Characteristic	Symbol	Test Conditions	Min.	Typ. <sup>1</sup>	Max.	Unit
<b>Nominal Performance</b>						
Supply Voltage	V <sub>CC</sub>		3	–	3.6	V
Current-Sensing Range	I <sub>PR</sub>		-10	–	10	A
Sensitivity	Sens	I <sub>PR(min)</sub> < I <sub>P</sub> < I <sub>PR(max)</sub> , VCC = 3.3V	–	132	–	mV/A
Zero-Current Output Voltage	V <sub>IOUT(Q)</sub>	Bidirectional, I <sub>P</sub> = 0 A, VCC = 3.3V	–	V <sub>CC</sub> × 0.5	–	V
<b>Accuracy Performance</b>						
Total Output Error <sup>2</sup>	E <sub>TOT</sub>	I <sub>P</sub> = I <sub>PR(max)</sub> , T <sub>j</sub> = -40°C to 150°C	-3		3	%
<b>Total Output Error Components<sup>3</sup> E<sub>TOT</sub> = E<sub>SENS</sub> + 100 × V<sub>OE</sub> / (Sens × I<sub>P</sub>)</b>						
Sensitivity Error	E <sub>sens</sub>	I <sub>P</sub> = I <sub>PR(max)</sub> , T <sub>j</sub> = -40°C to 150°C	-2.5		2.5	%
Offset Voltage	V <sub>OE</sub>	I <sub>P</sub> = 0 A, T <sub>j</sub> = -40°C to 150°C	-10	±6	10	mV
<b>Lifetime Drift Characteristics</b>						
Sensitivity Error Lifetime Drift	E <sub>sens_drift</sub>			±1		%
Total Output Error Lifetime Drift	E <sub>tot_drift</sub>			±1		%

<sup>1</sup> Typical values with +/- are 3 sigma values

<sup>2</sup> Percentage of I<sub>P</sub>, with I<sub>P</sub> = I<sub>PR(max)</sub>.

<sup>3</sup> A single part will not have both the maximum/minimum sensitivity error and maximum/minimum offset voltage, as that would violate the maximum/minimum total output error specification. Also, 3 sigma distribution values are combined by taking the square root of the sum of the squares. See Application Information section.

	<b>Cosemitech</b>	<b>CH703</b>
	<b>Automotive Product Group</b>	This is advanced information on a new product now in development or undergoing evaluation. Details are subject to change without notice and Cosemitech assumes no obligation for future manufacture of this product. Contact Cosemitech for the latest status.

**Preliminary datasheet REV 0.6**

**CH70310BU5\* Performance Characteristics: T<sub>A</sub> Range L, valid at T<sub>j</sub> = -40°C to 150°C, unless otherwise specified**

Characteristic	Symbol	Test Conditions	Min.	Typ. <sup>1</sup>	Max.	Unit
<b>Nominal Performance</b>						
Supply Voltage	V <sub>CC</sub>		4.5	–	5.5	V
Current-Sensing Range	I <sub>PR</sub>		0	–	10	A
Sensitivity	Sens	I <sub>PR(min)</sub> < I <sub>P</sub> < I <sub>PR(max)</sub>	–	370	–	mV/A
Zero-Current Output Voltage	V <sub>IOUT(Q)</sub>	Unidirectional, I <sub>P</sub> = 0 A	–	0.65	–	V
<b>Accuracy Performance</b>						
Total Output Error <sup>2</sup>	E <sub>TOT</sub>	I <sub>P</sub> = I <sub>PR(max)</sub> , T <sub>j</sub> = -40°C to 150°C	–3		3	%
<b>Total Output Error Components<sup>3</sup> E<sub>TOT</sub> = E<sub>SENS</sub> + 100 × V<sub>OE</sub> / (Sens × I<sub>P</sub>)</b>						
Sensitivity Error	E <sub>sens</sub>	I <sub>P</sub> = I <sub>PR(max)</sub> , T <sub>j</sub> = -40°C to 150°C	–2.5		2.5	%
Offset Voltage	V <sub>OE</sub>	I <sub>P</sub> = 0 A, T <sub>j</sub> = -40°C to 150°C	–15	±7	15	mV
<b>Lifetime Drift Characteristics</b>						
Sensitivity Error Lifetime Drift	E <sub>sens_drift</sub>			±1		%
Total Output Error Lifetime Drift	E <sub>tot_drift</sub>			±1		%

<sup>1</sup> Typical values with +/- are 3 sigma values

<sup>2</sup> Percentage of I<sub>P</sub>, with I<sub>P</sub> = I<sub>PR(max)</sub>.

<sup>3</sup> A single part will not have both the maximum/minimum sensitivity error and maximum/minimum offset voltage, as that would violate the maximum/minimum total output error specification. Also, 3 sigma distribution values are combined by taking the square root of the sum of the squares. See Application Information section.

	<b>Cosemitech</b>	<b>CH703</b>
	<b>Automotive Product Group</b>	This is advanced information on a new product now in development or undergoing evaluation. Details are subject to change without notice and Cosemitech assumes no obligation for future manufacture of this product. Contact Cosemitech for the latest status.

**Preliminary datasheet REV 0.6**

**CH70310BB5\* Performance Characteristics: T<sub>A</sub> Range L, valid at T<sub>j</sub> = -40°C to 150°C, unless otherwise specified**

Characteristic	Symbol	Test Conditions	Min.	Typ. <sup>1</sup>	Max.	Unit
<b>Nominal Performance</b>						
Supply Voltage	V <sub>CC</sub>		4.5	–	5.5	V
Current-Sensing Range	I <sub>PR</sub>		-10	–	10	A
Sensitivity	Sens	I <sub>PR(min)</sub> < I <sub>P</sub> < I <sub>PR(max)</sub>	–	200	–	mV/A
Zero-Current Output Voltage	V <sub>IOUT(Q)</sub>	Bidirectional, I <sub>P</sub> = 0 A	–	2.5	–	V
<b>Accuracy Performance</b>						
Total Output Error <sup>2</sup>	E <sub>TOT</sub>	I <sub>P</sub> = I <sub>PR(max)</sub> , T <sub>j</sub> = -40°C to 150°C	-3		3	%
<b>Total Output Error Components<sup>3</sup> E<sub>TOT</sub> = E<sub>SENS</sub> + 100 × V<sub>OE</sub> / (Sens × I<sub>P</sub>)</b>						
Sensitivity Error	E <sub>sens</sub>	I <sub>P</sub> = I <sub>PR(max)</sub> , T <sub>j</sub> = -40°C to 150°C	-2.5		2.5	%
Offset Voltage	V <sub>OE</sub>	I <sub>P</sub> = 0 A, T <sub>j</sub> = -40°C to 150°C	-10	±6	10	mV
<b>Lifetime Drift Characteristics</b>						
Sensitivity Error Lifetime Drift	E <sub>sens_drift</sub>			±1		%
Total Output Error Lifetime Drift	E <sub>tot_drift</sub>			±1		%

<sup>1</sup> Typical values with +/- are 3 sigma values

<sup>2</sup> Percentage of I<sub>P</sub>, with I<sub>P</sub> = I<sub>PR(max)</sub>.

<sup>3</sup> A single part will not have both the maximum/minimum sensitivity error and maximum/minimum offset voltage, as that would violate the maximum/minimum total output error specification. Also, 3 sigma distribution values are combined by taking the square root of the sum of the squares. See Application Information section.

	<b>Cosemitech</b>	<b>CH703</b>
	<b>Automotive Product Group</b>	This is advanced information on a new product now in development or undergoing evaluation. Details are subject to change without notice and Cosemitech assumes no obligation for future manufacture of this product. Contact Cosemitech for the latest status.

**Preliminary datasheet REV 0.6**

**CH70310CU5\* Performance Characteristics: T<sub>A</sub> Range L, valid at T<sub>j</sub> = -40°C to 150°C, unless otherwise specified**

Characteristic	Symbol	Test Conditions	Min.	Typ. <sup>1</sup>	Max.	Unit
<b>Nominal Performance</b>						
Supply Voltage	V <sub>CC</sub>		4.5	–	5.5	V
Current-Sensing Range	I <sub>PR</sub>		0	–	10	A
Sensitivity	Sens	I <sub>PR(min)</sub> < I <sub>P</sub> < I <sub>PR(max)</sub>	–	240	–	mV/A
Zero-Current Output Voltage	V <sub>IOUT(Q)</sub>	Unidirectional, I <sub>P</sub> = 0 A	–	0.45	–	V
<b>Accuracy Performance</b>						
Total Output Error <sup>2</sup>	E <sub>TOT</sub>	I <sub>P</sub> = I <sub>PR(max)</sub> , T <sub>j</sub> = -40°C to 150°C	–3		3	%
<b>Total Output Error Components<sup>3</sup> E<sub>TOT</sub> = E<sub>SENS</sub> + 100 × V<sub>OE</sub>/(Sens × I<sub>P</sub>)</b>						
Sensitivity Error	E <sub>sens</sub>	I <sub>P</sub> = I <sub>PR(max)</sub> , T <sub>j</sub> = -40°C to 150°C	–2.5		2.5	%
Offset Voltage	V <sub>OE</sub>	I <sub>P</sub> = 0 A, T <sub>j</sub> = -40°C to 150°C	–15	±7	15	mV
<b>Lifetime Drift Characteristics</b>						
Sensitivity Error Lifetime Drift	E <sub>sens_drift</sub>			±1		%
Total Output Error Lifetime Drift	E <sub>tot_drift</sub>			±1		%

<sup>1</sup> Typical values with +/- are 3 sigma values

<sup>2</sup> Percentage of I<sub>P</sub>, with I<sub>P</sub> = I<sub>PR(max)</sub>.

<sup>3</sup> A single part will not have both the maximum/minimum sensitivity error and maximum/minimum offset voltage, as that would violate the maximum/minimum total output error specification. Also, 3 sigma distribution values are combined by taking the square root of the sum of the squares. See Application Information section.

	<b>Cosemitech</b>	<b>CH703</b>
	<b>Automotive Product Group</b>	This is advanced information on a new product now in development or undergoing evaluation. Details are subject to change without notice and Cosemitech assumes no obligation for future manufacture of this product. Contact Cosemitech for the latest status.

**Preliminary datasheet REV 0.6**

**CH70310CU3\* Performance Characteristics: T<sub>A</sub> Range L, valid at T<sub>j</sub> = -40°C to 150°C, unless otherwise specified**

Characteristic	Symbol	Test Conditions	Min.	Typ. <sup>1</sup>	Max.	Unit
<b>Nominal Performance</b>						
Supply Voltage	V <sub>CC</sub>		3	–	3.6	V
Current-Sensing Range	I <sub>PR</sub>		0	–	10	A
Sensitivity	Sens	I <sub>PR(min)</sub> < I <sub>P</sub> < I <sub>PR(max)</sub>	–	240	–	mV/A
Zero-Current Output Voltage	V <sub>IOUT(Q)</sub>	Unidirectional, I <sub>P</sub> = 0 A	–	0.45	–	V
<b>Accuracy Performance</b>						
Total Output Error <sup>2</sup>	E <sub>TOT</sub>	I <sub>P</sub> = I <sub>PR(max)</sub> , T <sub>j</sub> = -40°C to 150°C	-3		3	%
<b>Total Output Error Components<sup>3</sup> E<sub>TOT</sub> = E<sub>SENS</sub> + 100 × V<sub>OE</sub>/(Sens × I<sub>P</sub>)</b>						
Sensitivity Error	E <sub>sens</sub>	I <sub>P</sub> = I <sub>PR(max)</sub> , T <sub>j</sub> = -40°C to 150°C	-2.5		2.5	%
Offset Voltage	V <sub>OE</sub>	I <sub>P</sub> = 0 A, T <sub>j</sub> = -40°C to 150°C	-15	±7	15	mV
<b>Lifetime Drift Characteristics</b>						
Sensitivity Error Lifetime Drift	E <sub>sens_drift</sub>			±1		%
Total Output Error Lifetime Drift	E <sub>tot_drift</sub>			±1		%

<sup>1</sup> Typical values with +/- are 3 sigma values

<sup>2</sup> Percentage of I<sub>P</sub>, with I<sub>P</sub> = I<sub>PR(max)</sub>.

<sup>3</sup> A single part will not have both the maximum/minimum sensitivity error and maximum/minimum offset voltage, as that would violate the maximum/minimum total output error specification. Also, 3 sigma distribution values are combined by taking the square root of the sum of the squares. See Application Information section.



	<b>Cosemitech</b>	<b>CH703</b>
	<b>Automotive Product Group</b>	This is advanced information on a new product now in development or undergoing evaluation. Details are subject to change without notice and Cosemitech assumes no obligation for future manufacture of this product. Contact Cosemitech for the latest status.

**Preliminary datasheet REV 0.6**

**CH70310CB5\* Performance Characteristics: T<sub>A</sub> Range L, valid at T<sub>j</sub> = -40°C to 150°C, unless otherwise specified**

Characteristic	Symbol	Test Conditions	Min.	Typ. <sup>1</sup>	Max.	Unit
<b>Nominal Performance</b>						
Supply Voltage	V <sub>CC</sub>		4.5	–	5.5	V
Current-Sensing Range	I <sub>PR</sub>		-10	–	10	A
Sensitivity	Sens	I <sub>PR(min)</sub> < I <sub>P</sub> < I <sub>PR(max)</sub>	–	132	–	mV/A
Zero-Current Output Voltage	V <sub>IOUT(Q)</sub>	Bidirectional, I <sub>P</sub> = 0 A	–	1.65	–	V
<b>Accuracy Performance</b>						
Total Output Error <sup>2</sup>	E <sub>TOT</sub>	I <sub>P</sub> = I <sub>PR(max)</sub> , T <sub>j</sub> = -40°C to 150°C	-3		3	%
<b>Total Output Error Components<sup>3</sup> E<sub>TOT</sub> = E<sub>SENS</sub> + 100 × V<sub>OE</sub>/(Sens × I<sub>P</sub>)</b>						
Sensitivity Error	E <sub>sens</sub>	I <sub>P</sub> = I <sub>PR(max)</sub> , T <sub>j</sub> = -40°C to 150°C	-2.5		2.5	%
Offset Voltage	V <sub>OE</sub>	I <sub>P</sub> = 0 A, T <sub>j</sub> = -40°C to 150°C	-10	±6	10	mV
<b>Lifetime Drift Characteristics</b>						
Sensitivity Error Lifetime Drift	E <sub>sens_drift</sub>			±1		%
Total Output Error Lifetime Drift	E <sub>tot_drift</sub>			±1		%

<sup>1</sup> Typical values with +/- are 3 sigma values

<sup>2</sup> Percentage of I<sub>P</sub>, with I<sub>P</sub> = I<sub>PR(max)</sub>.

<sup>3</sup> A single part will not have both the maximum/minimum sensitivity error and maximum/minimum offset voltage, as that would violate the maximum/minimum total output error specification. Also, 3 sigma distribution values are combined by taking the square root of the sum of the squares. See Application Information section.

	<b>Cosemitech</b>	<b>CH703</b>
	<b>Automotive Product Group</b>	This is advanced information on a new product now in development or undergoing evaluation. Details are subject to change without notice and Cosemitech assumes no obligation for future manufacture of this product. Contact Cosemitech for the latest status.

**Preliminary datasheet REV 0.6**

**CH70310CB3\* Performance Characteristics: T<sub>A</sub> Range L, valid at T<sub>j</sub> = -40°C to 150°C, unless otherwise specified**

Characteristic	Symbol	Test Conditions	Min.	Typ. <sup>1</sup>	Max.	Unit
<b>Nominal Performance</b>						
Supply Voltage	V <sub>CC</sub>		3	–	3.6	V
Current-Sensing Range	I <sub>PR</sub>		-10	–	10	A
Sensitivity	Sens	I <sub>PR(min)</sub> < I <sub>P</sub> < I <sub>PR(max)</sub>	–	132	–	mV/A
Zero-Current Output Voltage	V <sub>IOUT(Q)</sub>	Bidirectional, I <sub>P</sub> = 0 A	–	1.65	–	V
<b>Accuracy Performance</b>						
Total Output Error <sup>2</sup>	E <sub>TOT</sub>	I <sub>P</sub> = I <sub>PR(max)</sub> , T <sub>j</sub> = -40°C to 150°C	-3		3	%
<b>Total Output Error Components<sup>3</sup> E<sub>TOT</sub> = E<sub>SENS</sub> + 100 × V<sub>OE</sub>/(Sens × I<sub>P</sub>)</b>						
Sensitivity Error	E <sub>sens</sub>	I <sub>P</sub> = I <sub>PR(max)</sub> , T <sub>j</sub> = -40°C to 150°C	-2.5		2.5	%
Offset Voltage	V <sub>OE</sub>	I <sub>P</sub> = 0 A, T <sub>j</sub> = -40°C to 150°C	-10	±6	10	mV
<b>Lifetime Drift Characteristics</b>						
Sensitivity Error Lifetime Drift	E <sub>sens_drift</sub>			±1		%
Total Output Error Lifetime Drift	E <sub>tot_drift</sub>			±1		%

<sup>1</sup> Typical values with +/- are 3 sigma values

<sup>2</sup> Percentage of I<sub>P</sub>, with I<sub>P</sub> = I<sub>PR(max)</sub>.

<sup>3</sup> A single part will not have both the maximum/minimum sensitivity error and maximum/minimum offset voltage, as that would violate the maximum/minimum total output error specification. Also, 3 sigma distribution values are combined by taking the square root of the sum of the squares. See Application Information section.

	<b>Cosemitech</b>	<b>CH703</b>
	<b>Automotive Product Group</b>	This is advanced information on a new product now in development or undergoing evaluation. Details are subject to change without notice and Cosemitech assumes no obligation for future manufacture of this product. Contact Cosemitech for the latest status.

**Preliminary datasheet REV 0.6**

**CH70320AU5\* Performance Characteristics: T<sub>A</sub> Range L, valid at T<sub>A</sub> = -40°C to 150°C, unless otherwise specified**

Characteristic	Symbol	Test Conditions	Min.	Typ. <sup>1</sup>	Max.	Unit
<b>Nominal Performance</b>						
Supply Voltage	V <sub>CC</sub>		4.5	–	5.5	V
Current-Sensing Range	I <sub>PR</sub>		0	–	20	A
Sensitivity	Sens	I <sub>PR(min)</sub> < I <sub>P</sub> < I <sub>PR(max)</sub> , V <sub>CC</sub> = 5V	–	200	–	mV/A
Zero-Current Output Voltage	V <sub>IOUT(Q)</sub>	Unidirectional, I <sub>P</sub> = 0 A, V <sub>CC</sub> = 5V	–	V <sub>CC</sub> × 0.1	–	V
<b>Accuracy Performance</b>						
Total Output Error <sup>2</sup>	E <sub>TOT</sub>	I <sub>P</sub> = I <sub>PR(max)</sub> , T <sub>A</sub> = -40°C to 150°C	–3		3	%
<b>Total Output Error Components<sup>3</sup> E<sub>TOT</sub> = E<sub>SENS</sub> + 100 × V<sub>OE</sub>/(Sens × I<sub>P</sub>)</b>						
Sensitivity Error	E <sub>sens</sub>	I <sub>P</sub> = I <sub>PR(max)</sub> , T <sub>A</sub> = -40°C to 150°C	–2.5		2.5	%
Offset Voltage	V <sub>OE</sub>	I <sub>P</sub> = 0 A, T <sub>A</sub> = -40°C to 150°C	–10	±6	10	mV
<b>Lifetime Drift Characteristics</b>						
Sensitivity Error Lifetime Drift	E <sub>sens_drift</sub>			±1		%
Total Output Error Lifetime Drift	E <sub>tot_drift</sub>			±1		%

<sup>1</sup> Typical values with +/- are 3 sigma values

<sup>2</sup> Percentage of I<sub>P</sub>, with I<sub>P</sub> = I<sub>PR(max)</sub>.

<sup>3</sup> A single part will not have both the maximum/minimum sensitivity error and maximum/minimum offset voltage, as that would violate the maximum/minimum total output error specification. Also, 3 sigma distribution values are combined by taking the square root of the sum of the squares. See Application Information section.

	<b>Cosemitech</b>	<b>CH703</b>
	<b>Automotive Product Group</b>	This is advanced information on a new product now in development or undergoing evaluation. Details are subject to change without notice and Cosemitech assumes no obligation for future manufacture of this product. Contact Cosemitech for the latest status.

**Preliminary datasheet REV 0.6**

**CH70320AU3\* Performance Characteristics: T<sub>A</sub> Range L, valid at T<sub>A</sub> = -40°C to 150°C, unless otherwise specified**

Characteristic	Symbol	Test Conditions	Min.	Typ. <sup>4</sup>	Max.	Unit
<b>Nominal Performance</b>						
Supply Voltage	V <sub>CC</sub>		3	–	3.6	V
Current-Sensing Range	I <sub>PR</sub>		0	–	20	A
Sensitivity	Sens	I <sub>PR(min)</sub> < I <sub>P</sub> < I <sub>PR(max)</sub> , VCC = 3.3V	–	132	–	mV/A
Zero-Current Output Voltage	V <sub>IOUT(Q)</sub>	Unidirectional, I <sub>P</sub> = 0 A, VCC = 3.3V	–	V <sub>CC</sub> × 0.1	–	V
<b>Accuracy Performance</b>						
Total Output Error <sup>5</sup>	E <sub>TOT</sub>	I <sub>P</sub> = I <sub>PR(max)</sub> , T <sub>A</sub> = -40°C to 150°C	-3		3	%
<b>Total Output Error Components<sup>6</sup> E<sub>TOT</sub> = E<sub>SENS</sub> + 100 × V<sub>OE</sub>/(Sens × I<sub>P</sub>)</b>						
Sensitivity Error	E <sub>sens</sub>	I <sub>P</sub> = I <sub>PR(max)</sub> , T <sub>A</sub> = -40°C to 150°C	-2.5		2.5	%
Offset Voltage	V <sub>OE</sub>	I <sub>P</sub> = 0 A, T <sub>J</sub> = -40°C to 150°C	-10	±6	10	mV
<b>Lifetime Drift Characteristics</b>						
Sensitivity Error Lifetime Drift	E <sub>sens_drift</sub>			±1		%
Total Output Error Lifetime Drift	E <sub>tot_drift</sub>			±1		%

<sup>1</sup> Typical values with +/- are 3 sigma values

<sup>2</sup> Percentage of I<sub>P</sub>, with I<sub>P</sub> = I<sub>PR(max)</sub>.

<sup>3</sup> A single part will not have both the maximum/minimum sensitivity error and maximum/minimum offset voltage, as that would violate the maximum/minimum total output error specification. Also, 3 sigma distribution values are combined by taking the square root of the sum of the squares. See Application Information section.

	<b>Cosemitech</b>	<b>CH703</b>
	<b>Automotive Product Group</b>	This is advanced information on a new product now in development or undergoing evaluation. Details are subject to change without notice and Cosemitech assumes no obligation for future manufacture of this product. Contact Cosemitech for the latest status.

**Preliminary datasheet REV 0.6**

**CH70320AB5\* Performance Characteristics: T<sub>A</sub> Range L, valid at T<sub>A</sub> = -40°C to 150°C, unless otherwise specified**

Characteristic	Symbol	Test Conditions	Min.	Typ. <sup>1</sup>	Max.	Unit
<b>Nominal Performance</b>						
Supply Voltage	V <sub>CC</sub>		4.5	–	5.5	V
Current-Sensing Range	I <sub>PR</sub>		-20	–	20	A
Sensitivity	Sens	I <sub>PR(min)</sub> < I <sub>P</sub> < I <sub>PR(max)</sub> , VCC = 5V	–	100	–	mV/A
Zero-Current Output Voltage	V <sub>IOUT(Q)</sub>	Bidirectional, I <sub>P</sub> = 0 A, VCC = 5V	–	V <sub>CC</sub> × 0.5	–	V
<b>Accuracy Performance</b>						
Total Output Error <sup>2</sup>	E <sub>TOT</sub>	I <sub>P</sub> = I <sub>PR(max)</sub> , T <sub>A</sub> = -40°C to 150°C	-3		3	%
<b>Total Output Error Components<sup>3</sup> E<sub>TOT</sub> = E<sub>SENS</sub> + 100 × V<sub>OE</sub>/(Sens × I<sub>P</sub>)</b>						
Sensitivity Error	E <sub>sens</sub>	I <sub>P</sub> = I <sub>PR(max)</sub> , T <sub>A</sub> = -40°C to 150°C	-2.5		2.5	%
Offset Voltage	V <sub>OE</sub>	I <sub>P</sub> = 0 A, T <sub>A</sub> = -40°C to 150°C	-10	±5	10	mV
<b>Lifetime Drift Characteristics</b>						
Sensitivity Error Lifetime Drift	E <sub>sens_drift</sub>			±1		%
Total Output Error Lifetime Drift	E <sub>tot_drift</sub>			±1		%

<sup>1</sup> Typical values with +/- are 3 sigma values

<sup>2</sup> Percentage of I<sub>P</sub>, with I<sub>P</sub> = I<sub>PR(max)</sub>.

<sup>3</sup> A single part will not have both the maximum/minimum sensitivity error and maximum/minimum offset voltage, as that would violate the maximum/minimum total output error specification. Also, 3 sigma distribution values are combined by taking the square root of the sum of the squares. See Application Information section.

	<b>Cosemitech</b>	<b>CH703</b>
	<b>Automotive Product Group</b>	This is advanced information on a new product now in development or undergoing evaluation. Details are subject to change without notice and Cosemitech assumes no obligation for future manufacture of this product. Contact Cosemitech for the latest status.

**Preliminary datasheet REV 0.6**

**CH70320AB3\* Performance Characteristics: T<sub>A</sub> Range L, valid at T<sub>A</sub> = -40°C to 150°C, unless otherwise specified**

Characteristic	Symbol	Test Conditions	Min.	Typ. <sup>1</sup>	Max.	Unit
<b>Nominal Performance</b>						
Supply Voltage	V <sub>CC</sub>		3	–	3.6	V
Current-Sensing Range	I <sub>PR</sub>		-20	–	20	A
Sensitivity	Sens	I <sub>PR(min)</sub> < I <sub>P</sub> < I <sub>PR(max)</sub> , VCC = 3.3V	–	66	–	mV/A
Zero-Current Output Voltage	V <sub>IOUT(Q)</sub>	Bidirectional, I <sub>P</sub> = 0 A, VCC = 3.3V	–	V <sub>CC</sub> × 0.5	–	V
<b>Accuracy Performance</b>						
Total Output Error <sup>2</sup>	E <sub>TOT</sub>	I <sub>P</sub> = I <sub>PR(max)</sub> , T <sub>A</sub> = -40°C to 150°C	-3		3	%
<b>Total Output Error Components<sup>3</sup> E<sub>TOT</sub> = E<sub>SENS</sub> + 100 × V<sub>OE</sub>/(Sens × I<sub>P</sub>)</b>						
Sensitivity Error	E <sub>sens</sub>	I <sub>P</sub> = I <sub>PR(max)</sub> , T <sub>A</sub> = -40°C to 150°C	-2.5		2.5	%
Offset Voltage	V <sub>OE</sub>	I <sub>P</sub> = 0 A, T <sub>A</sub> = -40°C to 150°C	-10	±5	10	mV
<b>Lifetime Drift Characteristics</b>						
Sensitivity Error Lifetime Drift	E <sub>sens_drift</sub>			±1		%
Total Output Error Lifetime Drift	E <sub>tot_drift</sub>			±1		%

<sup>1</sup> Typical values with +/- are 3 sigma values

<sup>2</sup> Percentage of I<sub>P</sub>, with I<sub>P</sub> = I<sub>PR(max)</sub>.

<sup>3</sup> A single part will not have both the maximum/minimum sensitivity error and maximum/minimum offset voltage, as that would violate the maximum/minimum total output error specification. Also, 3 sigma distribution values are combined by taking the square root of the sum of the squares. See Application Information section.

	<b>Cosemitech</b>	<b>CH703</b>
	<b>Automotive Product Group</b>	This is advanced information on a new product now in development or undergoing evaluation. Details are subject to change without notice and Cosemitech assumes no obligation for future manufacture of this product. Contact Cosemitech for the latest status.

**Preliminary datasheet REV 0.6**

**CH70320BU5\* Performance Characteristics: T<sub>A</sub> Range L, valid at T<sub>A</sub> = -40°C to 150°C, unless otherwise specified**

Characteristic	Symbol	Test Conditions	Min.	Typ. <sup>1</sup>	Max.	Unit
<b>Nominal Performance</b>						
Supply Voltage	V <sub>CC</sub>		4.5	–	5.5	V
Current-Sensing Range	I <sub>PR</sub>		0	–	20	A
Sensitivity	Sens	I <sub>PR(min)</sub> < I <sub>P</sub> < I <sub>PR(max)</sub>	–	200	–	mV/A
Zero-Current Output Voltage	V <sub>IOUT(Q)</sub>	Unidirectional, I <sub>P</sub> = 0 A	–	0.5	–	V
<b>Accuracy Performance</b>						
Total Output Error <sup>2</sup>	E <sub>TOT</sub>	I <sub>P</sub> = I <sub>PR(max)</sub> , T <sub>A</sub> = -40°C to 150°C	–3		3	%
<b>Total Output Error Components<sup>3</sup> E<sub>TOT</sub> = E<sub>SENS</sub> + 100 × V<sub>OE</sub> / (Sens × I<sub>P</sub>)</b>						
Sensitivity Error	E <sub>sens</sub>	I <sub>P</sub> = I <sub>PR(max)</sub> , T <sub>A</sub> = -40°C to 150°C	–2.5		2.5	%
Offset Voltage	V <sub>OE</sub>	I <sub>P</sub> = 0 A, T <sub>A</sub> = -40°C to 150°C	–10	±6	10	mV
<b>Lifetime Drift Characteristics</b>						
Sensitivity Error Lifetime Drift	E <sub>sens_drift</sub>			±1		%
Total Output Error Lifetime Drift	E <sub>tot_drift</sub>			±1		%

<sup>1</sup> Typical values with +/- are 3 sigma values

<sup>2</sup> Percentage of I<sub>P</sub>, with I<sub>P</sub> = I<sub>PR(max)</sub>.

<sup>3</sup> A single part will not have both the maximum/minimum sensitivity error and maximum/minimum offset voltage, as that would violate the maximum/minimum total output error specification. Also, 3 sigma distribution values are combined by taking the square root of the sum of the squares. See Application Information section.

	<b>Cosemitech</b>	<b>CH703</b>
	<b>Automotive Product Group</b>	This is advanced information on a new product now in development or undergoing evaluation. Details are subject to change without notice and Cosemitech assumes no obligation for future manufacture of this product. Contact Cosemitech for the latest status.

**Preliminary datasheet REV 0.6**

**CH70320BB5\* Performance Characteristics: T<sub>A</sub> Range L, valid at T<sub>A</sub> = -40°C to 150°C, unless otherwise specified**

Characteristic	Symbol	Test Conditions	Min.	Typ. <sup>1</sup>	Max.	Unit
<b>Nominal Performance</b>						
Supply Voltage	V <sub>CC</sub>		4.5	–	5.5	V
Current-Sensing Range	I <sub>PR</sub>		-20	–	20	A
Sensitivity	Sens	I <sub>PR(min)</sub> < I <sub>P</sub> < I <sub>PR(max)</sub>	–	100	–	mV/A
Zero-Current Output Voltage	V <sub>IOUT(Q)</sub>	Bidirectional, I <sub>P</sub> = 0 A	–	2.5	–	V
<b>Accuracy Performance</b>						
Total Output Error <sup>2</sup>	E <sub>TOT</sub>	I <sub>P</sub> = I <sub>PR(max)</sub> , T <sub>A</sub> = -40°C to 150°C	-3		3	%
<b>Total Output Error Components<sup>3</sup> E<sub>TOT</sub> = E<sub>SENS</sub> + 100 × V<sub>OE</sub> / (Sens × I<sub>P</sub>)</b>						
Sensitivity Error	E <sub>sens</sub>	I <sub>P</sub> = I <sub>PR(max)</sub> , T <sub>A</sub> = -40°C to 150°C	-2.5		2.5	%
Offset Voltage	V <sub>OE</sub>	I <sub>P</sub> = 0 A, T <sub>A</sub> = -40°C to 150°C	-10	±5	10	mV
<b>Lifetime Drift Characteristics</b>						
Sensitivity Error Lifetime Drift	E <sub>sens_drift</sub>			±1		%
Total Output Error Lifetime Drift	E <sub>tot_drift</sub>			±1		%

<sup>1</sup> Typical values with +/- are 3 sigma values

<sup>2</sup> Percentage of I<sub>P</sub>, with I<sub>P</sub> = I<sub>PR(max)</sub>.

<sup>3</sup> A single part will not have both the maximum/minimum sensitivity error and maximum/minimum offset voltage, as that would violate the maximum/minimum total output error specification. Also, 3 sigma distribution values are combined by taking the square root of the sum of the squares. See Application Information section.



	<b>Cosemitech</b>	<b>CH703</b>
	<b>Automotive Product Group</b>	This is advanced information on a new product now in development or undergoing evaluation. Details are subject to change without notice and Cosemitech assumes no obligation for future manufacture of this product. Contact Cosemitech for the latest status.

**Preliminary datasheet REV 0.6**

**CH70320CU5\* Performance Characteristics: T<sub>A</sub> Range L, valid at T<sub>A</sub> = -40°C to 150°C, unless otherwise specified**

Characteristic	Symbol	Test Conditions	Min.	Typ. <sup>1</sup>	Max.	Unit
<b>Nominal Performance</b>						
Supply Voltage	V <sub>CC</sub>		4.5	–	5.5	V
Current-Sensing Range	I <sub>PR</sub>		0	–	20	A
Sensitivity	Sens	I <sub>PR(min)</sub> < I <sub>P</sub> < I <sub>PR(max)</sub>	–	132	–	mV/A
Zero-Current Output Voltage	V <sub>IOUT(Q)</sub>	Unidirectional, I <sub>P</sub> = 0 A	–	0.33	–	V
<b>Accuracy Performance</b>						
Total Output Error <sup>2</sup>	E <sub>TOT</sub>	I <sub>P</sub> = I <sub>PR(max)</sub> , T <sub>A</sub> = -40°C to 150°C	–3		3	%
<b>Total Output Error Components<sup>3</sup> E<sub>TOT</sub> = E<sub>SENS</sub> + 100 × V<sub>OE</sub>/(Sens × I<sub>P</sub>)</b>						
Sensitivity Error	E <sub>sens</sub>	I <sub>P</sub> = I <sub>PR(max)</sub> , T <sub>A</sub> = -40°C to 150°C	–2.5		2.5	%
Offset Voltage	V <sub>OE</sub>	I <sub>P</sub> = 0 A, T <sub>A</sub> = -40°C to 150°C	–10	±6	10	mV
<b>Lifetime Drift Characteristics</b>						
Sensitivity Error Lifetime Drift	E <sub>sens_drift</sub>			±1		%
Total Output Error Lifetime Drift	E <sub>tot_drift</sub>			±1		%

<sup>1</sup> Typical values with +/- are 3 sigma values

<sup>2</sup> Percentage of I<sub>P</sub>, with I<sub>P</sub> = I<sub>PR(max)</sub>.

<sup>3</sup> A single part will not have both the maximum/minimum sensitivity error and maximum/minimum offset voltage, as that would violate the maximum/minimum total output error specification. Also, 3 sigma distribution values are combined by taking the square root of the sum of the squares. See Application Information section.

	<b>Cosemitech</b>	<b>CH703</b>
	<b>Automotive Product Group</b>	This is advanced information on a new product now in development or undergoing evaluation. Details are subject to change without notice and Cosemitech assumes no obligation for future manufacture of this product. Contact Cosemitech for the latest status.

**Preliminary datasheet REV 0.6**

**CH70320CU3\* Performance Characteristics: T<sub>A</sub> Range L, valid at T<sub>A</sub> = -40°C to 150°C, unless otherwise specified**

Characteristic	Symbol	Test Conditions	Min.	Typ. <sup>1</sup>	Max.	Unit
<b>Nominal Performance</b>						
Supply Voltage	V <sub>CC</sub>		3	–	3.6	V
Current-Sensing Range	I <sub>PR</sub>		0	–	20	A
Sensitivity	Sens	I <sub>PR(min)</sub> < I <sub>P</sub> < I <sub>PR(max)</sub>	–	132	–	mV/A
Zero-Current Output Voltage	V <sub>IOUT(Q)</sub>	Unidirectional, I <sub>P</sub> = 0 A	–	0.33	–	V
<b>Accuracy Performance</b>						
Total Output Error <sup>2</sup>	E <sub>TOT</sub>	I <sub>P</sub> = I <sub>PR(max)</sub> , T <sub>A</sub> = -40°C to 150°C	-3		3	%
<b>Total Output Error Components<sup>3</sup> E<sub>TOT</sub> = E<sub>SENS</sub> + 100 × V<sub>OE</sub>/(Sens × I<sub>P</sub>)</b>						
Sensitivity Error	E <sub>sens</sub>	I <sub>P</sub> = I <sub>PR(max)</sub> , T <sub>J</sub> = -40°C to 150°C	-2.5		2.5	%
Offset Voltage	V <sub>OE</sub>	I <sub>P</sub> = 0 A, T <sub>J</sub> = -40°C to 150°C	-10	±6	10	mV
<b>Lifetime Drift Characteristics</b>						
Sensitivity Error Lifetime Drift	E <sub>sens_drift</sub>			±1		%
Total Output Error Lifetime Drift	E <sub>tot_drift</sub>			±1		%

1 Typical values with +/- are 3 sigma values

2 Percentage of I<sub>P</sub>, with I<sub>P</sub> = I<sub>PR(max)</sub>.

3 A single part will not have both the maximum/minimum sensitivity error and maximum/minimum offset voltage, as that would violate the maximum/minimum total output error specification. Also, 3 sigma distribution values are combined by taking the square root of the sum of the squares. See Application Information section.

	<b>Cosemitech</b>	<b>CH703</b>
	<b>Automotive Product Group</b>	This is advanced information on a new product now in development or undergoing evaluation. Details are subject to change without notice and Cosemitech assumes no obligation for future manufacture of this product. Contact Cosemitech for the latest status.

**Preliminary datasheet REV 0.6**

**CH70320CB5\* Performance Characteristics: T<sub>A</sub> Range L, valid at T<sub>A</sub> = -40°C to 150°C, unless otherwise specified**

Characteristic	Symbol	Test Conditions	Min.	Typ. <sup>1</sup>	Max.	Unit
<b>Nominal Performance</b>						
Supply Voltage	V <sub>CC</sub>		4.5	–	5.5	V
Current-Sensing Range	I <sub>PR</sub>		-20	–	20	A
Sensitivity	Sens	I <sub>PR(min)</sub> < I <sub>P</sub> < I <sub>PR(max)</sub>	–	66	–	mV/A
Zero-Current Output Voltage	V <sub>IOUT(Q)</sub>	Bidirectional, I <sub>P</sub> = 0 A	–	1.65	–	V
<b>Accuracy Performance</b>						
Total Output Error <sup>2</sup>	E <sub>TOT</sub>	I <sub>P</sub> = I <sub>PR(max)</sub> , T <sub>A</sub> = -40°C to 150°C	-3		3	%
<b>Total Output Error Components<sup>3</sup> E<sub>TOT</sub> = E<sub>SENS</sub> + 100 × V<sub>OE</sub>/(Sens × I<sub>P</sub>)</b>						
Sensitivity Error	E <sub>sens</sub>	I <sub>P</sub> = I <sub>PR(max)</sub> , T <sub>A</sub> = -40°C to 150°C	-2.5		2.5	%
Offset Voltage	V <sub>OE</sub>	I <sub>P</sub> = 0 A, T <sub>A</sub> = -40°C to 150°C	-10	±5	10	mV
<b>Lifetime Drift Characteristics</b>						
Sensitivity Error Lifetime Drift	E <sub>sens_drift</sub>			±1		%
Total Output Error Lifetime Drift	E <sub>tot_drift</sub>			±1		%

<sup>1</sup> Typical values with +/- are 3 sigma values

<sup>2</sup> Percentage of I<sub>P</sub>, with I<sub>P</sub> = I<sub>PR(max)</sub>.

<sup>3</sup> A single part will not have both the maximum/minimum sensitivity error and maximum/minimum offset voltage, as that would violate the maximum/minimum total output error specification. Also, 3 sigma distribution values are combined by taking the square root of the sum of the squares. See Application Information section.

	<b>Cosemitech</b>	<b>CH703</b>
	<b>Automotive Product Group</b>	This is advanced information on a new product now in development or undergoing evaluation. Details are subject to change without notice and Cosemitech assumes no obligation for future manufacture of this product. Contact Cosemitech for the latest status.

**Preliminary datasheet REV 0.6**

**CH70320CB3\* Performance Characteristics: T<sub>A</sub> Range L, valid at T<sub>A</sub> = -40°C to 150°C, unless otherwise specified**

Characteristic	Symbol	Test Conditions	Min.	Typ. <sup>1</sup>	Max.	Unit
<b>Nominal Performance</b>						
Supply Voltage	V <sub>CC</sub>		3	–	3.3	V
Current-Sensing Range	I <sub>PR</sub>		-20	–	20	A
Sensitivity	Sens	I <sub>PR(min)</sub> < I <sub>P</sub> < I <sub>PR(max)</sub>	–	66	–	mV/A
Zero-Current Output Voltage	V <sub>IOUT(Q)</sub>	Bidirectional, I <sub>P</sub> = 0 A	–	1.65	–	V
<b>Accuracy Performance</b>						
Total Output Error <sup>2</sup>	E <sub>TOT</sub>	I <sub>P</sub> = I <sub>PR(max)</sub> , T <sub>A</sub> = -40°C to 150°C	-3		3	%
<b>Total Output Error Components<sup>3</sup> E<sub>TOT</sub> = E<sub>SENS</sub> + 100 × V<sub>OE</sub>/(Sens × I<sub>P</sub>)</b>						
Sensitivity Error	E <sub>sens</sub>	I <sub>P</sub> = I <sub>PR(max)</sub> , T <sub>A</sub> = -40°C to 150°C	-2.5		2.5	%
Offset Voltage	V <sub>OE</sub>	I <sub>P</sub> = 0 A, T <sub>A</sub> = -40°C to 150°C	-10	±5	10	mV
<b>Lifetime Drift Characteristics</b>						
Sensitivity Error Lifetime Drift	E <sub>sens_drift</sub>			±1		%
Total Output Error Lifetime Drift	E <sub>tot_drift</sub>			±1		%

<sup>1</sup> Typical values with +/- are 3 sigma values

<sup>2</sup> Percentage of I<sub>P</sub>, with I<sub>P</sub> = I<sub>PR(max)</sub>.

<sup>3</sup> A single part will not have both the maximum/minimum sensitivity error and maximum/minimum offset voltage, as that would violate the maximum/minimum total output error specification. Also, 3 sigma distribution values are combined by taking the square root of the sum of the squares. See Application Information section.

	<b>Cosemitech</b>	<b>CH703</b>
	<b>Automotive Product Group</b>	This is advanced information on a new product now in development or undergoing evaluation. Details are subject to change without notice and Cosemitech assumes no obligation for future manufacture of this product. Contact Cosemitech for the latest status.

**Preliminary datasheet REV 0.6**

**CH70330AU5\* Performance Characteristics: T<sub>A</sub> Range L, valid at T<sub>j</sub> = -40°C to 150°C, unless otherwise specified**

Characteristic	Symbol	Test Conditions	Min.	Typ. <sup>1</sup>	Max.	Unit
<b>Nominal Performance</b>						
Supply Voltage	V <sub>CC</sub>		4.5	–	5.5	V
Current-Sensing Range	I <sub>PR</sub>		0	–	30	A
Sensitivity	Sens	I <sub>PR(min)</sub> < I <sub>P</sub> < I <sub>PR(max)</sub> , VCC = 5V	–	133	–	mV/A
Zero-Current Output Voltage	V <sub>IOUT(Q)</sub>	Unidirectional, I <sub>P</sub> = 0 A, VCC = 5V	–	V <sub>CC</sub> × 0.1	–	V
<b>Accuracy Performance</b>						
Total Output Error <sup>2</sup>	E <sub>TOT</sub>	I <sub>P</sub> = I <sub>PR(max)</sub> , T <sub>j</sub> = -40°C to 150°C	-3		3	%
<b>Total Output Error Components<sup>3</sup> E<sub>TOT</sub> = E<sub>SENS</sub> + 100 × V<sub>OE</sub>/(Sens × I<sub>P</sub>)</b>						
Sensitivity Error	E <sub>sens</sub>	I <sub>P</sub> = I <sub>PR(max)</sub> , T <sub>j</sub> = -40°C to 150°C	-2.5		2.5	%
Offset Voltage	V <sub>OE</sub>	I <sub>P</sub> = 0 A, T <sub>j</sub> = -40°C to 150°C	-10	±6	10	mV
<b>Lifetime Drift Characteristics</b>						
Sensitivity Error Lifetime Drift	E <sub>sens_drift</sub>			±1		%
Total Output Error Lifetime Drift	E <sub>tot_drift</sub>			±1		%

<sup>1</sup> Typical values with +/- are 3 sigma values

<sup>2</sup> Percentage of I<sub>P</sub>, with I<sub>P</sub> = I<sub>PR(max)</sub>.

<sup>3</sup> A single part will not have both the maximum/minimum sensitivity error and maximum/minimum offset voltage, as that would violate the maximum/minimum total output error specification. Also, 3 sigma distribution values are combined by taking the square root of the sum of the squares. See Application Information section.

	<b>Cosemitech</b>	<b>CH703</b>
	<b>Automotive Product Group</b>	This is advanced information on a new product now in development or undergoing evaluation. Details are subject to change without notice and Cosemitech assumes no obligation for future manufacture of this product. Contact Cosemitech for the latest status.

**Preliminary datasheet REV 0.6**

**CH70330AU3\* Performance Characteristics: T<sub>A</sub> Range L, valid at T<sub>j</sub> = -40°C to 150°C, unless otherwise specified**

Characteristic	Symbol	Test Conditions	Min.	Typ. <sup>1</sup>	Max.	Unit
<b>Nominal Performance</b>						
Supply Voltage	V <sub>CC</sub>		3	–	3.6	V
Current-Sensing Range	I <sub>PR</sub>		0	–	30	A
Sensitivity	Sens	I <sub>PR(min)</sub> < I <sub>P</sub> < I <sub>PR(max)</sub> , VCC = 3.3V	–	88	–	mV/A
Zero-Current Output Voltage	V <sub>IOUT(Q)</sub>	Unidirectional, I <sub>P</sub> = 0 A, VCC = 3.3V	–	V <sub>CC</sub> × 0.1	–	V
<b>Accuracy Performance</b>						
Total Output Error <sup>2</sup>	E <sub>TOT</sub>	I <sub>P</sub> = I <sub>PR(max)</sub> , T <sub>j</sub> = -40°C to 150°C	–3		3	%
<b>Total Output Error Components<sup>3</sup> E<sub>TOT</sub> = E<sub>SENS</sub> + 100 × V<sub>OE</sub>/(Sens × I<sub>P</sub>)</b>						
Sensitivity Error	E <sub>sens</sub>	I <sub>P</sub> = I <sub>PR(max)</sub> , T <sub>j</sub> = -40°C to 150°C	–2.5		2.5	%
Offset Voltage	V <sub>OE</sub>	I <sub>P</sub> = 0 A, T <sub>j</sub> = -40°C to 150°C	–10	±6	10	mV
<b>Lifetime Drift Characteristics</b>						
Sensitivity Error Lifetime Drift	E <sub>sens_drift</sub>			±1		%
Total Output Error Lifetime Drift	E <sub>tot_drift</sub>			±1		%

<sup>1</sup> Typical values with +/- are 3 sigma values

<sup>2</sup> Percentage of I<sub>P</sub>, with I<sub>P</sub> = I<sub>PR(max)</sub>.

<sup>3</sup> A single part will not have both the maximum/minimum sensitivity error and maximum/minimum offset voltage, as that would violate the maximum/minimum total output error specification. Also, 3 sigma distribution values are combined by taking the square root of the sum of the squares. See Application Information section.

	<b>Cosemitech</b>	<b>CH703</b>
	<b>Automotive Product Group</b>	This is advanced information on a new product now in development or undergoing evaluation. Details are subject to change without notice and Cosemitech assumes no obligation for future manufacture of this product. Contact Cosemitech for the latest status.

**Preliminary datasheet REV 0.6**

**CH70330AB5\* Performance Characteristics: T<sub>A</sub> Range L, valid at T<sub>j</sub> = -40°C to 150°C, unless otherwise specified**

Characteristic	Symbol	Test Conditions	Min.	Typ. <sup>1</sup>	Max.	Unit
<b>Nominal Performance</b>						
Supply Voltage	V <sub>CC</sub>		4.5	–	5.5	V
Current-Sensing Range	I <sub>PR</sub>		-30	–	30	A
Sensitivity	Sens	I <sub>PR(min)</sub> < I <sub>P</sub> < I <sub>PR(max)</sub> , V <sub>CC</sub> = 5V	–	66	–	mV/A
Zero-Current Output Voltage	V <sub>IOUT(Q)</sub>	Bidirectional, I <sub>P</sub> = 0 A, V <sub>CC</sub> = 5V	–	V <sub>CC</sub> × 0.5	–	V
<b>Accuracy Performance</b>						
Total Output Error <sup>2</sup>	E <sub>TOT</sub>	I <sub>P</sub> = I <sub>PR(max)</sub> , T <sub>j</sub> = -40°C to 150°C	-3		3	%
<b>Total Output Error Components<sup>3</sup> E<sub>TOT</sub> = E<sub>SENS</sub> + 100 × V<sub>OE</sub>/(Sens × I<sub>P</sub>)</b>						
Sensitivity Error	E <sub>sens</sub>	I <sub>P</sub> = I <sub>PR(max)</sub> , T <sub>j</sub> = -40°C to 150°C	-2.5		2.5	%
Offset Voltage	V <sub>OE</sub>	I <sub>P</sub> = 0 A, T <sub>j</sub> = -40°C to 150°C	-10	±6	10	mV
<b>Lifetime Drift Characteristics</b>						
Sensitivity Error Lifetime Drift	E <sub>sens_drift</sub>			±1		%
Total Output Error Lifetime Drift	E <sub>tot_drift</sub>			±1		%

<sup>1</sup> Typical values with +/- are 3 sigma values

<sup>2</sup> Percentage of I<sub>P</sub>, with I<sub>P</sub> = I<sub>PR(max)</sub>.

<sup>3</sup> A single part will not have both the maximum/minimum sensitivity error and maximum/minimum offset voltage, as that would violate the maximum/minimum total output error specification. Also, 3 sigma distribution values are combined by taking the square root of the sum of the squares. See Application Information section.

	<b>Cosemitech</b>	<b>CH703</b>
	<b>Automotive Product Group</b>	This is advanced information on a new product now in development or undergoing evaluation. Details are subject to change without notice and Cosemitech assumes no obligation for future manufacture of this product. Contact Cosemitech for the latest status.

**Preliminary datasheet REV 0.6**

**CH70330AB3\* Performance Characteristics: T<sub>A</sub> Range L, valid at T<sub>j</sub> = -40°C to 150°C, unless otherwise specified**

Characteristic	Symbol	Test Conditions	Min.	Typ. <sup>1</sup>	Max.	Unit
<b>Nominal Performance</b>						
Supply Voltage	V <sub>CC</sub>		3	–	3.6	V
Current-Sensing Range	I <sub>PR</sub>		-30	–	30	A
Sensitivity	Sens	I <sub>PR(min)</sub> < I <sub>P</sub> < I <sub>PR(max)</sub> , VCC = 3.3V	–	44	–	mV/A
Zero-Current Output Voltage	V <sub>IOUT(Q)</sub>	Bidirectional, I <sub>P</sub> = 0 A, VCC = 3.3V	–	V <sub>CC</sub> × 0.5	–	V
<b>Accuracy Performance</b>						
Total Output Error <sup>2</sup>	E <sub>TOT</sub>	I <sub>P</sub> = I <sub>PR(max)</sub> , T <sub>j</sub> = -40°C to 150°C	-3		3	%
<b>Total Output Error Components<sup>3</sup> E<sub>TOT</sub> = E<sub>SENS</sub> + 100 × V<sub>OE</sub>/(Sens × I<sub>P</sub>)</b>						
Sensitivity Error	E <sub>sens</sub>	I <sub>P</sub> = I <sub>PR(max)</sub> , T <sub>j</sub> = -40°C to 150°C	-2.5		2.5	%
Offset Voltage	V <sub>OE</sub>	I <sub>P</sub> = 0 A, T <sub>j</sub> = -40°C to 150°C	-10	±6	10	mV
<b>Lifetime Drift Characteristics</b>						
Sensitivity Error Lifetime Drift	E <sub>sens_drift</sub>			±1		%
Total Output Error Lifetime Drift	E <sub>tot_drift</sub>			±1		%

<sup>1</sup> Typical values with +/- are 3 sigma values

<sup>2</sup> Percentage of I<sub>P</sub>, with I<sub>P</sub> = I<sub>PR(max)</sub>.

<sup>3</sup> A single part will not have both the maximum/minimum sensitivity error and maximum/minimum offset voltage, as that would violate the maximum/minimum total output error specification. Also, 3 sigma distribution values are combined by taking the square root of the sum of the squares. See Application Information section.



	<b>Cosemitech</b>	<b>CH703</b>
	<b>Automotive Product Group</b>	This is advanced information on a new product now in development or undergoing evaluation. Details are subject to change without notice and Cosemitech assumes no obligation for future manufacture of this product. Contact Cosemitech for the latest status.

**Preliminary datasheet REV 0.6**

**CH70330BU5\* Performance Characteristics: T<sub>A</sub> Range L, valid at T<sub>j</sub> = -40°C to 150°C, unless otherwise specified**

Characteristic	Symbol	Test Conditions	Min.	Typ. <sup>1</sup>	Max.	Unit
<b>Nominal Performance</b>						
Supply Voltage	V <sub>CC</sub>		4.5	–	5.5	V
Current-Sensing Range	I <sub>PR</sub>		0	–	30	A
Sensitivity	Sens	I <sub>PR(min)</sub> < I <sub>P</sub> < I <sub>PR(max)</sub>	–	133	–	mV/A
Zero-Current Output Voltage	V <sub>IOUT(Q)</sub>	Unidirectional, I <sub>P</sub> = 0 A	–	0.5	–	V
<b>Accuracy Performance</b>						
Total Output Error <sup>2</sup>	E <sub>TOT</sub>	I <sub>P</sub> = I <sub>PR(max)</sub> , T <sub>j</sub> = -40°C to 150°C	-3		3	%
<b>Total Output Error Components<sup>3</sup> E<sub>TOT</sub> = E<sub>SENS</sub> + 100 × V<sub>OE</sub>/(Sens × I<sub>P</sub>)</b>						
Sensitivity Error	E <sub>sens</sub>	I <sub>P</sub> = I <sub>PR(max)</sub> , T <sub>j</sub> = -40°C to 150°C	-2.5		2.5	%
Offset Voltage	V <sub>OE</sub>	I <sub>P</sub> = 0 A, T <sub>j</sub> = -40°C to 150°C	-10	±6	10	mV
<b>Lifetime Drift Characteristics</b>						
Sensitivity Error Lifetime Drift	E <sub>sens_drift</sub>			±1		%
Total Output Error Lifetime Drift	E <sub>tot_drift</sub>			±1		%

<sup>1</sup> Typical values with +/- are 3 sigma values

<sup>2</sup> Percentage of I<sub>P</sub>, with I<sub>P</sub> = I<sub>PR(max)</sub>.

<sup>3</sup> A single part will not have both the maximum/minimum sensitivity error and maximum/minimum offset voltage, as that would violate the maximum/minimum total output error specification. Also, 3 sigma distribution values are combined by taking the square root of the sum of the squares. See Application Information section.

	<b>Cosemitech</b>	<b>CH703</b>
	<b>Automotive Product Group</b>	This is advanced information on a new product now in development or undergoing evaluation. Details are subject to change without notice and Cosemitech assumes no obligation for future manufacture of this product. Contact Cosemitech for the latest status.

**Preliminary datasheet REV 0.6**

**CH70330BB5\* Performance Characteristics: T<sub>A</sub> Range L, valid at T<sub>j</sub> = -40°C to 150°C, unless otherwise specified**

Characteristic	Symbol	Test Conditions	Min.	Typ. <sup>1</sup>	Max.	Unit
<b>Nominal Performance</b>						
Supply Voltage	V <sub>CC</sub>		4.5	–	5.5	V
Current-Sensing Range	I <sub>PR</sub>		-30	–	30	A
Sensitivity	Sens	I <sub>PR(min)</sub> < I <sub>P</sub> < I <sub>PR(max)</sub>	–	66	–	mV/A
Zero-Current Output Voltage	V <sub>IOUT(Q)</sub>	Bidirectional, I <sub>P</sub> = 0 A	–	2.5	–	V
<b>Accuracy Performance</b>						
Total Output Error <sup>2</sup>	E <sub>TOT</sub>	I <sub>P</sub> = I <sub>PR(max)</sub> , T <sub>j</sub> = -40°C to 150°C	-3		3	%
<b>Total Output Error Components<sup>3</sup> E<sub>TOT</sub> = E<sub>SENS</sub> + 100 × V<sub>OE</sub>/(Sens × I<sub>P</sub>)</b>						
Sensitivity Error	E <sub>sens</sub>	I <sub>P</sub> = I <sub>PR(max)</sub> , T <sub>j</sub> = -40°C to 150°C	-2.5		2.5	%
Offset Voltage	V <sub>OE</sub>	I <sub>P</sub> = 0 A, T <sub>j</sub> = -40°C to 150°C	-10	±5	10	mV
<b>Lifetime Drift Characteristics</b>						
Sensitivity Error Lifetime Drift	E <sub>sens_drift</sub>			±1		%
Total Output Error Lifetime Drift	E <sub>tot_drift</sub>			±1		%

<sup>1</sup> Typical values with +/- are 3 sigma values

<sup>2</sup> Percentage of I<sub>P</sub>, with I<sub>P</sub> = I<sub>PR(max)</sub>.

<sup>3</sup> A single part will not have both the maximum/minimum sensitivity error and maximum/minimum offset voltage, as that would violate the maximum/minimum total output error specification. Also, 3 sigma distribution values are combined by taking the square root of the sum of the squares. See Application Information section.

	<b>Cosemitech</b>	<b>CH703</b>
	<b>Automotive Product Group</b>	This is advanced information on a new product now in development or undergoing evaluation. Details are subject to change without notice and Cosemitech assumes no obligation for future manufacture of this product. Contact Cosemitech for the latest status.

**Preliminary datasheet REV 0.6**

**CH70330CU5\* Performance Characteristics: T<sub>A</sub> Range L, valid at T<sub>j</sub> = -40°C to 150°C, unless otherwise specified**

Characteristic	Symbol	Test Conditions	Min.	Typ. <sup>1</sup>	Max.	Unit
<b>Nominal Performance</b>						
Supply Voltage	V <sub>CC</sub>		4.5	–	5.5	V
Current-Sensing Range	I <sub>PR</sub>		0	–	30	A
Sensitivity	Sens	I <sub>PR(min)</sub> < I <sub>P</sub> < I <sub>PR(max)</sub>	–	88	–	mV/A
Zero-Current Output Voltage	V <sub>IOUT(Q)</sub>	Unidirectional, I <sub>P</sub> = 0 A	–	0.33	–	V
<b>Accuracy Performance</b>						
Total Output Error <sup>2</sup>	E <sub>TOT</sub>	I <sub>P</sub> = I <sub>PR(max)</sub> , T <sub>j</sub> = -40°C to 150°C	-3		3	%
<b>Total Output Error Components<sup>3</sup> E<sub>TOT</sub> = E<sub>SENS</sub> + 100 × V<sub>OE</sub>/(Sens × I<sub>P</sub>)</b>						
Sensitivity Error	E <sub>sens</sub>	I <sub>P</sub> = I <sub>PR(max)</sub> , T <sub>j</sub> = -40°C to 150°C	-2.5		2.5	%
Offset Voltage	V <sub>OE</sub>	I <sub>P</sub> = 0 A, T <sub>j</sub> = -40°C to 150°C	-10	±6	10	mV
<b>Lifetime Drift Characteristics</b>						
Sensitivity Error Lifetime Drift	E <sub>sens_drift</sub>			±1		%
Total Output Error Lifetime Drift	E <sub>tot_drift</sub>			±1		%

<sup>1</sup> Typical values with +/- are 3 sigma values

<sup>2</sup> Percentage of I<sub>P</sub>, with I<sub>P</sub> = I<sub>PR(max)</sub>.

<sup>3</sup> A single part will not have both the maximum/minimum sensitivity error and maximum/minimum offset voltage, as that would violate the maximum/minimum total output error specification. Also, 3 sigma distribution values are combined by taking the square root of the sum of the squares. See Application Information section.

	<b>Cosemitech</b>	<b>CH703</b>
	<b>Automotive Product Group</b>	This is advanced information on a new product now in development or undergoing evaluation. Details are subject to change without notice and Cosemitech assumes no obligation for future manufacture of this product. Contact Cosemitech for the latest status.

**Preliminary datasheet REV 0.6**

**CH70330CU3\* Performance Characteristics: T<sub>A</sub> Range L, valid at T<sub>j</sub> = -40°C to 150°C, unless otherwise specified**

Characteristic	Symbol	Test Conditions	Min.	Typ. <sup>1</sup>	Max.	Unit
<b>Nominal Performance</b>						
Supply Voltage	V <sub>CC</sub>		3	–	3.6	V
Current-Sensing Range	I <sub>PR</sub>		0	–	30	A
Sensitivity	Sens	I <sub>PR(min)</sub> < I <sub>P</sub> < I <sub>PR(max)</sub>	–	88	–	mV/A
Zero-Current Output Voltage	V <sub>IOUT(Q)</sub>	Unidirectional, I <sub>P</sub> = 0 A	–	0.33	–	V
<b>Accuracy Performance</b>						
Total Output Error <sup>2</sup>	E <sub>TOT</sub>	I <sub>P</sub> = I <sub>PR(max)</sub> , T <sub>j</sub> = -40°C to 150°C	-3		3	%
<b>Total Output Error Components<sup>3</sup> E<sub>TOT</sub> = E<sub>SENS</sub> + 100 × V<sub>OE</sub>/(Sens × I<sub>P</sub>)</b>						
Sensitivity Error	E <sub>sens</sub>	I <sub>P</sub> = I <sub>PR(max)</sub> , T <sub>j</sub> = -40°C to 150°C	-2.5		2.5	%
Offset Voltage	V <sub>OE</sub>	I <sub>P</sub> = 0 A, T <sub>j</sub> = -40°C to 150°C	-10	±6	10	mV
<b>Lifetime Drift Characteristics</b>						
Sensitivity Error Lifetime Drift	E <sub>sens_drift</sub>			±1		%
Total Output Error Lifetime Drift	E <sub>tot_drift</sub>			±1		%

<sup>1</sup> Typical values with +/- are 3 sigma values

<sup>2</sup> Percentage of I<sub>P</sub>, with I<sub>P</sub> = I<sub>PR(max)</sub>.

<sup>3</sup> A single part will not have both the maximum/minimum sensitivity error and maximum/minimum offset voltage, as that would violate the maximum/minimum total output error specification. Also, 3 sigma distribution values are combined by taking the square root of the sum of the squares. See Application Information section.

	<b>Cosemitech</b>	<b>CH703</b>
	<b>Automotive Product Group</b>	This is advanced information on a new product now in development or undergoing evaluation. Details are subject to change without notice and Cosemitech assumes no obligation for future manufacture of this product. Contact Cosemitech for the latest status.

**Preliminary datasheet REV 0.6**

**CH70330CB5\* Performance Characteristics: T<sub>A</sub> Range L, valid at T<sub>j</sub> = -40°C to 150°C, unless otherwise specified**

Characteristic	Symbol	Test Conditions	Min.	Typ. <sup>1</sup>	Max.	Unit
<b>Nominal Performance</b>						
Supply Voltage	V <sub>CC</sub>		4.5	–	5.5	V
Current-Sensing Range	I <sub>PR</sub>		-30	–	30	A
Sensitivity	Sens	I <sub>PR(min)</sub> < I <sub>P</sub> < I <sub>PR(max)</sub>	–	44	–	mV/A
Zero-Current Output Voltage	V <sub>IOUT(Q)</sub>	Bidirectional, I <sub>P</sub> = 0 A	–	1.65	–	V
<b>Accuracy Performance</b>						
Total Output Error <sup>2</sup>	E <sub>TOT</sub>	I <sub>P</sub> = I <sub>PR(max)</sub> , T <sub>j</sub> = -40°C to 150°C	-3		3	%
<b>Total Output Error Components<sup>3</sup> E<sub>TOT</sub> = E<sub>SENS</sub> + 100 × V<sub>OE</sub>/(Sens × I<sub>P</sub>)</b>						
Sensitivity Error	E <sub>sens</sub>	I <sub>P</sub> = I <sub>PR(max)</sub> , T <sub>j</sub> = -40°C to 150°C	-2.5		2.5	%
Offset Voltage	V <sub>OE</sub>	I <sub>P</sub> = 0 A, T <sub>j</sub> = -40°C to 150°C	-10	±5	10	mV
<b>Lifetime Drift Characteristics</b>						
Sensitivity Error Lifetime Drift	E <sub>sens_drift</sub>			±1		%
Total Output Error Lifetime Drift	E <sub>tot_drift</sub>			±1		%

<sup>1</sup> Typical values with +/- are 3 sigma values

<sup>2</sup> Percentage of I<sub>P</sub>, with I<sub>P</sub> = I<sub>PR(max)</sub>.

<sup>3</sup> A single part will not have both the maximum/minimum sensitivity error and maximum/minimum offset voltage, as that would violate the maximum/minimum total output error specification. Also, 3 sigma distribution values are combined by taking the square root of the sum of the squares. See Application Information section.

	<b>Cosemitech</b>	<b>CH703</b>
	<b>Automotive Product Group</b>	This is advanced information on a new product now in development or undergoing evaluation. Details are subject to change without notice and Cosemitech assumes no obligation for future manufacture of this product. Contact Cosemitech for the latest status.

**Preliminary datasheet REV 0.6**

**CH70330CB3\* Performance Characteristics: T<sub>A</sub> Range L, valid at T<sub>j</sub> = -40°C to 150°C, unless otherwise specified**

Characteristic	Symbol	Test Conditions	Min.	Typ. <sup>1</sup>	Max.	Unit
<b>Nominal Performance</b>						
Supply Voltage	V <sub>CC</sub>		3	–	3.6	V
Current-Sensing Range	I <sub>PR</sub>		-30	–	30	A
Sensitivity	Sens	I <sub>PR(min)</sub> < I <sub>P</sub> < I <sub>PR(max)</sub>	–	44	–	mV/A
Zero-Current Output Voltage	V <sub>IOUT(Q)</sub>	Bidirectional, I <sub>P</sub> = 0 A	–	1.65	–	V
<b>Accuracy Performance</b>						
Total Output Error <sup>2</sup>	E <sub>TOT</sub>	I <sub>P</sub> = I <sub>PR(max)</sub> , T <sub>j</sub> = -40°C to 150°C	-3		3	%
<b>Total Output Error Components<sup>3</sup> E<sub>TOT</sub> = E<sub>SENS</sub> + 100 × V<sub>OE</sub>/(Sens × I<sub>P</sub>)</b>						
Sensitivity Error	E <sub>sens</sub>	I <sub>P</sub> = I <sub>PR(max)</sub> , T <sub>j</sub> = -40°C to 150°C	-2.5		2.5	%
Offset Voltage	V <sub>OE</sub>	I <sub>P</sub> = 0 A, T <sub>j</sub> = -40°C to 150°C	-10	±5	10	mV
<b>Lifetime Drift Characteristics</b>						
Sensitivity Error Lifetime Drift	E <sub>sens_drift</sub>			±1		%
Total Output Error Lifetime Drift	E <sub>tot_drift</sub>			±1		%

<sup>1</sup> Typical values with +/- are 3 sigma values

<sup>2</sup> Percentage of I<sub>P</sub>, with I<sub>P</sub> = I<sub>PR(max)</sub>.

<sup>3</sup> A single part will not have both the maximum/minimum sensitivity error and maximum/minimum offset voltage, as that would violate the maximum/minimum total output error specification. Also, 3 sigma distribution values are combined by taking the square root of the sum of the squares. See Application Information section.

	<b>Cosemitech</b>	<b>CH703</b>
	<b>Automotive Product Group</b>	This is advanced information on a new product now in development or undergoing evaluation. Details are subject to change without notice and Cosemitech assumes no obligation for future manufacture of this product. Contact Cosemitech for the latest status.

**Preliminary datasheet REV 0.6**

**CH70340AU5\* Performance Characteristics: T<sub>A</sub> Range L, valid at T<sub>j</sub> = -40°C to 150°C, unless otherwise specified**

Characteristic	Symbol	Test Conditions	Min.	Typ. <sup>1</sup>	Max.	Unit
<b>Nominal Performance</b>						
Supply Voltage	V <sub>CC</sub>		4.5	–	5.5	V
Current-Sensing Range	I <sub>PR</sub>		0	–	40	A
Sensitivity	Sens	I <sub>PR(min)</sub> < I <sub>P</sub> < I <sub>PR(max)</sub> , VCC = 5V	–	100	–	mV/A
Zero-Current Output Voltage	V <sub>IOUT(Q)</sub>	Unidirectional, I <sub>P</sub> = 0 A, VCC = 5V	–	V <sub>CC</sub> × 0.1	–	V
<b>Accuracy Performance</b>						
Total Output Error <sup>2</sup>	E <sub>TOT</sub>	I <sub>P</sub> = I <sub>PR(max)</sub> , T <sub>j</sub> = -40°C to 150°C	–3		3	%
<b>Total Output Error Components<sup>3</sup> E<sub>TOT</sub> = E<sub>SENS</sub> + 100 × V<sub>OE</sub> / (Sens × I<sub>P</sub>)</b>						
Sensitivity Error	E <sub>sens</sub>	I <sub>P</sub> = I <sub>PR(max)</sub> , T <sub>j</sub> = -40°C to 150°C	–2.5		2.5	%
Offset Voltage	V <sub>OE</sub>	I <sub>P</sub> = 0 A, T <sub>j</sub> = -40°C to 150°C	–10	±6	10	mV
<b>Lifetime Drift Characteristics</b>						
Sensitivity Error Lifetime Drift	E <sub>sens_drift</sub>			±1		%
Total Output Error Lifetime Drift	E <sub>tot_drift</sub>			±1		%

<sup>1</sup> Typical values with +/- are 3 sigma values

<sup>2</sup> Percentage of I<sub>P</sub>, with I<sub>P</sub> = I<sub>PR(max)</sub>.

<sup>3</sup> A single part will not have both the maximum/minimum sensitivity error and maximum/minimum offset voltage, as that would violate the maximum/minimum total output error specification. Also, 3 sigma distribution values are combined by taking the square root of the sum of the squares. See Application Information section.

	<b>Cosemitech</b>	<b>CH703</b>
	<b>Automotive Product Group</b>	This is advanced information on a new product now in development or undergoing evaluation. Details are subject to change without notice and Cosemitech assumes no obligation for future manufacture of this product. Contact Cosemitech for the latest status.

**Preliminary datasheet REV 0.6**

**CH70340AU3\* Performance Characteristics: T<sub>A</sub> Range L, valid at T<sub>j</sub> = -40°C to 150°C, unless otherwise specified**

Characteristic	Symbol	Test Conditions	Min.	Typ. <sup>1</sup>	Max.	Unit
<b>Nominal Performance</b>						
Supply Voltage	V <sub>CC</sub>		3	–	3.6	V
Current-Sensing Range	I <sub>PR</sub>		0	–	40	A
Sensitivity	Sens	I <sub>PR(min)</sub> < I <sub>P</sub> < I <sub>PR(max)</sub> , VCC = 3.3V	–	66	–	mV/A
Zero-Current Output Voltage	V <sub>IOUT(Q)</sub>	Unidirectional, I <sub>P</sub> = 0 A, VCC = 3.3V	–	V <sub>CC</sub> × 0.1	–	V
<b>Accuracy Performance</b>						
Total Output Error <sup>2</sup>	E <sub>TOT</sub>	I <sub>P</sub> = I <sub>PR(max)</sub> , T <sub>j</sub> = -40°C to 150°C	–3		3	%
<b>Total Output Error Components<sup>3</sup> E<sub>TOT</sub> = E<sub>SENS</sub> + 100 × V<sub>OE</sub>/(Sens × I<sub>P</sub>)</b>						
Sensitivity Error	E <sub>sens</sub>	I <sub>P</sub> = I <sub>PR(max)</sub> , T <sub>j</sub> = -40°C to 150°C	–2.5		2.5	%
Offset Voltage	V <sub>OE</sub>	I <sub>P</sub> = 0 A, T <sub>j</sub> = -40°C to 150°C	–10	±6	10	mV
<b>Lifetime Drift Characteristics</b>						
Sensitivity Error Lifetime Drift	E <sub>sens_drift</sub>			±1		%
Total Output Error Lifetime Drift	E <sub>tot_drift</sub>			±1		%

<sup>1</sup> Typical values with +/- are 3 sigma values

<sup>2</sup> Percentage of I<sub>P</sub>, with I<sub>P</sub> = I<sub>PR(max)</sub>.

<sup>3</sup> A single part will not have both the maximum/minimum sensitivity error and maximum/minimum offset voltage, as that would violate the maximum/minimum total output error specification. Also, 3 sigma distribution values are combined by taking the square root of the sum of the squares. See Application Information section.



	<b>Cosemitech</b>	<b>CH703</b>
	<b>Automotive Product Group</b>	This is advanced information on a new product now in development or undergoing evaluation. Details are subject to change without notice and Cosemitech assumes no obligation for future manufacture of this product. Contact Cosemitech for the latest status.

**Preliminary datasheet REV 0.6**

**CH70340AB5\* Performance Characteristics: T<sub>A</sub> Range L, valid at T<sub>j</sub> = -40°C to 150°C, unless otherwise specified**

Characteristic	Symbol	Test Conditions	Min.	Typ. <sup>1</sup>	Max.	Unit
<b>Nominal Performance</b>						
Supply Voltage	V <sub>CC</sub>		4.5	–	5.5	V
Current-Sensing Range	I <sub>PR</sub>		-40	–	40	A
Sensitivity	Sens	I <sub>PR(min)</sub> < I <sub>P</sub> < I <sub>PR(max)</sub> , V <sub>CC</sub> = 5V	–	50	–	mV/A
Zero-Current Output Voltage	V <sub>IOUT(Q)</sub>	Bidirectional, I <sub>P</sub> = 0 A, V <sub>CC</sub> = 5V	–	V <sub>CC</sub> × 0.5	–	V
<b>Accuracy Performance</b>						
Total Output Error <sup>2</sup>	E <sub>TOT</sub>	I <sub>P</sub> = I <sub>PR(max)</sub> , T <sub>j</sub> = -40°C to 150°C	-3		3	%
<b>Total Output Error Components<sup>3</sup> E<sub>TOT</sub> = E<sub>SENS</sub> + 100 × V<sub>OE</sub>/(Sens × I<sub>P</sub>)</b>						
Sensitivity Error	E <sub>sens</sub>	I <sub>P</sub> = I <sub>PR(max)</sub> , T <sub>j</sub> = -40°C to 150°C	-2.5		2.5	%
Offset Voltage	V <sub>OE</sub>	I <sub>P</sub> = 0 A, T <sub>j</sub> = -40°C to 150°C	-10	±5	10	mV
<b>Lifetime Drift Characteristics</b>						
Sensitivity Error Lifetime Drift	E <sub>sens_drift</sub>			±1		%
Total Output Error Lifetime Drift	E <sub>tot_drift</sub>			±1		%

<sup>1</sup> Typical values with +/- are 3 sigma values

<sup>2</sup> Percentage of I<sub>P</sub>, with I<sub>P</sub> = I<sub>PR(max)</sub>.

<sup>3</sup> A single part will not have both the maximum/minimum sensitivity error and maximum/minimum offset voltage, as that would violate the maximum/minimum total output error specification. Also, 3 sigma distribution values are combined by taking the square root of the sum of the squares. See Application Information section.

	<b>Cosemitech</b>	<b>CH703</b>
	<b>Automotive Product Group</b>	This is advanced information on a new product now in development or undergoing evaluation. Details are subject to change without notice and Cosemitech assumes no obligation for future manufacture of this product. Contact Cosemitech for the latest status.

**Preliminary datasheet REV 0.6**

**CH70340AB3\* Performance Characteristics: T<sub>A</sub> Range L, valid at T<sub>j</sub> = -40°C to 150°C, unless otherwise specified**

Characteristic	Symbol	Test Conditions	Min.	Typ. <sup>1</sup>	Max.	Unit
<b>Nominal Performance</b>						
Supply Voltage	V <sub>CC</sub>		3	–	3.6	V
Current-Sensing Range	I <sub>PR</sub>		-40	–	40	A
Sensitivity	Sens	I <sub>PR(min)</sub> < I <sub>P</sub> < I <sub>PR(max)</sub> , VCC = 3.3V	–	33	–	mV/A
Zero-Current Output Voltage	V <sub>IOUT(Q)</sub>	Bidirectional, I <sub>P</sub> = 0 A, VCC = 3.3V	–	V <sub>CC</sub> × 0.5	–	V
<b>Accuracy Performance</b>						
Total Output Error <sup>2</sup>	E <sub>TOT</sub>	I <sub>P</sub> = I <sub>PR(max)</sub> , T <sub>j</sub> = -40°C to 150°C	-3		3	%
<b>Total Output Error Components<sup>3</sup> E<sub>TOT</sub> = E<sub>SENS</sub> + 100 × V<sub>OE</sub>/(Sens × I<sub>P</sub>)</b>						
Sensitivity Error	E <sub>sens</sub>	I <sub>P</sub> = I <sub>PR(max)</sub> , T <sub>j</sub> = -40°C to 150°C	-2.5		2.5	%
Offset Voltage	V <sub>OE</sub>	I <sub>P</sub> = 0 A, T <sub>j</sub> = -40°C to 150°C	-10	±5	10	mV
<b>Lifetime Drift Characteristics</b>						
Sensitivity Error Lifetime Drift	E <sub>sens_drift</sub>			±1		%
Total Output Error Lifetime Drift	E <sub>tot_drift</sub>			±1		%

<sup>1</sup> Typical values with +/- are 3 sigma values

<sup>2</sup> Percentage of I<sub>P</sub>, with I<sub>P</sub> = I<sub>PR(max)</sub>.

<sup>3</sup> A single part will not have both the maximum/minimum sensitivity error and maximum/minimum offset voltage, as that would violate the maximum/minimum total output error specification. Also, 3 sigma distribution values are combined by taking the square root of the sum of the squares. See Application Information section.

	<b>Cosemitech</b>	<b>CH703</b>
	<b>Automotive Product Group</b>	This is advanced information on a new product now in development or undergoing evaluation. Details are subject to change without notice and Cosemitech assumes no obligation for future manufacture of this product. Contact Cosemitech for the latest status.

**Preliminary datasheet REV 0.6**

**CH70340BU5\* Performance Characteristics: T<sub>A</sub> Range L, valid at T<sub>j</sub> = -40°C to 150°C, unless otherwise specified**

Characteristic	Symbol	Test Conditions	Min.	Typ. <sup>1</sup>	Max.	Unit
<b>Nominal Performance</b>						
Supply Voltage	V <sub>CC</sub>		4.5	–	5.5	V
Current-Sensing Range	I <sub>PR</sub>		0	–	40	A
Sensitivity	Sens	I <sub>PR(min)</sub> < I <sub>P</sub> < I <sub>PR(max)</sub>	–	100	–	mV/A
Zero-Current Output Voltage	V <sub>IOUT(Q)</sub>	Unidirectional, I <sub>P</sub> = 0 A	–	0.5	–	V
<b>Accuracy Performance</b>						
Total Output Error <sup>2</sup>	E <sub>TOT</sub>	I <sub>P</sub> = I <sub>PR(max)</sub> , T <sub>j</sub> = -40°C to 150°C	-3		3	%
<b>Total Output Error Components<sup>3</sup> E<sub>TOT</sub> = E<sub>SENS</sub> + 100 × V<sub>OE</sub>/(Sens × I<sub>P</sub>)</b>						
Sensitivity Error	E <sub>sens</sub>	I <sub>P</sub> = I <sub>PR(max)</sub> , T <sub>j</sub> = -40°C to 150°C	-2.5		2.5	%
Offset Voltage	V <sub>OE</sub>	I <sub>P</sub> = 0 A, T <sub>j</sub> = -40°C to 150°C	-10	±6	10	mV
<b>Lifetime Drift Characteristics</b>						
Sensitivity Error Lifetime Drift	E <sub>sens_drift</sub>			±1		%
Total Output Error Lifetime Drift	E <sub>tot_drift</sub>			±1		%

<sup>1</sup> Typical values with +/- are 3 sigma values

<sup>2</sup> Percentage of I<sub>P</sub>, with I<sub>P</sub> = I<sub>PR(max)</sub>.

<sup>3</sup> A single part will not have both the maximum/minimum sensitivity error and maximum/minimum offset voltage, as that would violate the maximum/minimum total output error specification. Also, 3 sigma distribution values are combined by taking the square root of the sum of the squares. See Application Information section.

	<b>Cosemitech</b>	<b>CH703</b>
	<b>Automotive Product Group</b>	This is advanced information on a new product now in development or undergoing evaluation. Details are subject to change without notice and Cosemitech assumes no obligation for future manufacture of this product. Contact Cosemitech for the latest status.

**Preliminary datasheet REV 0.6**

**CH70340BB5\* Performance Characteristics: T<sub>A</sub> Range L, valid at T<sub>j</sub> = -40°C to 150°C, unless otherwise specified**

Characteristic	Symbol	Test Conditions	Min.	Typ. <sup>1</sup>	Max.	Unit
<b>Nominal Performance</b>						
Supply Voltage	V <sub>CC</sub>		4.5	–	5.5	V
Current-Sensing Range	I <sub>PR</sub>		-40	–	40	A
Sensitivity	Sens	I <sub>PR(min)</sub> < I <sub>P</sub> < I <sub>PR(max)</sub>	–	50	–	mV/A
Zero-Current Output Voltage	V <sub>IOUT(Q)</sub>	Bidirectional, I <sub>P</sub> = 0 A	–	2.5	–	V
<b>Accuracy Performance</b>						
Total Output Error <sup>2</sup>	E <sub>TOT</sub>	I <sub>P</sub> = I <sub>PR(max)</sub> , T <sub>j</sub> = -40°C to 150°C	-3		3	%
<b>Total Output Error Components<sup>3</sup> E<sub>TOT</sub> = E<sub>SENS</sub> + 100 × V<sub>OE</sub>/(Sens × I<sub>P</sub>)</b>						
Sensitivity Error	E <sub>sens</sub>	I <sub>P</sub> = I <sub>PR(max)</sub> , T <sub>j</sub> = -40°C to 150°C	-2.5		2.5	%
Offset Voltage	V <sub>OE</sub>	I <sub>P</sub> = 0 A, T <sub>j</sub> = -40°C to 150°C	-10	±5	10	mV
<b>Lifetime Drift Characteristics</b>						
Sensitivity Error Lifetime Drift	E <sub>sens_drift</sub>			±1		%
Total Output Error Lifetime Drift	E <sub>tot_drift</sub>			±1		%

<sup>1</sup> Typical values with +/- are 3 sigma values

<sup>2</sup> Percentage of I<sub>P</sub>, with I<sub>P</sub> = I<sub>PR(max)</sub>.

<sup>3</sup> A single part will not have both the maximum/minimum sensitivity error and maximum/minimum offset voltage, as that would violate the maximum/minimum total output error specification. Also, 3 sigma distribution values are combined by taking the square root of the sum of the squares. See Application Information section.

	<b>Cosemitech</b>	<b>CH703</b>
	<b>Automotive Product Group</b>	This is advanced information on a new product now in development or undergoing evaluation. Details are subject to change without notice and Cosemitech assumes no obligation for future manufacture of this product. Contact Cosemitech for the latest status.

**Preliminary datasheet REV 0.6**

**CH70340CU5\* Performance Characteristics: T<sub>A</sub> Range L, valid at T<sub>j</sub> = -40°C to 150°C, unless otherwise specified**

Characteristic	Symbol	Test Conditions	Min.	Typ. <sup>1</sup>	Max.	Unit
<b>Nominal Performance</b>						
Supply Voltage	V <sub>CC</sub>		4.5	–	5.5	V
Current-Sensing Range	I <sub>PR</sub>		0	–	40	A
Sensitivity	Sens	I <sub>PR(min)</sub> < I <sub>P</sub> < I <sub>PR(max)</sub>	–	66	–	mV/A
Zero-Current Output Voltage	V <sub>IOUT(Q)</sub>	Unidirectional, I <sub>P</sub> = 0 A	–	0.33	–	V
<b>Accuracy Performance</b>						
Total Output Error <sup>2</sup>	E <sub>TOT</sub>	I <sub>P</sub> = I <sub>PR(max)</sub> , T <sub>j</sub> = -40°C to 150°C	-3		3	%
<b>Total Output Error Components<sup>3</sup> E<sub>TOT</sub> = E<sub>SENS</sub> + 100 × V<sub>OE</sub>/(Sens × I<sub>P</sub>)</b>						
Sensitivity Error	E <sub>sens</sub>	I <sub>P</sub> = I <sub>PR(max)</sub> , T <sub>j</sub> = -40°C to 150°C	-2.5		2.5	%
Offset Voltage	V <sub>OE</sub>	I <sub>P</sub> = 0 A, T <sub>j</sub> = -40°C to 150°C	-10	±6	10	mV
<b>Lifetime Drift Characteristics</b>						
Sensitivity Error Lifetime Drift	E <sub>sens_drift</sub>			±1		%
Total Output Error Lifetime Drift	E <sub>tot_drift</sub>			±1		%

<sup>1</sup> Typical values with +/- are 3 sigma values

<sup>2</sup> Percentage of I<sub>P</sub>, with I<sub>P</sub> = I<sub>PR(max)</sub>.

<sup>3</sup> A single part will not have both the maximum/minimum sensitivity error and maximum/minimum offset voltage, as that would violate the maximum/minimum total output error specification. Also, 3 sigma distribution values are combined by taking the square root of the sum of the squares. See Application Information section.

	<b>Cosemitech</b>	<b>CH703</b>
	<b>Automotive Product Group</b>	This is advanced information on a new product now in development or undergoing evaluation. Details are subject to change without notice and Cosemitech assumes no obligation for future manufacture of this product. Contact Cosemitech for the latest status.

**Preliminary datasheet REV 0.6**

**CH70340CU3\* Performance Characteristics: T<sub>A</sub> Range L, valid at T<sub>j</sub> = -40°C to 150°C, unless otherwise specified**

Characteristic	Symbol	Test Conditions	Min.	Typ. <sup>1</sup>	Max.	Unit
<b>Nominal Performance</b>						
Supply Voltage	V <sub>CC</sub>		3	–	3.6	V
Current-Sensing Range	I <sub>PR</sub>		0	–	40	A
Sensitivity	Sens	I <sub>PR(min)</sub> < I <sub>P</sub> < I <sub>PR(max)</sub>	–	66	–	mV/A
Zero-Current Output Voltage	V <sub>IOUT(Q)</sub>	Unidirectional, I <sub>P</sub> = 0 A	–	0.33	–	V
<b>Accuracy Performance</b>						
Total Output Error <sup>2</sup>	E <sub>TOT</sub>	I <sub>P</sub> = I <sub>PR(max)</sub> , T <sub>j</sub> = -40°C to 150°C	-3		3	%
<b>Total Output Error Components<sup>3</sup> E<sub>TOT</sub> = E<sub>SENS</sub> + 100 × V<sub>OE</sub>/(Sens × I<sub>P</sub>)</b>						
Sensitivity Error	E <sub>sens</sub>	I <sub>P</sub> = I <sub>PR(max)</sub> , T <sub>j</sub> = -40°C to 150°C	-2.5		2.5	%
Offset Voltage	V <sub>OE</sub>	I <sub>P</sub> = 0 A, T <sub>j</sub> = -40°C to 150°C	-10	±6	10	mV
<b>Lifetime Drift Characteristics</b>						
Sensitivity Error Lifetime Drift	E <sub>sens_drift</sub>			±1		%
Total Output Error Lifetime Drift	E <sub>tot_drift</sub>			±1		%

<sup>1</sup> Typical values with +/- are 3 sigma values

<sup>2</sup> Percentage of I<sub>P</sub>, with I<sub>P</sub> = I<sub>PR(max)</sub>.

<sup>3</sup> A single part will not have both the maximum/minimum sensitivity error and maximum/minimum offset voltage, as that would violate the maximum/minimum total output error specification. Also, 3 sigma distribution values are combined by taking the square root of the sum of the squares. See Application Information section.

	<b>Cosemitech</b>	<b>CH703</b>
	<b>Automotive Product Group</b>	This is advanced information on a new product now in development or undergoing evaluation. Details are subject to change without notice and Cosemitech assumes no obligation for future manufacture of this product. Contact Cosemitech for the latest status.

**Preliminary datasheet REV 0.6**

**CH70340CB5\* Performance Characteristics: T<sub>A</sub> Range L, valid at T<sub>j</sub> = -40°C to 150°C, unless otherwise specified**

Characteristic	Symbol	Test Conditions	Min.	Typ. <sup>1</sup>	Max.	Unit
<b>Nominal Performance</b>						
Supply Voltage	V <sub>CC</sub>		4.5	–	5.5	V
Current-Sensing Range	I <sub>PR</sub>		-40	–	40	A
Sensitivity	Sens	I <sub>PR(min)</sub> < I <sub>P</sub> < I <sub>PR(max)</sub>	–	33	–	mV/A
Zero-Current Output Voltage	V <sub>IOUT(Q)</sub>	Bidirectional, I <sub>P</sub> = 0 A	–	1.65	–	V
<b>Accuracy Performance</b>						
Total Output Error <sup>2</sup>	E <sub>TOT</sub>	I <sub>P</sub> = I <sub>PR(max)</sub> , T <sub>j</sub> = -40°C to 150°C	-3		3	%
<b>Total Output Error Components<sup>3</sup> E<sub>TOT</sub> = E<sub>SENS</sub> + 100 × V<sub>OE</sub>/(Sens × I<sub>P</sub>)</b>						
Sensitivity Error	E <sub>sens</sub>	I <sub>P</sub> = I <sub>PR(max)</sub> , T <sub>j</sub> = -40°C to 150°C	-2.5		2.5	%
Offset Voltage	V <sub>OE</sub>	I <sub>P</sub> = 0 A, T <sub>j</sub> = -40°C to 150°C	-10	±5	10	mV
<b>Lifetime Drift Characteristics</b>						
Sensitivity Error Lifetime Drift	E <sub>sens_drift</sub>			±1		%
Total Output Error Lifetime Drift	E <sub>tot_drift</sub>			±1		%

<sup>1</sup> Typical values with +/- are 3 sigma values

<sup>2</sup> Percentage of I<sub>P</sub>, with I<sub>P</sub> = I<sub>PR(max)</sub>.

<sup>3</sup> A single part will not have both the maximum/minimum sensitivity error and maximum/minimum offset voltage, as that would violate the maximum/minimum total output error specification. Also, 3 sigma distribution values are combined by taking the square root of the sum of the squares. See Application Information section.

	<b>Cosemitech</b>	<b>CH703</b>
	<b>Automotive Product Group</b>	This is advanced information on a new product now in development or undergoing evaluation. Details are subject to change without notice and Cosemitech assumes no obligation for future manufacture of this product. Contact Cosemitech for the latest status.

**Preliminary datasheet REV 0.6**

**CH70340CB3\* Performance Characteristics: T<sub>A</sub> Range L, valid at T<sub>j</sub> = -40°C to 150°C, unless otherwise specified**

Characteristic	Symbol	Test Conditions	Min.	Typ. <sup>1</sup>	Max.	Unit
<b>Nominal Performance</b>						
Supply Voltage	V <sub>CC</sub>		3	–	3.6	V
Current-Sensing Range	I <sub>PR</sub>		-40	–	40	A
Sensitivity	Sens	I <sub>PR(min)</sub> < I <sub>P</sub> < I <sub>PR(max)</sub>	–	33	–	mV/A
Zero-Current Output Voltage	V <sub>IOUT(Q)</sub>	Bidirectional, I <sub>P</sub> = 0 A	–	1.65	–	V
<b>Accuracy Performance</b>						
Total Output Error <sup>2</sup>	E <sub>TOT</sub>	I <sub>P</sub> = I <sub>PR(max)</sub> , T <sub>j</sub> = -40°C to 150°C	-3		3	%
<b>Total Output Error Components<sup>3</sup> E<sub>TOT</sub> = E<sub>SENS</sub> + 100 × V<sub>OE</sub>/(Sens × I<sub>P</sub>)</b>						
Sensitivity Error	E <sub>sens</sub>	I <sub>P</sub> = I <sub>PR(max)</sub> , T <sub>j</sub> = -40°C to 150°C	-2.5		2.5	%
Offset Voltage	V <sub>OE</sub>	I <sub>P</sub> = 0 A, T <sub>j</sub> = -40°C to 150°C	-10	±5	10	mV
<b>Lifetime Drift Characteristics</b>						
Sensitivity Error Lifetime Drift	E <sub>sens_drift</sub>			±1		%
Total Output Error Lifetime Drift	E <sub>tot_drift</sub>			±1		%

<sup>1</sup> Typical values with +/- are 3 sigma values

<sup>2</sup> Percentage of I<sub>P</sub>, with I<sub>P</sub> = I<sub>PR(max)</sub>.

<sup>3</sup> A single part will not have both the maximum/minimum sensitivity error and maximum/minimum offset voltage, as that would violate the maximum/minimum total output error specification. Also, 3 sigma distribution values are combined by taking the square root of the sum of the squares. See Application Information section.



	<b>Cosemitech</b>	<b>CH703</b>
	<b>Automotive Product Group</b>	This is advanced information on a new product now in development or undergoing evaluation. Details are subject to change without notice and Cosemitech assumes no obligation for future manufacture of this product. Contact Cosemitech for the latest status.

**Preliminary datasheet REV 0.6**

**CH70350AU5\* Performance Characteristics: T<sub>A</sub> Range L, valid at T<sub>j</sub> = -40°C to 150°C, unless otherwise specified**

Characteristic	Symbol	Test Conditions	Min.	Typ. <sup>1</sup>	Max.	Unit
<b>Nominal Performance</b>						
Supply Voltage	V <sub>CC</sub>		4.5	–	5.5	V
Current-Sensing Range	I <sub>PR</sub>		0	–	50	A
Sensitivity	Sens	I <sub>PR(min)</sub> < I <sub>P</sub> < I <sub>PR(max)</sub> , VCC = 5V	–	80	–	mV/A
Zero-Current Output Voltage	V <sub>IOUT(Q)</sub>	Unidirectional, I <sub>P</sub> = 0 A, VCC = 5V	–	V <sub>CC</sub> × 0.1	–	V
<b>Accuracy Performance</b>						
Total Output Error <sup>2</sup>	E <sub>TOT</sub>	I <sub>P</sub> = I <sub>PR(max)</sub> , T <sub>j</sub> = -40°C to 150°C	–3		3	%
<b>Total Output Error Components<sup>3</sup> E<sub>TOT</sub> = E<sub>SENS</sub> + 100 × V<sub>OE</sub>/(Sens × I<sub>P</sub>)</b>						
Sensitivity Error	E <sub>sens</sub>	I <sub>P</sub> = I <sub>PR(max)</sub> , T <sub>j</sub> = -40°C to 150°C	–2.5		2.5	%
Offset Voltage	V <sub>OE</sub>	I <sub>P</sub> = 0 A, T <sub>j</sub> = -40°C to 150°C	–10	±6	10	mV
<b>Lifetime Drift Characteristics</b>						
Sensitivity Error Lifetime Drift	E <sub>sens_drift</sub>			±1		%
Total Output Error Lifetime Drift	E <sub>tot_drift</sub>			±1		%

<sup>1</sup> Typical values with +/- are 3 sigma values

<sup>2</sup> Percentage of I<sub>P</sub>, with I<sub>P</sub> = I<sub>PR(max)</sub>.

<sup>3</sup> A single part will not have both the maximum/minimum sensitivity error and maximum/minimum offset voltage, as that would violate the maximum/minimum total output error specification. Also, 3 sigma distribution values are combined by taking the square root of the sum of the squares. See Application Information section.

	<b>Cosemitech</b>	<b>CH703</b>
	<b>Automotive Product Group</b>	This is advanced information on a new product now in development or undergoing evaluation. Details are subject to change without notice and Cosemitech assumes no obligation for future manufacture of this product. Contact Cosemitech for the latest status.

**Preliminary datasheet REV 0.6**

**CH70350AU3\* Performance Characteristics: T<sub>A</sub> Range L, valid at T<sub>j</sub> = -40°C to 150°C, unless otherwise specified**

Characteristic	Symbol	Test Conditions	Min.	Typ. <sup>1</sup>	Max.	Unit
<b>Nominal Performance</b>						
Supply Voltage	V <sub>CC</sub>		3	–	3.6	V
Current-Sensing Range	I <sub>PR</sub>		0	–	50	A
Sensitivity	Sens	I <sub>PR(min)</sub> < I <sub>P</sub> < I <sub>PR(max)</sub> , VCC = 3.3V	–	52	–	mV/A
Zero-Current Output Voltage	V <sub>IOUT(Q)</sub>	Unidirectional, I <sub>P</sub> = 0 A, VCC = 3.3V	–	V <sub>CC</sub> × 0.1	–	V
<b>Accuracy Performance</b>						
Total Output Error <sup>2</sup>	E <sub>TOT</sub>	I <sub>P</sub> = I <sub>PR(max)</sub> , T <sub>j</sub> = -40°C to 150°C	-3		3	%
<b>Total Output Error Components<sup>3</sup> E<sub>TOT</sub> = E<sub>SENS</sub> + 100 × V<sub>OE</sub> / (Sens × I<sub>P</sub>)</b>						
Sensitivity Error	E <sub>sens</sub>	I <sub>P</sub> = I <sub>PR(max)</sub> , T <sub>j</sub> = -40°C to 150°C	-2.5		2.5	%
Offset Voltage	V <sub>OE</sub>	I <sub>P</sub> = 0 A, T <sub>j</sub> = -40°C to 150°C	-10	±6	10	mV
<b>Lifetime Drift Characteristics</b>						
Sensitivity Error Lifetime Drift	E <sub>sens_drift</sub>			±1		%
Total Output Error Lifetime Drift	E <sub>tot_drift</sub>			±1		%

<sup>1</sup> Typical values with +/- are 3 sigma values

<sup>2</sup> Percentage of I<sub>P</sub>, with I<sub>P</sub> = I<sub>PR(max)</sub>.

<sup>3</sup> A single part will not have both the maximum/minimum sensitivity error and maximum/minimum offset voltage, as that would violate the maximum/minimum total output error specification. Also, 3 sigma distribution values are combined by taking the square root of the sum of the squares. See Application Information section.

	<b>Cosemitech</b>	<b>CH703</b>
	<b>Automotive Product Group</b>	This is advanced information on a new product now in development or undergoing evaluation. Details are subject to change without notice and Cosemitech assumes no obligation for future manufacture of this product. Contact Cosemitech for the latest status.

**Preliminary datasheet REV 0.6**

**CH70350AB5\* Performance Characteristics: T<sub>A</sub> Range L, valid at T<sub>j</sub> = -40°C to 150°C, unless otherwise specified**

Characteristic	Symbol	Test Conditions	Min.	Typ. <sup>1</sup>	Max.	Unit
<b>Nominal Performance</b>						
Supply Voltage	V <sub>CC</sub>		4.5	–	5.5	V
Current-Sensing Range	I <sub>PR</sub>		-50	–	50	A
Sensitivity	Sens	I <sub>PR(min)</sub> < I <sub>P</sub> < I <sub>PR(max)</sub> , V <sub>CC</sub> = 5V	–	40	–	mV/A
Zero-Current Output Voltage	V <sub>IOUT(Q)</sub>	Bidirectional, I <sub>P</sub> = 0 A, V <sub>CC</sub> = 5V	–	V <sub>CC</sub> × 0.5	–	V
<b>Accuracy Performance</b>						
Total Output Error <sup>2</sup>	E <sub>TOT</sub>	I <sub>P</sub> = I <sub>PR(max)</sub> , T <sub>j</sub> = -40°C to 150°C	-3		3	%
<b>Total Output Error Components<sup>3</sup> E<sub>TOT</sub> = E<sub>SENS</sub> + 100 × V<sub>OE</sub>/(Sens × I<sub>P</sub>)</b>						
Sensitivity Error	E <sub>sens</sub>	I <sub>P</sub> = I <sub>PR(max)</sub> , T <sub>j</sub> = -40°C to 150°C	-2.5		2.5	%
Offset Voltage	V <sub>OE</sub>	I <sub>P</sub> = 0 A, T <sub>j</sub> = -40°C to 150°C	-10	±5	10	mV
<b>Lifetime Drift Characteristics</b>						
Sensitivity Error Lifetime Drift	E <sub>sens_drift</sub>			±1		%
Total Output Error Lifetime Drift	E <sub>tot_drift</sub>			±1		%

<sup>1</sup> Typical values with +/- are 3 sigma values

<sup>2</sup> Percentage of I<sub>P</sub>, with I<sub>P</sub> = I<sub>PR(max)</sub>.

<sup>3</sup> A single part will not have both the maximum/minimum sensitivity error and maximum/minimum offset voltage, as that would violate the maximum/minimum total output error specification. Also, 3 sigma distribution values are combined by taking the square root of the sum of the squares. See Application Information section.

	<b>Cosemitech</b>	<b>CH703</b>
	<b>Automotive Product Group</b>	This is advanced information on a new product now in development or undergoing evaluation. Details are subject to change without notice and Cosemitech assumes no obligation for future manufacture of this product. Contact Cosemitech for the latest status.

**Preliminary datasheet REV 0.6**

**CH70350AB3\* Performance Characteristics: T<sub>A</sub> Range L, valid at T<sub>j</sub> = -40°C to 150°C, unless otherwise specified**

Characteristic	Symbol	Test Conditions	Min.	Typ. <sup>1</sup>	Max.	Unit
<b>Nominal Performance</b>						
Supply Voltage	V <sub>CC</sub>		3	–	3.6	V
Current-Sensing Range	I <sub>PR</sub>		-50	–	50	A
Sensitivity	Sens	I <sub>PR(min)</sub> < I <sub>P</sub> < I <sub>PR(max)</sub> , VCC = 3.3V	–	26	–	mV/A
Zero-Current Output Voltage	V <sub>IOUT(Q)</sub>	Bidirectional, I <sub>P</sub> = 0 A, VCC = 3.3V	–	V <sub>CC</sub> × 0.5	–	V
<b>Accuracy Performance</b>						
Total Output Error <sup>2</sup>	E <sub>TOT</sub>	I <sub>P</sub> = I <sub>PR(max)</sub> , T <sub>j</sub> = -40°C to 150°C	-3		3	%
<b>Total Output Error Components<sup>3</sup> E<sub>TOT</sub> = E<sub>SENS</sub> + 100 × V<sub>OE</sub>/(Sens × I<sub>P</sub>)</b>						
Sensitivity Error	E <sub>sens</sub>	I <sub>P</sub> = I <sub>PR(max)</sub> , T <sub>j</sub> = -40°C to 150°C	-2.5		2.5	%
Offset Voltage	V <sub>OE</sub>	I <sub>P</sub> = 0 A, T <sub>j</sub> = -40°C to 150°C	-10	±5	10	mV
<b>Lifetime Drift Characteristics</b>						
Sensitivity Error Lifetime Drift	E <sub>sens_drift</sub>			±1		%
Total Output Error Lifetime Drift	E <sub>tot_drift</sub>			±1		%

<sup>1</sup> Typical values with +/- are 3 sigma values

<sup>2</sup> Percentage of I<sub>P</sub>, with I<sub>P</sub> = I<sub>PR(max)</sub>.

<sup>3</sup> A single part will not have both the maximum/minimum sensitivity error and maximum/minimum offset voltage, as that would violate the maximum/minimum total output error specification. Also, 3 sigma distribution values are combined by taking the square root of the sum of the squares. See Application Information section.

	<b>Cosemitech</b>	<b>CH703</b>
	<b>Automotive Product Group</b>	This is advanced information on a new product now in development or undergoing evaluation. Details are subject to change without notice and Cosemitech assumes no obligation for future manufacture of this product. Contact Cosemitech for the latest status.

**Preliminary datasheet REV 0.6**

**CH70350BU5\* Performance Characteristics: T<sub>A</sub> Range L, valid at T<sub>j</sub> = -40°C to 150°C, unless otherwise specified**

Characteristic	Symbol	Test Conditions	Min.	Typ. <sup>1</sup>	Max.	Unit
<b>Nominal Performance</b>						
Supply Voltage	V <sub>CC</sub>		4.5	–	5.5	V
Current-Sensing Range	I <sub>PR</sub>		0	–	50	A
Sensitivity	Sens	I <sub>PR(min)</sub> < I <sub>P</sub> < I <sub>PR(max)</sub>	–	80	–	mV/A
Zero-Current Output Voltage	V <sub>IOUT(Q)</sub>	Unidirectional, I <sub>P</sub> = 0 A	–	0.5	–	V
<b>Accuracy Performance</b>						
Total Output Error <sup>2</sup>	E <sub>TOT</sub>	I <sub>P</sub> = I <sub>PR(max)</sub> , T <sub>j</sub> = -40°C to 150°C	-3		3	%
<b>Total Output Error Components<sup>3</sup> E<sub>TOT</sub> = E<sub>SENS</sub> + 100 × V<sub>OE</sub>/(Sens × I<sub>P</sub>)</b>						
Sensitivity Error	E <sub>sens</sub>	I <sub>P</sub> = I <sub>PR(max)</sub> , T <sub>j</sub> = -40°C to 150°C	-2.5		2.5	%
Offset Voltage	V <sub>OE</sub>	I <sub>P</sub> = 0 A, T <sub>j</sub> = -40°C to 150°C	-10	±6	10	mV
<b>Lifetime Drift Characteristics</b>						
Sensitivity Error Lifetime Drift	E <sub>sens_drift</sub>			±1		%
Total Output Error Lifetime Drift	E <sub>tot_drift</sub>			±1		%

<sup>1</sup> Typical values with +/- are 3 sigma values

<sup>2</sup> Percentage of I<sub>P</sub>, with I<sub>P</sub> = I<sub>PR(max)</sub>.

<sup>3</sup> A single part will not have both the maximum/minimum sensitivity error and maximum/minimum offset voltage, as that would violate the maximum/minimum total output error specification. Also, 3 sigma distribution values are combined by taking the square root of the sum of the squares. See Application Information section.

	<b>Cosemitech</b>	<b>CH703</b>
	<b>Automotive Product Group</b>	This is advanced information on a new product now in development or undergoing evaluation. Details are subject to change without notice and Cosemitech assumes no obligation for future manufacture of this product. Contact Cosemitech for the latest status.

**Preliminary datasheet REV 0.6**

**CH70350BB5\* Performance Characteristics: T<sub>A</sub> Range L, valid at T<sub>j</sub> = -40°C to 150°C, unless otherwise specified**

Characteristic	Symbol	Test Conditions	Min.	Typ. <sup>1</sup>	Max.	Unit
<b>Nominal Performance</b>						
Supply Voltage	V <sub>CC</sub>		4.5	–	5.5	V
Current-Sensing Range	I <sub>PR</sub>		-50	–	50	A
Sensitivity	Sens	I <sub>PR(min)</sub> < I <sub>P</sub> < I <sub>PR(max)</sub>	–	40	–	mV/A
Zero-Current Output Voltage	V <sub>IOUT(Q)</sub>	Bidirectional, I <sub>P</sub> = 0 A	–	2.5	–	V
<b>Accuracy Performance</b>						
Total Output Error <sup>2</sup>	E <sub>TOT</sub>	I <sub>P</sub> = I <sub>PR(max)</sub> , T <sub>j</sub> = -40°C to 150°C	-3		3	%
<b>Total Output Error Components<sup>3</sup> E<sub>TOT</sub> = E<sub>SENS</sub> + 100 × V<sub>OE</sub>/(Sens × I<sub>P</sub>)</b>						
Sensitivity Error	E <sub>sens</sub>	I <sub>P</sub> = I <sub>PR(max)</sub> , T <sub>j</sub> = -40°C to 150°C	-2.5		2.5	%
Offset Voltage	V <sub>OE</sub>	I <sub>P</sub> = 0 A, T <sub>j</sub> = -40°C to 150°C	-10	±5	10	mV
<b>Lifetime Drift Characteristics</b>						
Sensitivity Error Lifetime Drift	E <sub>sens_drift</sub>			±1		%
Total Output Error Lifetime Drift	E <sub>tot_drift</sub>			±1		%

<sup>1</sup> Typical values with +/- are 3 sigma values

<sup>2</sup> Percentage of I<sub>P</sub>, with I<sub>P</sub> = I<sub>PR(max)</sub>.

<sup>3</sup> A single part will not have both the maximum/minimum sensitivity error and maximum/minimum offset voltage, as that would violate the maximum/minimum total output error specification. Also, 3 sigma distribution values are combined by taking the square root of the sum of the squares. See Application Information section.

	<b>Cosemitech</b>	<b>CH703</b>
	<b>Automotive Product Group</b>	This is advanced information on a new product now in development or undergoing evaluation. Details are subject to change without notice and Cosemitech assumes no obligation for future manufacture of this product. Contact Cosemitech for the latest status.

**Preliminary datasheet REV 0.6**

**CH70350CU5\* Performance Characteristics: T<sub>A</sub> Range L, valid at T<sub>j</sub> = -40°C to 150°C, unless otherwise specified**

Characteristic	Symbol	Test Conditions	Min.	Typ. <sup>1</sup>	Max.	Unit
<b>Nominal Performance</b>						
Supply Voltage	V <sub>CC</sub>		4.5	–	5.5	V
Current-Sensing Range	I <sub>PR</sub>		0	–	50	A
Sensitivity	Sens	I <sub>PR(min)</sub> < I <sub>P</sub> < I <sub>PR(max)</sub>	–	52	–	mV/A
Zero-Current Output Voltage	V <sub>IOUT(Q)</sub>	Unidirectional, I <sub>P</sub> = 0 A	–	0.33	–	V
<b>Accuracy Performance</b>						
Total Output Error <sup>2</sup>	E <sub>TOT</sub>	I <sub>P</sub> = I <sub>PR(max)</sub> , T <sub>j</sub> = -40°C to 150°C	-3		3	%
<b>Total Output Error Components<sup>3</sup> E<sub>TOT</sub> = E<sub>SENS</sub> + 100 × V<sub>OE</sub>/(Sens × I<sub>P</sub>)</b>						
Sensitivity Error	E <sub>sens</sub>	I <sub>P</sub> = I <sub>PR(max)</sub> , T <sub>j</sub> = -40°C to 150°C	-2.5		2.5	%
Offset Voltage	V <sub>OE</sub>	I <sub>P</sub> = 0 A, T <sub>j</sub> = -40°C to 150°C	-10	±6	10	mV
<b>Lifetime Drift Characteristics</b>						
Sensitivity Error Lifetime Drift	E <sub>sens_drift</sub>			±1		%
Total Output Error Lifetime Drift	E <sub>tot_drift</sub>			±1		%

<sup>1</sup> Typical values with +/- are 3 sigma values

<sup>2</sup> Percentage of I<sub>P</sub>, with I<sub>P</sub> = I<sub>PR(max)</sub>.

<sup>3</sup> A single part will not have both the maximum/minimum sensitivity error and maximum/minimum offset voltage, as that would violate the maximum/minimum total output error specification. Also, 3 sigma distribution values are combined by taking the square root of the sum of the squares. See Application Information section.

	<b>Cosemitech</b>	<b>CH703</b>
	<b>Automotive Product Group</b>	This is advanced information on a new product now in development or undergoing evaluation. Details are subject to change without notice and Cosemitech assumes no obligation for future manufacture of this product. Contact Cosemitech for the latest status.

**Preliminary datasheet REV 0.6**

**CH70350CU3\* Performance Characteristics: T<sub>A</sub> Range L, valid at T<sub>j</sub> = -40°C to 150°C, unless otherwise specified**

Characteristic	Symbol	Test Conditions	Min.	Typ. <sup>1</sup>	Max.	Unit
<b>Nominal Performance</b>						
Supply Voltage	V <sub>CC</sub>		3	–	3.6	V
Current-Sensing Range	I <sub>PR</sub>		0	–	50	A
Sensitivity	Sens	I <sub>PR(min)</sub> < I <sub>P</sub> < I <sub>PR(max)</sub>	–	52	–	mV/A
Zero-Current Output Voltage	V <sub>IOUT(Q)</sub>	Unidirectional, I <sub>P</sub> = 0 A	–	0.33	–	V
<b>Accuracy Performance</b>						
Total Output Error <sup>2</sup>	E <sub>TOT</sub>	I <sub>P</sub> = I <sub>PR(max)</sub> , T <sub>j</sub> = -40°C to 150°C	-3		3	%
<b>Total Output Error Components<sup>3</sup> E<sub>TOT</sub> = E<sub>SENS</sub> + 100 × V<sub>OE</sub>/(Sens × I<sub>P</sub>)</b>						
Sensitivity Error	E <sub>sens</sub>	I <sub>P</sub> = I <sub>PR(max)</sub> , T <sub>j</sub> = -40°C to 150°C	-2.5		2.5	%
Offset Voltage	V <sub>OE</sub>	I <sub>P</sub> = 0 A, T <sub>j</sub> = -40°C to 150°C	-10	±6	10	mV
<b>Lifetime Drift Characteristics</b>						
Sensitivity Error Lifetime Drift	E <sub>sens_drift</sub>			±1		%
Total Output Error Lifetime Drift	E <sub>tot_drift</sub>			±1		%

<sup>1</sup> Typical values with +/- are 3 sigma values

<sup>2</sup> Percentage of I<sub>P</sub>, with I<sub>P</sub> = I<sub>PR(max)</sub>.

<sup>3</sup> A single part will not have both the maximum/minimum sensitivity error and maximum/minimum offset voltage, as that would violate the maximum/minimum total output error specification. Also, 3 sigma distribution values are combined by taking the square root of the sum of the squares. See Application Information section.



	<b>Cosemitech</b>	<b>CH703</b>
	<b>Automotive Product Group</b>	This is advanced information on a new product now in development or undergoing evaluation. Details are subject to change without notice and Cosemitech assumes no obligation for future manufacture of this product. Contact Cosemitech for the latest status.

**Preliminary datasheet REV 0.6**

**CH70350CB5\* Performance Characteristics: T<sub>A</sub> Range L, valid at T<sub>j</sub> = -40°C to 150°C, unless otherwise specified**

Characteristic	Symbol	Test Conditions	Min.	Typ. <sup>1</sup>	Max.	Unit
<b>Nominal Performance</b>						
Supply Voltage	V <sub>CC</sub>		4.5	–	5.5	V
Current-Sensing Range	I <sub>PR</sub>		-50	–	50	A
Sensitivity	Sens	I <sub>PR(min)</sub> < I <sub>P</sub> < I <sub>PR(max)</sub>	–	26	–	mV/A
Zero-Current Output Voltage	V <sub>IOUT(Q)</sub>	Bidirectional, I <sub>P</sub> = 0 A	–	1.65	–	V
<b>Accuracy Performance</b>						
Total Output Error <sup>2</sup>	E <sub>TOT</sub>	I <sub>P</sub> = I <sub>PR(max)</sub> , T <sub>j</sub> = -40°C to 150°C	-3		3	%
<b>Total Output Error Components<sup>3</sup> E<sub>TOT</sub> = E<sub>SENS</sub> + 100 × V<sub>OE</sub>/(Sens × I<sub>P</sub>)</b>						
Sensitivity Error	E <sub>sens</sub>	I <sub>P</sub> = I <sub>PR(max)</sub> , T <sub>j</sub> = -40°C to 150°C	-2.5		2.5	%
Offset Voltage	V <sub>OE</sub>	I <sub>P</sub> = 0 A, T <sub>j</sub> = -40°C to 150°C	-10	±5	10	mV
<b>Lifetime Drift Characteristics</b>						
Sensitivity Error Lifetime Drift	E <sub>sens_drift</sub>			±1		%
Total Output Error Lifetime Drift	E <sub>tot_drift</sub>			±1		%

<sup>1</sup> Typical values with +/- are 3 sigma values

<sup>2</sup> Percentage of I<sub>P</sub>, with I<sub>P</sub> = I<sub>PR(max)</sub>.

<sup>3</sup> A single part will not have both the maximum/minimum sensitivity error and maximum/minimum offset voltage, as that would violate the maximum/minimum total output error specification. Also, 3 sigma distribution values are combined by taking the square root of the sum of the squares. See Application Information section.

	<b>Cosemitech</b>	<b>CH703</b>
	<b>Automotive Product Group</b>	This is advanced information on a new product now in development or undergoing evaluation. Details are subject to change without notice and Cosemitech assumes no obligation for future manufacture of this product. Contact Cosemitech for the latest status.

**Preliminary datasheet REV 0.6**

**CH70350CB3\* Performance Characteristics: T<sub>A</sub> Range L, valid at T<sub>j</sub> = -40°C to 150°C, unless otherwise specified**

Characteristic	Symbol	Test Conditions	Min.	Typ. <sup>1</sup>	Max.	Unit
<b>Nominal Performance</b>						
Supply Voltage	V <sub>CC</sub>		3	–	3.6	V
Current-Sensing Range	I <sub>PR</sub>		-50	–	50	A
Sensitivity	Sens	I <sub>PR(min)</sub> < I <sub>P</sub> < I <sub>PR(max)</sub>	–	26	–	mV/A
Zero-Current Output Voltage	V <sub>IOUT(Q)</sub>	Bidirectional, I <sub>P</sub> = 0 A	–	1.65	–	V
<b>Accuracy Performance</b>						
Total Output Error <sup>2</sup>	E <sub>TOT</sub>	I <sub>P</sub> = I <sub>PR(max)</sub> , T <sub>j</sub> = -40°C to 150°C	-3		3	%
<b>Total Output Error Components<sup>3</sup> E<sub>TOT</sub> = E<sub>SENS</sub> + 100 × V<sub>OE</sub>/(Sens × I<sub>P</sub>)</b>						
Sensitivity Error	E <sub>sens</sub>	I <sub>P</sub> = I <sub>PR(max)</sub> , T <sub>j</sub> = -40°C to 150°C	-2.5		2.5	%
Offset Voltage	V <sub>OE</sub>	I <sub>P</sub> = 0 A, T <sub>j</sub> = -40°C to 150°C	-10	±5	10	mV
<b>Lifetime Drift Characteristics</b>						
Sensitivity Error Lifetime Drift	E <sub>sens_drift</sub>			±1		%
Total Output Error Lifetime Drift	E <sub>tot_drift</sub>			±1		%

<sup>1</sup> Typical values with +/- are 3 sigma values

<sup>2</sup> Percentage of I<sub>P</sub>, with I<sub>P</sub> = I<sub>PR(max)</sub>.

<sup>3</sup> A single part will not have both the maximum/minimum sensitivity error and maximum/minimum offset voltage, as that would violate the maximum/minimum total output error specification. Also, 3 sigma distribution values are combined by taking the square root of the sum of the squares. See Application Information section.

	<b>Cosemitech</b>	<b>CH703</b>
	<b>Automotive Product Group</b>	This is advanced information on a new product now in development or undergoing evaluation. Details are subject to change without notice and Cosemitech assumes no obligation for future manufacture of this product. Contact Cosemitech for the latest status.

**Preliminary datasheet REV 0.6**

**CH70360AU5\* Performance Characteristics: T<sub>A</sub> Range L, valid at T<sub>A</sub> = -40°C to 150°C, unless otherwise specified**

Characteristic	Symbol	Test Conditions	Min.	Typ. <sup>1</sup>	Max.	Unit
<b>Nominal Performance</b>						
Supply Voltage	V <sub>CC</sub>		4.5	–	5.5	V
Current-Sensing Range	I <sub>PR</sub>		0	–	60	A
Sensitivity	Sens	I <sub>PR(min)</sub> < I <sub>P</sub> < I <sub>PR(max)</sub> , VCC = 5V	–	66	–	mV/A
Zero-Current Output Voltage	V <sub>IOUT(Q)</sub>	Unidirectional, I <sub>P</sub> = 0 A, VCC = 3.3V	–	V <sub>CC</sub> × 0.1	–	V
<b>Accuracy Performance</b>						
Total Output Error <sup>2</sup>	E <sub>TOT</sub>	I <sub>P</sub> = I <sub>PR(max)</sub> , T <sub>A</sub> = -40°C to 150°C	-3		3	%
<b>Total Output Error Components<sup>3</sup> E<sub>TOT</sub> = E<sub>SENS</sub> + 100 × V<sub>OE</sub>/(Sens × I<sub>P</sub>)</b>						
Sensitivity Error	E <sub>sens</sub>	I <sub>P</sub> = I <sub>PR(max)</sub> , T <sub>A</sub> = -40°C to 150°C	-2.5		2.5	%
Offset Voltage	V <sub>OE</sub>	I <sub>P</sub> = 0 A, T <sub>A</sub> = -40°C to 150°C	-10	±6	10	mV
<b>Lifetime Drift Characteristics</b>						
Sensitivity Error Lifetime Drift	E <sub>sens_drift</sub>		-3	±1	3	%
Total Output Error Lifetime Drift	E <sub>tot_drift</sub>		-3	±1	3	%

<sup>1</sup> Typical values with +/- are 3 sigma values

<sup>2</sup> Percentage of I<sub>P</sub>, with I<sub>P</sub> = I<sub>PR(max)</sub>.

<sup>3</sup> A single part will not have both the maximum/minimum sensitivity error and maximum/minimum offset voltage, as that would violate the maximum/minimum total output error specification. Also, 3 sigma distribution values are combined by taking the square root of the sum of the squares. See Application Information section.

	<b>Cosemitech</b>	<b>CH703</b>
	<b>Automotive Product Group</b>	This is advanced information on a new product now in development or undergoing evaluation. Details are subject to change without notice and Cosemitech assumes no obligation for future manufacture of this product. Contact Cosemitech for the latest status.

**Preliminary datasheet REV 0.6**

**CH70360AU3\* Performance Characteristics: T<sub>A</sub> Range L, valid at T<sub>A</sub> = -40°C to 150°C, unless otherwise specified**

Characteristic	Symbol	Test Conditions	Min.	Typ. <sup>1</sup>	Max.	Unit
<b>Nominal Performance</b>						
Supply Voltage	V <sub>CC</sub>		3	–	3.6	V
Current-Sensing Range	I <sub>PR</sub>		0	–	60	A
Sensitivity	Sens	I <sub>PR(min)</sub> < I <sub>P</sub> < I <sub>PR(max)</sub> , V <sub>CC</sub> = 3.3V	–	44	–	mV/A
Zero-Current Output Voltage	V <sub>IOUT(Q)</sub>	Unidirectional, I <sub>P</sub> = 0 A, V <sub>CC</sub> = 3.3V	–	V <sub>CC</sub> × 0.1	–	V
<b>Accuracy Performance</b>						
Total Output Error <sup>2</sup>	E <sub>TOT</sub>	I <sub>P</sub> = I <sub>PR(max)</sub> , T <sub>A</sub> = -40°C to 150°C	-3		3	%
<b>Total Output Error Components<sup>3</sup> E<sub>TOT</sub> = E<sub>SENS</sub> + 100 × V<sub>OE</sub>/(Sens × I<sub>P</sub>)</b>						
Sensitivity Error	E <sub>sens</sub>	I <sub>P</sub> = I <sub>PR(max)</sub> , T <sub>A</sub> = -40°C to 150°C	-2.5		2.5	%
Offset Voltage	V <sub>OE</sub>	I <sub>P</sub> = 0 A, T <sub>A</sub> = -40°C to 150°C	-10	±6	10	mV
<b>Lifetime Drift Characteristics</b>						
Sensitivity Error Lifetime Drift	E <sub>sens_drift</sub>		-3	±1	3	%
Total Output Error Lifetime Drift	E <sub>tot_drift</sub>		-3	±1	3	%

<sup>1</sup> Typical values with +/- are 3 sigma values

<sup>2</sup> Percentage of I<sub>P</sub>, with I<sub>P</sub> = I<sub>PR(max)</sub>.

<sup>3</sup> A single part will not have both the maximum/minimum sensitivity error and maximum/minimum offset voltage, as that would violate the maximum/minimum total output error specification. Also, 3 sigma distribution values are combined by taking the square root of the sum of the squares. See Application Information section.

	<b>Cosemitech</b>	<b>CH703</b>
	<b>Automotive Product Group</b>	This is advanced information on a new product now in development or undergoing evaluation. Details are subject to change without notice and Cosemitech assumes no obligation for future manufacture of this product. Contact Cosemitech for the latest status.

**Preliminary datasheet REV 0.6**

**CH70360AB5\* Performance Characteristics: T<sub>A</sub> Range L, valid at T<sub>A</sub> = -40°C to 150°C, unless otherwise specified**

Characteristic	Symbol	Test Conditions	Min.	Typ. <sup>1</sup>	Max.	Unit
<b>Nominal Performance</b>						
Supply Voltage	V <sub>CC</sub>		4.5	–	5.5	V
Current-Sensing Range	I <sub>PR</sub>		-60	–	60	A
Sensitivity	Sens	I <sub>PR(min)</sub> < I <sub>P</sub> < I <sub>PR(max)</sub> , V <sub>CC</sub> = 5V	–	33	–	mV/A
Zero-Current Output Voltage	V <sub>IOUT(Q)</sub>	Bidirectional, I <sub>P</sub> = 0 A, V <sub>CC</sub> = 5V	–	V <sub>CC</sub> × 0.5	–	V
<b>Accuracy Performance</b>						
Total Output Error <sup>2</sup>	E <sub>TOT</sub>	I <sub>P</sub> = I <sub>PR(max)</sub> , T <sub>A</sub> = -40°C to 150°C	-3		3	%
<b>Total Output Error Components<sup>3</sup> E<sub>TOT</sub> = E<sub>SENS</sub> + 100 × V<sub>OE</sub>/(Sens × I<sub>P</sub>)</b>						
Sensitivity Error	E <sub>sens</sub>	I <sub>P</sub> = I <sub>PR(max)</sub> , T <sub>A</sub> = -40°C to 150°C	-2.5		2.5	%
Offset Voltage	V <sub>OE</sub>	I <sub>P</sub> = 0 A, T <sub>A</sub> = -40°C to 150°C	-10	±5	10	mV
<b>Lifetime Drift Characteristics</b>						
Sensitivity Error Lifetime Drift	E <sub>sens_drift</sub>		-3	±1	3	%
Total Output Error Lifetime Drift	E <sub>tot_drift</sub>		-3	±1	3	%

<sup>1</sup> Typical values with +/- are 3 sigma values

<sup>2</sup> Percentage of I<sub>P</sub>, with I<sub>P</sub> = I<sub>PR(max)</sub>.

<sup>3</sup> A single part will not have both the maximum/minimum sensitivity error and maximum/minimum offset voltage, as that would violate the maximum/minimum total output error specification. Also, 3 sigma distribution values are combined by taking the square root of the sum of the squares. See Application Information section.

	<b>Cosemitech</b>	<b>CH703</b>
	<b>Automotive Product Group</b>	This is advanced information on a new product now in development or undergoing evaluation. Details are subject to change without notice and Cosemitech assumes no obligation for future manufacture of this product. Contact Cosemitech for the latest status.

**Preliminary datasheet REV 0.6**

**CH70360AB3\* Performance Characteristics: T<sub>A</sub> Range L, valid at T<sub>A</sub> = -40°C to 150°C, unless otherwise specified**

Characteristic	Symbol	Test Conditions	Min.	Typ. <sup>1</sup>	Max.	Unit
<b>Nominal Performance</b>						
Supply Voltage	V <sub>CC</sub>		3	–	3.6	V
Current-Sensing Range	I <sub>PR</sub>		-60	–	60	A
Sensitivity	Sens	I <sub>PR(min)</sub> < I <sub>P</sub> < I <sub>PR(max)</sub> , VCC = 3.3V	–	22	–	mV/A
Zero-Current Output Voltage	V <sub>IOUT(Q)</sub>	Bidirectional, I <sub>P</sub> = 0 A, VCC = 3.3V	–	V <sub>CC</sub> × 0.5	–	V
<b>Accuracy Performance</b>						
Total Output Error <sup>2</sup>	E <sub>TOT</sub>	I <sub>P</sub> = I <sub>PR(max)</sub> , T <sub>A</sub> = -40°C to 150°C	-3		3	%
<b>Total Output Error Components<sup>3</sup> E<sub>TOT</sub> = E<sub>SENS</sub> + 100 × V<sub>OE</sub>/(Sens × I<sub>P</sub>)</b>						
Sensitivity Error	E <sub>sens</sub>	I <sub>P</sub> = I <sub>PR(max)</sub> , T <sub>A</sub> = -40°C to 150°C	-2.5		2.5	%
Offset Voltage	V <sub>OE</sub>	I <sub>P</sub> = 0 A, T <sub>A</sub> = -40°C to 150°C	-10	±5	10	mV
<b>Lifetime Drift Characteristics</b>						
Sensitivity Error Lifetime Drift	E <sub>sens_drift</sub>		-3	±1	3	%
Total Output Error Lifetime Drift	E <sub>tot_drift</sub>		-3	±1	3	%

<sup>1</sup> Typical values with +/- are 3 sigma values

<sup>2</sup> Percentage of I<sub>P</sub>, with I<sub>P</sub> = I<sub>PR(max)</sub>.

<sup>3</sup> A single part will not have both the maximum/minimum sensitivity error and maximum/minimum offset voltage, as that would violate the maximum/minimum total output error specification. Also, 3 sigma distribution values are combined by taking the square root of the sum of the squares. See Application Information section.

	<b>Cosemitech</b>	<b>CH703</b>
	<b>Automotive Product Group</b>	This is advanced information on a new product now in development or undergoing evaluation. Details are subject to change without notice and Cosemitech assumes no obligation for future manufacture of this product. Contact Cosemitech for the latest status.

**Preliminary datasheet REV 0.6**

**CH70360BU5\* Performance Characteristics: T<sub>A</sub> Range L, valid at T<sub>A</sub> = -40°C to 150°C, unless otherwise specified**

Characteristic	Symbol	Test Conditions	Min.	Typ. <sup>1</sup>	Max.	Unit
<b>Nominal Performance</b>						
Supply Voltage	V <sub>CC</sub>		4.5	–	5.5	V
Current-Sensing Range	I <sub>PR</sub>		0	–	60	A
Sensitivity	Sens	I <sub>PR(min)</sub> < I <sub>P</sub> < I <sub>PR(max)</sub>	–	66	–	mV/A
Zero-Current Output Voltage	V <sub>IOUT(Q)</sub>	Unidirectional, I <sub>P</sub> = 0 A	–	0.5	–	V
<b>Accuracy Performance</b>						
Total Output Error <sup>2</sup>	E <sub>TOT</sub>	I <sub>P</sub> = I <sub>PR(max)</sub> , T <sub>A</sub> = -40°C to 150°C	-3		3	%
<b>Total Output Error Components<sup>3</sup> E<sub>TOT</sub> = E<sub>SENS</sub> + 100 × V<sub>OE</sub>/(Sens × I<sub>P</sub>)</b>						
Sensitivity Error	E <sub>sens</sub>	I <sub>P</sub> = I <sub>PR(max)</sub> , T <sub>A</sub> = -40°C to 150°C	-2.5		2.5	%
Offset Voltage	V <sub>OE</sub>	I <sub>P</sub> = 0 A, T <sub>A</sub> = -40°C to 150°C	-10	±6	10	mV
<b>Lifetime Drift Characteristics</b>						
Sensitivity Error Lifetime Drift	E <sub>sens_drift</sub>		-3	±1	3	%
Total Output Error Lifetime Drift	E <sub>tot_drift</sub>		-3	±1	3	%

<sup>1</sup> Typical values with +/- are 3 sigma values

<sup>2</sup> Percentage of I<sub>P</sub>, with I<sub>P</sub> = I<sub>PR(max)</sub>.

<sup>3</sup> A single part will not have both the maximum/minimum sensitivity error and maximum/minimum offset voltage, as that would violate the maximum/minimum total output error specification. Also, 3 sigma distribution values are combined by taking the square root of the sum of the squares. See Application Information section.

	<b>Cosemitech</b>	<b>CH703</b>
	<b>Automotive Product Group</b>	This is advanced information on a new product now in development or undergoing evaluation. Details are subject to change without notice and Cosemitech assumes no obligation for future manufacture of this product. Contact Cosemitech for the latest status.

**Preliminary datasheet REV 0.6**

**CH70360BB5\* Performance Characteristics: T<sub>A</sub> Range L, valid at T<sub>A</sub> = -40°C to 150°C, unless otherwise specified**

Characteristic	Symbol	Test Conditions	Min.	Typ. <sup>1</sup>	Max.	Unit
<b>Nominal Performance</b>						
Supply Voltage	V <sub>CC</sub>		4.5	–	5.5	V
Current-Sensing Range	I <sub>PR</sub>		-60	–	60	A
Sensitivity	Sens	I <sub>PR(min)</sub> < I <sub>P</sub> < I <sub>PR(max)</sub>	–	33	–	mV/A
Zero-Current Output Voltage	V <sub>IOUT(Q)</sub>	Bidirectional, I <sub>P</sub> = 0 A	–	2.5	–	V
<b>Accuracy Performance</b>						
Total Output Error <sup>2</sup>	E <sub>TOT</sub>	I <sub>P</sub> = I <sub>PR(max)</sub> , T <sub>A</sub> = -40°C to 150°C	-3		3	%
<b>Total Output Error Components<sup>3</sup> E<sub>TOT</sub> = E<sub>SENS</sub> + 100 × V<sub>OE</sub>/(Sens × I<sub>P</sub>)</b>						
Sensitivity Error	E <sub>sens</sub>	I <sub>P</sub> = I <sub>PR(max)</sub> , T <sub>A</sub> = -40°C to 150°C	-2.5		2.5	%
Offset Voltage	V <sub>OE</sub>	I <sub>P</sub> = 0 A, T <sub>A</sub> = -40°C to 150°C	-10	±5	10	mV
<b>Lifetime Drift Characteristics</b>						
Sensitivity Error Lifetime Drift	E <sub>sens_drift</sub>		-3	±1	3	%
Total Output Error Lifetime Drift	E <sub>tot_drift</sub>		-3	±1	3	%

<sup>1</sup> Typical values with +/- are 3 sigma values

<sup>2</sup> Percentage of I<sub>P</sub>, with I<sub>P</sub> = I<sub>PR(max)</sub>.

<sup>3</sup> A single part will not have both the maximum/minimum sensitivity error and maximum/minimum offset voltage, as that would violate the maximum/minimum total output error specification. Also, 3 sigma distribution values are combined by taking the square root of the sum of the squares. See Application Information section.



	<b>Cosemitech</b>	<b>CH703</b>
	<b>Automotive Product Group</b>	This is advanced information on a new product now in development or undergoing evaluation. Details are subject to change without notice and Cosemitech assumes no obligation for future manufacture of this product. Contact Cosemitech for the latest status.

**Preliminary datasheet REV 0.6**

**CH70360CU5\* Performance Characteristics: T<sub>A</sub> Range L, valid at T<sub>A</sub> = -40°C to 150°C, unless otherwise specified**

Characteristic	Symbol	Test Conditions	Min.	Typ. <sup>1</sup>	Max.	Unit
<b>Nominal Performance</b>						
Supply Voltage	V <sub>CC</sub>		4.5	–	5.5	V
Current-Sensing Range	I <sub>PR</sub>		0	–	60	A
Sensitivity	Sens	I <sub>PR(min)</sub> < I <sub>P</sub> < I <sub>PR(max)</sub>	–	44	–	mV/A
Zero-Current Output Voltage	V <sub>IOUT(Q)</sub>	Unidirectional, I <sub>P</sub> = 0 A	–	0.33	–	V
<b>Accuracy Performance</b>						
Total Output Error <sup>2</sup>	E <sub>TOT</sub>	I <sub>P</sub> = I <sub>PR(max)</sub> , T <sub>A</sub> = -40°C to 150°C	-3		3	%
<b>Total Output Error Components<sup>3</sup> E<sub>TOT</sub> = E<sub>SENS</sub> + 100 × V<sub>OE</sub>/(Sens × I<sub>P</sub>)</b>						
Sensitivity Error	E <sub>sens</sub>	I <sub>P</sub> = I <sub>PR(max)</sub> , T <sub>A</sub> = -40°C to 150°C	-2.5		2.5	%
Offset Voltage	V <sub>OE</sub>	I <sub>P</sub> = 0 A, T <sub>A</sub> = -40°C to 150°C	-10	±6	10	mV
<b>Lifetime Drift Characteristics</b>						
Sensitivity Error Lifetime Drift	E <sub>sens_drift</sub>		-3	±1	3	%
Total Output Error Lifetime Drift	E <sub>tot_drift</sub>		-3	±1	3	%

<sup>1</sup> Typical values with +/- are 3 sigma values

<sup>2</sup> Percentage of I<sub>P</sub>, with I<sub>P</sub> = I<sub>PR(max)</sub>.

<sup>3</sup> A single part will not have both the maximum/minimum sensitivity error and maximum/minimum offset voltage, as that would violate the maximum/minimum total output error specification. Also, 3 sigma distribution values are combined by taking the square root of the sum of the squares. See Application Information section.

	<b>Cosemitech</b>	<b>CH703</b>
	<b>Automotive Product Group</b>	This is advanced information on a new product now in development or undergoing evaluation. Details are subject to change without notice and Cosemitech assumes no obligation for future manufacture of this product. Contact Cosemitech for the latest status.

**Preliminary datasheet REV 0.6**

**CH70360CU3\* Performance Characteristics: T<sub>A</sub> Range L, valid at T<sub>A</sub> = -40°C to 150°C, unless otherwise specified**

Characteristic	Symbol	Test Conditions	Min.	Typ. <sup>1</sup>	Max.	Unit
<b>Nominal Performance</b>						
Supply Voltage	V <sub>CC</sub>		3	–	3.6	V
Current-Sensing Range	I <sub>PR</sub>		0	–	60	A
Sensitivity	Sens	I <sub>PR(min)</sub> < I <sub>P</sub> < I <sub>PR(max)</sub>	–	44	–	mV/A
Zero-Current Output Voltage	V <sub>IOUT(Q)</sub>	Unidirectional, I <sub>P</sub> = 0 A	–	0.33	–	V
<b>Accuracy Performance</b>						
Total Output Error <sup>2</sup>	E <sub>TOT</sub>	I <sub>P</sub> = I <sub>PR(max)</sub> , T <sub>A</sub> = -40°C to 150°C	-3		3	%
<b>Total Output Error Components<sup>3</sup> E<sub>TOT</sub> = E<sub>SENS</sub> + 100 × V<sub>OE</sub>/(Sens × I<sub>P</sub>)</b>						
Sensitivity Error	E <sub>sens</sub>	I <sub>P</sub> = I <sub>PR(max)</sub> , T <sub>A</sub> = -40°C to 150°C	-2.5		2.5	%
Offset Voltage	V <sub>OE</sub>	I <sub>P</sub> = 0 A, T <sub>A</sub> = -40°C to 150°C	-10	±6	10	mV
<b>Lifetime Drift Characteristics</b>						
Sensitivity Error Lifetime Drift	E <sub>sens_drift</sub>		-3	±1	3	%
Total Output Error Lifetime Drift	E <sub>tot_drift</sub>		-3	±1	3	%

<sup>1</sup> Typical values with +/- are 3 sigma values

<sup>2</sup> Percentage of I<sub>P</sub>, with I<sub>P</sub> = I<sub>PR(max)</sub>.

<sup>3</sup> A single part will not have both the maximum/minimum sensitivity error and maximum/minimum offset voltage, as that would violate the maximum/minimum total output error specification. Also, 3 sigma distribution values are combined by taking the square root of the sum of the squares. See Application Information section.

	<b>Cosemitech</b>	<b>CH703</b>
	<b>Automotive Product Group</b>	This is advanced information on a new product now in development or undergoing evaluation. Details are subject to change without notice and Cosemitech assumes no obligation for future manufacture of this product. Contact Cosemitech for the latest status.

**Preliminary datasheet REV 0.6**

**CH70360CB5\* Performance Characteristics: T<sub>A</sub> Range L, valid at T<sub>A</sub> = -40°C to 150°C, unless otherwise specified**

Characteristic	Symbol	Test Conditions	Min.	Typ. <sup>1</sup>	Max.	Unit
<b>Nominal Performance</b>						
Supply Voltage	V <sub>CC</sub>		4.5	–	5.5	V
Current-Sensing Range	I <sub>PR</sub>		-60	–	60	A
Sensitivity	Sens	I <sub>PR(min)</sub> < I <sub>P</sub> < I <sub>PR(max)</sub>	–	22	–	mV/A
Zero-Current Output Voltage	V <sub>IOUT(Q)</sub>	Bidirectional, I <sub>P</sub> = 0 A	–	1.65	–	V
<b>Accuracy Performance</b>						
Total Output Error <sup>2</sup>	E <sub>TOT</sub>	I <sub>P</sub> = I <sub>PR(max)</sub> , T <sub>A</sub> = -40°C to 150°C	-3		3	%
<b>Total Output Error Components<sup>3</sup> E<sub>TOT</sub> = E<sub>SENS</sub> + 100 × V<sub>OE</sub>/(Sens × I<sub>P</sub>)</b>						
Sensitivity Error	E <sub>sens</sub>	I <sub>P</sub> = I <sub>PR(max)</sub> , T <sub>A</sub> = -40°C to 150°C	-2.5		2.5	%
Offset Voltage	V <sub>OE</sub>	I <sub>P</sub> = 0 A, T <sub>A</sub> = -40°C to 150°C	-10	±5	10	mV
<b>Lifetime Drift Characteristics</b>						
Sensitivity Error Lifetime Drift	E <sub>sens_drift</sub>		-3	±1	3	%
Total Output Error Lifetime Drift	E <sub>tot_drift</sub>		-3	±1	3	%

<sup>1</sup> Typical values with +/- are 3 sigma values

<sup>2</sup> Percentage of I<sub>P</sub>, with I<sub>P</sub> = I<sub>PR(max)</sub>.

<sup>3</sup> A single part will not have both the maximum/minimum sensitivity error and maximum/minimum offset voltage, as that would violate the maximum/minimum total output error specification. Also, 3 sigma distribution values are combined by taking the square root of the sum of the squares. See Application Information section.

	<b>Cosemitech</b>	<b>CH703</b>
	<b>Automotive Product Group</b>	This is advanced information on a new product now in development or undergoing evaluation. Details are subject to change without notice and Cosemitech assumes no obligation for future manufacture of this product. Contact Cosemitech for the latest status.

**Preliminary datasheet REV 0.6**

**CH70360CB3\* Performance Characteristics: T<sub>A</sub> Range L, valid at T<sub>A</sub> = -40°C to 150°C, unless otherwise specified**

Characteristic	Symbol	Test Conditions	Min.	Typ. <sup>1</sup>	Max.	Unit
<b>Nominal Performance</b>						
Supply Voltage	V <sub>CC</sub>		3	–	3.6	V
Current-Sensing Range	I <sub>PR</sub>		-60	–	60	A
Sensitivity	Sens	I <sub>PR(min)</sub> < I <sub>P</sub> < I <sub>PR(max)</sub>	–	22	–	mV/A
Zero-Current Output Voltage	V <sub>IOUT(Q)</sub>	Bidirectional, I <sub>P</sub> = 0 A	–	1.65	–	V
<b>Accuracy Performance</b>						
Total Output Error <sup>2</sup>	E <sub>TOT</sub>	I <sub>P</sub> = I <sub>PR(max)</sub> , T <sub>A</sub> = -40°C to 150°C	-3		3	%
<b>Total Output Error Components<sup>3</sup> E<sub>TOT</sub> = E<sub>SENS</sub> + 100 × V<sub>OE</sub>/(Sens × I<sub>P</sub>)</b>						
Sensitivity Error	E <sub>sens</sub>	I <sub>P</sub> = I <sub>PR(max)</sub> , T <sub>A</sub> = -40°C to 150°C	-2.5		2.5	%
Offset Voltage	V <sub>OE</sub>	I <sub>P</sub> = 0 A, T <sub>A</sub> = -40°C to 150°C	-10	±5	10	mV
<b>Lifetime Drift Characteristics</b>						
Sensitivity Error Lifetime Drift	E <sub>sens_drift</sub>		-3	±1	3	%
Total Output Error Lifetime Drift	E <sub>tot_drift</sub>		-3	±1	3	%

<sup>1</sup> Typical values with +/- are 3 sigma values

<sup>2</sup> Percentage of I<sub>P</sub>, with I<sub>P</sub> = I<sub>PR(max)</sub>.

<sup>3</sup> A single part will not have both the maximum/minimum sensitivity error and maximum/minimum offset voltage, as that would violate the maximum/minimum total output error specification. Also, 3 sigma distribution values are combined by taking the square root of the sum of the squares. See Application Information section.

	<b>Cosemitech</b>	<b>CH703</b>
	<b>Automotive Product Group</b>	<small>This is advanced information on a new product now in development or undergoing evaluation. Details are subject to change without notice and Cosemitech assumes no obligation for future manufacture of this product. Contact Cosemitech for the latest status.</small>

**Preliminary datasheet REV 0.6**

## 6 Function Description

### 6.1 General Function

The CH703 is programmable Hall-Effect Linear current sensor. The current flowing through the primary side current path induces a corresponding magnetic field measured by a built-in Hall plate. The magnetic flux through the Hall plate is proportional to the primary current. And the output signal amplified and filtered from Hall voltage induced is proportional the sensed current. The output signal also can be proportional to the supply voltage (ratio-metric behavior) as long as the analog output mode is selected.

The sensitivity and offset can be adjusted by programming the EEPROM registers. And the temperature characteristics of sensitivity and offset of Hall plate will be compensated by the coefficients stored in the EEPROM memory. Then the output voltage signal will have a good linear and temperature characteristic with the sensed current.

Futuremore the several parameters like Unidirectional/Bidirectional current, output voltage range and input voltage range, Application Information

## 7 Application Information

### 7.1 Estimating Total Error vs. Sensed Current

The Performance Characteristics tables give distribution ( $\pm 3\sigma$ ) values for Total Error at  $I_{PR(max)}$ ; however, one often wants to know what error to expect at a particular current. This can be estimated by using the distribution data for the components of Total Error, Sensitivity Error, and Offset Voltage. The  $\pm 3$  sigma value for Total Error ( $E_{TOT}$ ) as a function of the sensed current ( $I_P$ ) is estimated as:

$$E_{TOT}(I_P) = \sqrt{E_{SENS}^2 + \left(\frac{100 \times V_{OE}}{Sens \times I_P}\right)^2}$$

Here,  $E_{SENS}$  and  $V_{OE}$  are the  $\pm 3$  sigma values for those error terms. If there is an average sensitivity error or average offset voltage, then the average Total Error is estimated as:

$$E_{TOT\_AVG}(I_P) = E_{SENS\_AVG} + \frac{100 \times V_{OE\_AVG}}{Sens \times I_P}$$

The resulting total error will be a sum of  $E_{TOT}$  and  $E_{TOT\_AVG}$ . Using these equations and the 3 sigma distributions for Sensitivity Error and Offset Voltage, the Total Error versus sensed current ( $I_P$ ) is below for the CH70320AB. As expected, as one goes towards zero current, the error in percent goes towards infinity due to division by zero.

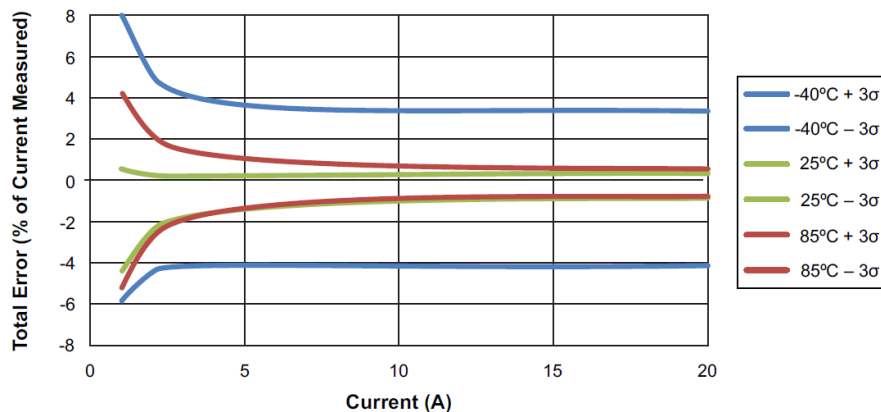

Figure 1: Predicted Total Error as a Function of the Sensed Current for the CH70320AB

## 7.2 Definitions of accuracy characteristics

**Sensitivity (Sens).** The change in sensor IC output in response to a 1 A change through the primary conductor. The sensitivity is the product of the magnetic circuit sensitivity (G/A) (1 G = 0.1 mT) and the linear IC amplifier gain (mV/G). The linear IC amplifier gain is programmed at the factory to optimize the sensitivity (mV/A) for the full-scale current of the device.

**Nonlinearity (E<sub>LIN</sub>).** The nonlinearity is a measure of how linear the output of the sensor IC is over the full current measurement range. The nonlinearity is calculated as:

$$E_{LIN} = \left\{ 1 - \left[ \frac{V_{IOUT}(I_{PR(max)}) - V_{IOUT(Q)}}{2 \times V_{IOUT}(I_{PR(max)}/2) - V_{IOUT(Q)}} \right] \right\} \times 100(\%)$$

where  $V_{IOUT}(I_{PR(max)})$  is the output of the sensor IC with the maximum measurement current flowing through it and  $V_{IOUT}(I_{PR(max)}/2)$  is the output of the sensor IC with half of the maximum measurement current flowing through it.

**Zero-Current Output Voltage (V<sub>IOUT(Q)</sub>).** The output of the sensor when the primary current is zero. For a unipolar supply voltage, it nominally remains at  $0.5 \times V_{CC}$  for a bidirectional device and  $0.1 \times V_{CC}$  for a unidirectional device. For example, in the case of a bidirectional output device,  $V_{CC} = 5\text{ V}$  translates into  $V_{IOUT(Q)} = 2.5\text{ V}$ . Variation in  $V_{IOUT(Q)}$  can be attributed to the resolution of the linear IC quiescent voltage trim and thermal drift.

**Offset Voltage (V<sub>OE</sub>).** The deviation of the device output from its ideal quiescent value of  $0.5 \times V_{CC}$  (bidirectional) or  $0.1 \times V_{CC}$  (unidirectional) due to nonmagnetic causes. To convert this voltage to amperes, divide by the device sensitivity, Sens.

**Total Output Error (E<sub>TOT</sub>).** The difference between the current measurement from the sensor IC and the actual current ( $I_P$ ), relative to the actual current. This is equivalent to the difference between the ideal output voltage and the actual output voltage, divided by the ideal sensitivity, relative to the current flowing through the primary conduction path:

$$E_{TOT}(I_P) = \frac{V_{IOUT\_ideal}(I_P) - V_{IOUT}(I_P)}{Sens_{ideal}(I_P) \times I_P} \times 100(\%)$$

The Total Output Error incorporates all sources of error and is a function of  $I_P$ . At relatively high currents,  $E_{TOT}$  will be mostly due to sensitivity error, and at relatively low currents,  $E_{TOT}$  will be mostly due to Offset Voltage ( $V_{OE}$ ). In fact, at  $I_P = 0$ ,  $E_{TOT}$  approaches infinity due to the offset. This is illustrated in Figures 2 and 3. Figure 2 shows a distribution of output voltages versus  $I_P$  at 25°C and across temperature. Figure 3 shows the corresponding  $E_{TOT}$  versus  $I_P$ .

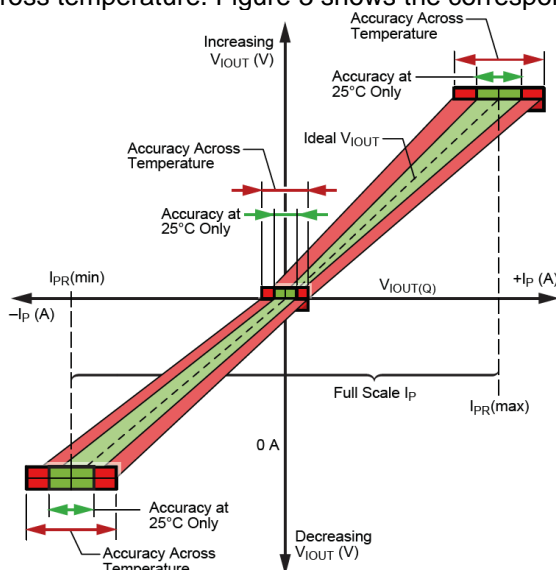

Figure 2: Output Voltage versus Sensed Current

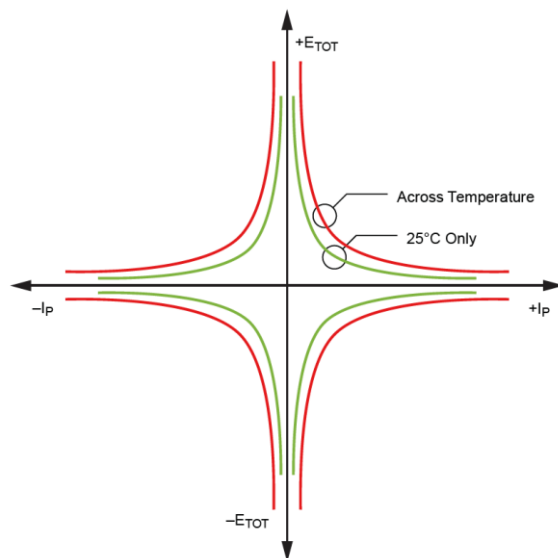

Figure 3: Total Output Error versus Sensed Current

**Sensitivity Ratiometry Coefficient (SENS\_RAT\_COEF).** The coefficient defines how the sensitivity scales with  $V_{CC}$ . The ideal coefficient is 1, meaning the sensitivity scales proportionally with  $V_{CC}$ . A 10% increase in  $V_{CC}$  results in a 10% increase in sensitivity. A coefficient of 1.1 means that the

**Preliminary datasheet REV 0.6**

sensitivity increases by 10% more than the ideal proportionality case. This means that a 10% increase in  $V_{CC}$  results in an 11% increase in sensitivity. This relationship is described by the following equation:

$$\text{Sens}(V_{CC}) = \text{Sens}(5V) \left[ 1 + \frac{(V_{CC} - 5V) \times \text{SENS\_RAT\_COEF}}{5V} \right]$$

This can be rearranged to define the sensitivity ratiometry coefficient as:

$$\text{SENS\_RAT\_COEF} = \left[ \frac{\text{Sens}(V_{CC})}{\text{Sens}(5V)} - 1 \right] \times \frac{5V}{V_{CC} - 5V}$$

**Zero-Current Output Ratiometry Coefficient (QVO\_RAT\_COEF).** The coefficient defines how the zero-current output voltage scales with  $V_{CC}$ . The ideal coefficient is 1, meaning the output voltage scales proportionally with  $V_{CC}$ , always being equal to  $V_{CC}/2$ . A coefficient of 1.1 means that the zero-current output voltage increases by 10% more than the ideal proportionality case. This means that a 10% increase in  $V_{CC}$  results in an 11% increase in the zero-current output voltage. This relationship is described by the following equation:

$$\text{VIOUTQ}(V_{CC}) = \text{VIOUTQ}(5V) \left[ 1 + \frac{(V_{CC} - 5V) \times \text{QVO\_RAT\_COEF}}{5V} \right]$$

This can be rearranged to define the zero-current output ratiometry coefficient as:

$$\text{QVO\_RAT\_COEF} = \left[ \frac{\text{VIOUTQ}(V_{CC})}{\text{VIOUTQ}(5V)} - 1 \right] \times \frac{5V}{V_{CC} - 5V}$$

### 7.3 Definitions of dynamic response characteristics

**Power-On Time ( $t_{PO}$ ).** When the supply is ramped to its operating voltage, the device requires a finite time to power its internal components before responding to an input magnetic field. Power-On Time,  $t_{PO}$ , is defined as the time it takes for the output voltage to settle within  $\pm 10\%$  of its steady-state value under an applied magnetic field, after the power supply has reached its minimum specified operating voltage,  $V_{CC(\min)}$ , as shown in the chart at right.

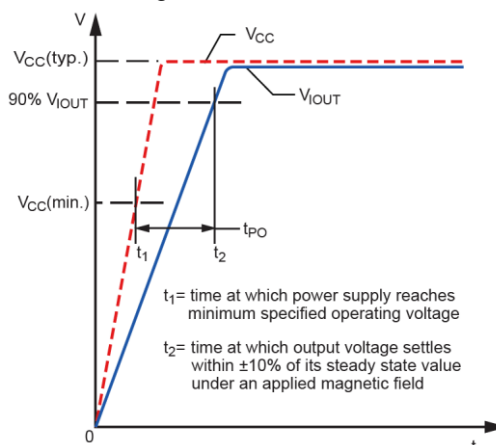

Figure 4: Power-On Time

**Rise Time ( $t_r$ ).** The time interval between a) when the sensor IC reaches 10% of its full-scale value, and b) when it reaches 90% of its full-scale value. The rise time to a step response is used to derive the bandwidth of the current sensor IC, in which  $f(-3 \text{ dB}) = 0.35 / t_r$ . Both  $t_r$  and  $t_{RESPONSE}$  are detrimentally affected by eddy-current losses observed in the conductive IC ground plane.

**Propagation Delay ( $t_{pd}$ ).** The propagation delay is measured as the time interval a) when the primary current signal reaches 20% of its final value, and b) when the device reaches 20% of its output corresponding to the applied current.

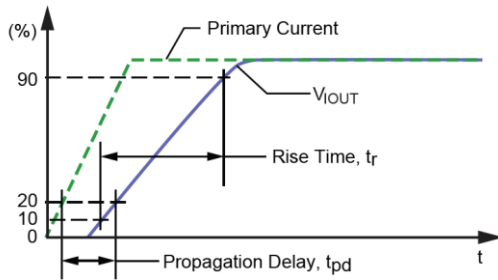

Figure 5: Rise Time and Propagation Delay

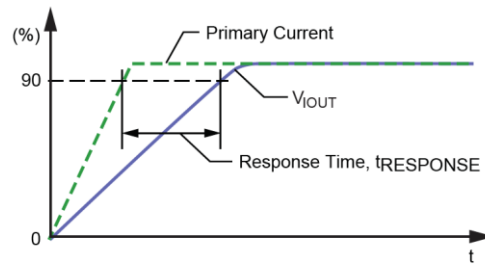

Figure 6: Response Time

**Response Time ( $t_{\text{RESPONSE}}$ ).** The time interval between a) when the primary current signal reaches 90% of its final value, and b) when the device reaches 90% of its output corresponding to the applied current.



## 8 Package Information:

**For Reference Only – Not for Tooling Use**

(Reference MS-012AA)

Dimensions in millimeters – NOT TO SCALE

Dimensions exclusive of mold flash, gate burrs, and dambar protrusions

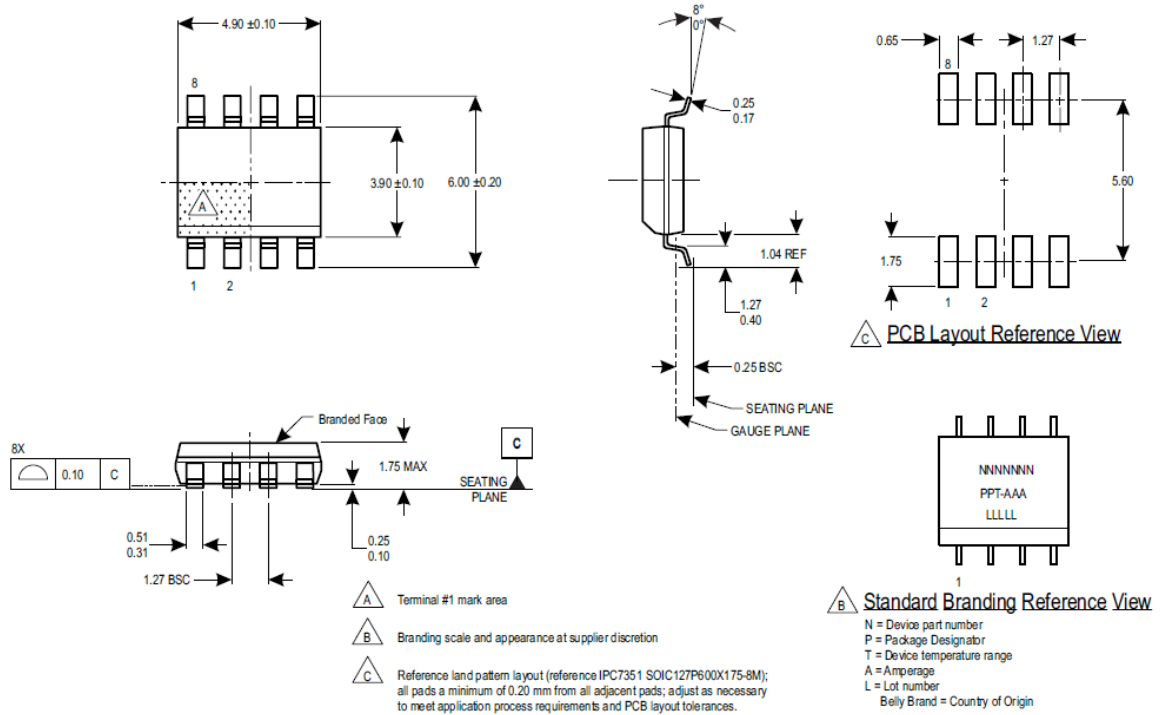



Figure 7: Package LC, 8-pin SOICN

	<b>Cosemitech</b>	<b>CH703</b>
	<b>Automotive Product Group</b>	<small>This is advanced information on a new product now in development or undergoing evaluation. Details are subject to change without notice and Cosemitech assumes no obligation for future manufacture of this product. Contact Cosemitech for the latest status.</small>

**Preliminary datasheet REV 0.6**

Information furnished is believed to be accurate and reliable. However, Cosemitech assumes no responsibility for the consequences of use of such information nor for any infringement of patents or other rights of third parties which may result from its use. No license is granted by implication or otherwise under any patent or patent rights of Cosemitech. Specification mentioned in this publication are subject to change without notice. This publication supersedes and replaces all information previously supplied. Cosemitech products are not authorized for use as critical components in life support devices or systems without express written approval of Cosemitech.

The Cosemitech logo is a registered trademark of Cosemitech

单击下面可查看定价，库存，交付和生命周期等信息

[>>cosemitech\(意瑞半导体\)](#)