



flowPHASE 1 SiC

1200 V / 16 mΩ

Features

- High frequency SiC MOSFET
- High power low inductive package
- Integrated NTC

Target applications

- Charging Stations
- Industrial Drives
- Power Supply

Types

- 10-EZ122PA016ME-LJ67F68T

flow E1 12 mm housing

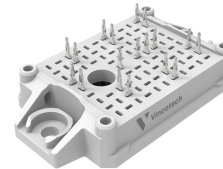

Schematic

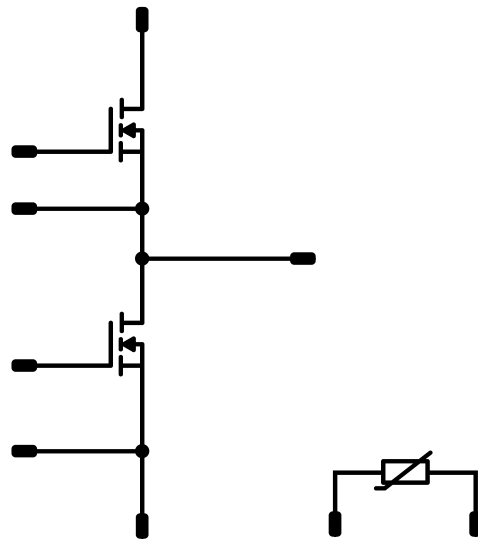



Vincotech

10-EZ122PA016ME-LJ67F68T
datasheet

Maximum Ratings

$T_j = 25\text{ °C}$, unless otherwise specified

Parameter	Symbol	Conditions	Value	Unit
Half-Bridge Switch				
Drain-source voltage	V_{DSS}		1200	V
Drain current (DC current)	I_D	$T_j = T_{jmax}$ $T_s = 80\text{ °C}$	83	A
Peak drain current	I_{DM}	t_p limited by T_{jmax}	240	A
Total power dissipation	P_{tot}	$T_j = T_{jmax}$ $T_s = 80\text{ °C}$	168	W
Gate-source voltage	V_{GSS}		-4 / 15	V
		dynamic	-8 / 19	
Maximum Junction Temperature	T_{jmax}		175	°C

Module Properties

Thermal Properties

Storage temperature	T_{stg}		-40...+125	°C
Operation temperature under switching condition	T_{jop}		-40...+($T_{jmax} - 25$)	°C

Isolation Properties

Isolation voltage	V_{isol}	DC Test Voltage* $t_p = 2\text{ s}$	6000	V
Isolation voltage	V_{isol}	AC Voltage $t_p = 1\text{ min}$	2500	V
Creepage distance			>12,7	mm
Clearance			8,62	mm
Comparative Tracking Index	CTI		≥ 600	

*100 % tested in production



Vincotech

Characteristic Values

Parameter	Symbol	Conditions					Values			Unit
		V_{GE} [V] V_{GS} [V]	V_{CE} [V] V_{DS} [V] V_F [V]	I_C [A] I_D [A] I_F [A]	T_j [°C]	Min	Typ	Max		

Half-Bridge Switch

Static

Drain-source on-state resistance	$r_{DS(on)}$	15		80	25 125 150	11,2	17 21 23	20,8 ⁽¹⁾	mΩ
Gate-source threshold voltage	$V_{GS(th)}$	0		0,023	25	1,8	2,5	3,6	V
Gate to Source Leakage Current	I_{GSS}	15	0		25		20	500	nA
Zero Gate Voltage Drain Current	I_{DSS}	0	1200		25		2	38	μA
Internal gate resistance	r_g						0,85		Ω
Gate charge	Q_g	-4/15	800	80	25		236		nC
Short-circuit input capacitance	C_{iss}	$f = 100$ kHz	0	1000	0	25	6714		pF
Short-circuit output capacitance	C_{oss}						258		
Reverse transfer capacitance	C_{rss}						16		
Diode forward voltage	V_{SD}	0		40	25		4,6		V

Thermal

Thermal resistance junction to sink ⁽²⁾	$R_{th(j-s)}$	$\lambda_{paste} = 3,4$ W/mK (PSX)					0,57		K/W
--	---------------	---------------------------------------	--	--	--	--	------	--	-----



Vincotech

10-EZ122PA016ME-LJ67F68T
datasheet

Characteristic Values

Parameter	Symbol	Conditions					Values			Unit				
		V_{GE} [V] V_{GS} [V]	V_{CE} [V] V_{DS} [V] V_F [V]	I_C [A] I_D [A] I_F [A]	T_j [°C]	Min	Typ	Max						
Dynamic														
Turn-on delay time	$t_{d(on)}$	$R_{gon} = 2 \Omega$ $R_{goff} = 2 \Omega$	0/15	600	65	25		16,96		ns				
						125		14,72						
						150		14,4						
Rise time	t_r					25		6,72		ns				
						125		6,72						
						150		6,4						
Turn-off delay time	$t_{d(off)}$					25		49,92		ns				
						125		56						
						150		57,6						
Fall time	t_f					25		21,48		ns				
						125		26,48						
						150		25,94						
Turn-on energy (per pulse)	E_{on}					$Q_{rFWD}=0,596 \mu C$ $Q_{rFWD}=1,11 \mu C$ $Q_{rFWD}=1,39 \mu C$				25		0,439		mWs
										125		0,414		
										150		0,409		
Turn-off energy (per pulse)	E_{off}					25		0,173		mWs				
						125		0,189						
						150		0,195						
Peak recovery current	I_{RRM}					25		97,88		A				
						125		141,74						
						150		158,43						
Reverse recovery time	t_{rr}					25		12,51		ns				
						125		15,57						
						150		16,63						
Recovered charge	Q_r	$di/dt=12261 A/\mu s$ $di/dt=13138 A/\mu s$ $di/dt=13187 A/\mu s$				25		0,596		μC				
						125		1,11						
						150		1,39						
Reverse recovered energy	E_{rec}					25		0,152		mWs				
						125		0,321						
						150		0,459						
Peak rate of fall of recovery current	$(di_{rr}/dt)_{max}$					25		25980		A/ μs				
						125		44921						
						150		49283						



Vincotech

Characteristic Values

Parameter	Symbol	Conditions					Values			Unit
		V_{GS} [V]	V_{GE} [V]	V_{DS} [V]	V_{CE} [V]	T_j [°C]	Min	Typ	Max	

Thermistor

Static

Rated resistance	R					25		5		kΩ
Deviation of R_{100}	$A_{R/R}$	$R_{100} = 493 \Omega$				100	-5		5	%
Power dissipation	P							245		mW
Power dissipation constant	d					25		1,4		mW/K
B-value	$B_{(25/50)}$	Tol. $\pm 2 \%$						3375		K
B-value	$B_{(25/100)}$	Tol. $\pm 2 \%$						3437		K
Vincotech Thermistor Reference									K	

⁽¹⁾ Value at chip level

⁽²⁾ Only valid with pre-applied Vincotech thermal interface material.



Half-Bridge Switch Characteristics

figure 1. MOSFET

Typical output characteristics

$$I_D = f(V_{DS})$$

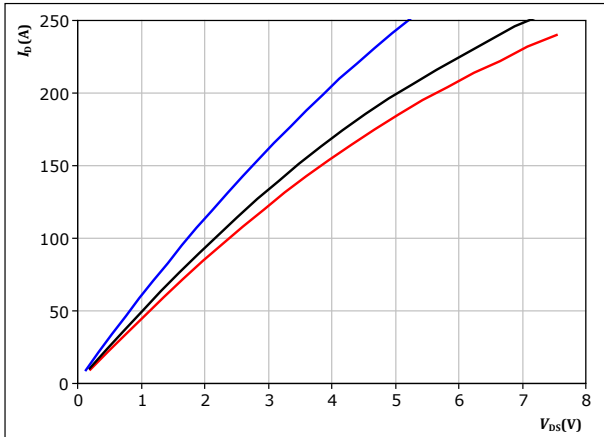

$t_p = 250 \mu s$
 $V_{GS} = 14 V$
 $T_j:$ 25 °C, 125 °C, 150 °C

figure 2. MOSFET

Typical output characteristics

$$I_D = f(V_{DS})$$

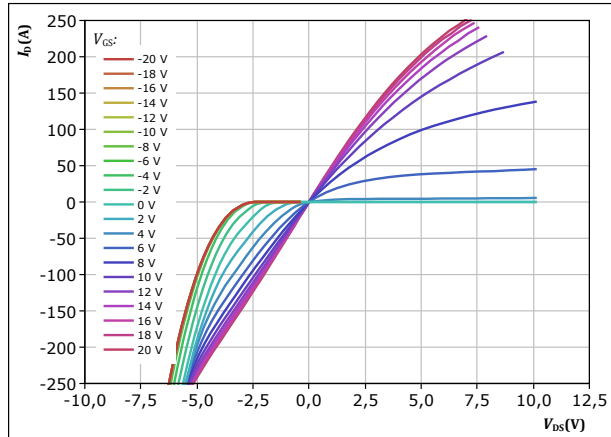

$t_p = 250 \mu s$
 $T_j = 150 \text{ °C}$
 V_{GS} from -20 V to 20 V in steps of 2 V

figure 3. MOSFET

Typical transfer characteristics

$$I_D = f(V_{GS})$$

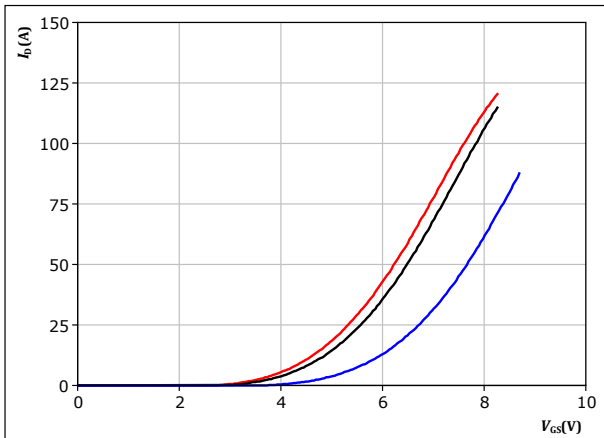

$t_p = 250 \mu s$
 $V_{DS} = 10 V$
 $T_j:$ 25 °C, 125 °C, 150 °C

figure 4. MOSFET

Transient thermal impedance as a function of pulse width

$$Z_{th(j-s)} = f(t_p)$$

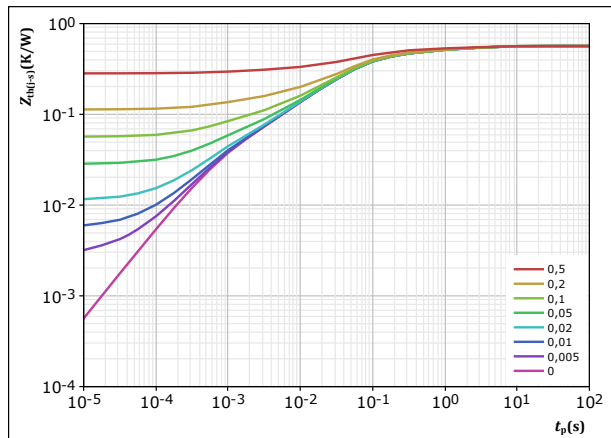

$D = t_p / T$
 $R_{th(j-s)} = 0,566 \text{ K/W}$
MOSFET thermal model values

R (K/W)	τ (s)
6,00E-02	2,94E+00
9,00E-02	4,14E-01
3,09E-01	5,71E-02
7,27E-02	8,33E-03
3,36E-02	7,97E-04



Half-Bridge Switch Characteristics

figure 5. MOSFET

Safe operating area

$$I_D = f(V_{DS})$$

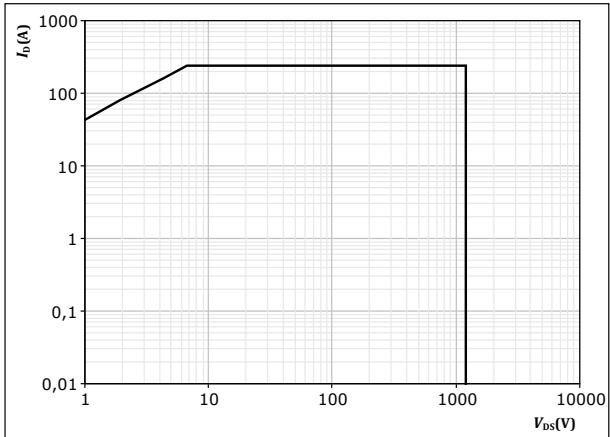

$D =$ single pulse

$T_s = 80$ °C

$V_{GS} = 14$ V

$T_j = T_{jmax}$



Thermistor Characteristics

figure 6. Thermistor

Typical NTC characteristic as function of temperature

$$R_T = f(T)$$

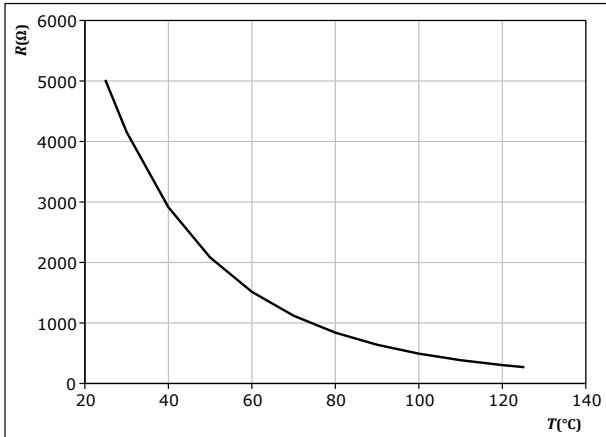



Half-Bridge Switching Characteristics

figure 7. MOSFET

Typical switching energy losses as a function of drain current
 $E = f(I_D)$

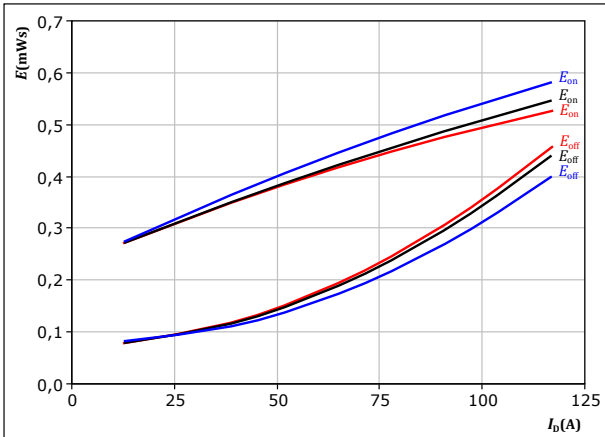

With an inductive load at
 $V_{DS} = 600 \text{ V}$
 $V_{GS} = 0/15 \text{ V}$
 $R_{gon} = 2 \ \Omega$
 $R_{goff} = 2 \ \Omega$

T_j : 25 °C (blue), 125 °C (black), 150 °C (red)

figure 8. MOSFET

Typical switching energy losses as a function of gate resistor
 $E = f(R_g)$

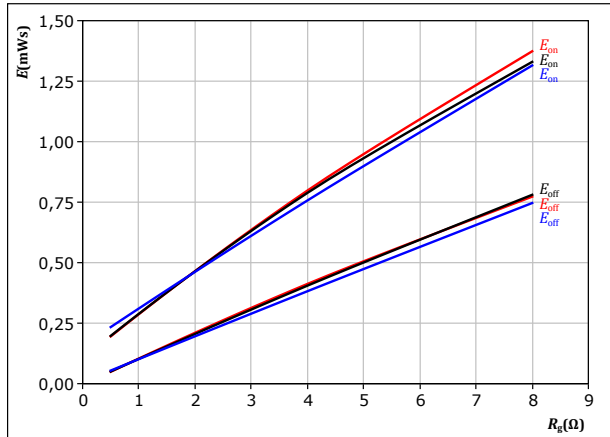

With an inductive load at
 $V_{DS} = 600 \text{ V}$
 $V_{GS} = 0/15 \text{ V}$
 $I_D = 65 \text{ A}$

T_j : 25 °C (blue), 125 °C (black), 150 °C (red)

figure 9. MOSFET

Typical reverse recovered energy loss as a function of drain current
 $E_{rec} = f(I_D)$

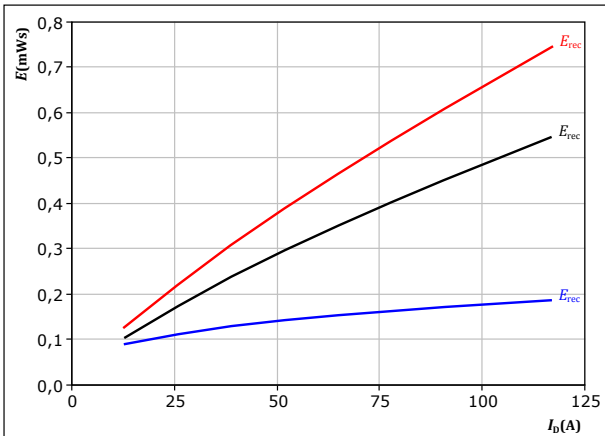

With an inductive load at
 $V_{DS} = 600 \text{ V}$
 $V_{GS} = 0/15 \text{ V}$
 $R_{gon} = 2 \ \Omega$

T_j : 25 °C (blue), 125 °C (black), 150 °C (red)

figure 10. MOSFET

Typical reverse recovered energy loss as a function of gate resistor
 $E_{rec} = f(R_g)$

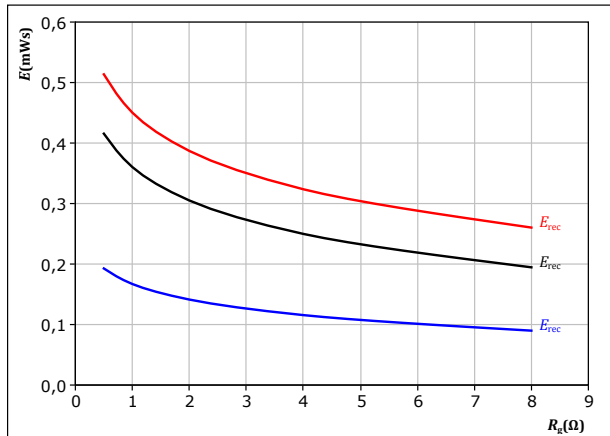

With an inductive load at
 $V_{DS} = 600 \text{ V}$
 $V_{GS} = 0/15 \text{ V}$
 $I_D = 65 \text{ A}$

T_j : 25 °C (blue), 125 °C (black), 150 °C (red)



Half-Bridge Switching Characteristics

figure 11. MOSFET

Typical switching times as a function of drain current
 $t = f(I_D)$

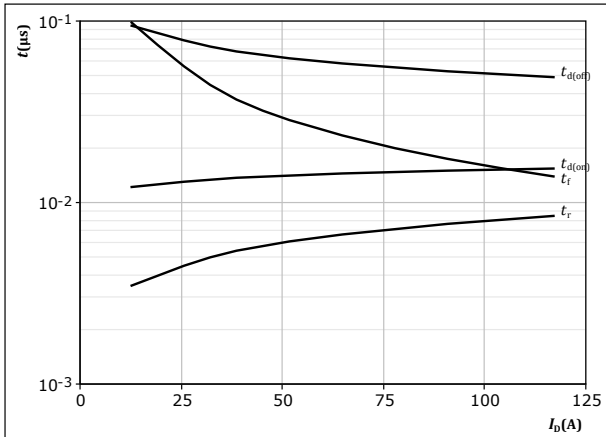

With an inductive load at
 $T_j = 150 \text{ } ^\circ\text{C}$
 $V_{DS} = 600 \text{ V}$
 $V_{GS} = 0/15 \text{ V}$
 $R_{g(on)} = 2 \text{ } \Omega$
 $R_{g(off)} = 2 \text{ } \Omega$

figure 12. MOSFET

Typical switching times as a function of gate resistor
 $t = f(R_g)$

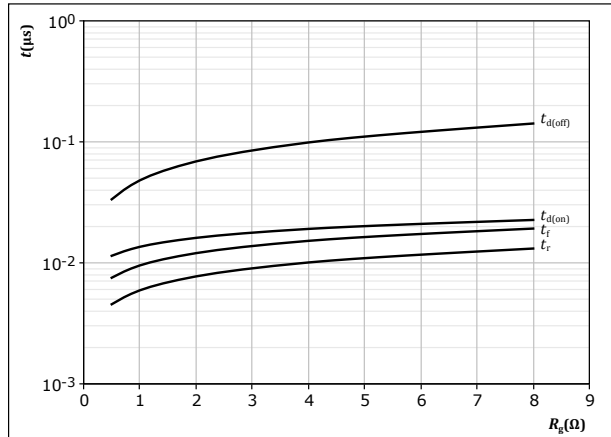

With an inductive load at
 $T_j = 150 \text{ } ^\circ\text{C}$
 $V_{DS} = 600 \text{ V}$
 $V_{GS} = 0/15 \text{ V}$
 $I_D = 65 \text{ A}$

figure 13. MOSFET

Typical reverse recovery time as a function of drain current
 $t_{rr} = f(I_D)$

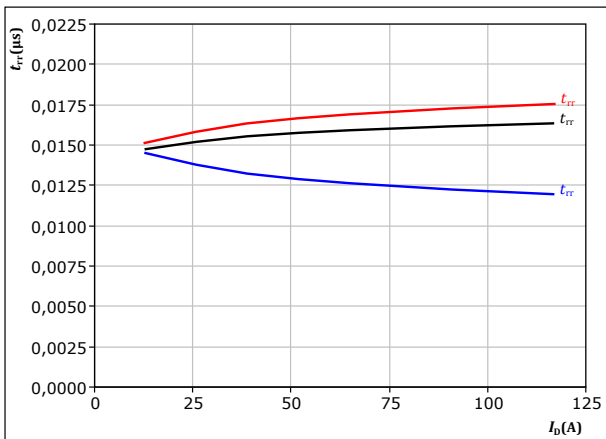

At $V_{DS} = 600 \text{ V}$
 $V_{GS} = 0/15 \text{ V}$
 $R_{g(on)} = 2 \text{ } \Omega$
 $T_j:$ — 25 °C
— 125 °C
— 150 °C

figure 14. MOSFET

Typical reverse recovery time as a function of turn off gate resistor
 $t_{rr} = f(R_{g(off)})$

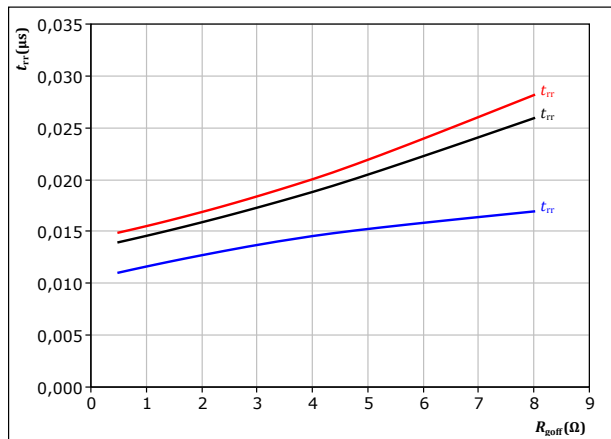

At $V_{DS} = 600 \text{ V}$
 $V_{GS} = 0/15 \text{ V}$
 $I_D = 65 \text{ A}$
 $T_j:$ — 25 °C
— 125 °C
— 150 °C



Half-Bridge Switching Characteristics

figure 15. MOSFET

Typical recovered charge as a function of drain current

$$Q_r = f(I_D)$$

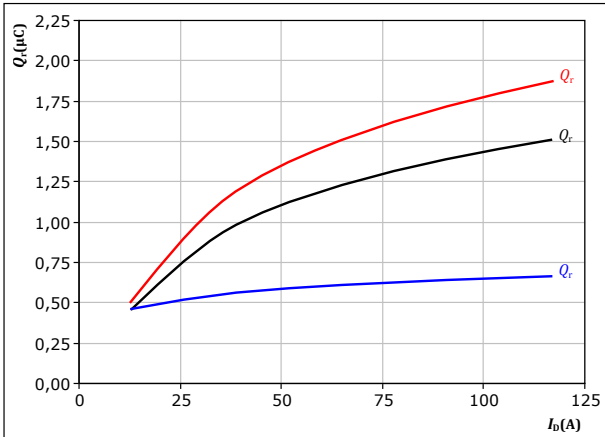

At $V_{DS} = 600$ V
 $V_{GS} = 0/15$ V
 $R_{goff} = 2$ Ω
 T_j : 25 °C (blue), 125 °C (black), 150 °C (red)

figure 16. MOSFET

Typical recovered charge as a function of turn off gate resistor

$$Q_r = f(R_{goff})$$

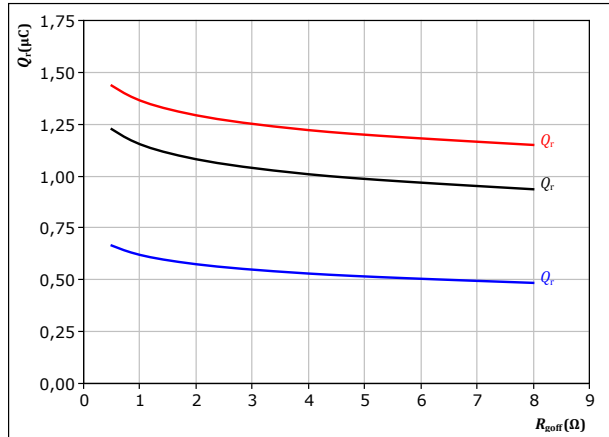

At $V_{DS} = 600$ V
 $V_{GS} = 0/15$ V
 $I_D = 65$ A
 T_j : 25 °C (blue), 125 °C (black), 150 °C (red)

figure 17. MOSFET

Typical peak reverse recovery current as a function of drain current

$$I_{RM} = f(I_D)$$

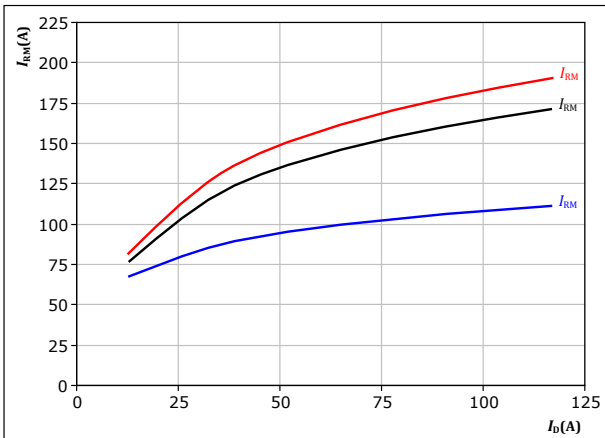

At $V_{DS} = 600$ V
 $V_{GS} = 0/15$ V
 $R_{goff} = 2$ Ω
 T_j : 25 °C (blue), 125 °C (black), 150 °C (red)

figure 18. MOSFET

Typical peak reverse recovery current as a function of turn off gate resistor

$$I_{RM} = f(R_{goff})$$

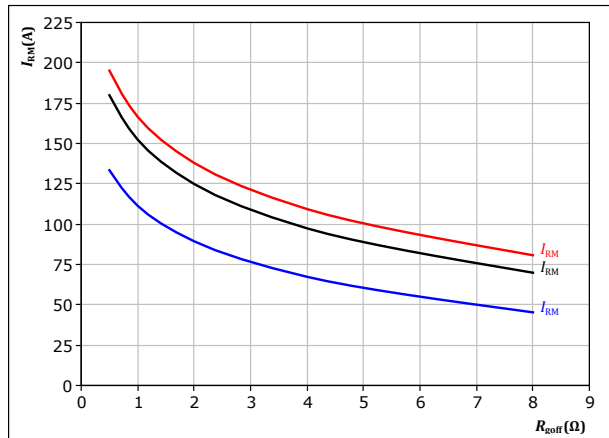

At $V_{DS} = 600$ V
 $V_{GS} = 0/15$ V
 $I_D = 65$ A
 T_j : 25 °C (blue), 125 °C (black), 150 °C (red)



Half-Bridge Switching Characteristics

figure 19. MOSFET

Typical rate of fall of forward and reverse recovery current as a function of drain current
 $di_f/dt, di_{rr}/dt = f(I_D)$

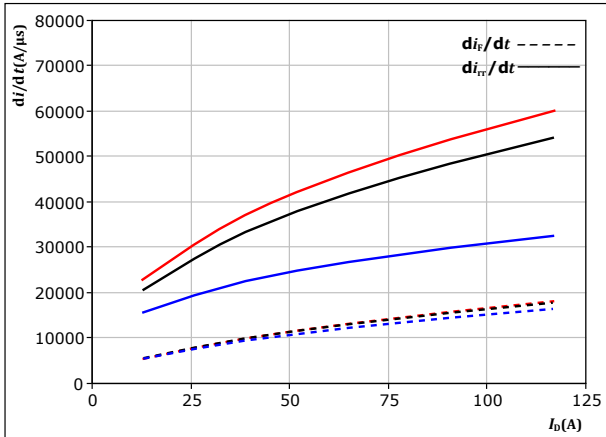

At $V_{DS} = 600$ V
 $V_{GS} = 0/15$ V
 $R_{goff} = 2$ Ω

T_j : 25 °C (blue)
 125 °C (black)
 150 °C (red)

figure 20. MOSFET

Typical rate of fall of forward and reverse recovery current as a function of turn off gate resistor
 $di_f/dt, di_{rr}/dt = f(R_{goff})$

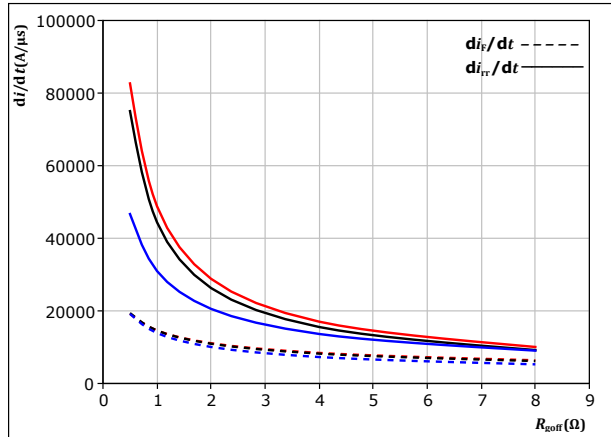

At $V_{DS} = 600$ V
 $V_{GS} = 0/15$ V
 $I_D = 65$ A

T_j : 25 °C (blue)
 125 °C (black)
 150 °C (red)

figure 21. MOSFET

Reverse bias safe operating area

$I_D = f(V_{DS})$

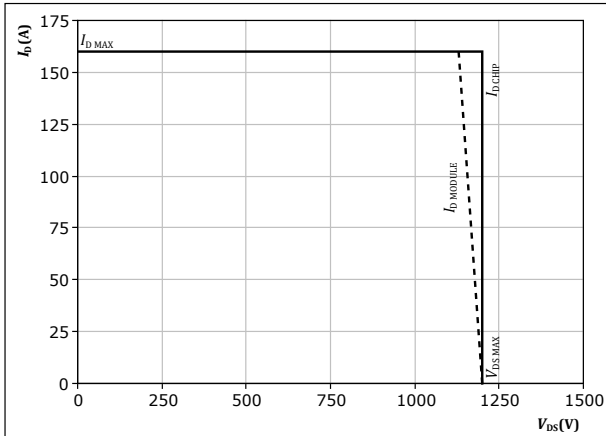

At $T_j = 150$ °C
 $R_{goff} = 2$ Ω
 $R_{goff} = 2$ Ω



Half-Bridge Switching Definitions

figure 22. MOSFET

Turn-off Switching Waveforms & definition of t_{doff} , t_{Eoff} (t_{Eoff} = integrating time for E_{off})

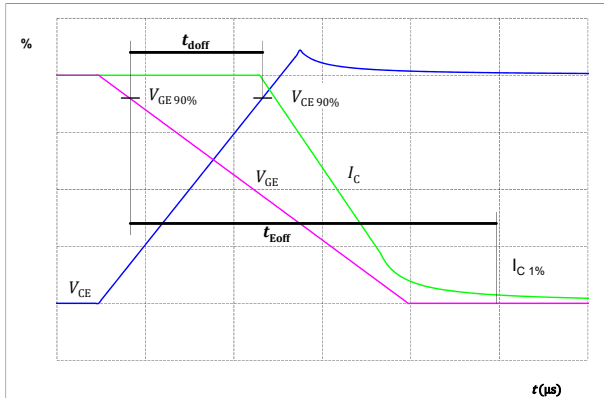

figure 23. MOSFET

Turn-on Switching Waveforms & definition of t_{don} , t_{Eon} (t_{Eon} = integrating time for E_{on})

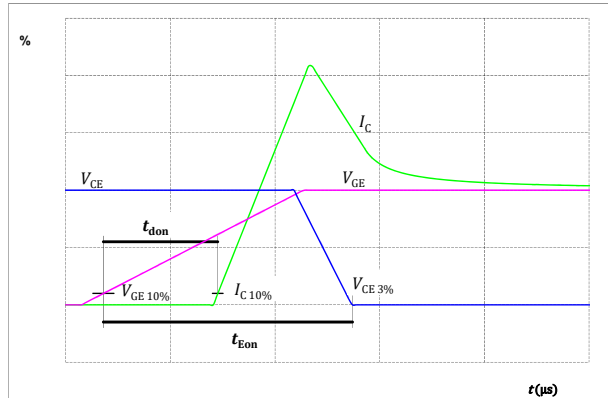

figure 24. MOSFET

Turn-off Switching Waveforms & definition of t_f

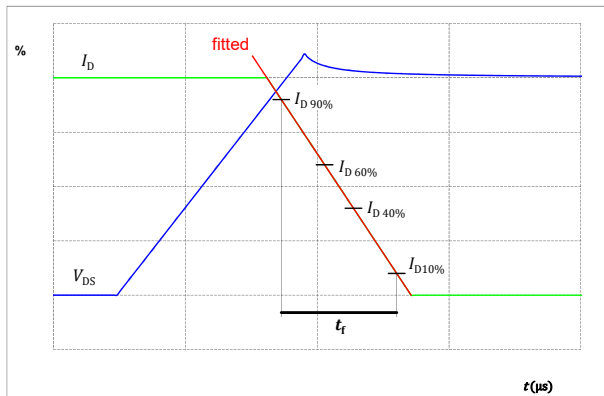
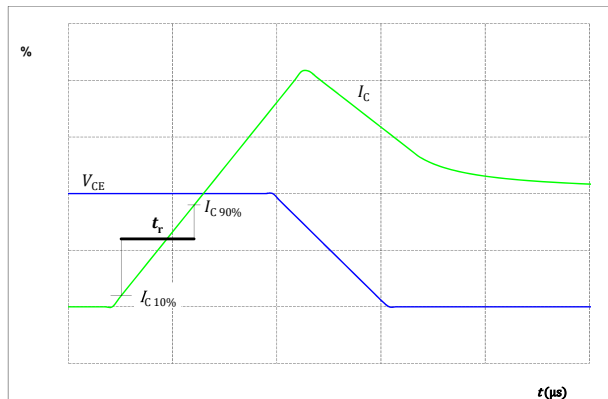

figure 25. MOSFET

Turn-on Switching Waveforms & definition of t_r





Half-Bridge Switching Definitions

figure 26. FWD

Turn-off Switching Waveforms & definition of t_{tr}

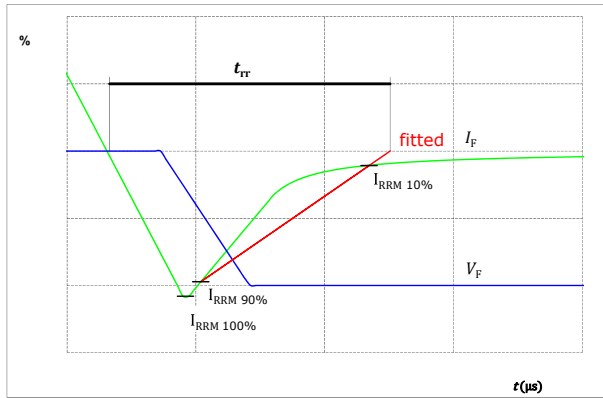

figure 27. FWD

Turn-on Switching Waveforms & definition of t_{Qr} (t_{Qr} = integrating time for Q_r)

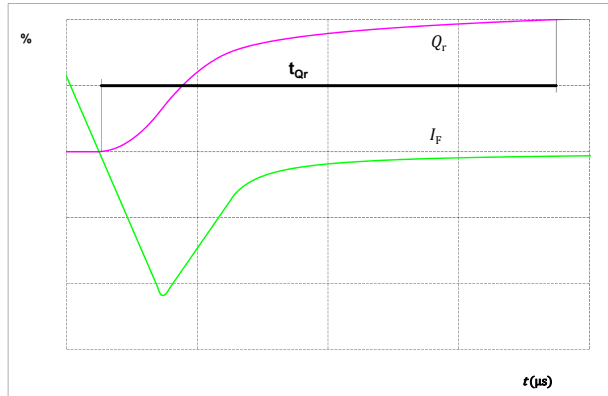
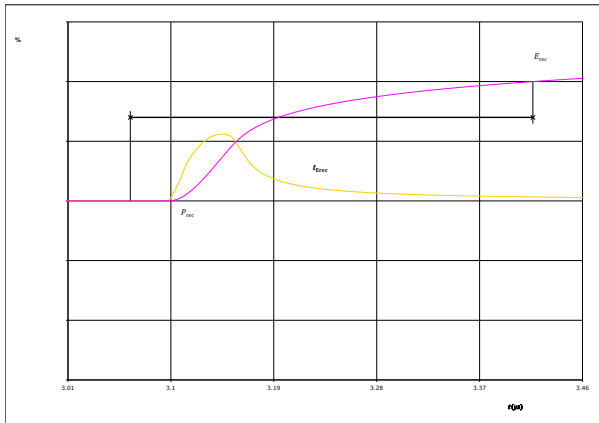

figure 28. FWD

Turn-on Switching Waveforms & definition of t_{Erec} (t_{Erec} = integrating time for E_{rec})





Vincotech

10-EZ122PA016ME-LJ67F68T
datasheet

Ordering Code	
Version	Ordering Code
Without thermal paste	10-EZ122PA016ME-LJ67F68T
With thermal paste	10-EZ122PA016ME-LJ67F68T-/3/

Marking						
	Text	Name NN-NNNNNNNNNNNNNN- TTTTTV	Date code WWYY	UL & VIN UL VIN	Lot LLLLL	Serial SSSS
	Datamatrix	Type&Ver TTTTTTTV	Lot number LLLLL	Serial SSSS	Date code WWYY	

Pin table [mm]				Outline
Pin	X	Y	Function	
1	32	3,2	DC+	
2	32	6,4	DC+	
3	32	22,4	Ph	
4	32	25,6	Ph	
5	19,2	0	S12	
6	19,2	3,2	G12	
7	25,6	12,8	DC-	
8	22,4	12,8	DC-	
9	19,2	12,8	DC-	
10	12,8	12,8	DC-	
11	19,2	22,4	G11	
12	19,2	25,6	S11	
13	6,4	3,2	DC+	
14	6,4	6,4	DC+	
15	6,4	22,4	Ph	
16	6,4	25,6	Ph	
17	0	12,8	Therm2	
18	0	16	Therm1	

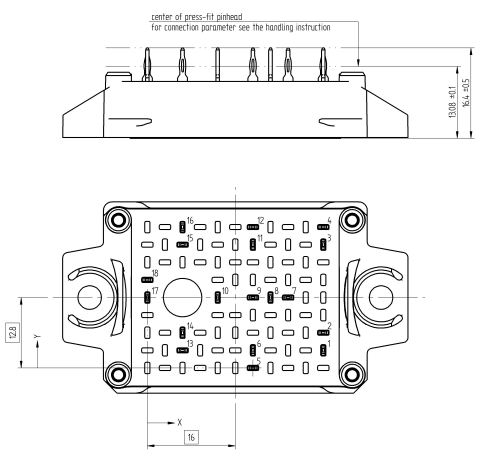

center of press-fit pinhead
For connection parameter see the handling instruction

0,389 ±0,012
0,64 ±0,012

0,25
0,16

Tolerance of pinpositions: ±0,4mm at the end of pins
Dimension of coordinate axis is only offset without tolerance

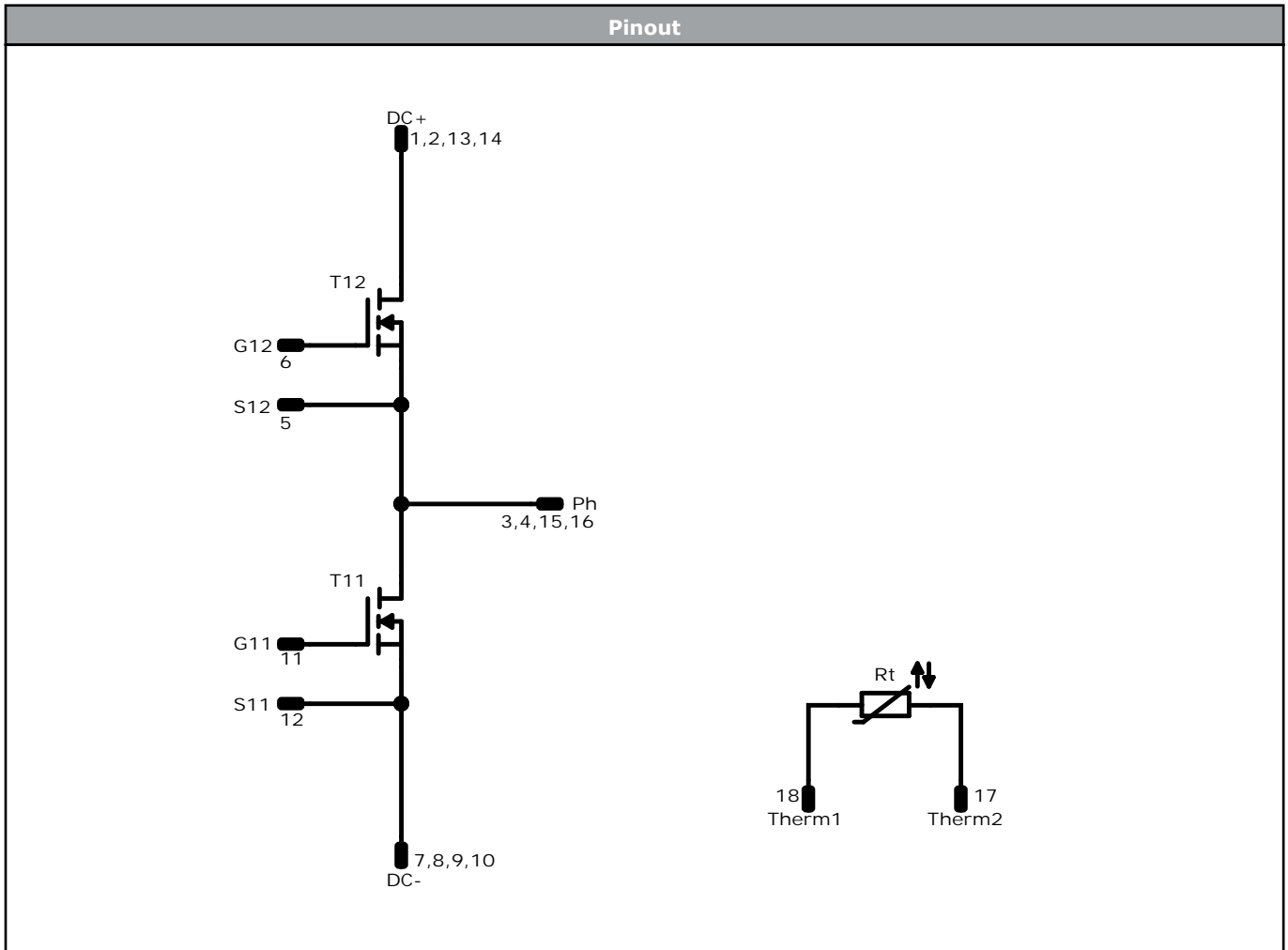

Identification					
ID	Component	Voltage	Current	Function	Comment
T11, T12	MOSFET	1200 V	16 mΩ	Half-Bridge Switch	
Rt	Thermistor			Thermistor	



Packaging instruction				
Standard packaging quantity (SPQ) 100	>SPQ	Standard	<SPQ	Sample

Handling instruction
Handling instructions for <i>flow</i> E1 packages see vincotech.com website.

Package data
Package data for <i>flow</i> E1 packages see vincotech.com website.

Vincotech thermistor reference
See Vincotech thermistor reference table at vincotech.com website.

UL recognition and file number
This device is certified according to UL 1557 standard, UL file number E192116. For more information see vincotech.com website. 

Document No.:	Date:	Modification:	Pages
10-EZ122PA016ME-LJ67F68T-D1-14	19 May, 2021		

DISCLAIMER

The information, specifications, procedures, methods and recommendations herein (together "information") are presented by Vincotech to reader in good faith, are believed to be accurate and reliable, but may well be incomplete and/or not applicable to all conditions or situations that may exist or occur. Vincotech reserves the right to make any changes without further notice to any products to improve reliability, function or design. No representation, guarantee or warranty is made to reader as to the accuracy, reliability or completeness of said information or that the application or use of any of the same will avoid hazards, accidents, losses, damages or injury of any kind to persons or property or that the same will not infringe third parties rights or give desired results. It is reader's sole responsibility to test and determine the suitability of the information and the product for reader's intended use.

LIFE SUPPORT POLICY

Vincotech products are not authorised for use as critical components in life support devices or systems without the express written approval of Vincotech.

As used herein:

1. Life support devices or systems are devices or systems which, (a) are intended for surgical implant into the body, or (b) support or sustain life, or (c) whose failure to perform when properly used in accordance with instructions for use provided in labelling can be reasonably expected to result in significant injury to the user.
2. A critical component is any component of a life support device or system whose failure to perform can be reasonably expected to cause the failure of the life support device or system, or to affect its safety or effectiveness.

单击下面可查看定价，库存，交付和生命周期等信息

[>>Vincotech\(威科\)](#)