

RS RELAYS

3 GHz capable, 10 W carrying power (at 3 GHz), 50/75 Ω, 1 Form C Relays

Protective construction : Sealed type

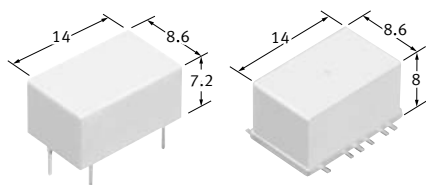

(Unit : mm)

FEATURES

- Excellent high frequency characteristics (50/75 Ω, up to 3 GHz)
- Lineup includes quiet type and reversed contact type.
- Compact size: 8.6(W) × 14(L) × 8(H) mm

TYPICAL APPLICATIONS

- Broadcasting and video equipment
- Communication and measurement equipment
- Mobile phone base stations

Note: If you consider using applications with low level loads or with high frequency switching, please consult us.

HIGH FREQUENCY CHARACTERISTICS

■ 50 Ω (Initial)

● PC board terminal

Frequency	Up to 900 MHz	Up to 3 GHz
V.S.W.R. (Max.)	1.2	1.4
Insertion loss (dB, Max.)	0.1	0.35
Isolation (dB, Min.)	60	35

● Surface mount terminal

Frequency	Up to 900 MHz	Up to 3 GHz
V.S.W.R. (Max.)	1.2	1.4
Insertion loss (dB, Max.)	0.2	0.4
Isolation (dB, Min.)	55	30

■ 75 Ω (Initial)

● PC board terminal

Frequency	Up to 900 MHz	Up to 3 GHz
V.S.W.R. (Max.)	1.15	1.4
Insertion loss (dB, Max.)	0.1	0.3
Isolation (dB, Min.)	60	30

● Surface mount terminal

Frequency	Up to 900 MHz	Up to 3 GHz
V.S.W.R. (Max.)	1.2	1.5
Insertion loss (dB, Max.)	0.2	0.5
Isolation (dB, Min.)	55	30

ORDERING INFORMATION (PART NO.)

ARS

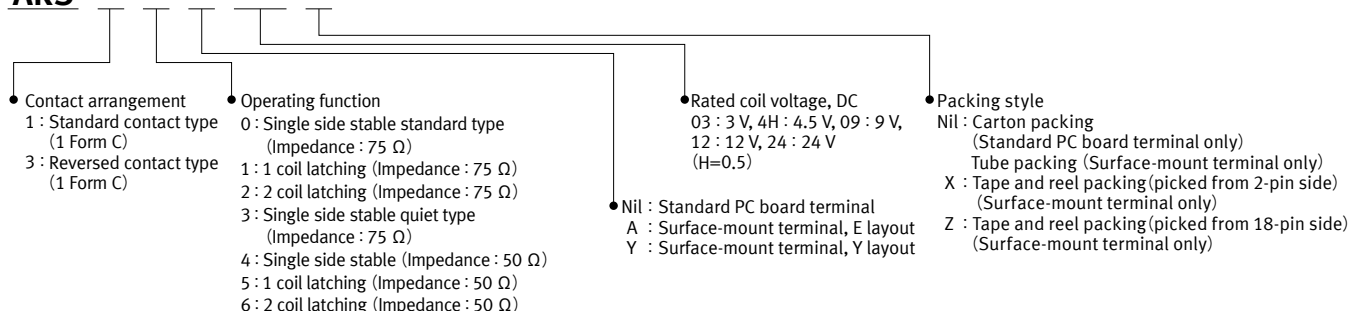

Note : Packing style symbol "X", "Z" is not marked on the relay.

TYPES

■ PC board terminal

● Standard contact: Carton packing

Contact arrangement	Impedance	Rated coil voltage	Part No.				Standard packing	
			Standard type			Quiet type	Inner carton	Outer carton
			Single side stable	1 coil latching	2 coil latching	Single side stable		
1 Form C	50 Ω	3 V DC	ARS1403	ARS1503	ARS1603	-	50 pcs.	500 pcs.
		4.5 V DC	ARS144H	ARS154H	ARS164H	-		
		9 V DC	ARS1409	ARS1509	ARS1609	-		
		12 V DC	ARS1412	ARS1512	ARS1612	-		
		24 V DC	ARS1424	ARS1524	ARS1624	-		
	75 Ω	3 V DC	ARS1003	ARS1103	ARS1203	ARS1303		
		4.5 V DC	ARS104H	ARS114H	ARS124H	ARS134H		
		9 V DC	ARS1009	ARS1109	ARS1209	ARS1309		
		12 V DC	ARS1012	ARS1112	ARS1212	ARS1312		
		24 V DC	ARS1024	ARS1124	ARS1224	ARS1324		

● Reverse contact: Carton packing

Contact arrangement	Impedance	Rated coil voltage	Part No.				Standard packing	
			Standard type			Quiet type	Inner carton	Outer carton
			Single side stable	1 coil latching	2 coil latching	Single side stable		
1 Form C	50 Ω	3 V DC	ARS3403	ARS3503	ARS3603	-	50 pcs.	500 pcs.
		4.5 V DC	ARS344H	ARS354H	ARS364H	-		
		9 V DC	ARS3409	ARS3509	ARS3609	-		
		12 V DC	ARS3412	ARS3512	ARS3612	-		
		24 V DC	ARS3424	ARS3524	ARS3624	-		
	75 Ω	3 V DC	ARS3003	ARS3103	ARS3203	ARS3303		
		4.5 V DC	ARS304H	ARS314H	ARS324H	ARS334H		
		9 V DC	ARS3009	ARS3109	ARS3209	ARS3309		
		12 V DC	ARS3012	ARS3112	ARS3212	ARS3312		
		24 V DC	ARS3024	ARS3124	ARS3224	ARS3324		

■ Surface mount terminal

● Standard contact: Tube packing, Tape and reel packing

Pin layout	Contact arrangement	Impedance	Rated coil voltage	Part No.			Standard packing		
				Single side stable	1 coil latching	2 coil latching	Inner carton (1-tube)	Inner carton (1-reel)	Outer carton
E layout	1 Form C	50 Ω	3 V DC	ARS14A03*	ARS15A03*	ARS16A03*	40 pcs.	500 pcs.	1,000 pcs.
			4.5 V DC	ARS14A4H*	ARS15A4H*	ARS16A4H*			
			9 V DC	ARS14A09*	ARS15A09*	ARS16A09*			
			12 V DC	ARS14A12*	ARS15A12*	ARS16A12*			
			24 V DC	ARS14A24*	ARS15A24*	ARS16A24*			
		75 Ω	3 V DC	ARS10A03*	ARS11A03*	ARS12A03*			
			4.5 V DC	ARS10A4H*	ARS11A4H*	ARS12A4H*			
			9 V DC	ARS10A09*	ARS11A09*	ARS12A09*			
			12 V DC	ARS10A12*	ARS11A12*	ARS12A12*			
			24 V DC	ARS10A24*	ARS11A24*	ARS12A24*			
Y layout	1 Form C	50 Ω	3 V DC	ARS14Y03*	ARS15Y03*	ARS16Y03*			
			4.5 V DC	ARS14Y4H*	ARS15Y4H*	ARS16Y4H*			
			9 V DC	ARS14Y09*	ARS15Y09*	ARS16Y09*			
			12 V DC	ARS14Y12*	ARS15Y12*	ARS16Y12*			
			24 V DC	ARS14Y24*	ARS15Y24*	ARS16Y24*			
		75 Ω	3 V DC	ARS10Y03*	ARS11Y03*	ARS12Y03*			
			4.5 V DC	ARS10Y4H*	ARS11Y4H*	ARS12Y4H*			
			9 V DC	ARS10Y09*	ARS11Y09*	ARS12Y09*			
			12 V DC	ARS10Y12*	ARS11Y12*	ARS12Y12*			
			24 V DC	ARS10Y24*	ARS11Y24*	ARS12Y24*			

Note: Please add "Tube packing: Nil", "Tape and reel packing (picked from 2-pin side): X" or "Tape and reel packing (picked from 18-pin side): Z" in place of the asterisk at the end of the part number.

● Reverse contact: Tube packing, Tape and reel packing

Pin layout	Contact arrangement	Impedance	Rated coil voltage	Part No.			Standard packing		
				Single side stable	1 coil latching	2 coil latching	Inner carton (1-tube)	Inner carton (1-reel)	Outer carton
E layout	1 Form C	50 Ω	3 V DC	ARS34A03*	ARS35A03*	ARS36A03*	40 pcs.	500 pcs.	1,000 pcs.
			4.5 V DC	ARS34A4H*	ARS35A4H*	ARS36A4H*			
			9 V DC	ARS34A09*	ARS35A09*	ARS36A09*			
			12 V DC	ARS34A12*	ARS35A12*	ARS36A12*			
			24 V DC	ARS34A24*	ARS35A24*	ARS36A24*			
		75 Ω	3 V DC	ARS30A03*	ARS31A03*	ARS32A03*			
			4.5 V DC	ARS30A4H*	ARS31A4H*	ARS32A4H*			
			9 V DC	ARS30A09*	ARS31A09*	ARS32A09*			
			12 V DC	ARS30A12*	ARS31A12*	ARS32A12*			
			24 V DC	ARS30A24*	ARS31A24*	ARS32A24*			
Y layout	1 Form C	50 Ω	3 V DC	ARS34Y03*	ARS35Y03*	ARS36Y03*			
			4.5 V DC	ARS34Y4H*	ARS35Y4H*	ARS36Y4H*			
			9 V DC	ARS34Y09*	ARS35Y09*	ARS36Y09*			
			12 V DC	ARS34Y12*	ARS35Y12*	ARS36Y12*			
			24 V DC	ARS34Y24*	ARS35Y24*	ARS36Y24*			
		75 Ω	3 V DC	ARS30Y03*	ARS31Y03*	ARS32Y03*			
			4.5 V DC	ARS30Y4H*	ARS31Y4H*	ARS32Y4H*			
			9 V DC	ARS30Y09*	ARS31Y09*	ARS32Y09*			
			12 V DC	ARS30Y12*	ARS31Y12*	ARS32Y12*			
			24 V DC	ARS30Y24*	ARS31Y24*	ARS32Y24*			

Note: Please add "Tube packing: Nil", "Tape and reel packing (picked from 2-pin side): X" or "Tape and reel packing (picked from 18-pin side): Z" in place of the asterisk at the end of the part number.

RATING

■ Coil data

- Operating characteristics such as 'Operate voltage' and 'Release voltage' are influenced by mounting conditions, ambient temperature, etc.

Therefore, please use the relay within $\pm 5\%$ of rated coil voltage.

- 'Initial' means the condition of products at the time of delivery.

● Single side stable

Rated coil voltage	Operate voltage* (at 20 °C)	Release voltage* (at 20 °C)	Rated operating current ($\pm 10\%$, at 20 °C)	Coil resistance ($\pm 10\%$, at 20 °C)	Rated operating power	Max. allowable voltage
3 V DC	Max. 75% V of rated coil voltage (Initial)	Min. 10% V of rated coil voltage (Initial)	66.7 mA	45 Ω	200 mW	110% V (at 60 °C) 150% V (at 20 °C) of rated coil voltage
4.5 V DC			44.4 mA	101.3 Ω		
9 V DC			22.2 mA	405 Ω		
12 V DC			16.7 mA	720 Ω		
24 V DC			8.3 mA	2,880 Ω		

*square, pulse drive

● 1 coil latching

Rated coil voltage	Set voltage* (at 20 °C)	Reset voltage* (at 20 °C)	Rated operating current ($\pm 10\%$, at 20 °C)	Coil resistance ($\pm 10\%$, at 20 °C)	Rated operating power	Max. allowable voltage
3 V DC	Max. 75% V of rated coil voltage (Initial)	Max. 75% V of rated coil voltage (Initial)	66.7 mA	45 Ω	200 mW	110% V (at 60 °C) 150% V (at 20 °C) of rated coil voltage
4.5 V DC			44.4 mA	101.3 Ω		
9 V DC			22.2 mA	405 Ω		
12 V DC			16.7 mA	720 Ω		
24 V DC			8.3 mA	2,880 Ω		

*square, pulse drive

● 2 coil latching

Rated coil voltage	Set voltage* (at 20 °C)	Reset voltage* (at 20 °C)	Rated operating current ($\pm 10\%$, at 20 °C)	Coil resistance ($\pm 10\%$, at 20 °C)	Rated operating power	Max. allowable voltage
3 V DC	Max. 75% V of rated coil voltage (Initial)	Max. 75% V of rated coil voltage (Initial)	133.3 mA	22.5 Ω	400 mW	110% V (at 60 °C) 150% V (at 20 °C) of rated coil voltage
4.5 V DC			88.9 mA	50.6 Ω		
9 V DC			44.4 mA	202.5 Ω		
12 V DC			33.3 mA	360 Ω		
24 V DC			16.7 mA	1,440 Ω		

*square, pulse drive

Specifications

Item		Specifications
Contact data	Contact arrangement	1 Form C
	Contact resistance (initial)	Max. 100 mΩ (by voltage drop 10 V AC 10 mA)
	Contact material	Au plating
	Contact rating	1 W (3 GHz, 50/75 Ω, V.S.W.R.: Max. 1.4), 10 mA 24 V DC (resistive)
	Contact input power (CW)	Max. 10 W (3 GHz, 50/75 Ω, V.S.W.R.: Max. 1.4)
	Max. switching voltage	30 V DC
	Max. switching current	0.5 A (DC)
Insulation resistance (initial)		Min. 100 MΩ (at 500 V DC, Measured portion is the same as the case of dielectric strength.)
Dielectric strength (initial)	Between open contacts	500 Vrms for 1 min (detection current: 10 mA)
	Between contact and coil	1,000 Vrms for 1 min (detection current: 10 mA)
	Between contact and ground	500 Vrms for 1 min (detection current: 10 mA)
Time characteristics (initial)	Operate (Set) time	Max. 10 ms (Max. 10 ms) at rated coil voltage (at 20 °C, without bounce)
	Release (Reset) time	Max. 6 ms at rated coil voltage (at 20 °C, without bounce, without diode) [Max. 10 ms (at 20 °C, without bounce)]
Shock resistance	Functional	196 m/s ² (half-sine shock pulse: 11 ms, detection time: 10 μs)
	Destructive	980 m/s ² (half-sine shock pulse: 6 ms)
Vibration resistance	Functional	10 to 55 Hz (at double amplitude of 3 mm, detection time: 10 μs)
	Destructive	10 to 55 Hz (at double amplitude of 5 mm)
Operation noise (initial)* ¹		Single side stable, Standard type: Approx. 40 dB (at 20 °C) Single side stable, Quiet type: Approx. 30 dB (at 20 °C) Latching: Approx. 40 dB (at 20 °C)
Expected life	Mechanical life (Cold switch)	Single side stable, Standard type: Min. 5 x 10 ⁶ (switching frequency: 180 times/min) Single side stable, Quiet type: Min. 10 ⁶ (switching frequency: 180 times/min) Latching: Min. 10 ⁶ (switching frequency: 180 times/min)
Conditions	Conditions for usage, transport and storage*	Ambient temperature: -40 to +70 °C (Single side stable, Standard type, Latching) (Allowable temperature is from -40 to +70 °C at our standard packing condition.) -40 to +60 °C (Single side stable, Quiet type) (Allowable temperature is from -40 to +60 °C at our standard packing condition.) Humidity: 5 to 85% RH (Avoid icing and condensation)
Unit weight		Approx. 2 g

*1. Measured the operation noise of the relay alone (with diodes at both ends of the coil) 30 cm away from top side, by the A-weighted, FAST method while applying the rated voltage.

*2. For ambient temperature, please read "GUIDELINES FOR RELAY USAGE".

Electrical life (Hot switch)

● 50 Ω

Conditions: Switching frequency 20 times/min

Type	Load	Switching capacity	Number of operations	
1 Form C	PC board terminal	Resistive load	10 mA 10 V DC Min. 10 ⁶	
		High frequency load	10 mA 24 V DC Min. 300 x 10 ³	
	Surface mount terminal	Resistive load	1 W (3 GHz, 50 Ω, V.S.W.R.: Max. 1.4)	Min. 10 ⁶
			10 mA 10 V DC Min. 300 x 10 ³	
		High frequency load	10 mA 24 V DC Min. 300 x 10 ³	
			1 W (3 GHz, 50 Ω, V.S.W.R.: Max. 1.4)	Min. 300 x 10 ³

● 75 Ω

Conditions: Switching frequency 20 times/min

Type	Load	Switching capacity	Number of operations
1 Form C	Resistive load	10 mA 24 V DC	Min. 300 x 10 ³
	High frequency load	1 W (3 GHz, 75 Ω, V.S.W.R.: 1.4)	Min. 300 x 10 ³

REFERENCE DATA

1-1.High frequency characteristics (50 Ω, PC board terminal)

Sample : ARS144H

Measuring method : See "Measuring method" under "NOTES".

V.S.W.R. characteristics

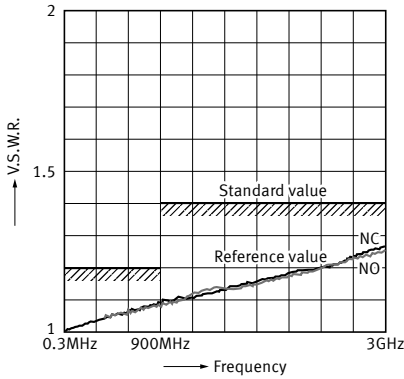

Insertion loss characteristics (without D.U.T. board's loss)

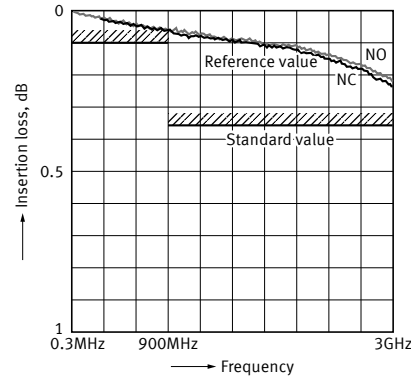

Isolation characteristics

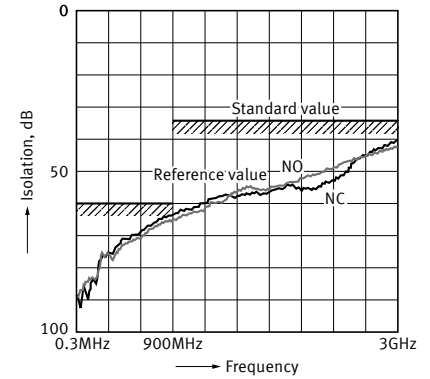

1-2.High frequency characteristics (75 Ω, PC board terminal)

Sample : ARS104H

Measuring method : See "Measuring method" under "NOTES".

V.S.W.R. characteristics

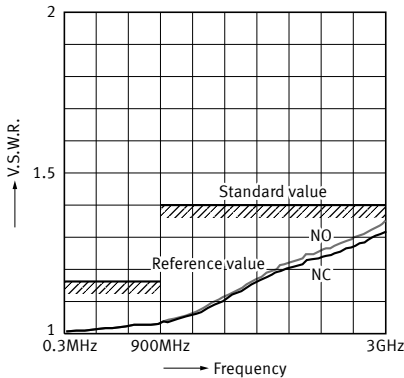

Insertion loss characteristics (without D.U.T. board's loss)

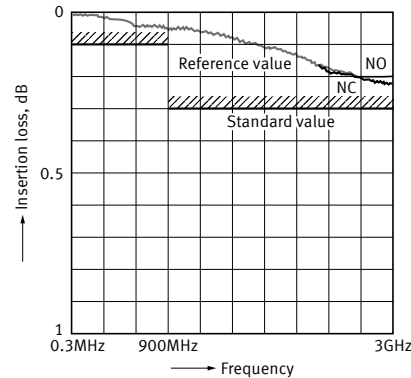

Isolation characteristics

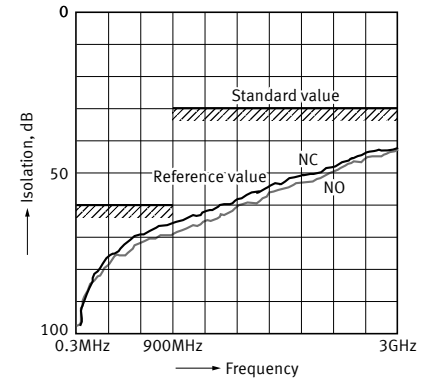

1-3.High frequency characteristics (50 Ω, Surface mount terminal)

Sample : ARS14A4H

Measuring method : See "Measuring method" under "NOTES".

V.S.W.R. characteristics

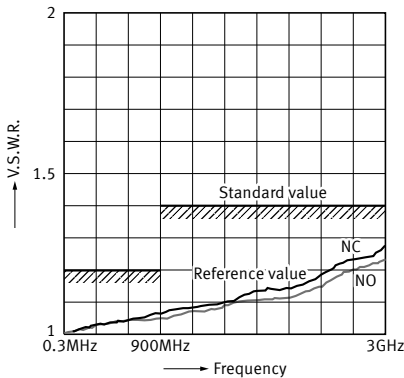

Insertion loss characteristics (without D.U.T. board's loss)

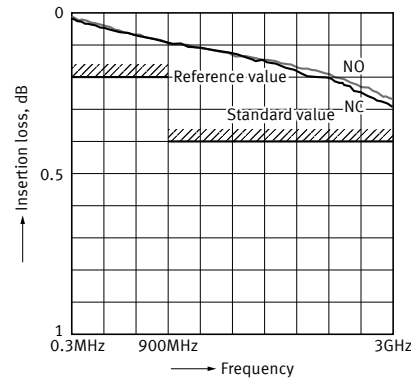

Isolation characteristics

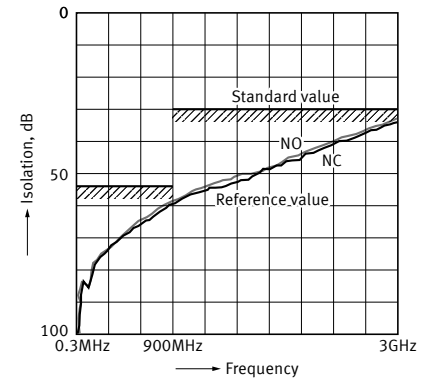

1-4.High frequency characteristics (75 Ω, Surface mount terminal)

Sample : ARS10A4H
 Measuring method : See "Measuring method" under "NOTES".

V.S.W.R. characteristics

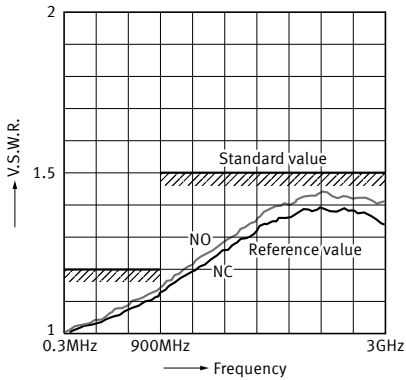

Insertion loss characteristics (without D.U.T. board's loss)

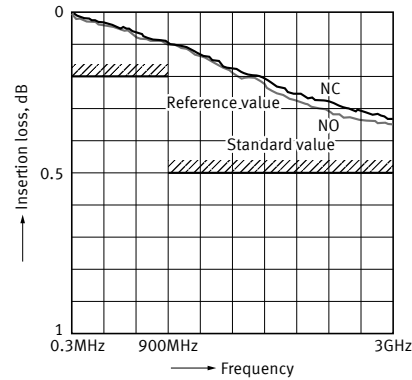

Isolation characteristics

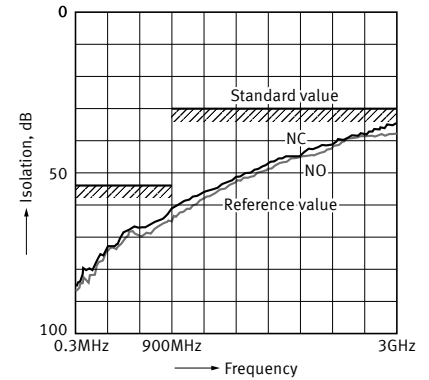

2-1.Distribution of operation noise

Sample : ARS134H (single side stable quiet type), 50 pcs.
 Coil voltage : rated voltage applied (with diode)
 Equipment setting : A weighted sound pressure level, FAST.
 Background noise : approx. 20 dB
 Method of measurement : See figure below.

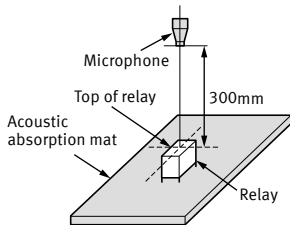

When operated

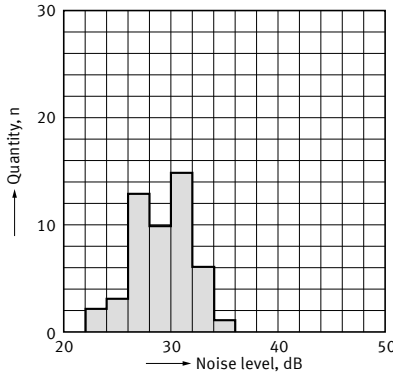

When released

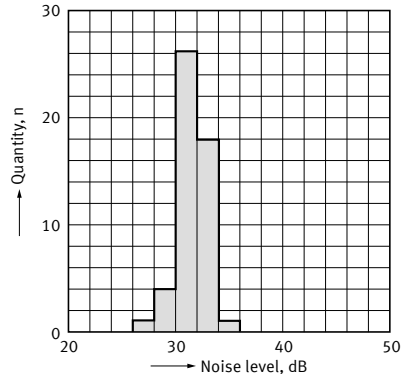

2-2.Distribution of operation noise

Sample : ARS104H (single side stable standard type), 50 pcs.
 Coil voltage : rated voltage applied (with diode)
 Equipment setting : A weighted sound pressure level, FAST.
 Background noise : approx. 20 dB
 Method of measurement : See figure below.

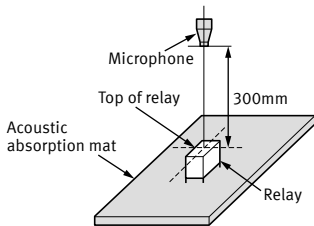

When operated

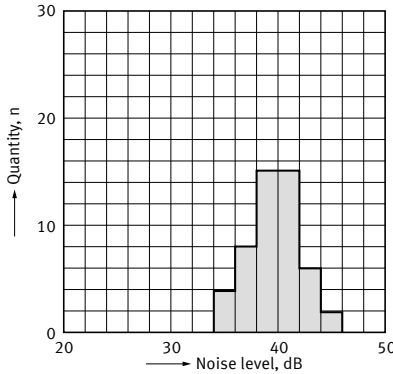

When released

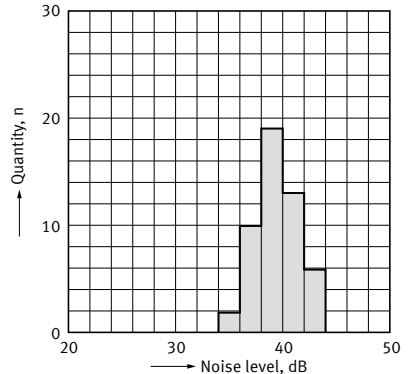

2-3.Distribution of operation noise

Sample : ARS114H (latching type), 50 pcs.
 Coil voltage : rated voltage applied (with diode)
 Equipment setting : A weighted sound pressure level, FAST.
 Background noise : approx. 20 dB
 Method of measurement : See figure below.

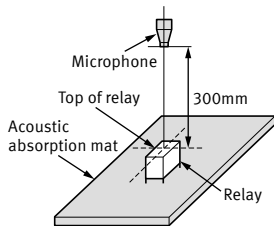

When set and reset

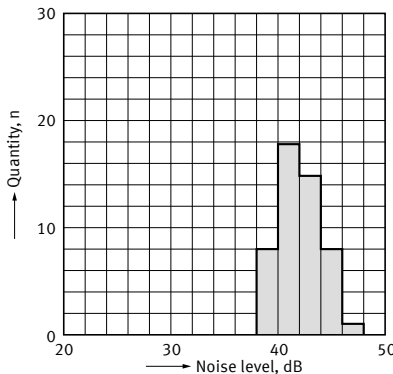

MEASURING METHOD OF HIGH FREQUENCY CHARACTERISTICS

Unit: mm

50 Ω

Measuring method

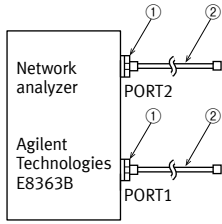

No.	Product name	Contents
1	Agilent 85130-60011	Adapter 2.4 - 3.5 mm female
2	SUHNER SUCOFLEX104	Cable 3.5 - 3.5 mm male

- 1) Connect connectors 1 and 2 respectively to PORT1 and PORT2.
Perform calibration using the 3.5 mm calibration kit.
- 2) After calibration, connect the D.U.T board and measure.
However, connectors other than those for measurement should be connected with 50 Ω termination resistor.

D.U.T board

Material	Glass PTFE double-sided through hole PC board R-4737 (manufactured by our company)
Board thickness	t = 0.8 mm
Copper plating thickness	18 μm

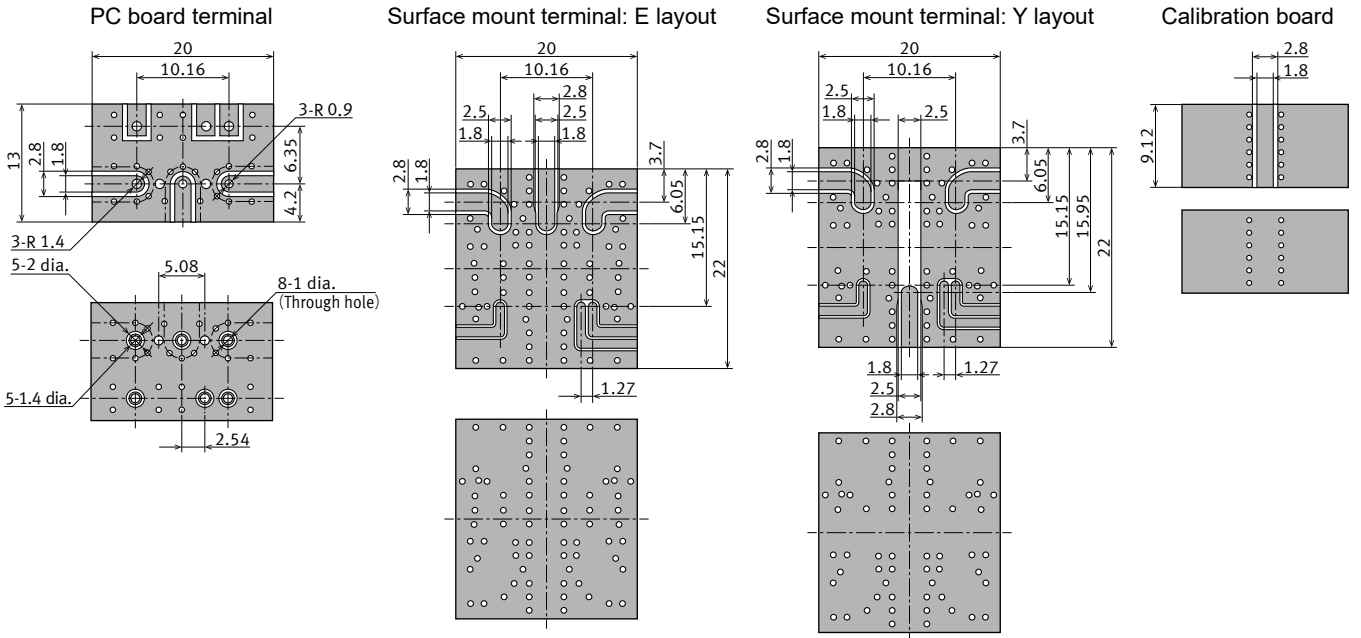

Connector (SMA type)

Product name	01K1808-00 (Waka Manufacturing Co., Ltd.)
--------------	-------------------------------------------

Correction of insertion loss

The insertion loss of relay itself is given by subtracting the insertion loss of short-circuit the COM and the N.C. or N.O.

75 Ω

Measuring method

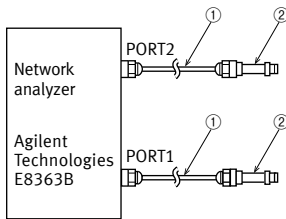

No.	Product name	Contents
1	85134-60003	Test port cable
2	11852B	Conversion adapter 50 Ω N type (female) - 75 Ω N type (male)
2	85039-60011	Conversion adapter 75 Ω N type (female) - 75 Ω F type (male)

- 1) Connect connectors 1 and 2 respectively to PORT1 and PORT2.
Perform calibration using the F type (75 Ω).
- 2) After calibration, connect the D.U.T board and measure.
However, connectors other than those for measurement should be connected with 75 Ω termination resistor.

● D.U.T board

Material	Glass PTFE double-sided through hole PC board R-4737 (manufactured by our company)
Board thickness	t = 0.8 mm
Copper plating thickness	18 μm

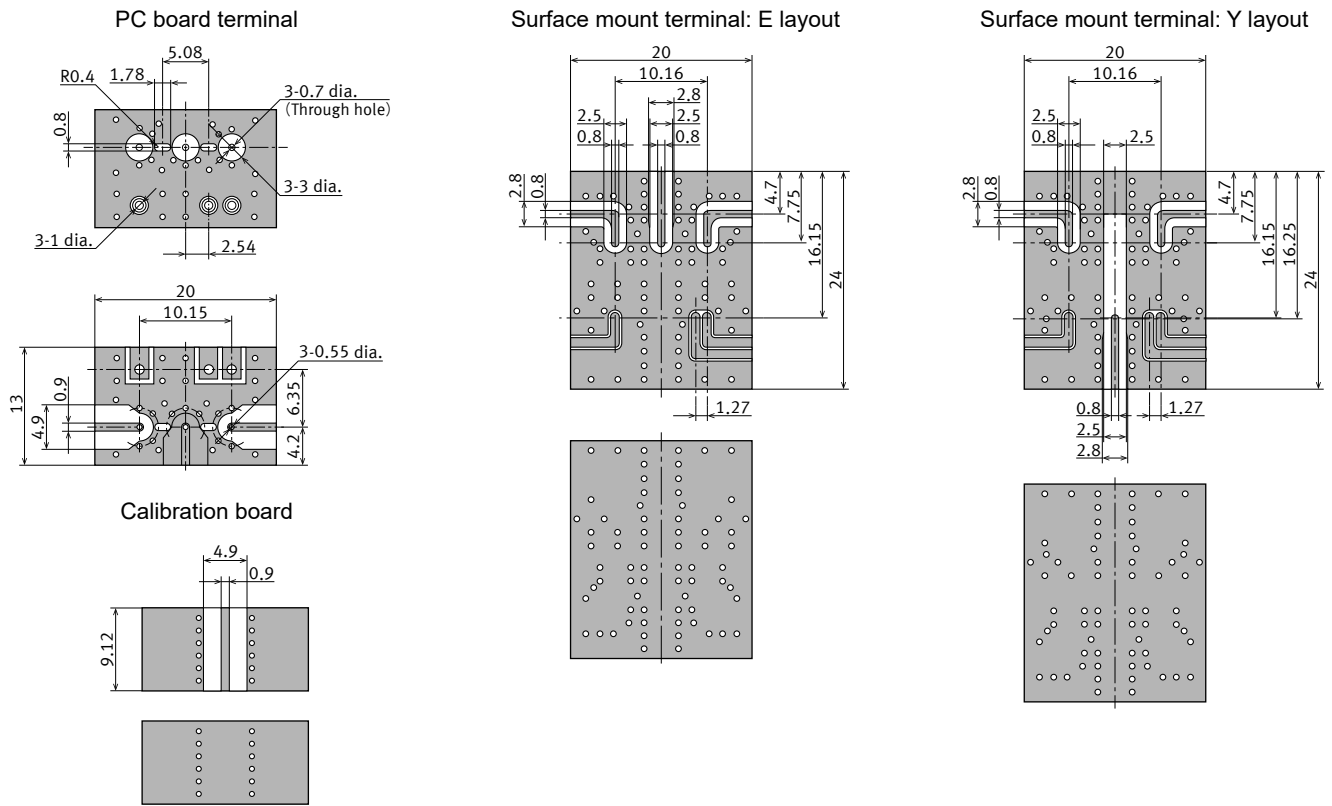

● Connector (F type Connector)

Product name	C05-0236 (Komine Musen Electric Corporation)
--------------	----------------------------------------------

● Correction of insertion loss

The insertion loss of relay itself is given by subtracting the insertion loss of short-circuit the COM and the N.C. or N.O.

DIMENSIONS

CAD The CAD data of the products with a "CAD" mark can be downloaded from our Website.

Unit: mm

■ PC board terminal

● 50 Ω

CAD

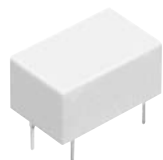

External dimensions

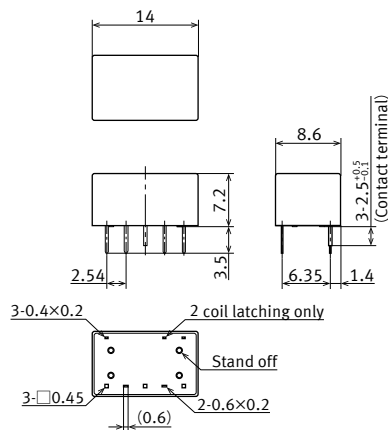

General tolerance : ±0.3

Recommended PC board pattern (BOTTOM VIEW)

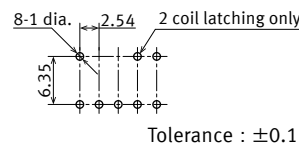

Microwave Devices RS RELAYS

● 75 Ω

CAD

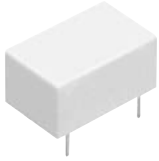

External dimensions

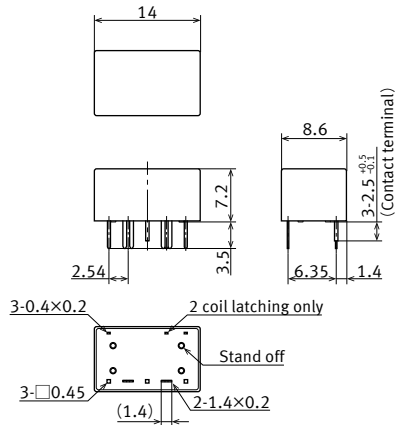

General tolerance : ±0.3

Recommended PC board pattern (BOTTOM VIEW)

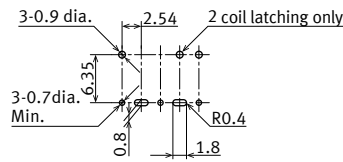

Tolerance : ±0.1

Schematic (BOTTOM VIEW)
Standard contact
Single side stable
(De-energize)

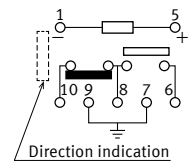

Reverse contact
Single side stable
(De-energize)

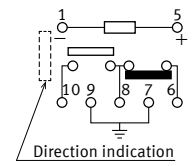

1 coil latching
(Reset)

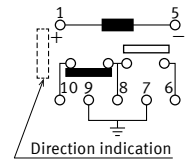

1 coil latching
(Reset)

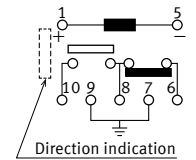

2 coil latching
(Reset)

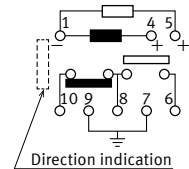

2 coil latching
(Reset)

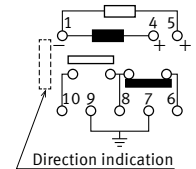

■ Surface mount terminal

● E layout: 50 Ω, 75 Ω

CAD



External dimensions

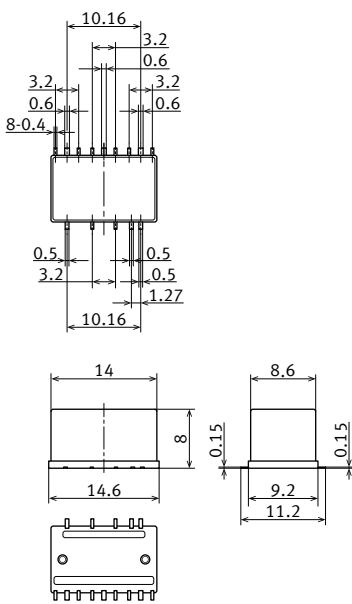

General tolerance : ±0.3

Recommended PC board pattern (TOP VIEW)

50 Ω

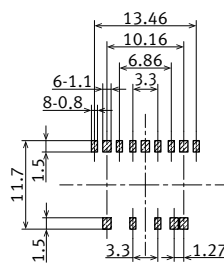

Tolerance : ±0.1

75 Ω

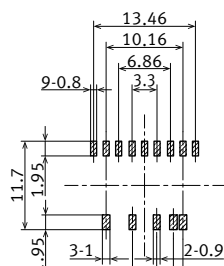

Tolerance : ±0.1

Schematic (TOP VIEW)

Standard contact
Single side stable
(De-energize)

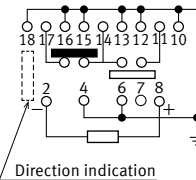

Reverse contact
Single side stable
(De-energize)

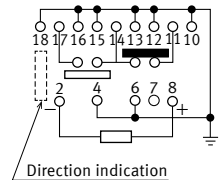

1 coil latching
(Reset)

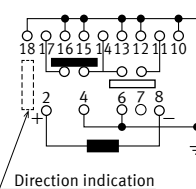

1 coil latching
(Reset)

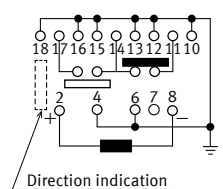

2 coil latching
(Reset)

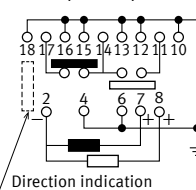

2 coil latching
(Reset)

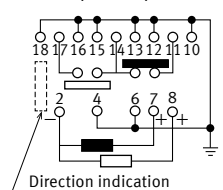

● Y layout: 50 Ω, 75 Ω

CAD



External dimensions

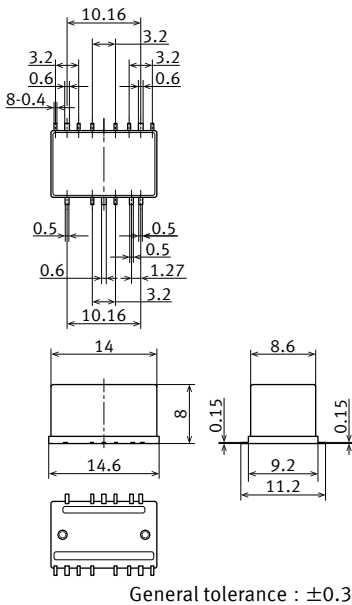

Recommended PC board pattern (TOP VIEW)

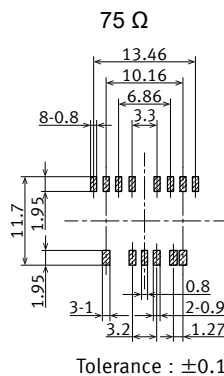
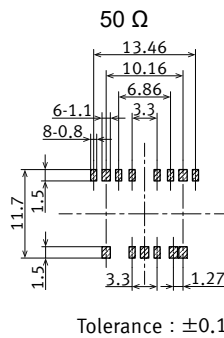

Schematic (TOP VIEW)
Standard contact
Single side stable
(De-energize)

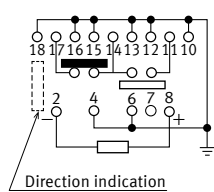

Reverse contact
Single side stable
(De-energize)

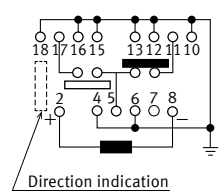

1 coil latching
(Reset)

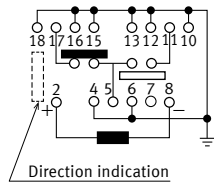

1 coil latching
(Reset)

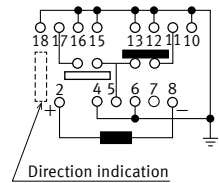

2 coil latching
(Reset)

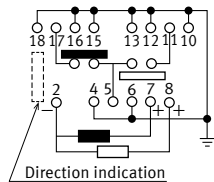

2 coil latching
(Reset)

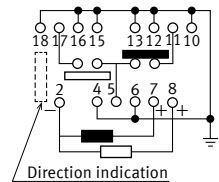

PACKING SPECIFICATION

Unit: mm

■ Tube packing

- 1) The relay is packed in a tube with the relay orientation mark on the left side, as shown in the figure.
- 2) Ambient temperature when transporting and during storage with the product in its our standard packaging:
-40 to +70 °C (Single side stable, standard type and latching)
-40 to +60 °C (Single side stable and quiet type)

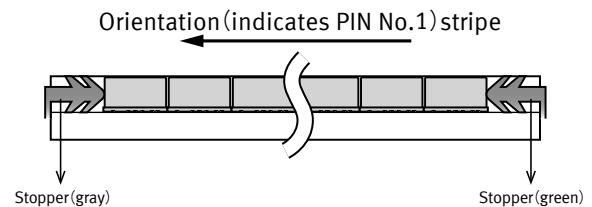

■ Tape and reel packing

1) Tape dimensions

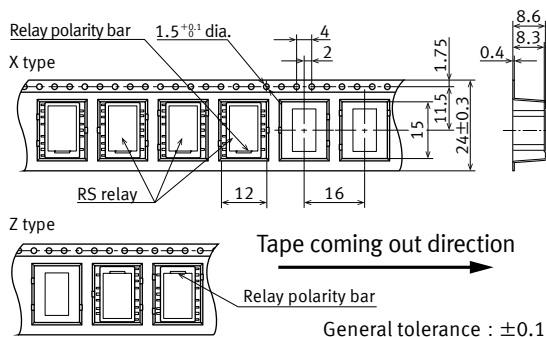

2) Dimensions of plastic reel

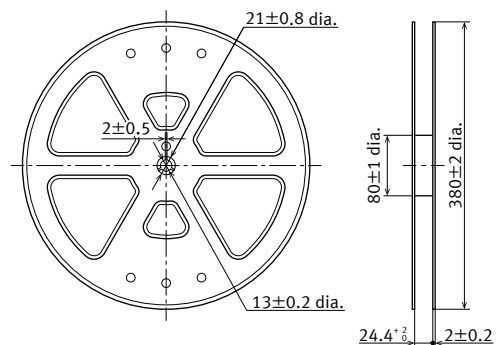

- 3) Ambient temperature when transporting and during storage with the product in its our standard packaging:
-40 to +70 °C (Single side stable, standard type and latching)
-40 to +60 °C (Single side stable and quiet type)

EXAMPLE FOR RECOMMENDED SOLDERING CONDITION

For cautions for use, please read “Relay Soldering and Cleaning Guidelines” and “SMT Soldering Guidelines”.

PC board terminal

In case of hand soldering, the following conditions should be observed.
The effect on the relay depends on the PC board used. Please verify the actual PC board to be used.

● Automatic soldering (Flow)

Recommended condition	Temperature	Time	Measurement area
Preheating	Max. 120 °C	Within 120 seconds	Solder surface terminal
Soldering	260 ± 5 °C	Within 6 seconds	Solder temperature

● Hand soldering

Recommended condition	Temperature	Time	Measurement area
Soldering	Max. 350 °C	Within 3 seconds	Tip temperature

Surface mount terminal

In case of automatic soldering (reflow), the following conditions should be observed.

● IRS (infrared reflow soldering method) heating conditions

Recommended condition	
The number of reflow operation	1 time
Measurement area	Surface of PC board where relay is mounted.

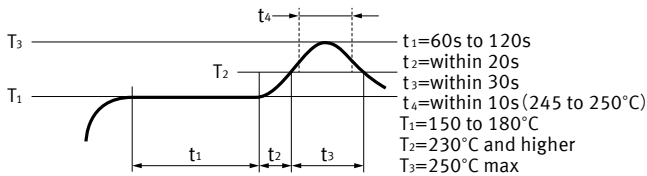

● Mounting cautions

Cautions to observe when mounting temperature increases in the relay are greatly dependent on the way different parts are located a PC board and the heating method of the reflow device. Therefore, please conduct testing on the actual device beforehand after making sure the parts soldered on the relay terminals and the top of the relay case are within the temperature conditions.

Measuring position of temperature profile

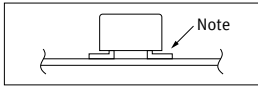

Note : The soldering temperature profile indicates the pad temperature. In some cases, the ambient temperature may be greatly increased. Check for the specific mounting condition.

Other things to observe

- Exceeding the stipulated conditions when soldering may affect coaxial switch performance. Be sure to consult us beforehand.
- Since thermal stress on a relay will depend on the PC board and process conditions, please be sure to test using the actual PC board.
- Creep-up, wettability and solder strength will differ depending on changes in the mounting conditions and type of solder. Please evaluate based on actual production conditions.
- Only apply coating after the relay has returned to room temperature.

GUIDELINES FOR USAGE

■ For cautions for use, please read “GUIDELINES FOR MICROWAVE DEVICES USAGE” and “GUIDELINES FOR RELAY USAGE”

■ Cautions for usage of RS relays

● Latching

- We recommend latching type when using in applications which involve lengthy duty cycles.
- Regarding the set and reset pulse time, for the purpose of reliable operation under ambient temperature fluctuations and different operating conditions, we recommend setting the coil applied set and reset pulse time to 30 ms or more at the rated coil voltage.
- The latching type relay is shipped in the reset position. But jolts during transport or impacts during installation can change the reset position. It is, therefore, advisable to build a circuit in which the relay can be initialized (set and reset) just after turning on the power.

● External magnetic field

- Since RS relays are highly sensitive polarized relays, their characteristics will be affected by a strong external magnetic field. Avoid using the relay under that condition.

CONDITIONS FOR USE

■ Conditions for use, transport and storage

During usage, storage, or transportation, avoid locations subject to direct sunlight and maintain normal temperature, humidity, and pressure conditions.

● Temperature and humidity

When transporting or storing relays while they are tube packaged, there are cases when the temperature may differ from the allowable range. In this situation, be sure to consult the individual specifications.

The humidity range varies with the temperature. Use within the range indicated in the graph. (The allowable temperature depends on the relays.)

Single side stable, Standard, Latching

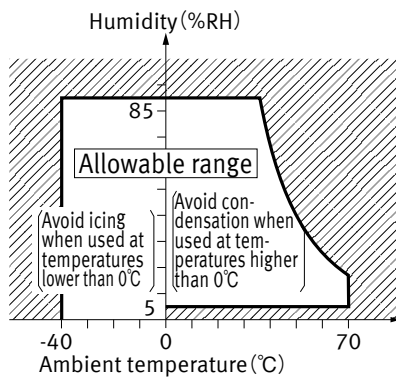

Single side stable, Quiet

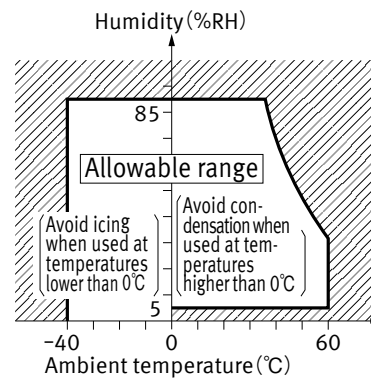

GUIDELINES FOR MICROWAVE DEVICES USAGE

For cautions for use, please read "GUIDELINES FOR RELAY USAGE".
https://industrial.panasonic.com/ac/e/control/relay/cautions_use/index.jsp

Precautions for Coil Input

■ Long term current carrying

A circuit that will be carrying a current continuously for long periods without relay or microwave device switching operation. (circuits for emergency lamps, alarm devices and error inspection that, for example, revert only during malfunction and output warnings with form B contacts) Continuous, long-term current to the coil will facilitate deterioration of coil insulation and characteristics due to heating of the coil itself.

For circuits such as these, please use a magnetic-hold type latching relay. If you need to use a single stable relay, use a sealed type relay that is not easily affected by ambient conditions and make a failsafe circuit design that considers the possibility of contact failure or disconnection.

■ DC Coil operating power

Steady state DC current should be applied to the coil. The wave form should be rectangular. If it includes ripple, the ripple factor should be less than 5%.

However, please check with the actual circuit since the electrical characteristics may vary. The rated coil voltage should be applied to the coil and the set/reset pulse time of latching type relay differs for each relays, please refer to the relay's individual specifications.

■ Coil connection

When connecting coils of polarized relays, please check coil polarity (+,-) at the internal connection diagram (Schematic). If any wrong connection is made, it may cause unexpected malfunction, like abnormal heat, fire and so on, and circuit do not work. Avoid impressing voltages to the set coil and reset coil at the same time.

■ Maximum allowable voltage and temperature rise

Proper usage requires that the rated coil voltage be impressed on the coil. Note, however, that if a voltage greater than or equal to the maximum continuous voltage is impressed on the coil, the coil may burn or its layers short due to the temperature rise. Furthermore, do not exceed the usable ambient temperature range listed in the catalog.

● Maximum allowable voltage for coil

In addition to being a requirement for relay operation stability, the maximum continuous impressed coil voltage is an important constraint for the prevention of such problems as thermal deterioration or deformity of the insulation material, or the occurrence of fire hazards.

Ambient Environment

● Dew condensation

Condensation occurs when the ambient temperature drops suddenly from a high temperature and humidity, or the relay and microwave device is suddenly transferred from a low ambient temperature to a high temperature and humidity. Condensation causes the failures like insulation deterioration, wire disconnection and rust etc.

Panasonic Corporation does not guarantee the failures caused by condensation.

The heat conduction by the equipment may accelerate the cooling of device itself, and the condensation may occur.

Please conduct product evaluations in the worst condition of the actual usage. (Special attention should be paid when high temperature heating parts are close to the device. Also please consider the condensation may occur inside of the device.)

● Icing

Condensation or other moisture may freeze on relays when the temperature become lower than 0 °C. This icing causes the sticking of movable portion, the operation delay and the contact conduction failure etc. Panasonic Corporation does not guarantee the failures caused by the icing.

The heat conduction by the equipment may accelerate the cooling of relay itself and the icing may occur. Please conduct product evaluations in the worst condition of the actual usage.

● Temperature rise due to pulse voltage

When a pulse voltage with ON time of less than 2 minutes is used, the coil temperature rise bears no relationship to the ON time. This varies with the ratio of ON time to OFF time, and compared with continuous current passage, it is rather small. The various relays are essentially the same in this respect.

Current passage time	(%)
For continuous passage	Temperature rise value is 100%
ON : OFF = 3 : 1	About 80%
ON : OFF = 1 : 1	About 50%
ON : OFF = 1 : 3	About 35%

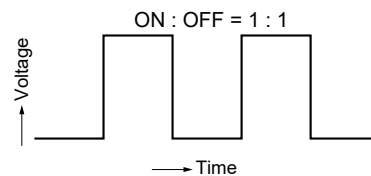

■ Operate voltage change due to coil temperature rise (Hot start)

In DC relays, after continuous passage of current in the coil, if the current is turned OFF, then immediately turned ON again, due to the temperature rise in the coil, the operate voltage will become somewhat higher. Also, it will be the same as using it in a higher temperature atmosphere. The resistance/temperature relationship for copper wire is about 0.4% for 1 °C, and with this ratio the coil resistance increases. That is, in order to operate of the relay, it is necessary that the voltage be higher than the operate voltage and the operate voltage rises in accordance with the increase in the resistance value. However, for some polarized relays, this rate of change is considerably smaller.

● Low temperature and low humidity

The plastic becomes brittle if the switch is exposed to a low temperature, low humidity environment for long periods of time.

● High temperature and high humidity

Storage for extended periods of time (including transportation periods) at high temperature or high humidity levels or in atmospheres with organic gases or sulfide gases may cause a sulfide film or oxide film to form on the surfaces of the contacts and/or it may interfere with the functions. Check out the atmosphere in which the units are to be stored and transported.

● Package

In terms of the packing format used, make every effort to keep the effects of moisture, organic gases and sulfide gases to the absolute minimum.

GUIDELINES FOR MICROWAVE DEVICES USAGE

●Storage requirements

Since the surface-mount terminal type is sensitive to humidity it is packaged with tightly sealed anti-humidity packaging. However, when storing, please be careful of the following.

1) Please use promptly once the anti-humidity pack is opened. (within 72 hours, Max. 30 °C/70% RH). If left with the pack open, the relay will absorb moisture which will cause thermal stress when reflow mounting and thus cause the case to expand. As a result, the seal may break.

*For RE relays, after this bag is opened, the product must be used within 24 hours.

2) If relays will not be used within 72 hours, please store relays in a humidity controlled desiccator or in an anti-humidity bag to which silica gel has been added.

*If the relay is to be soldered after it has been exposed to excessive humidity atmosphere, cracks and leaks can occur. Be sure to mount the relay under the required mounting conditions

*For RE relays, after this bag is opened, the product must be used within 24 hours.

3) The following cautionary label is affixed to the anti-humidity pack.

●Silicon

When a source of silicone substances (silicone rubber, silicone oil, silicone coating materials and silicone filling materials etc.) is used around the relay, the silicone gas (low molecular siloxane etc.) may be produced.

This silicone gas may penetrate into the inside of the relay. When the relay is kept and used in this condition, silicone compound may adhere to the relay contacts which may cause the contact failure. Do not use any sources of silicone gas around the relay (Including plastic seal types).

●NOx Generation

When relay is used in an atmosphere high in humidity to switch a load which easily produces an arc, the NOx created by the arc and the water absorbed from outside the relay combine to produce nitric acid.

This corrodes the internal metal parts and adversely affects operation. Avoid use at an ambient humidity of 85%RH or higher (at 20 °C). If use at high humidity is unavoidable, please contact our sales representative.

*RE Relays only

C a u t i o n

This vacuum-sealed bag contains

Moisture Sensitive Products

After this bag is opened, the product must be used

within 7 2 h o u r s

If product is not used within 72 hours, baking is necessary.

For baking conditions please contact us.

C a u t i o n

This vacuum-sealed bag contains

Moisture Sensitive Products

After this bag is opened, the product must be used

within 2 4 h o u r s

If product is not used within 24 hours, baking is necessary.

For baking conditions please contact us.

Others

■Cleaning

1) Although the environmentally sealed type relay (plastic sealed type, etc.) can be cleaned, avoid immersing the relay into cold liquid (such as cleaning solvent) immediately after soldering. Doing so may deteriorate the sealing performance.

2) Surface-mount terminal type relay is sealed type and it can be cleaned by immersion. Use pure water or alcohol-based cleaning solvent.

3) Cleaning with the boiling method is recommended (The temperature of cleaning liquid should be 40°C or lower).

Avoid ultrasonic cleaning on relays. Use of ultrasonic cleaning may cause breaks in the coil or slight sticking of the contacts due to the ultrasonic energy.

Please refer to "**the latest product specifications**" when designing your product.

•Requests to customers:

<https://industrial.panasonic.com/ac/e/salespolicies/>

Please contact

Panasonic Corporation

Electromechanical Control Business Division

■1006, Oaza Kadoma, Kadoma-shi, Osaka 571-8506, Japan
industrial.panasonic.com/ac/e/

Panasonic®

©Panasonic Corporation 2021

单击下面可查看定价，库存，交付和生命周期等信息

[>>Panasonic\(松下\)](#)