

TO :	文件编号	HXA-L43-20(01)
	发行日期	2019年10月20日

承 认 规 格 书

种 类 : SMD Power Choke Coil

系列号 : HXPC0618H-Series

客户料号 : _____

客 户 承 认 栏

客 户 承 认 栏	
承 认 日 期	年 月 日

(贵司承认后请签署一份返回华信安电子, 谢谢!)

厦 门 华 信 安 电 子 科 技 有 限 公 司 技 术 质 量 部

承 认	确 认	作 成
龙 梅	梁 峰	王 亮

TEL : 0592-6301603 FAX : 0592-5205265

Http : www.xmisnd.com

SMD Power Choke Coil

HXPC0618H-Series

ECN HISTORY LIST

REV	DATE	DESCRIPTION	APPROVED	CHECKED	DRAWN
1.0	19/10/20	新發行	龙梅	梁峰	王亮
備 注					

1. Features

1. Shielded construction.
2. Capable of corresponding high frequency .
3. Low loss realized with low DCR.
4. High performance (Isat) realized by metal dust core.
5. Ultra low buzz noise, due to composite construction.
6. 100% Lead(Pb)-Free and RoHS compliant.



2. Applications

1. DC/DC converters in distributed power systems.
2. DC/DC converter for Field Programmable Gate Array(FPGA).
3. Battery powered devices.
4. Thin type on-board power supply module for exchanger.
5. VRM for server.
6. High current, low profile POL converters.
7. PDA/notebook/desktop/server and battery powered devices.

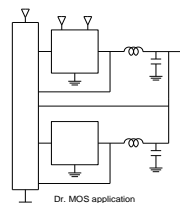

3. Dimensions

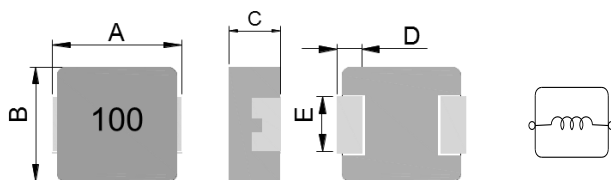

Recommend PC Board Pattern

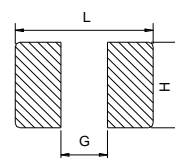

Series	A(mm)	B(mm)	C(mm)	D(mm)	E(mm)	F(mm)	L(mm)	G(mm)	H(mm)
HXPC0618H	7.0±0.3	6.6±0.2	1.6±0.2	1.6±0.3	3.0±0.3	0~-2.0	8.4	3.7	3.5

Note:側邊可 Coating0~-1.2 mm.

4. Part Numbering

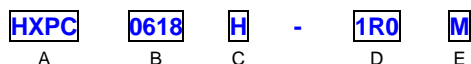

A: Series
 B: Dimension
 C: Type
 D: Inductance
 E: Inductance Tolerance

AxC
 Magnetic metal powder
 1R0=1.0uH
 M=±20%

5. Specification

ISND Part Number	Inductance L0 (uH)±20% @ 0 A	I rms (A) Typ.	I sat (A) Typ.	DCR(mΩ) Max.@25°C
HXPC0618H-R10M	0.10	25	38	2.3
HXPC0618H-R22M	0.22	22	24	3.5
HXPC0618H-R47M	0.47	11.5	18	8.4
HXPC0618H-R68M	0.68	9.5	16.5	12
HXPC0618H-1R0M	1.00	8.5	12	16
HXPC0618H-1R5M	1.50	8	9.2	26
HXPC0618H-2R2M	2.20	7	8	35
HXPC0618H-3R3M	3.30	4.5	6	50
HXPC0618H-4R7M	4.70	4	5	62
HXPC0618H-6R8M	6.80	3	4.5	110
HXPC0618H-100M	10.0	2.3	4	155
HXPC0618H-220M	22.0	1.8	2.3	350

Note:

1. Test frequency : L : 100KHz /1.0V;
2. All test data referenced to 25°C ambient.
3. Testing Instrument : L/Q: HP4284A,CH11025,CH3302,CH1320 ,CH1320S LCR METER / Rdc:CH16502,Agilent33420A MICRO OHMMETER.
4. Heat Rated Current (Irms) will cause the coil temperature rise approximately Δ t of 40°C (keep 1min.).
5. Saturation Current (Isat) will cause L0 to drop 30% typical. (keep quickly).
6. The part temperature (ambient + temp rise) should not exceed 125 °C under worst case operating conditions.Circuit design,component,PCB trace size and thickness,airflow and other cooling provisions all affect the part temperature. Pa

6. Material List

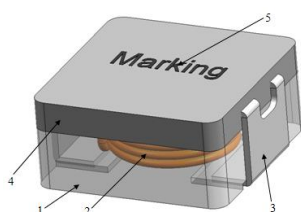

NO	Items	Materials
1	Core	Alloy Powder .
2	Wire	Polyester Wire or equivalent.
3	Solder Plating	100% Pb free solder
4	paint	Epoxy resin
5	Ink	Halogen-free ketone

7. Reliability and Test Condition

Item	Performance	Test Condition
Operating temperature	-40~+125°C	
Storage temperature and Humidity range	-40~+125°C,50~60%RH (Product without taping)	
Electrical Performance Test		
Inductance	Refer to standard electrical characteristics list.	HP4284A,CH11025,CH3302,CH1320,CH1320S LCR Meter.
DCR		CH16502,Agilent33420A Micro-Ohm Meter.
Saturation Current (Isat)	Δ L20% typical.	Saturation DC Current (Isat) will cause L0 to drop Δ L(%)(keep quickly).
Heat Rated Current (Irms)	Approximately Δ T≤ 40°C	Heat Rated Current (Irms) will cause the coil temperature rise Δ T(°C) without core loss. 1.Applied the allowed DC current(keep 1 min.). 2.Temperature measured by digital surface thermometer
Reliability Test		
High Temperature Exposure Test	Electric specifications should be satisfied	Temperature:125±2°C. Duration:1000±12hrs. Measured at room temperature after placing for 2 to 3hrs. (MIL-PRF-27)
Biased Humidity Test		Humidity:85±3%RH. Temperature:85±2°C. Duration:1000±12hrs. Measured at room temperature after placing for 2 to 3hrs (AEC-Q200-REV C)
Thermal shock test		Condition for 1 cycle Step1:-40+0 / -2°C 15±1 min. Step2:Room temperature within ≤ 0.2 min. Step3:+125+2 / -0°C 15±1min. Number of cycles:300 Measured at room temperature after placing for 2 to 3 hrs. (AEC-Q200-REV C)
Vibration test		Frequency: 10-2000-10Hz for 20 min. Amplitude: Parts mounted within 2" from any secure point. Directions and times: X, Y, Z directions for 20 min. This cycle shall be performed 12 times in each of three mutually perpendicular directions (Total 12hours). (MIL-STD-202 Method 204 D Test condition B)
Reflow test		Pre-heat : 150±5°C Duration : 5 minutes Temperature : 260±5°C , 20~40 seconds (IPC/JEDEC J-STD-020C)
Solder test		Terminals should be covered by over 95% solder on visual inspection

8. Soldering and Mounting

(1) Soldering

Mildly activated rosin fluxes are preferred. The minimum amount of solder can lead to damage from the stresses caused by the difference in coefficients of expansion between solder, chip and substrate. The terminations are suitable for re-flow soldering systems. If hand soldering cannot be avoided, the preferred technique is the utilization of hot air soldering tools.

(2) Solder re-flow:

Recommended temperature profiles for re-flow soldering in Figure 1.

(3) Soldering Iron:

Products attachment with a soldering iron is discouraged due to the inherent process control limitations. In the event that a soldering iron must be employed the following precautions are recommended.

- Preheat circuit and products to 150°C
- Never contact the ceramic with the iron tip
- Use a 20 watt soldering iron with tip diameter of 1.0mm
- 355°C tip temperature (max)
- 1.0mm tip diameter (max)
- Limit soldering time to 4-5sec.

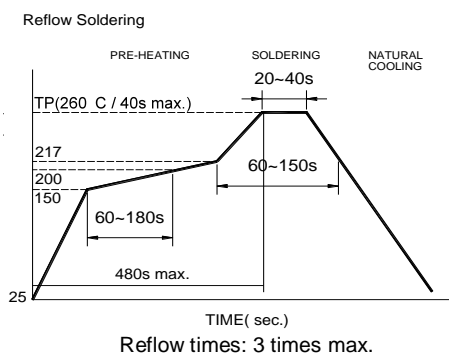

Fig.1

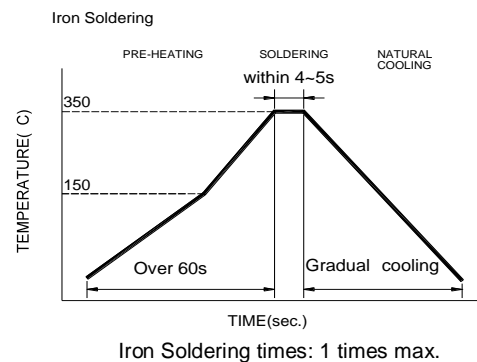
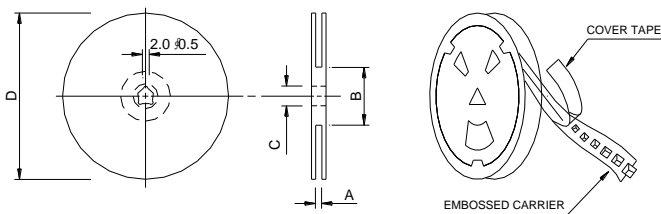

Fig.2

9. Packaging Information

(1) Reel Dimension



Type	A(mm)	B(mm)	C(mm)	D(mm)
13"x16mm	16.0±0.5	100±2	13.5±0.5	330

(2) Tape Dimension

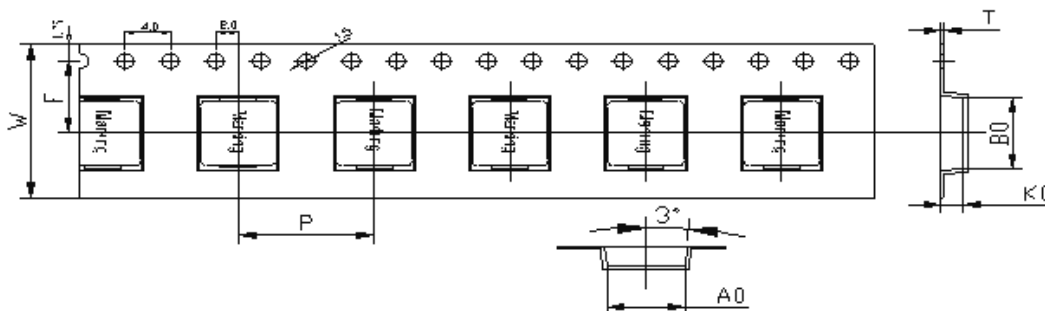

Series	Size	Bo(mm)	Ao(mm)	Ko(mm)	P(mm)	W(mm)	F(mm)	t(mm)
HXPC	0618	7.8±0.1	7.1±0.1	3.3±0.1	12.0±0.1	16±0.3	7.5±0.1	0.35±0.05

(3) Packaging Quantity

HXPC	0618
Chip / Reel	2000

(4) Tearing Off Force

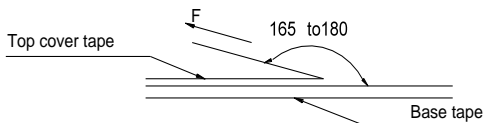

The force for tearing off cover tape is 10 to 130 grams in the arrow direction under the following conditions(referenced ANSI/EIA-481-C-2003 of 4.11 stadnard).

Room Temp. (°C)	Room Humidity (%)	Room atm (hPa)	Tearing Speed mm/min
5-35	45-85	860-1060	300

Application Notice

- Storage Conditions
 - To maintain the solderability of terminal electrodes:
 1. ISND products meet IPC/JEDEC J-STD-020D standard-MSL, level 1.
 2. Temperature and humidity conditions: Less than 30°C and 70% RH.
 3. Recommended products should be used within 6 months form the time of delivery.
 4. The packaging material should be kept where no chlorine or sulfur exists in the air.
- Transportation
 1. Products should be handled with care to avoid damage or contamination from perspiration and skin oils.
 2. The use of tweezers or vacuum pick up is strongly recommended for individual components.
 3. Bulk handling should ensure that abrasion and mechanical shock are minimized.

单击下面可查看定价，库存，交付和生命周期等信息

[>>ISND\(华信安\)](#)