

Isolated Current Sensor Current Sensor with 100 $\mu\Omega$ Current Conductor

Description

The SENKO SC780 is a fully integrated current sensor linear IC in a new core-less package designed to sense AC and DC currents up to 200 A. The Hall sensor technology also incorporates common-mode field rejection to optimize performance in the presence of interfering magnetic fields generated by nearby current-carrying conductors.

The device consists of a precision, low-offset linear Hall circuit with a copper conduction path located near the die. Applied current flowing through this copper conduction path generates a magnetic field which the Hall IC converts into a proportional voltage. Device accuracy is optimized through the close proximity of the primary conductor to the Hall transducer and factory programming of the sensitivity and quiescent output voltage at the SENKO factory.

Chopper-stabilized signal path and digital temperature compensation technology also contribute to the stability of the device across the operating temperature range.

The thickness of the copper conductor allows survival of the device at high over current conditions. The terminals of the conductive path are electrically isolated from the signal leads, allowing the device to operate safely with voltages up to 4.8KV peak on the primary conductor.

Package:

5-pin PF Type

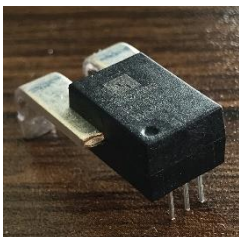

6-pin SF Type



Features

- Core-less, micro-size, 200A continuous current package
- Ultra-low power lost: 100 $\mu\Omega$ internal conductor resistance
- Immunity to common-mode field interference
- Greatly improved total output error through digitally programmed and compensated gain and offset over the full operating temperature range
- Industry-leading noise performance through proprietary amplifier and filter design techniques
- Integrated shield greatly reduces capacitive coupling from current conductor to die due to high dV/dt signals, and prevents offset drift in high-side, high-voltage applications
- Monolithic Hall IC for high reliability
- 4.5 to 5.5 V, single supply operation
- 120 kHz typical bandwidth
- 4.0 μs output rise time in response to step input current
- Output voltage proportional to AC or DC currents
- Factory-trimmed for accuracy
- Extremely stable quiescent output voltage

Typical Application

- Support 0 ~ $\pm 200\text{A}$, AC or DC

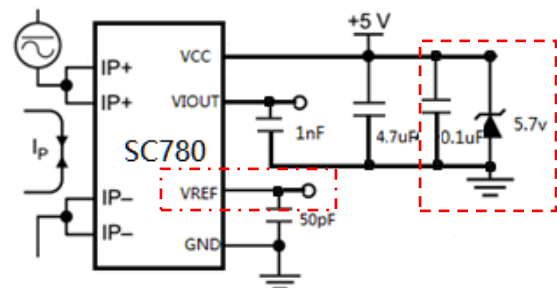

Note:

1. 4.7uF bypass is **MUST** have to guarantee performance;
2. VREF is **ONLY** available for 6-pin SF type package;
3. 0.1uF bypass capacitor is optional for VCC;
4. The Zenner or TVS diode is optional for protection purpose.

Order information

Part Number ⁽¹⁾	Sensed Current Direction	Primary Sampled Current, I _P (A)	Sensitivity Sens (Typ.) (mV/A)	T _{OP} (°C)	Packing ¹
SC780-050B-P	Bidirectional	±50	40	-40 to 150	P (PF)
SC780-050U-P	Unidirectional	50	80		
SC780-100B-P	Bidirectional	±100	20		
SC780-100U-P	Unidirectional	100	40		
SC780-150B-P	Bidirectional	±150	13.33	-40 to 125	
SC780-150U-P	Unidirectional	150	26.66		
SC780-200B-P	Bidirectional	±200	10	-40 to 85	
SC780-200U-P	Unidirectional	200	20		
SC780-025B-S	Bidirectional	±25	80	-40 to 150	S (SF)
SC780-040B-S	Bidirectional	±40	50		
SC780-050B-S	Bidirectional	±50	40		
SC780-080B-S	Bidirectional	±80	25		
SC780-100B-S	Bidirectional	±100	20	-40 to 125	
SC780-125B-S	Bidirectional	±125	16		

*Any custom requirement, email to fae@senkomicro.com

Mark Description

Logo	S	
Current Sensor	SC 780	Product Number
Package Type	P/SF 10	IP = xx * 10, unit: A
Silicon Version	BA 8F	Date Code

Functional Block Diagram

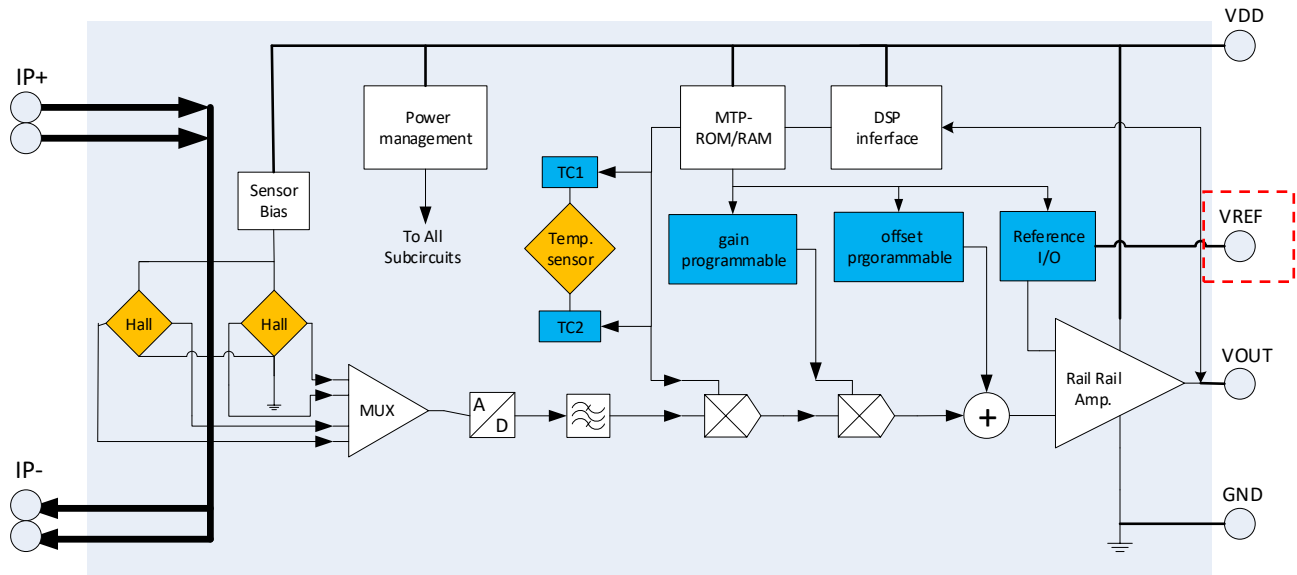

*Vref Pin only for SF package

Pin Configuration

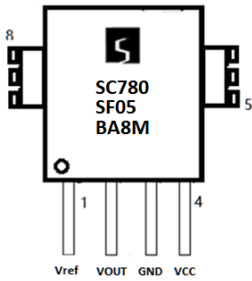

Number	Name	Description
5,6,7	IP-	Terminals for current being sampled; fused internally
8,9,10	IP+	Terminals for current being sampled; fused internally
3	GND	Signal Ground terminal
1	VREF	Reference voltage
2	VOUT	Analog output signal
4	VCC	Device power supply terminal

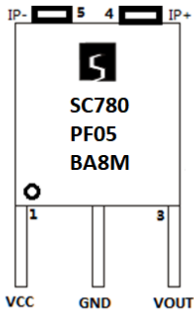

Number	Name	Description
4	IP+	Terminals for current being sampled; fused internally
5	IP-	Terminals for current being sampled; fused internally
2	GND	Signal Ground terminal
3	VOUT	Analog output signal
1	VCC	Device power supply terminal

Absolute Maximum Ratings

Absolute maximum ratings are limiting values to be applied individually, and beyond which the serviceability of the circuit may be impaired. Functional operability is not necessarily implied. Exposure to absolute maximum rating conditions for an extended period of time may affect device reliability.

Characteristic	Symbol	Notes	Rating	Unit
V_{CC}	Supply voltage		6.0	V
V_{RCC}	Reverse Supply Voltage		-0.1	V
V_{OUT}	Output voltage		6.0	V
V_{RIOUT}	Reverse Output Voltage		-0.1	V
V_{ISO}	Isolation Voltage	Pins 1-4 and 5-8; 60 Hz, 1 minute, $T_A=25^\circ\text{C}$	4800	VAC
		Maximum working voltage according to UL60950-1	990	V_{peak}
I_P	Overcurrent Transient Tolerance	1s duration, 1% duty cycle, room temp	1200	A
$I_{OUT(SOURCE)}$	Output Current Source		20	mA
$I_{OUT(SINK)}$	Output Current Sink		20	mA
T_A	Nominal Operating Ambient Temperature	Range F	-40~125	$^\circ\text{C}$
$T_{J(max)}$	Maximum Junction Temperature		165	$^\circ\text{C}$
T_{stg}	Storage Temperature		-65~170	$^\circ\text{C}$

Common operating Characteristics

Note: Over full range of $T_A=-40^\circ\text{C} \sim 125^\circ\text{C}$, $C_{bypass}=4.7\mu\text{f}$, $C_{load}=1.5\text{nF}$, $V_{CC}=5\text{V}$, unless otherwise specified.

Parameter	Symbol	Test Condition	Min	Typ	Max	Units
Supply Voltage	V_{CC}	Operating	4.5	5	5.5	V
Supply Current	I_{CC}	$V_{CC} = 5.0\text{V}$, output open		9	15	mA
Output Capacitance Load	C_{LOAD}	V_{IOUT} to GND		1.5	3	nF
Output Resistive Load	R_{LOAD}	V_{IOUT} to GND	0.17			k Ω
Primary Conductor Resistance	$R_{PRIMARY}$	$T_A = 25^\circ\text{C}$		0.1		m Ω
Rise Time	t_r	$I_P = I_P(max)$, $T_A = 25^\circ\text{C}$, $C_{OUT} = \text{open}$		4.0	5	μs
Frequency Bandwidth	f	-3 Db, $T_A=25^\circ\text{C}$; $I_P=10\text{A}$ peak-to-peak		120		kHz
Nonlinearity	E_{LIN}	Over full range of I_P		0.3	1	%
Symmetry	E_{SYM}	Over full range of I_P	99	100	101	%
Power-On Time	T_{PO}	Output reaches 90% of steady-state level, $T_J = 25^\circ\text{C}$, 20 A present		90		μs
Internal Filter Resistance	$R_{F(INT)}$			1.7		K Ω
Power supply bypass capacitor	C_{bypass}	Normal operating		4.7		μF
Vref capacitance load	C_{REF}			0	100	pF

Common Thermal Characteristics

Parameter	Symbol	Test Condition	Min	Typ	Max	Units
Operating Internal Lead Frame Temperature	T_A	F range	-40		125	$^\circ\text{C}$
Junction-to-Lead Thermal Resistance	$R_{\theta JL}$				5	$^\circ\text{C/W}$
Junction-to-Ambient Thermal Resistance	$R_{\theta JA}$				23	$^\circ\text{C/W}$

X-50B-P Individual Performance Characteristics

Note: TJ(max) is not exceeded TA=-40°C ~ 125°C, C_{Bypass}=4.7uF, C_{Load}=1.5nF, VCC=5V, unless otherwise specified

Parameter	Symbol	Test Conditions	Min	Typ	Max	Units
Optimized Accuracy Range	I _P		-50		50	A
V _{IOUT @ 0A}	V _{OQ}	I _P =0A, T _A =25°C		0.5V _{CC}		V
Sensitivity	Sens	Over full of T _A =25°C		40		mV/A
Zero Current Output Slope	ΔI _{OUT(Q)}	T _A = -40~25°C		±0.3		mV/°C
		T _A = 25~125°C		±0.25		mV/°C
Sensitivity Slope	ΔSens	T _A = -40~25°C		±0.007		mV/A/°C
		T _A = 25~125°C		-0.005		mV/A/°C
Total Output Error	E _{TOT}	I _P = 50 A, T _A =25°C, output filtered		±0.5		%
		I _P = 50 A, T _A =-40°C ~ 125°C, output filtered	-3		3	%

X-50U-P Individual Performance Characteristics

Note: TJ(max) is not exceeded TA=-40°C ~ 125°C, C_{Bypass}=4.7uF, C_{Load}=1.5nF, VCC=5V, unless otherwise specified

Parameter	Symbol	Test Conditions	Min	Typ	Max	Units
Optimized Accuracy Range	I _P		0		50	A
V _{IOUT @ 0A}	V _{OQ}	I _P =0A, T _A =25°C		0.1V _{CC}		V
Sensitivity	Sens	Over full of T _A =25°C		80		mV/A
Zero Current Output Slope	ΔI _{OUT(Q)}	T _A = -40~25°C		±0.3		mV/°C
		T _A = 25~125°C		±0.25		mV/°C
Sensitivity Slope	ΔSens	T _A = -40~25°C		±0.015		mV/A/°C
		T _A = 25~125°C		-0.01		mV/A/°C
Total Output Error	E _{TOT}	I _P = 50 A, T _A =25°C, output filtered		±0.5		%
		I _P = 50 A, T _A =-40°C ~ 125°C, output filtered	-3		3	%

X-100B-P Individual Performance Characteristics

Note: TJ(max) is not exceeded TA=-40°C ~ 125°C, C_{Bypass}=4.7uF, C_{Load}=1.5nF, VCC=5V, unless otherwise specified

Parameter	Symbol	Test Conditions	Min	Typ	Max	Units
Optimized Accuracy Range	I _P		-100		100	A
V _{IOUT @ 0A}	V _{OQ}	I _P =0A, T _A =25°C		0.5V _{CC}		V
Sensitivity	Sens	Over full of T _A =25°C		20		mV/A
Zero Current Output Slope	ΔI _{OUT(Q)}	T _A = -40~25°C		±0.3		mV/°C
		T _A = 25~125°C		±0.25		mV/°C
Sensitivity Slope	ΔSens	T _A = -40~25°C		±0.005		mV/A/°C
		T _A = 25~125°C		-0.003		mV/A/°C
Total Output Error	E _{TOT}	I _P = 100 A, T _A =25°C, output filtered		±0.5		%
		I _P = 100 A, T _A =-40°C ~ 125°C, output filtered	-2.5		2.5	%

X-100U-P Individual Performance Characteristics

Note: TJ(max) is not exceeded TA=-40°C ~ 125°C, C_{Bypass}=4.7uF, C_{Load}=1.5nF, VCC=5V, unless otherwise specified

Parameter	Symbol	Test Conditions	Min	Typ	Max	Units
Optimized Accuracy Range	I _P		0		100	A
V _{IOUT @ 0A}	V _{OQ}	I _P =0A, T _A =25°C		0.1V _{CC}		V
Sensitivity	Sens	Over full of T _A =25°C		40		mV/A
Zero Current Output Slope	ΔI _{OUT(Q)}	T _A = -40~25°C		±0.3		mV/°C
		T _A = 25~125°C		±0.25		mV/°C
Sensitivity Slope	ΔSens	T _A = -40~25°C		±0.007		mV/A/°C
		T _A = 25~125°C		-0.005		mV/A/°C
Total Output Error	E _{TOT}	I _P = 100 A, T _A =25°C, output filtered		±0.5		%
		I _P = 100 A, T _A =-40°C ~ 125°C, output filtered	-3		3	%

X-150B-P Individual Performance Characteristics

Note: $T_J(\max)$ is not exceeded $T_A = -40^\circ\text{C} \sim 125^\circ\text{C}$, $C_{\text{Bypass}} = 4.7\mu\text{F}$, $C_{\text{Load}} = 1.5\text{nF}$, $V_{\text{CC}} = 5\text{V}$, unless otherwise specified

Parameter	Symbol	Test Conditions	Min	Typ	Max	Units
Optimized Accuracy Range	I_P		-150		150	A
V _{IOUT} @ 0A	V_{OQ}	$I_P = 0\text{A}$, $T_A = 25^\circ\text{C}$		0.5V _{CC}		V
Sensitivity	Sens	Over full of $T_A = 25^\circ\text{C}$		13.33		mV/A
Zero Current Output Slope	$\Delta I_{\text{OUT}(Q)}$	$T_A = -40 \sim 25^\circ\text{C}$		± 0.3		mV/°C
		$T_A = 25 \sim 125^\circ\text{C}$		± 0.25		mV/°C
Sensitivity Slope	ΔSens	$T_A = -40 \sim 25^\circ\text{C}$		± 0.003		mV/A/°C
		$T_A = 25 \sim 125^\circ\text{C}$		-0.002		mV/A/°C
Total Output Error	E_{TOT}	$I_P = 150\text{A}$, $T_A = 25^\circ\text{C}$, output filtered		± 0.5		%
		$I_P = 150\text{A}$, $T_A = -40^\circ\text{C} \sim 125^\circ\text{C}$, output filtered	-2.5		2.5	%

X-150U-P Individual Performance Characteristics

Note: $T_J(\max)$ is not exceeded $T_A = -40^\circ\text{C} \sim 125^\circ\text{C}$, $C_{\text{Bypass}} = 4.7\mu\text{F}$, $C_{\text{Load}} = 1.5\text{nF}$, $V_{\text{CC}} = 5\text{V}$, unless otherwise specified

Parameter	Symbol	Test Conditions	Min	Typ	Max	Units
Optimized Accuracy Range	I_P		0		150	A
V _{IOUT} @ 0A	V_{OQ}	$I_P = 0\text{A}$, $T_A = 25^\circ\text{C}$		0.1V _{CC}		V
Sensitivity	Sens	Over full of $T_A = 25^\circ\text{C}$		26.66		mV/A
Zero Current Output Slope	$\Delta I_{\text{OUT}(Q)}$	$T_A = -40 \sim 25^\circ\text{C}$		± 0.3		mV/°C
		$T_A = 25 \sim 125^\circ\text{C}$		± 0.25		mV/°C
Sensitivity Slope	ΔSens	$T_A = -40 \sim 25^\circ\text{C}$		± 0.005		mV/A/°C
		$T_A = 25 \sim 125^\circ\text{C}$		-0.003		mV/A/°C
Total Output Error	E_{TOT}	$I_P = 150\text{A}$, $T_A = 25^\circ\text{C}$, output filtered		± 0.5		%
		$I_P = 150\text{A}$, $T_A = -40^\circ\text{C} \sim 125^\circ\text{C}$, output filtered	-2.5		2.5	%

X-200B-P Individual Performance Characteristics

Note: $T_J(\max)$ is not exceeded $T_A = -40^\circ\text{C} \sim 125^\circ\text{C}$, $C_{\text{Bypass}} = 4.7\mu\text{F}$, $C_{\text{Load}} = 1.5\text{nF}$, $V_{\text{CC}} = 5\text{V}$, unless otherwise specified

Parameter	Symbol	Test Conditions	Min	Typ	Max	Units
Optimized Accuracy Range	I_P		200		200	A
V _{IOUT} @ 0A	V_{OQ}	$I_P = 0\text{A}$, $T_A = 25^\circ\text{C}$		0.5V _{CC}		V
Sensitivity	Sens	Over full of $T_A = 25^\circ\text{C}$		10		mV/A
Zero Current Output Slope	$\Delta I_{\text{OUT}(Q)}$	$T_A = -40 \sim 25^\circ\text{C}$		± 0.27		mV/°C
		$T_A = 25 \sim 125^\circ\text{C}$		± 0.22		mV/°C
Sensitivity Slope	ΔSens	$T_A = -40 \sim 25^\circ\text{C}$		± 0.003		mV/A/°C
		$T_A = 25 \sim 125^\circ\text{C}$		-0.002		mV/A/°C
Total Output Error	E_{TOT}	$I_P = 200\text{A}$, $T_A = 25^\circ\text{C}$, output filtered		± 0.5		%
		$I_P = 200\text{A}$, $T_A = -40^\circ\text{C} \sim 125^\circ\text{C}$, output filtered	-2.5		2.5	%

X-200U-P Individual Performance Characteristics

Note: $T_J(\max)$ is not exceeded $T_A = -40^\circ\text{C} \sim 125^\circ\text{C}$, $C_{\text{Bypass}} = 4.7\mu\text{F}$, $C_{\text{Load}} = 1.5\text{nF}$, $V_{\text{CC}} = 5\text{V}$, unless otherwise specified

Parameter	Symbol	Test Conditions	Min	Typ	Max	Units
Optimized Accuracy Range	I_P		0		200	A
V _{IOUT} @ 0A	V_{OQ}	$I_P = 0\text{A}$, $T_A = 25^\circ\text{C}$		0.1V _{CC}		V
Sensitivity	Sens	Over full of $T_A = 25^\circ\text{C}$		20		mV/A
Zero Current Output Slope	$\Delta I_{\text{OUT}(Q)}$	$T_A = -40 \sim 25^\circ\text{C}$		± 0.3		mV/°C
		$T_A = 25 \sim 125^\circ\text{C}$		± 0.25		mV/°C
Sensitivity Slope	ΔSens	$T_A = -40 \sim 25^\circ\text{C}$		± 0.005		mV/A/°C
		$T_A = 25 \sim 125^\circ\text{C}$		-0.003		mV/A/°C
Total Output Error	E_{TOT}	$I_P = 200\text{A}$, $T_A = 25^\circ\text{C}$, output filtered		± 0.5		%
		$I_P = 200\text{A}$, $T_A = -40^\circ\text{C} \sim 125^\circ\text{C}$, output filtered	-2.5		2.5	%

X-25B-S Individual Performance Characteristics

Note: $T_J(\max)$ is not exceeded $T_A = -40^\circ\text{C} \sim 125^\circ\text{C}$, $C_{\text{Bypass}} = 4.7\mu\text{F}$, $C_{\text{Load}} = 1.5\text{nF}$, $V_{\text{CC}} = 5\text{V}$, unless otherwise specified

Parameter	Symbol	Test Conditions	Min	Typ	Max	Units
Optimized Accuracy Range	I_P		-25		25	A
V _{IOUT @ 0A}	V_{OQ}	$I_P = 0\text{A}$, $T_A = 25^\circ\text{C}$		2.5		V
Sensitivity	Sens	Over full of $T_A = 25^\circ\text{C}$		80		mV/A
Zero Current Output Slope	$\Delta I_{\text{OUT}(Q)}$	$T_A = -40 \sim 25^\circ\text{C}$		± 0.34		mV/°C
		$T_A = 25 \sim 125^\circ\text{C}$		± 0.25		mV/°C
Sensitivity Slope	ΔSens	$T_A = -40 \sim 25^\circ\text{C}$		± 0.023		mV/A/°C
		$T_A = 25 \sim 125^\circ\text{C}$		-0.03		mV/A/°C
Total Output Error	E_{TOT}	$I_P = 25\text{A}$, $T_A = 25^\circ\text{C}$, output filtered		± 0.5		%
		$I_P = 25\text{A}$, $T_A = -40^\circ\text{C} \sim 125^\circ\text{C}$, output filtered	-3		3	%

X-40B-S Individual Performance Characteristics

Note: $T_J(\max)$ is not exceeded $T_A = -40^\circ\text{C} \sim 125^\circ\text{C}$, $C_{\text{Bypass}} = 4.7\mu\text{F}$, $C_{\text{Load}} = 1.5\text{nF}$, $V_{\text{CC}} = 5\text{V}$, unless otherwise specified

Parameter	Symbol	Test Conditions	Min	Typ	Max	Units
Optimized Accuracy Range	I_P		-40		40	A
V _{IOUT @ 0A}	V_{OQ}	$I_P = 0\text{A}$, $T_A = 25^\circ\text{C}$		2.5		V
Sensitivity	Sens	Over full of $T_A = 25^\circ\text{C}$		50		mV/A
Zero Current Output Slope	$\Delta I_{\text{OUT}(Q)}$	$T_A = -40 \sim 25^\circ\text{C}$		± 0.3		mV/°C
		$T_A = 25 \sim 125^\circ\text{C}$		± 0.25		mV/°C
Sensitivity Slope	ΔSens	$T_A = -40 \sim 25^\circ\text{C}$		± 0.007		mV/A/°C
		$T_A = 25 \sim 125^\circ\text{C}$		-0.005		mV/A/°C
Total Output Error	E_{TOT}	$I_P = 40\text{A}$, $T_A = 25^\circ\text{C}$, output filtered		± 0.5		%
		$I_P = 40\text{A}$, $T_A = -40^\circ\text{C} \sim 125^\circ\text{C}$, output filtered	-3		3	%

X-50B-S Individual Performance Characteristics

Note: $T_J(\max)$ is not exceeded $T_A = -40^\circ\text{C} \sim 125^\circ\text{C}$, $C_{\text{Bypass}} = 4.7\mu\text{F}$, $C_{\text{Load}} = 1.5\text{nF}$, $V_{\text{CC}} = 5\text{V}$, unless otherwise specified

Parameter	Symbol	Test Conditions	Min	Typ	Max	Units
Optimized Accuracy Range	I_P		-50		50	A
V _{IOUT @ 0A}	V_{OQ}	$I_P = 0\text{A}$, $T_A = 25^\circ\text{C}$		2.5		V
Sensitivity	Sens	Over full of $T_A = 25^\circ\text{C}$		40		mV/A
Zero Current Output Slope	$\Delta I_{\text{OUT}(Q)}$	$T_A = -40 \sim 25^\circ\text{C}$		± 0.3		mV/°C
		$T_A = 25 \sim 125^\circ\text{C}$		± 0.25		mV/°C
Sensitivity Slope	ΔSens	$T_A = -40 \sim 25^\circ\text{C}$		± 0.007		mV/A/°C
		$T_A = 25 \sim 125^\circ\text{C}$		-0.005		mV/A/°C
Total Output Error	E_{TOT}	$I_P = 50\text{A}$, $T_A = 25^\circ\text{C}$, output filtered		± 0.5		%
		$I_P = 50\text{A}$, $T_A = -40^\circ\text{C} \sim 125^\circ\text{C}$, output filtered	-3		3	%

X-80B-S Individual Performance Characteristics

Note: $T_J(\max)$ is not exceeded $T_A = -40^\circ\text{C} \sim 125^\circ\text{C}$, $C_{\text{Bypass}} = 4.7\mu\text{F}$, $C_{\text{Load}} = 1.5\text{nF}$, $V_{\text{CC}} = 5\text{V}$, unless otherwise specified

Parameter	Symbol	Test Conditions	Min	Typ	Max	Units
Optimized Accuracy Range	I_P		-80		80	A
V _{IOUT @ 0A}	V_{OQ}	$I_P = 0\text{A}$, $T_A = 25^\circ\text{C}$		2.5		V
Sensitivity	Sens	Over full of $T_A = 25^\circ\text{C}$		25		mV/A
Zero Current Output Slope	$\Delta I_{\text{OUT}(Q)}$	$T_A = -40 \sim 25^\circ\text{C}$		± 0.3		mV/°C
		$T_A = 25 \sim 125^\circ\text{C}$		± 0.25		mV/°C
Sensitivity Slope	ΔSens	$T_A = -40 \sim 25^\circ\text{C}$		± 0.005		mV/A/°C
		$T_A = 25 \sim 125^\circ\text{C}$		-0.003		mV/A/°C
Total Output Error	E_{TOT}	$I_P = 80\text{A}$, $T_A = 25^\circ\text{C}$, output filtered		± 0.5		%
		$I_P = 80\text{A}$, $T_A = -40^\circ\text{C} \sim 125^\circ\text{C}$, output filtered	-2.5		2.5	%

X-100B-S Individual Performance Characteristics

Note: $T_J(\max)$ is not exceeded $T_A = -40^\circ\text{C} \sim 125^\circ\text{C}$, $C_{\text{Bypass}} = 4.7\mu\text{F}$, $C_{\text{Load}} = 1.5\text{nF}$, $V_{\text{CC}} = 5\text{V}$, unless otherwise specified

Parameter	Symbol	Test Conditions	Min	Typ	Max	Units
Optimized Accuracy Range	I_P		-100		100	A
V _{IOUT} @ 0A	V_{OQ}	$I_P = 0\text{A}$, $T_A = 25^\circ\text{C}$		2.5		V
Sensitivity	Sens	Over full of $T_A = 25^\circ\text{C}$		20		mV/A
Zero Current Output Slope	$\Delta I_{\text{OUT}(Q)}$	$T_A = -40 \sim 25^\circ\text{C}$		± 0.3		mV/ $^\circ\text{C}$
		$T_A = 25 \sim 125^\circ\text{C}$		± 0.25		mV/ $^\circ\text{C}$
Sensitivity Slope	ΔSens	$T_A = -40 \sim 25^\circ\text{C}$		± 0.005		mV/A/ $^\circ\text{C}$
		$T_A = 25 \sim 125^\circ\text{C}$		-0.003		mV/A/ $^\circ\text{C}$
Total Output Error	E_{TOT}	$I_P = 100\text{A}$, $T_A = 25^\circ\text{C}$, output filtered		± 0.5		%
		$I_P = 100\text{A}$, $T_A = -40^\circ\text{C} \sim 125^\circ\text{C}$, output filtered	-2.5		2.5	%

X-125B-S Individual Performance Characteristics

Note: $T_J(\max)$ is not exceeded $T_A = -40^\circ\text{C} \sim 125^\circ\text{C}$, $C_{\text{Bypass}} = 4.7\mu\text{F}$, $C_{\text{Load}} = 1.5\text{nF}$, $V_{\text{CC}} = 5\text{V}$, unless otherwise specified

Parameter	Symbol	Test Conditions	Min	Typ	Max	Units
Optimized Accuracy Range	I_P		-125		125	A
V _{IOUT} @ 0A	V_{OQ}	$I_P = 0\text{A}$, $T_A = 25^\circ\text{C}$		2.5		V
Sensitivity	Sens	Over full of $T_A = 25^\circ\text{C}$		16		mV/A
Zero Current Output Slope	$\Delta I_{\text{OUT}(Q)}$	$T_A = -40 \sim 25^\circ\text{C}$		± 0.3		mV/ $^\circ\text{C}$
		$T_A = 25 \sim 125^\circ\text{C}$		± 0.25		mV/ $^\circ\text{C}$
Sensitivity Slope	ΔSens	$T_A = -40 \sim 25^\circ\text{C}$		± 0.004		mV/A/ $^\circ\text{C}$
		$T_A = 25 \sim 125^\circ\text{C}$		-0.003		mV/A/ $^\circ\text{C}$
Total Output Error	E_{TOT}	$I_P = 125\text{A}$, $T_A = 25^\circ\text{C}$, output filtered		± 0.5		%
		$I_P = 125\text{A}$, $T_A = -40^\circ\text{C} \sim 125^\circ\text{C}$, output filtered	-2.5		2.5	%

Typical Performance Graphs

Note: Over full range of $T_A = -40^{\circ}\text{C} \sim 125^{\circ}\text{C}$, $C_{\text{Bypass}} = 4.7\mu\text{f}$, $C_{\text{Load}} = 1.5\text{nF}$, $V_{\text{CC}} = 5\text{V}$, $I_P = 50\text{A}$, unless otherwise specified.

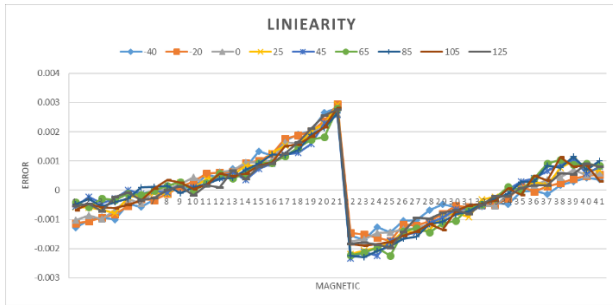

Figure 1. Linearity versus Ambient Temperature

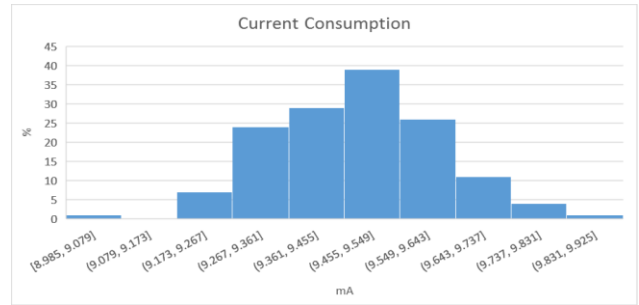

Figure 2. Current Consumption

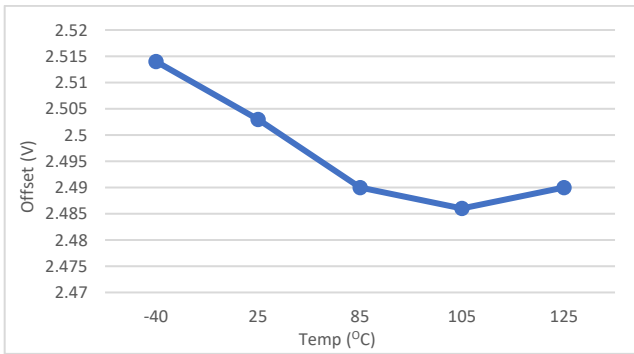

Figure 3. Zero Current Output versus Ambient Temperature

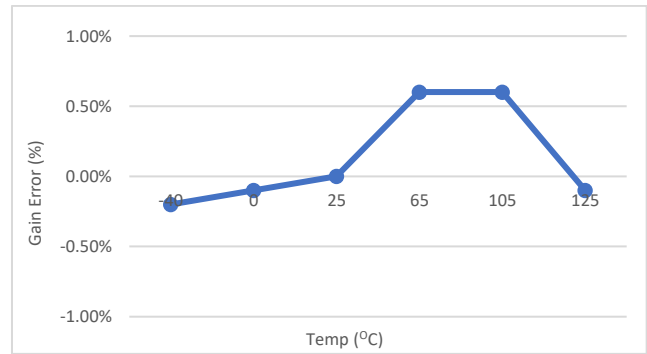

Figure 4. Sensitivity Error versus Ambient Temperature

Dynamic Performance

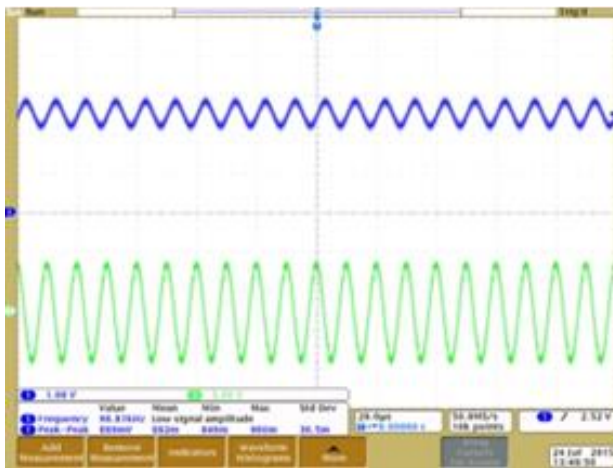

Figure 5. 100k 25A IP Frequency Response.

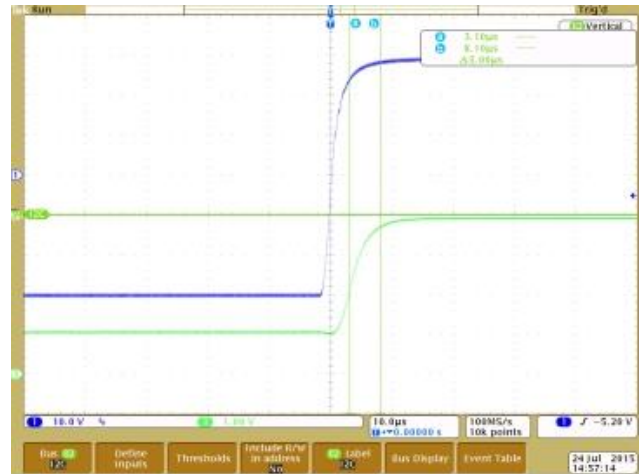
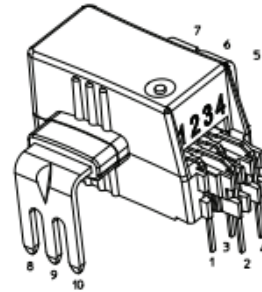
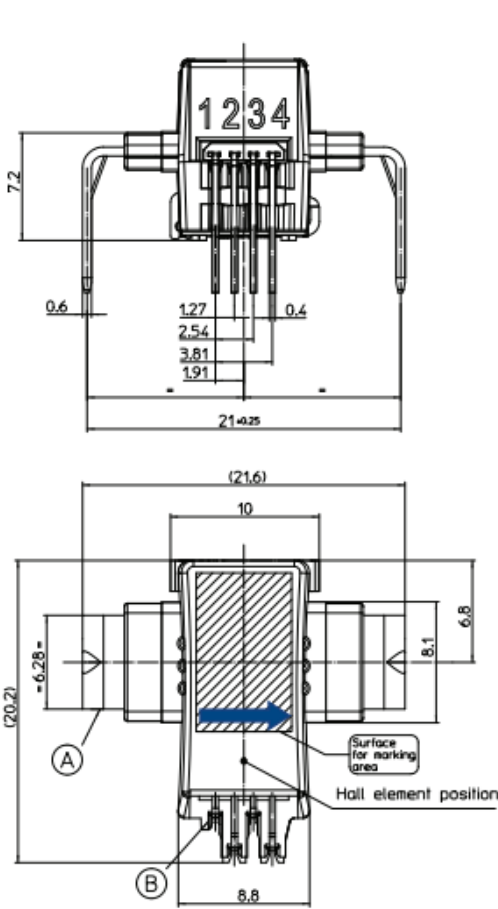

Figure 6. < 5uS Response Time

Package Information

6-pin SF Package, all dimensions are in millimeters.



5-pin PF Package, all dimensions are in millimeters.

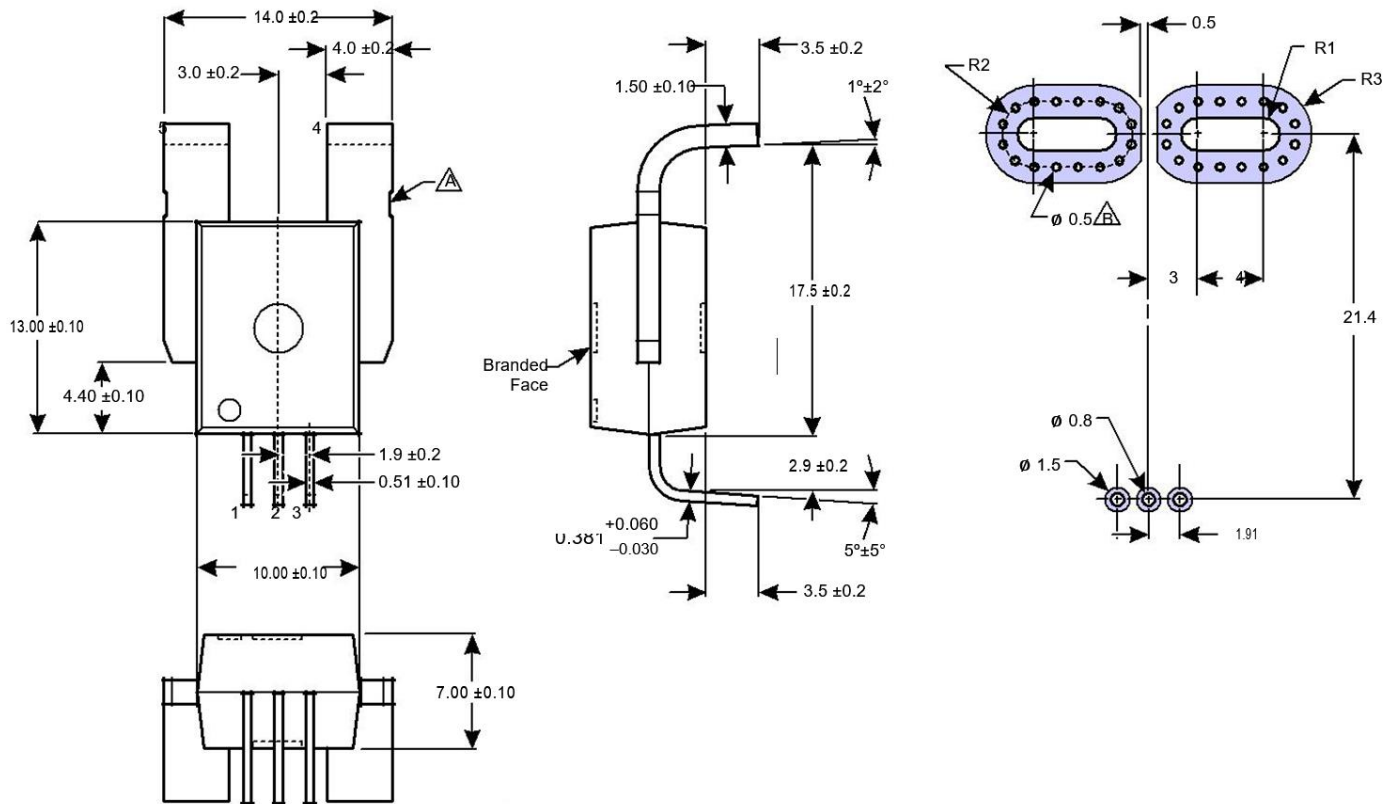

Important Notice

SENKO micro-electronics co., Ltd. reserves the right to make, from time to time, such departures from the detail specifications as may be required to permit improvements in the performance, reliability, or manufacturability of its products. Before placing an order, the user is cautioned to verify that the information being relied upon is current.

SENKO micro's products are not to be used in life support devices or systems, if a failure of an SENKO product can reasonably be expected to cause the failure of that life support device or system, or to affect the safety or effectiveness of that device or system.

The information included herein is believed to be accurate and reliable. However, SENKO micro-electronics co., Ltd. assumes no responsibility for its use; nor for any infringement of patents or other rights of third parties which may result from its use.

For the latest version of this document, visit our website: www.senkomicro.com

Revision Table

Revision	Change	Page	Author	Date
1.0	Initial draft		Jon	2016.03
1.1	Add unipolar IP detect mode		Jon	2017.02
1.4	Change SC780-xxxx-S current		Hao	2017.11
1.5	Change format		Hao	2018.03
1.6	Change chart of parameters		Hao	2018.04

单击下面可查看定价，库存，交付和生命周期等信息

[>>Senko Micro\(兴工微\)](#)