

### GENERAL DESCRIPTION

The SGM2033 is an ultra-low noise, low  $V_{IN}$ , high PSRR, high accuracy and low dropout voltage linear regulator which is designed using CMOS technology. It provides 250mA output current capability. The operating input voltage range is from 1.8V to 5.5V and output voltage range is from 1.2V to 5.0V.

Other features include logic-controlled shutdown mode, short-circuit current limit and thermal shutdown protection. The SGM2033 has automatic discharge function to quickly discharge  $V_{OUT}$  in the disabled status.

The SGM2033 is suitable for application which needs low noise and fast transient response power supply, such as power supply of camera module in smart phone, etc.

The SGM2033 is available in Green SOT-23-5 and UTDFN-1×1-4AL packages. It operates over an operating temperature range of -40°C to +125°C.

### APPLICATIONS

- Portable Electronic Devices
- Smoke Detectors
- Battery-Powered Equipment
- Smartphones and Tablets
- Digital Cameras and Audio Devices

### TYPICAL APPLICATION

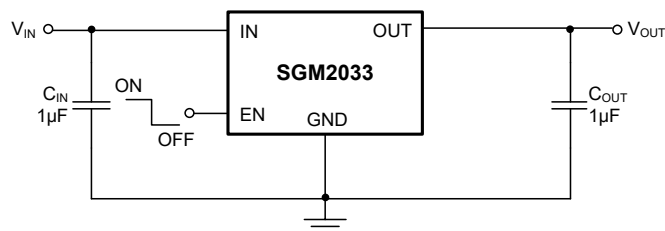

Fixed Voltage Typical Application Circuit

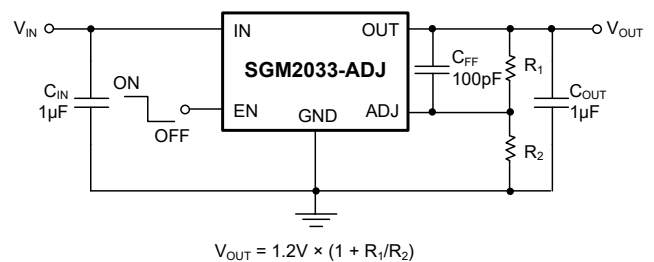

Adjustable Voltage Typical Application Circuit

Figure 1. Typical Application Circuits

### FEATURES

- Operating Input Voltage Range: 1.8V to 5.5V
- Fixed Output Voltage Range: 1.2V to 5.0V
- Adjustable Output Voltage Range: 1.2V to 5.0V
- Output Current Limit: 500mA (TYP)
- Ultra-Low Quiescent Current: 13.5µA (TYP)
- Shutdown Current: 0.1µA (TYP)
- High PSRR: 94dB (TYP) at 1kHz
- Low Dropout Voltage:
  - ♦ 175mV (TYP) at 250mA when  $V_{OUT} = 1.8V$  (SOT-23-5)
  - ♦ 145mV (TYP) at 250mA when  $V_{OUT} = 1.8V$  (UTDFN-1×1-4AL)
- Output Short-Circuit Protection
- Thermal Shutdown Protection
- Fast Load Transient Response
- Stable with 1µF Small Case Size Ceramic Capacitors
- -40°C to +125°C Operating Temperature Range
- Available in Green SOT-23-5 and UTDFN-1×1-4AL Packages

## PACKAGE/ORDERING INFORMATION

MODEL	PACKAGE DESCRIPTION	SPECIFIED TEMPERATURE RANGE	ORDERING NUMBER	PACKAGE MARKING	PACKING OPTION
SGM2033-1.2	SOT-23-5	-40°C to +125°C	SGM2033-1.2XN5G/TR	GP1XX	Tape and Reel, 3000
SGM2033-1.8	SOT-23-5	-40°C to +125°C	SGM2033-1.8XN5G/TR	GTFXX	Tape and Reel, 3000
SGM2033-2.5	SOT-23-5	-40°C to +125°C	SGM2033-2.5XN5G/TR	GU0XX	Tape and Reel, 3000
SGM2033-2.8	SOT-23-5	-40°C to +125°C	SGM2033-2.8XN5G/TR	GU1XX	Tape and Reel, 3000
SGM2033-2.85	SOT-23-5	-40°C to +125°C	SGM2033-2.85XN5G/TR	GU2XX	Tape and Reel, 3000
SGM2033-2.9	SOT-23-5	-40°C to +125°C	SGM2033-2.9XN5G/TR	GU3XX	Tape and Reel, 3000
SGM2033-2.95	SOT-23-5	-40°C to +125°C	SGM2033-2.95XN5G/TR	GU4XX	Tape and Reel, 3000
SGM2033-3.0	SOT-23-5	-40°C to +125°C	SGM2033-3.0XN5G/TR	GU5XX	Tape and Reel, 3000
SGM2033-3.3	SOT-23-5	-40°C to +125°C	SGM2033-3.3XN5G/TR	GU6XX	Tape and Reel, 3000
SGM2033-4.2	SOT-23-5	-40°C to +125°C	SGM2033-4.2XN5G/TR	GP5XX	Tape and Reel, 3000
SGM2033-5.0	SOT-23-5	-40°C to +125°C	SGM2033-5.0XN5G/TR	GU7XX	Tape and Reel, 3000
SGM2033-ADJ	SOT-23-5	-40°C to +125°C	SGM2033-ADJXN5G/TR	CHAXX	Tape and Reel, 3000
SGM2033-1.2	UTDFN-1×1-4AL	-40°C to +125°C	SGM2033-1.2XUDH4G/TR	63X	Tape and Reel, 10000
SGM2033-1.8	UTDFN-1×1-4AL	-40°C to +125°C	SGM2033-1.8XUDH4G/TR	U8X	Tape and Reel, 10000
SGM2033-2.5	UTDFN-1×1-4AL	-40°C to +125°C	SGM2033-2.5XUDH4G/TR	U9X	Tape and Reel, 10000
SGM2033-2.8	UTDFN-1×1-4AL	-40°C to +125°C	SGM2033-2.8XUDH4G/TR	UAX	Tape and Reel, 10000
SGM2033-2.85	UTDFN-1×1-4AL	-40°C to +125°C	SGM2033-2.85XUDH4G/TR	UBX	Tape and Reel, 10000
SGM2033-2.9	UTDFN-1×1-4AL	-40°C to +125°C	SGM2033-2.9XUDH4G/TR	UCX	Tape and Reel, 10000
SGM2033-2.95	UTDFN-1×1-4AL	-40°C to +125°C	SGM2033-2.95XUDH4G/TR	UDX	Tape and Reel, 10000
SGM2033-3.0	UTDFN-1×1-4AL	-40°C to +125°C	SGM2033-3.0XUDH4G/TR	UEX	Tape and Reel, 10000
SGM2033-3.3	UTDFN-1×1-4AL	-40°C to +125°C	SGM2033-3.3XUDH4G/TR	UFX	Tape and Reel, 10000
SGM2033-4.2	UTDFN-1×1-4AL	-40°C to +125°C	SGM2033-4.2XUDH4G/TR	61X	Tape and Reel, 10000
SGM2033-5.0	UTDFN-1×1-4AL	-40°C to +125°C	SGM2033-5.0XUDH4G/TR	V0X	Tape and Reel, 10000

## MARKING INFORMATION

NOTE: XX = Date Code. X = Date Code.

## SOT-23-5

YYY X X

Date Code - Week  
Date Code - Year  
Serial Number

## UTDFN-1×1-4AL

YY X

Date Code - Quarter  
Serial Number

Green (RoHS & HSF): SG Micro Corp defines "Green" to mean Pb-Free (RoHS compatible) and free of halogen substances. If you have additional comments or questions, please contact your SGMICRO representative directly.

**ABSOLUTE MAXIMUM RATINGS**

IN, EN to GND .....	-0.3V to 6V
OUT, ADJ to GND .....	-0.3V to ( $V_{IN} + 0.3V$ )
Package Thermal Resistance	
SOT-23-5, $\theta_{JA}$ .....	207°C/W
UTDFN-1×1-4AL, $\theta_{JA}$ .....	238°C/W
Junction Temperature .....	+150°C
Storage Temperature Range .....	-65°C to +150°C
Lead Temperature (Soldering, 10s) .....	+260°C
ESD Susceptibility	
HBM .....	8000V
MM .....	400V
CDM .....	1000V

**RECOMMENDED OPERATING CONDITIONS**

Input Voltage Range .....	1.8V to 5.5V
Enable Input Voltage Range .....	0V to 5.5V
Input Effective Capacitance, $C_{IN}$ .....	0.1µF (MIN)
Output Effective Capacitance, $C_{OUT}$ .....	0.5µF to 10µF
Operating Junction Temperature Range .....	-40°C to +125°C

**OVERSTRESS CAUTION**

Stresses beyond those listed in Absolute Maximum Ratings may cause permanent damage to the device. Exposure to absolute maximum rating conditions for extended periods may affect reliability. Functional operation of the device at any conditions beyond those indicated in the Recommended Operating Conditions section is not implied.

**ESD SENSITIVITY CAUTION**

This integrated circuit can be damaged if ESD protections are not considered carefully. SGMICRO recommends that all integrated circuits be handled with appropriate precautions. Failure to observe proper handling and installation procedures can cause damage. ESD damage can range from subtle performance degradation to complete device failure. Precision integrated circuits may be more susceptible to damage because even small parametric changes could cause the device not to meet the published specifications.

**DISCLAIMER**

SG Micro Corp reserves the right to make any change in circuit design, or specifications without prior notice.

PIN CONFIGURATIONS

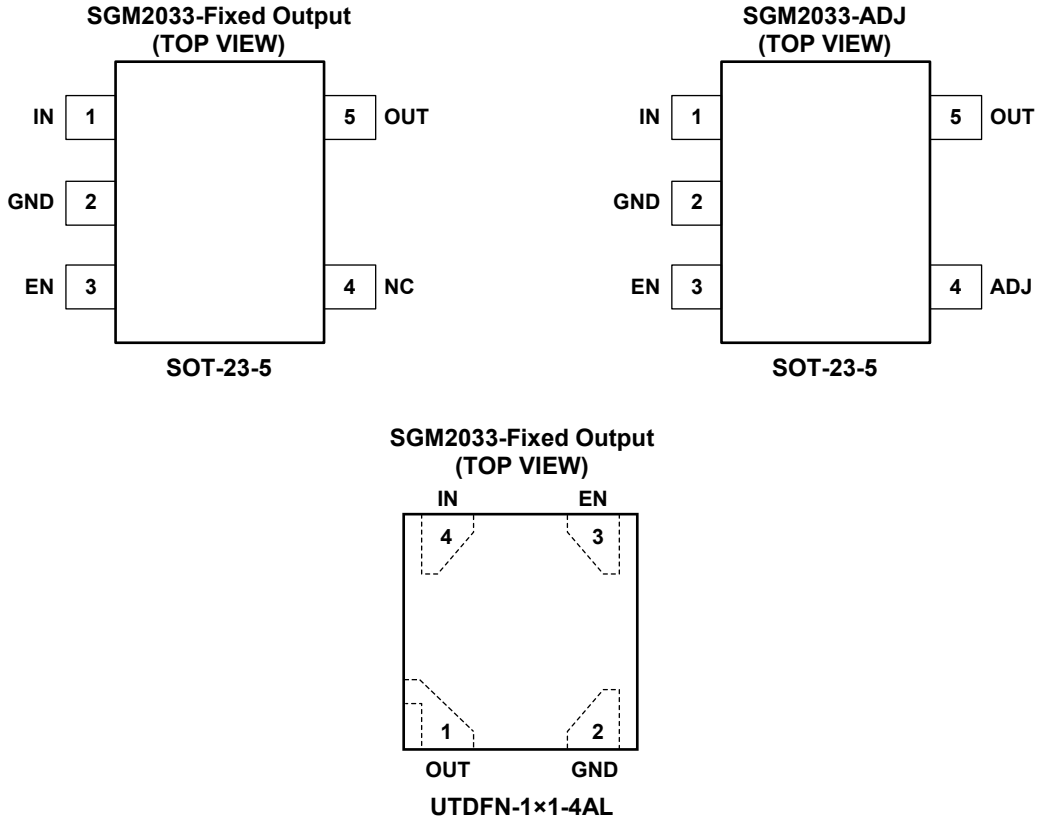

PIN DESCRIPTION

PIN		NAME	FUNCTION
SOT-23-5	UTDFN-1x1-4AL		
1	4	IN	Input Voltage Supply Pin.
2	2	GND	Ground.
3	3	EN	Enable Pin. Drive EN high to turn on the regulator. Drive EN low to turn off the regulator. The EN pin has an internal 0.2µA pull-down current source which ensures that the device is turned off when the EN pin is floated. This pin must be connected to IN pin if enable functionality is not used.
4	-	NC	Not Connected (fixed voltage version only).
		ADJ	Feedback Input Pin (adjustable voltage version only). Connect this pin to the external resistor divider to adjust the output voltage. Place the resistors as close as possible to this pin.
5	1	OUT	Regulated Output Pin. It is recommended to use an output capacitor with effective capacitance in the range of 0.5µF to 10µF. The capacitor should be located very close to this pin.

## ELECTRICAL CHARACTERISTICS

( $V_{IN} = V_{OUT(NOM)} + 1.0V$ ,  $I_{OUT} = 0.1mA$ ,  $V_{EN} = V_{IN}$ ,  $C_{IN} = C_{OUT} = 1\mu F$ ,  $T_J = -40^\circ C$  to  $+125^\circ C$ , typical values are at  $T_J = +25^\circ C$ , unless otherwise noted.)

PARAMETER	SYMBOL	CONDITIONS		TEMP	MIN	TYP	MAX	UNITS
Operating Input Voltage Range	$V_{IN}$			$-40^\circ C$ to $+125^\circ C$	1.8		5.5	V
Feedback Voltage	$V_{FB}$	SGM2033-ADJ		$+25^\circ C$	1.188	1.2	1.212	V
				$-40^\circ C$ to $+125^\circ C$	1.182		1.218	
Output Voltage Accuracy	$V_{OUT}$	$V_{IN} = (V_{OUT(NOM)} + 1.0V)$ to 5.5V		$+25^\circ C$	-1		+1	%
				$-40^\circ C$ to $+125^\circ C$	-1.5		+1.5	
Line Regulation	$\frac{\Delta V_{OUT}}{\Delta V_{IN} \times V_{OUT}}$	$V_{IN} = (V_{OUT(NOM)} + 1.0V)$ to 5.5V		$V_{OUT(NOM)} \leq 3.3V$	$-40^\circ C$ to $+125^\circ C$	0.01	0.12	%V
				$V_{OUT(NOM)} = 4.2V$	$-40^\circ C$ to $+125^\circ C$	0.04	0.36	
Load Regulation	$\Delta V_{OUT}$	$I_{OUT} = 0.1mA$ to 250mA		$V_{OUT(NOM)} \leq 1.8V$	$+25^\circ C$	3		mV
				$V_{OUT(NOM)} > 1.8V$	$+25^\circ C$	7		
Dropout Voltage <sup>(1)</sup>	$V_{DROPO}$	$I_{OUT} = 250mA$ , SOT-23-5		$1.8V \leq V_{OUT(NOM)} < 2.8V$	$-40^\circ C$ to $+125^\circ C$	175	265	mV
				$2.8V \leq V_{OUT(NOM)} < 3.3V$	$-40^\circ C$ to $+125^\circ C$	120	200	
				$3.3V \leq V_{OUT(NOM)} < 4.2V$	$-40^\circ C$ to $+125^\circ C$	105	180	
				$4.2V \leq V_{OUT(NOM)} \leq 5.0V$	$-40^\circ C$ to $+125^\circ C$	95	155	
Dropout Voltage <sup>(1)</sup>	$V_{DROPO}$	$I_{OUT} = 250mA$ , UTDFN-1x1-4AL		$1.8V \leq V_{OUT(NOM)} < 2.8V$	$-40^\circ C$ to $+125^\circ C$	145	225	mV
				$2.8V \leq V_{OUT(NOM)} < 3.3V$	$-40^\circ C$ to $+125^\circ C$	85	145	
				$3.3V \leq V_{OUT(NOM)} < 4.2V$	$-40^\circ C$ to $+125^\circ C$	72	125	
				$4.2V \leq V_{OUT(NOM)} \leq 5.0V$	$-40^\circ C$ to $+125^\circ C$	62	110	
Output Current Limit <sup>(2)</sup>	$I_{LIM}$			$+25^\circ C$	260	500		mA
Short Circuit Current	$I_{SC}$	$V_{OUT} = 0V$		$+25^\circ C$		220		mA
Quiescent Current	$I_Q$	No load		$-40^\circ C$ to $+125^\circ C$		13.5	22	$\mu A$
Shutdown Current	$I_{SHDN}$	$V_{EN} = 0V$ , $V_{IN} = 5.5V$		$+25^\circ C$		0.1	1	$\mu A$
				$-40^\circ C$ to $+125^\circ C$			2.5	
Feedback Current	$I_{FB}$	$V_{ADJ} = 1.3V$		$+25^\circ C$		1		nA
EN Pin Threshold Voltage	$V_{IH}$	EN input voltage high		$-40^\circ C$ to $+125^\circ C$	1.5			V
	$V_{IL}$	EN input voltage low		$-40^\circ C$ to $+125^\circ C$			0.4	
EN Pull-Down Current	$I_{EN}$	$V_{EN} = 5.5V$		$-40^\circ C$ to $+125^\circ C$		0.2	1	$\mu A$
Turn-On Time	$t_{ON}$	From assertion of $V_{EN}$ to $V_{OUT} = 90\% V_{OUT(NOM)}$		$+25^\circ C$		120		$\mu s$
Power Supply Rejection Ratio	PSRR	$I_{OUT} = 20mA$		$f = 100Hz$	$+25^\circ C$	84		dB
				$f = 1kHz$	$+25^\circ C$	94		
				$f = 10kHz$	$+25^\circ C$	73		
				$f = 100kHz$	$+25^\circ C$	33		
Output Voltage Noise	$e_n$	$f = 10Hz$ to $100kHz$ $V_{OUT} = 2.8V$		$I_{OUT} = 1mA$	$+25^\circ C$	26		$\mu V_{RMS}$
				$I_{OUT} = 250mA$	$+25^\circ C$	20		
Output Discharge Resistance	$R_{DISCH}$	$V_{EN} \leq 0.4V$ , $V_{IN} = 5.0V$		$+25^\circ C$		220		$\Omega$
Thermal Shutdown Temperature	$T_{SHDN}$					165		$^\circ C$
Thermal Shutdown Hysteresis	$\Delta T_{SHDN}$					20		$^\circ C$

### NOTES:

- The dropout voltage is defined as the difference between  $V_{IN}$  and  $V_{OUT}$  when  $V_{OUT}$  falls to  $95\% \times V_{OUT(NOM)}$ .
- Output current limit is characterized when  $V_{OUT}$  falls 200mV below  $V_{OUT(NOM)}$ .

TYPICAL PERFORMANCE CHARACTERISTICS

$T_J = +25^\circ\text{C}$ ,  $V_{IN} = V_{OUT(NOM)} + 1.0\text{V}$ ,  $V_{EN} = V_{IN}$ ,  $C_{IN} = C_{OUT} = 1\mu\text{F}$ , unless otherwise noted.

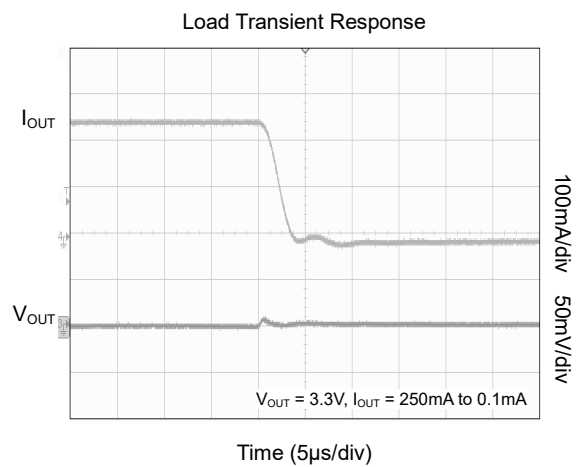
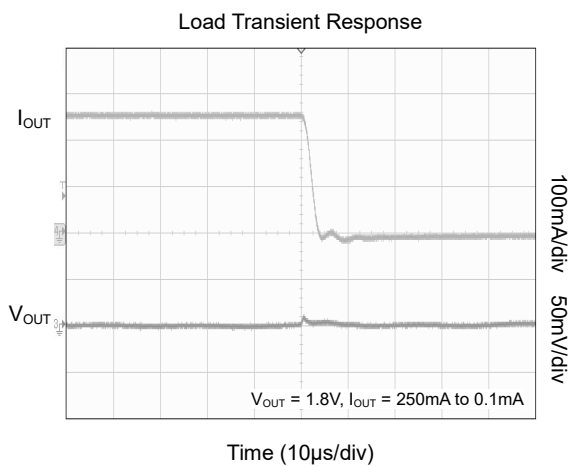
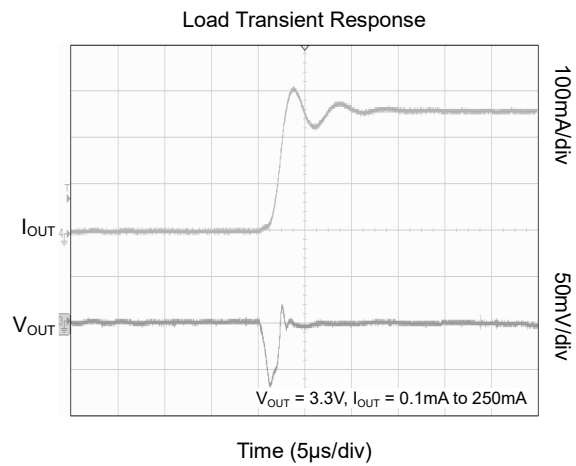
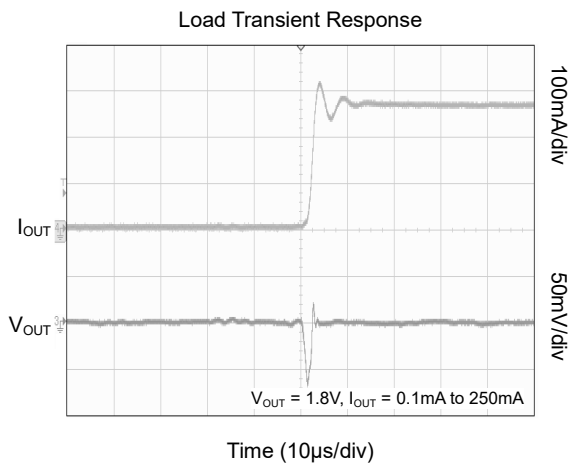
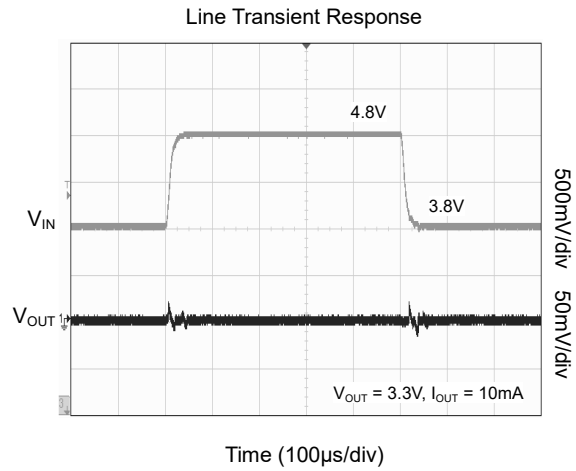
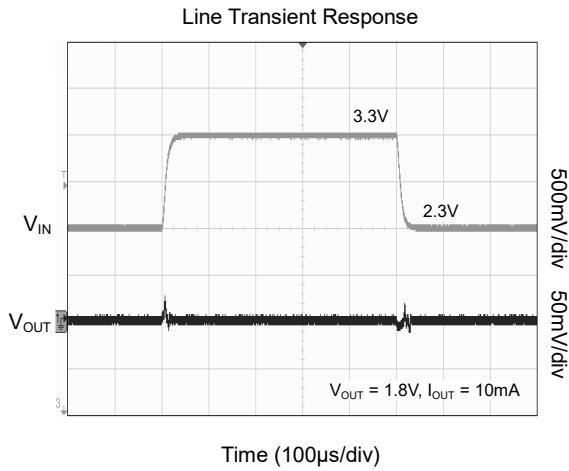

TYPICAL PERFORMANCE CHARACTERISTICS (continued)

$T_J = +25^\circ\text{C}$ ,  $V_{IN} = V_{OUT(NOM)} + 1.0\text{V}$ ,  $V_{EN} = V_{IN}$ ,  $C_{IN} = C_{OUT} = 1\mu\text{F}$ , unless otherwise noted.

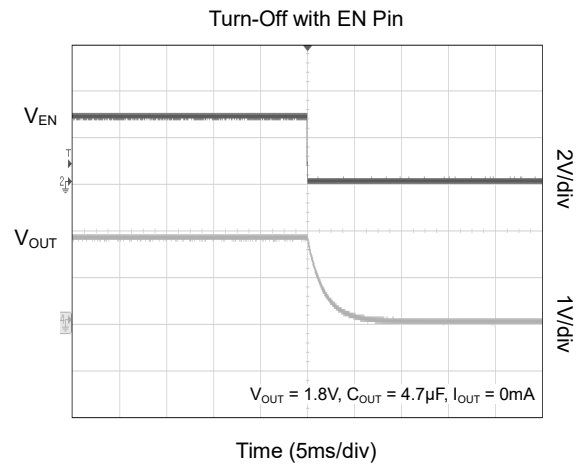
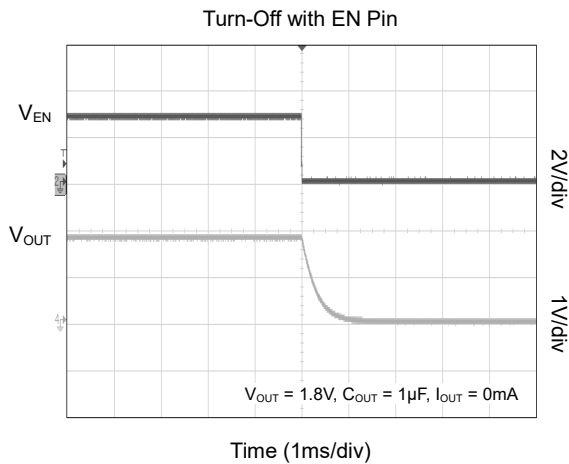
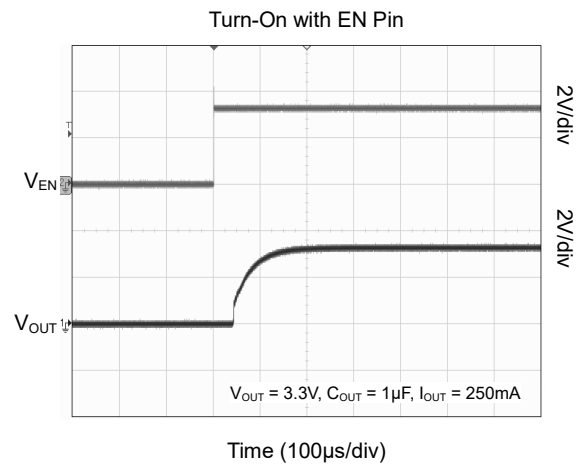
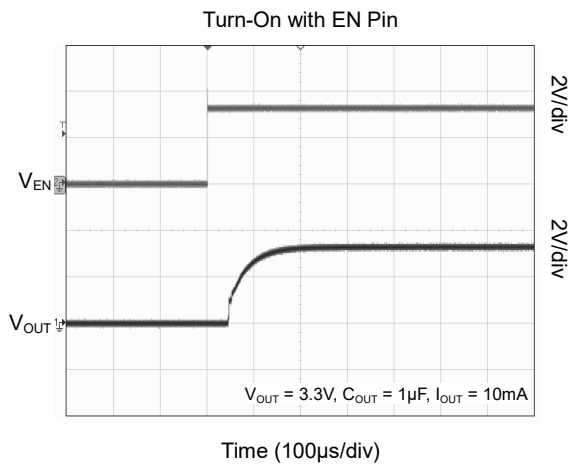
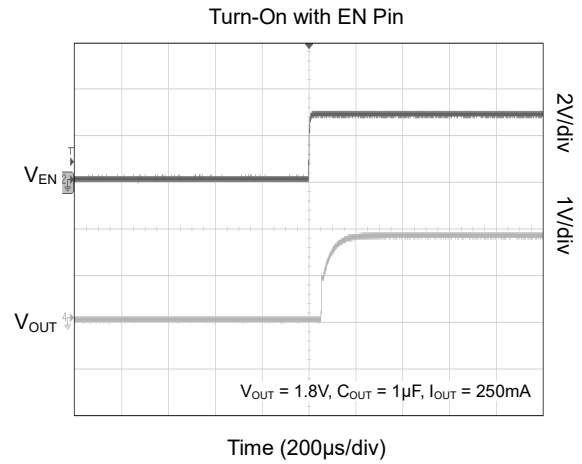
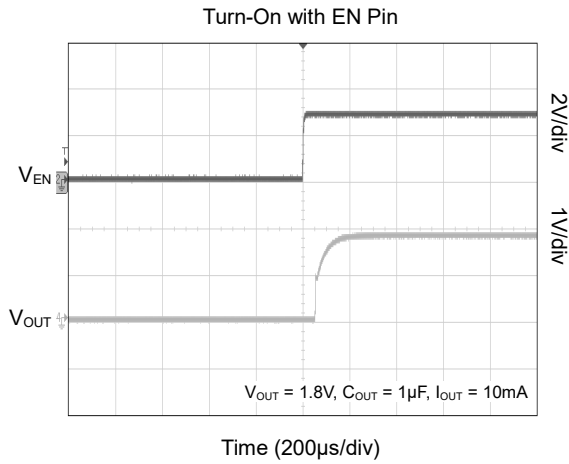

TYPICAL PERFORMANCE CHARACTERISTICS (continued)

$T_J = +25^\circ\text{C}$ ,  $V_{IN} = V_{OUT(NOM)} + 1.0\text{V}$ ,  $V_{EN} = V_{IN}$ ,  $C_{IN} = C_{OUT} = 1\mu\text{F}$ , unless otherwise noted.

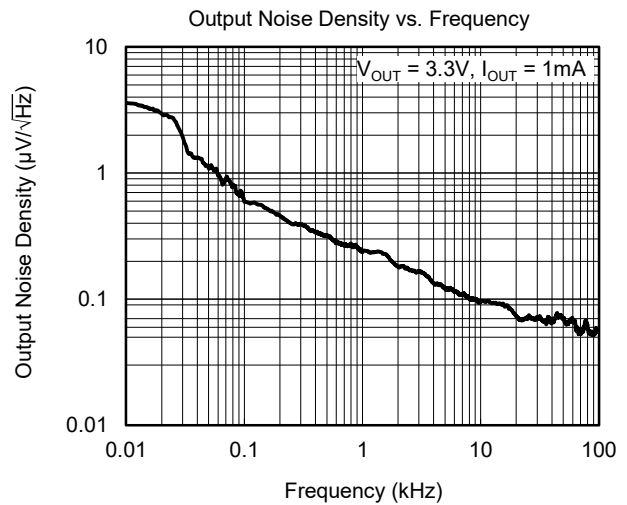
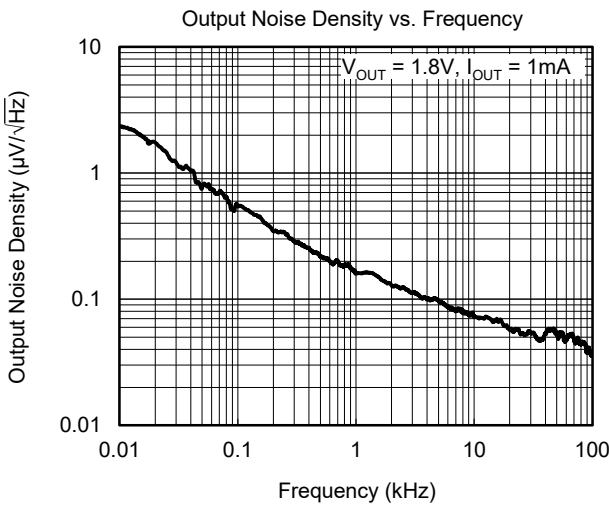
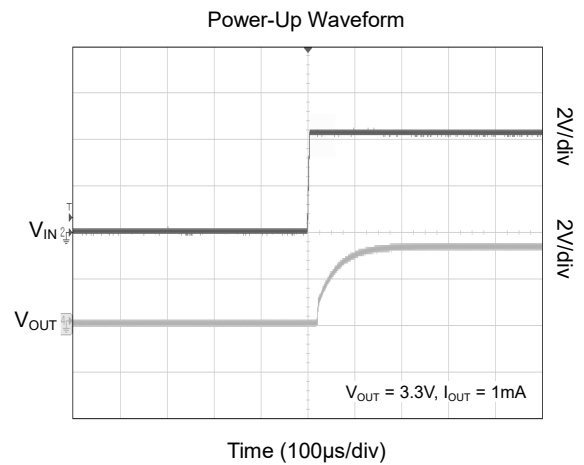
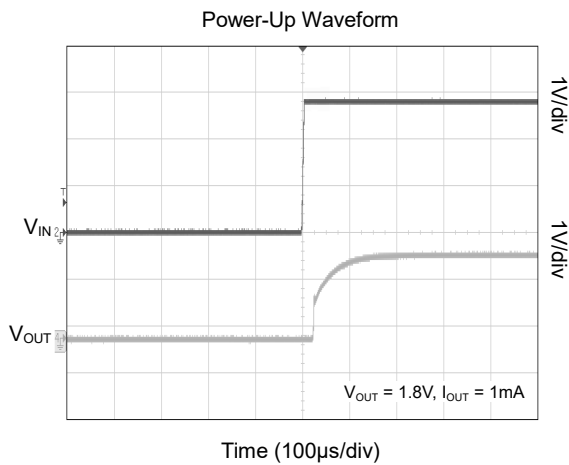
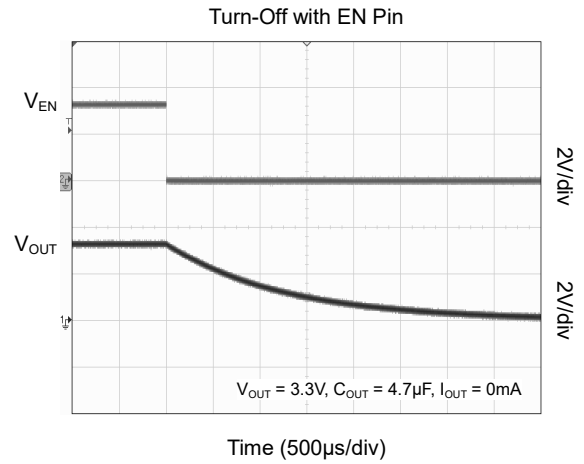
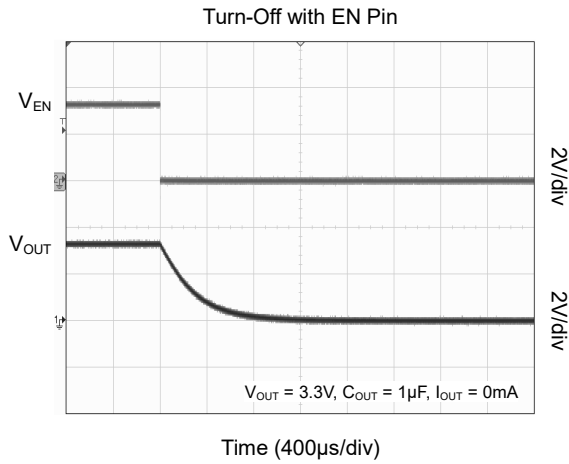



TYPICAL PERFORMANCE CHARACTERISTICS (continued)

$T_J = +25^\circ\text{C}$ ,  $V_{IN} = V_{OUT(NOM)} + 1.0\text{V}$ ,  $V_{EN} = V_{IN}$ ,  $C_{IN} = C_{OUT} = 1\mu\text{F}$ , unless otherwise noted.

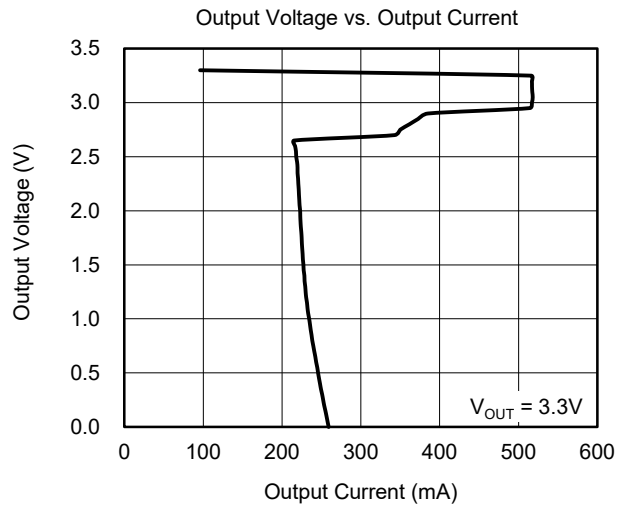
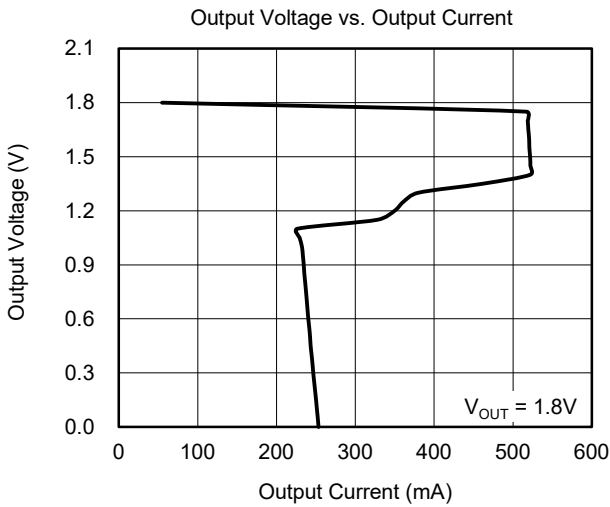
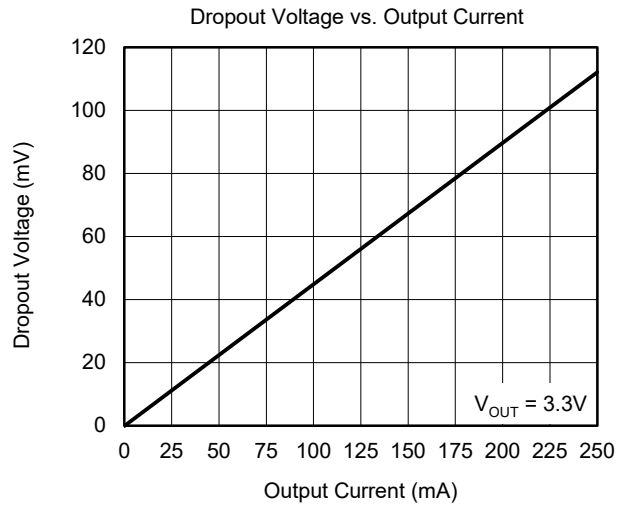
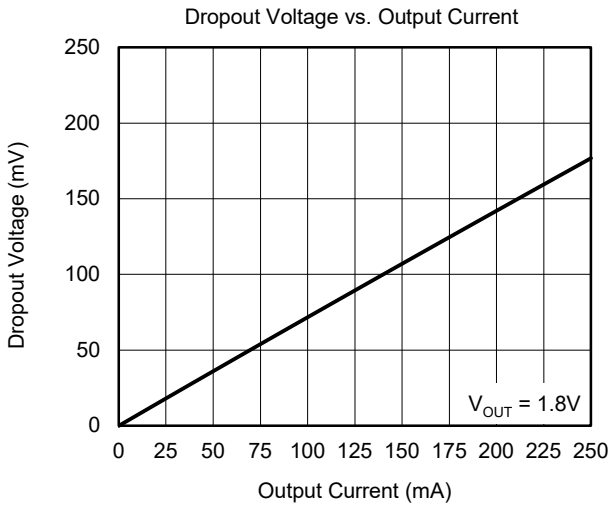
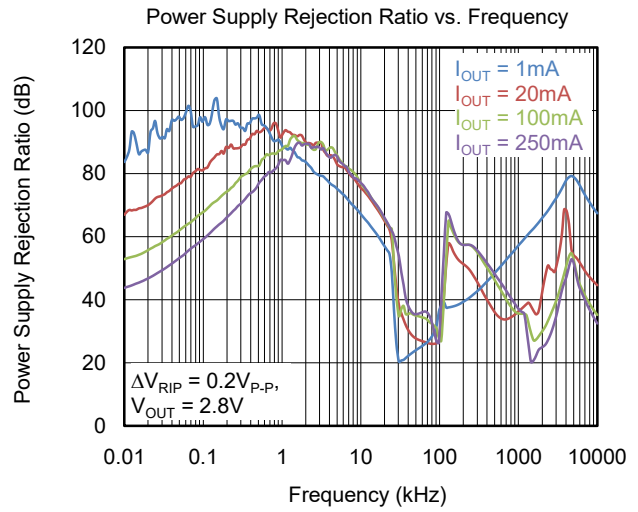
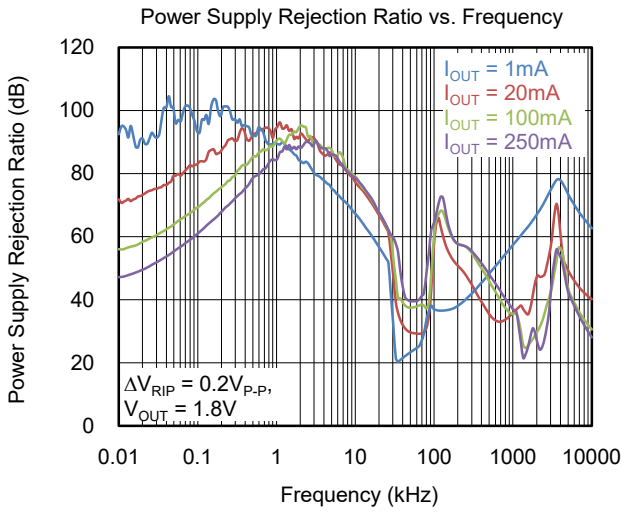

TYPICAL PERFORMANCE CHARACTERISTICS (continued)

$T_J = +25^\circ\text{C}$ ,  $V_{IN} = V_{OUT(NOM)} + 1.0\text{V}$ ,  $V_{EN} = V_{IN}$ ,  $C_{IN} = C_{OUT} = 1\mu\text{F}$ , unless otherwise noted.

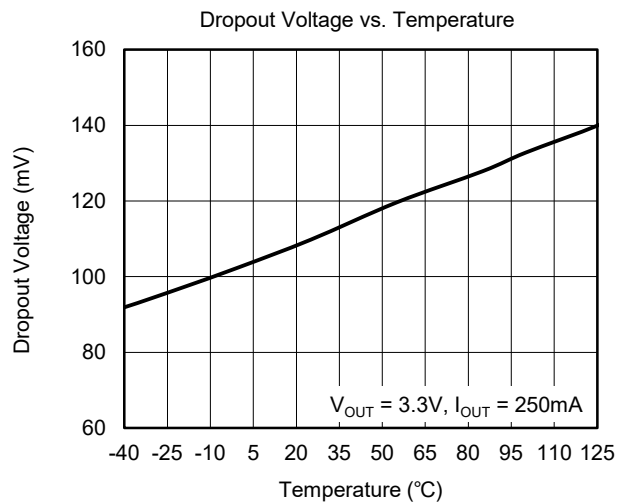
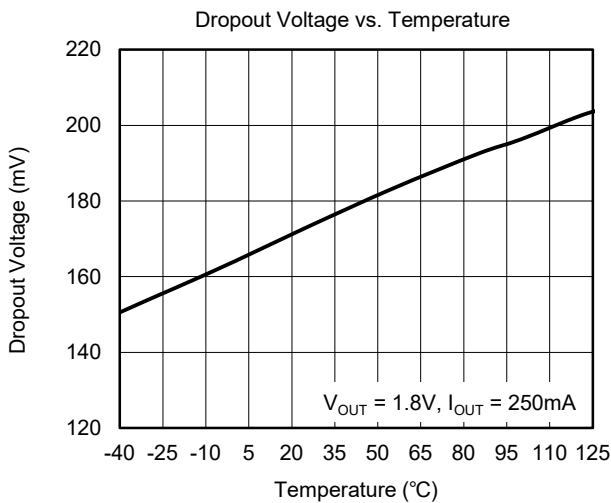
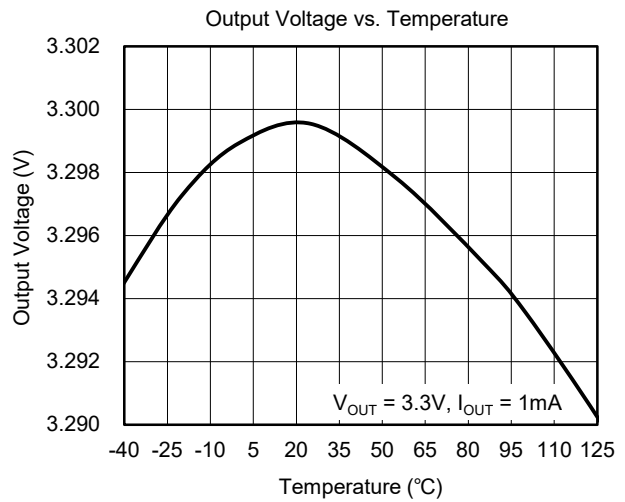
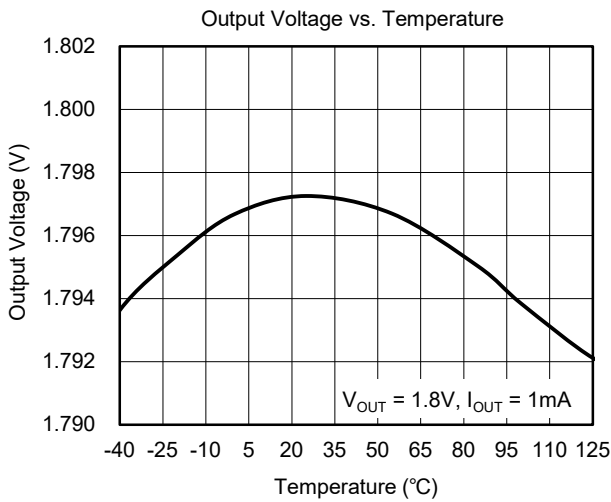
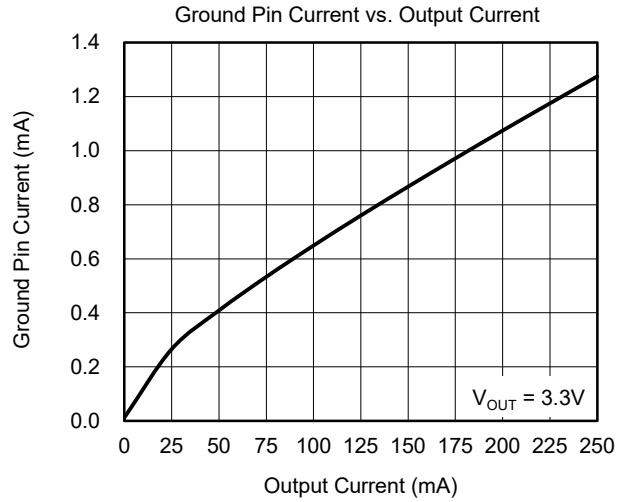
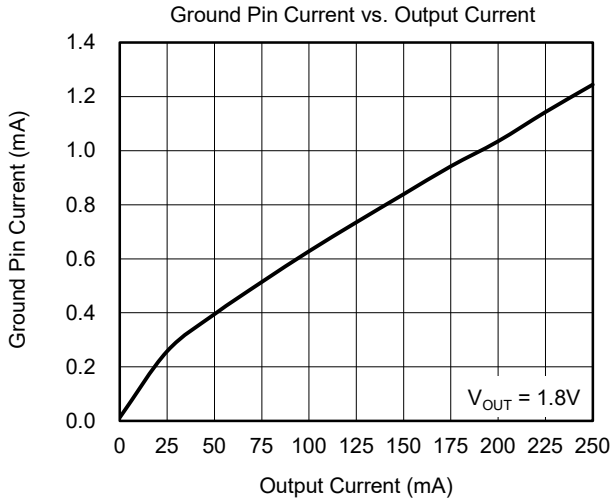

FUNCTIONAL BLOCK DIAGRAMS

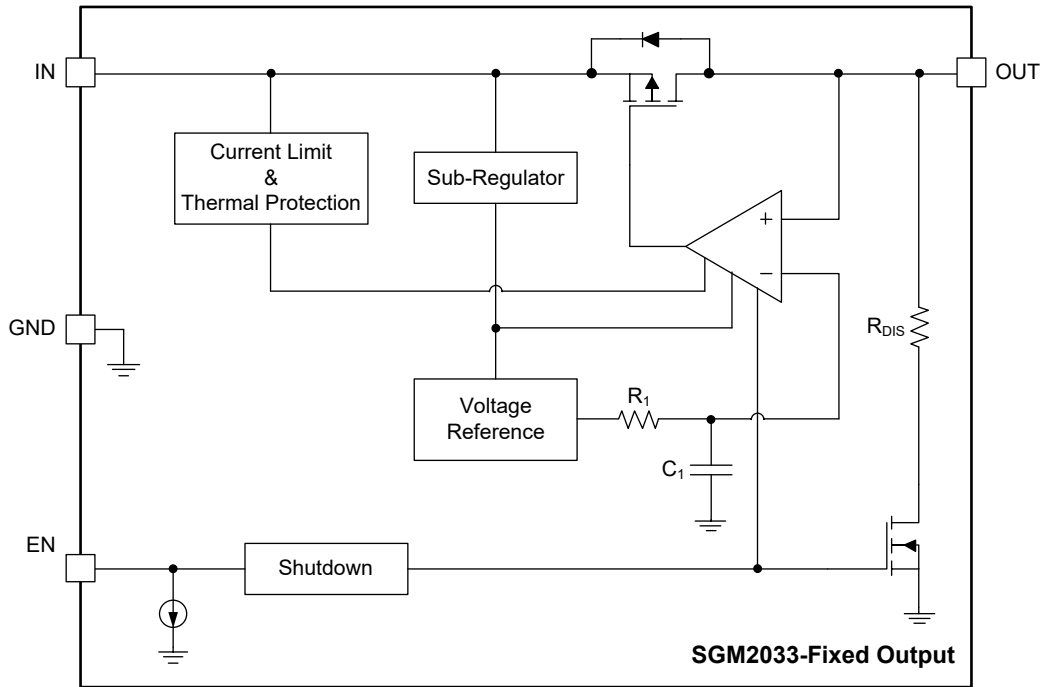

Figure 2. Fixed Output Voltage Block Diagram

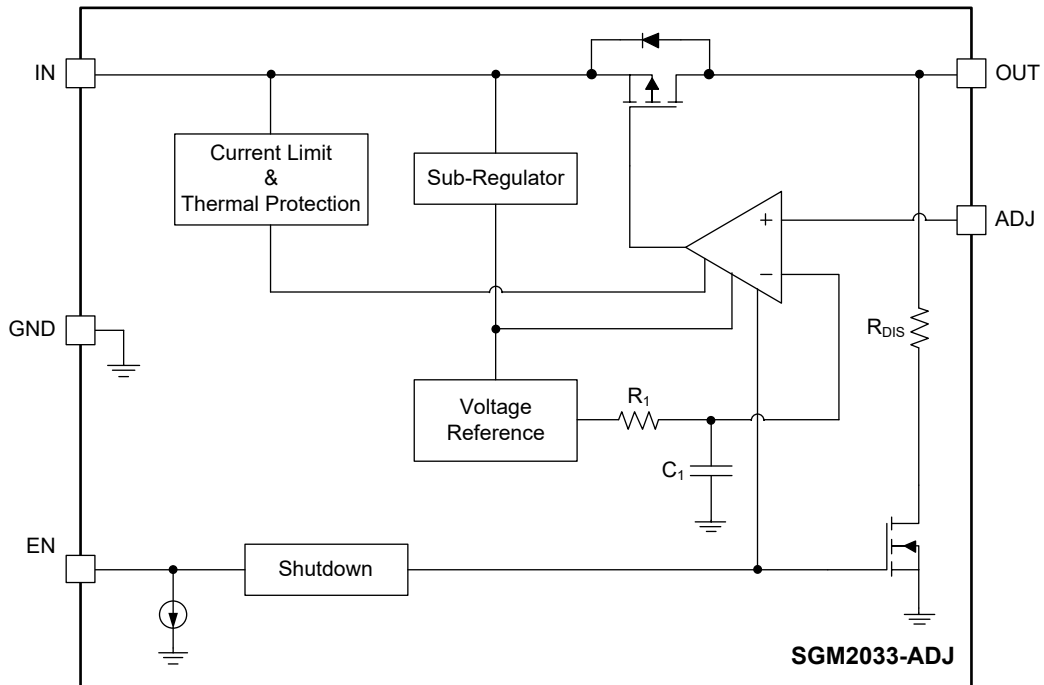

Figure 3. Adjustable Output Voltage Block Diagram

## APPLICATION INFORMATION

The SGM2033 is a low input voltage, ultra-low noise and low dropout LDO and provides 250mA output current. These features make the device a reliable solution to solve many challenging problems in the generation of clean and accurate power supply. The high performance also makes the SGM2033 useful in a variety of applications. The SGM2033 provides the protection function for output overload, output short-circuit condition and overheating.

The SGM2033 provides an EN pin as an external chip enable control to enable/disable the device. When the regulator is in shutdown state, the shutdown current consumes as low as 0.1μA (TYP).

### Input Capacitor Selection ( $C_{IN}$ )

The input decoupling capacitor is necessary to be connected as close as possible to the IN pin for ensuring the device stability. 0.1μF or greater X7R or X5R ceramic capacitor is selected to get good dynamic performance.

When  $V_{IN}$  is required to provide large current instantaneously, a large effective input capacitor is required. Multiple input capacitors can limit the input tracking inductance. Adding more input capacitors is available to restrict the ringing and to keep it below the device absolute maximum ratings.

### Output Capacitor Selection ( $C_{OUT}$ )

The output decoupling capacitor should be located as close as possible to the OUT pin. 1μF or greater X7R or X5R ceramic capacitor is selected to get good dynamic performance. The minimum effective capacitance of  $C_{OUT}$  that SGM2033 can remain stable is 0.5μF. For ceramic capacitor, temperature, DC bias and package size will change the effective capacitance, so enough margin of  $C_{OUT}$  must be considered in design. Larger capacitance and lower ESR  $C_{OUT}$  will help improve the load transient response and increase the high frequency PSRR.

### Enable Control

The SGM2033 uses the EN pin to enable/disable its device and to deactivate/activate the output automatic

discharge function.

When the EN pin voltage is lower than 0.4V, the device is in shutdown state, there is no current flowing from IN to OUT pins. In this state, the automatic discharge transistor is active to discharge the output voltage through a 220Ω (TYP) resistor.

When the EN pin voltage is higher than 1.5V, the device is in active state, the input voltage is regulated to the output voltage and the automatic discharge transistor is turned off.

The EN pin is pulled down by internal 0.2μA (TYP) current source when the EN pin is floated. This current source will ensure the SGM2033 in shutdown state and reduce the power dissipation in system.

### Adjustable Regulator

The output voltage of the SGM2033 can be adjusted from 1.2V to 5.0V. The ADJ pin will be connected with two external resistors as shown in Figure 4, the output voltage is determined by the following equation:

$$V_{OUT} = V_{FB} \times \left( 1 + \frac{R_1}{R_2} \right) \quad (1)$$

where:

$V_{OUT}$  is output voltage and  $V_{FB}$  is the internal voltage reference,  $V_{FB} = 1.2V$ .

One parallel capacitor ( $C_{FF} \geq 100pF$ ) with  $R_1$  can be used to improve the feedback loop stability and PSRR, increase the transient response and reduce the output noise. Use  $R_2 \leq 100k\Omega$  to maintain a 12μA minimum load.

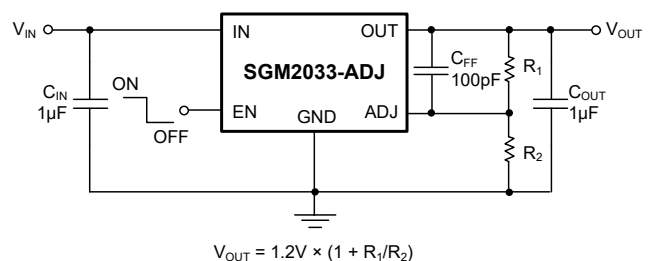

Figure 4. Adjustable Output Voltage Application

**APPLICATION INFORMATION (continued)**

**Output Current Limit and Short-Circuit Protection**

When overload events happen, the output current is internally limited to 500mA (TYP). When the OUT pin is shorted to ground, the short-circuit protection will limit the output current to 220mA (TYP).

**Thermal Shutdown**

The SGM2033 can detect the temperature of die. When the die temperature exceeds the threshold value of thermal shutdown, the SGM2033 will be in shutdown state and it will remain in this state until the die temperature decreases to +145°C.

**Power Dissipation (P<sub>D</sub>)**

Thermal protection limits power dissipation in the SGM2033. When power dissipation on pass element ( $P_D = (V_{IN} - V_{OUT}) \times I_{OUT}$ ) is too much that raise the operation junction temperature exceeds +165°C, the OTP circuit starts the thermal shutdown function and turns the pass element off.

Therefore, thermal analysis for the chosen application is important to guarantee reliable performance over all

conditions. To guarantee reliable operation, the junction temperature of the SGM2033 must not exceed 125°C.

In order to calculate the maximum power that the device can dissipate, the following formula is used:

$$P_{D(MAX)} = (125^{\circ}C - T_A) / \theta_{JA} \quad (2)$$

where  $T_A$  is the ambient temperature, and  $\theta_{JA}$  is the junction-to-ambient thermal resistance.

**Negatively Biased Output**

When the output is negative voltage, the chip may not start up due to parasitic effects. Ensure that the output is greater than -0.3V under all conditions. If excessive negatively biased output is expected in the application, a Schottky diode can be added between the OUT pin and GND pin.

**Reverse Current**

The pass transistor has an inherent body diode which will be forward biased in the case when  $V_{OUT} > (V_{IN} + 0.3V)$ . If extended reverse voltage operation is anticipated, external limiting might be appropriate.

**REVISION HISTORY**

NOTE: Page numbers for previous revisions may differ from page numbers in the current version.

<b>FEBRUARY 2022 – REV.A.2 to REV.A.3</b> .....	<b>Page</b>
Updated Package Outline Dimensions.....	15
<b>MARCH 2020 – REV.A.1 to REV.A.2</b> .....	<b>Page</b>
Updated Typical Performance Characteristics .....	10
Added SGM2033-ADJXN5G/TR version.....	All
<b>JULY 2019 – REV.A to REV.A.1</b> .....	<b>Page</b>
Updated Typical Performance Characteristics .....	9
<b>Changes from Original (NOVEMBER 2018) to REV.A</b> .....	<b>Page</b>
Changed from product preview to production data.....	All

PACKAGE OUTLINE DIMENSIONS

SOT-23-5

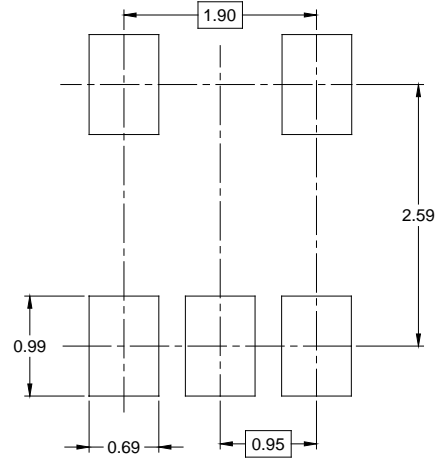
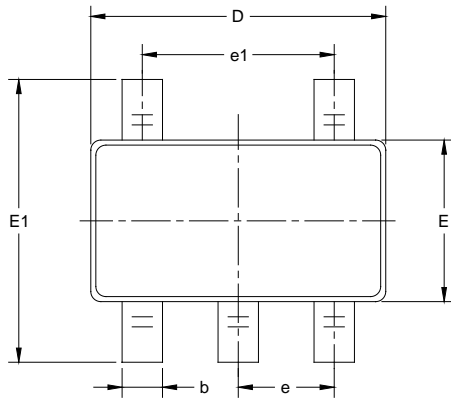

RECOMMENDED LAND PATTERN (Unit: mm)

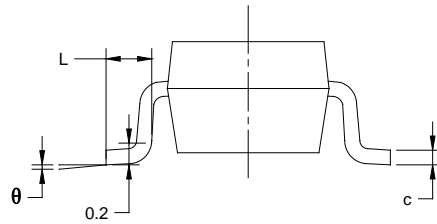
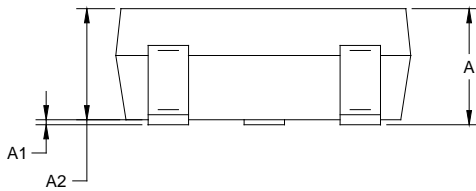

Symbol	Dimensions In Millimeters		Dimensions In Inches	
	MIN	MAX	MIN	MAX
A	1.050	1.250	0.041	0.049
A1	0.000	0.100	0.000	0.004
A2	1.050	1.150	0.041	0.045
b	0.300	0.500	0.012	0.020
c	0.100	0.200	0.004	0.008
D	2.820	3.020	0.111	0.119
E	1.500	1.700	0.059	0.067
E1	2.650	2.950	0.104	0.116
e	0.950 BSC		0.037 BSC	
e1	1.900 BSC		0.075 BSC	
L	0.300	0.600	0.012	0.024
$\theta$	0°	8°	0°	8°

NOTES:

1. Body dimensions do not include mode flash or protrusion.
2. This drawing is subject to change without notice.

PACKAGE OUTLINE DIMENSIONS

UTDFN-1×1-4AL

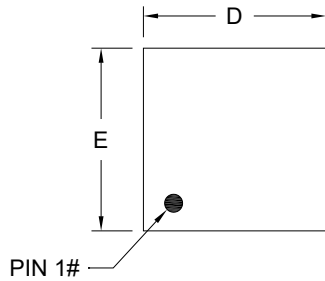

TOP VIEW

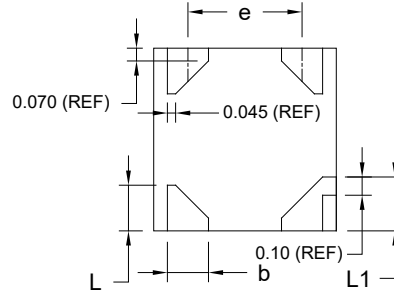

BOTTOM VIEW

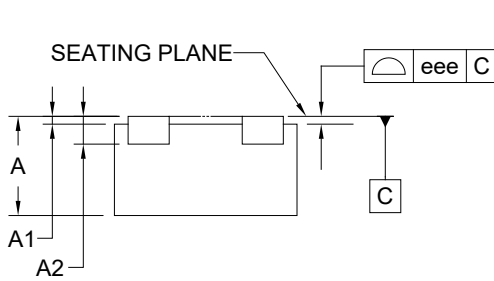

SIDE VIEW

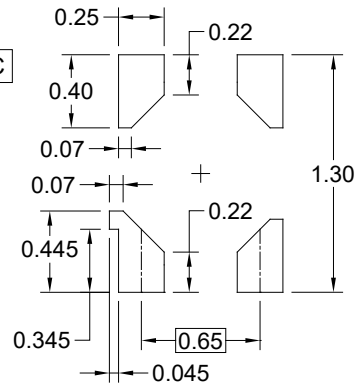

RECOMMENDED LAND PATTERN (Unit: mm)

Symbol	Dimensions In Millimeters		
	MIN	MOD	MAX
A	0.500	0.550	0.600
A1	0.000	-	0.050
A2	0.152 REF		
e	0.625 BSC		
D	0.950	1.000	1.050
E	0.950	1.000	1.050
b	0.175	0.225	0.275
L	0.200	0.250	0.300
L1	0.245	0.295	0.345
eee	0.050		

NOTE: This drawing is subject to change without notice.

# PACKAGE INFORMATION

## TAPE AND REEL INFORMATION

### REEL DIMENSIONS



### TAPE DIMENSIONS



NOTE: The picture is only for reference. Please make the object as the standard.

### KEY PARAMETER LIST OF TAPE AND REEL

Package Type	Reel Diameter	Reel Width W1 (mm)	A0 (mm)	B0 (mm)	K0 (mm)	P0 (mm)	P1 (mm)	P2 (mm)	W (mm)	Pin1 Quadrant
SOT-23-5	7"	9.5	3.20	3.20	1.40	4.0	4.0	2.0	8.0	Q3
UTDFN-1×1-4AL	7"	9.0	1.16	1.16	0.63	4.0	2.0	2.0	8.0	Q1

000001



# PACKAGE INFORMATION

## CARTON BOX DIMENSIONS



NOTE: The picture is only for reference. Please make the object as the standard.

## KEY PARAMETER LIST OF CARTON BOX

Reel Type	Length (mm)	Width (mm)	Height (mm)	Pizza/Carton
7" (Option)	368	227	224	8
7"	442	410	224	18

DD0002

单击下面可查看定价，库存，交付和生命周期等信息

[>>SGMICRO\(圣邦微电子\)](#)