

SOT-89-3L Plastic-Encapsulate Transistors

BCX54,BCX55,BCX56 TRANSISTOR (NPN)

FEATURES

- PNP Complements to BCX51,BCX52,BCX53
- Low Voltage
- High Current

APPLICATIONS

- Driver Stages of Audio Amplifiers

MARKING:BCX54:BA, BCX54-10:BC, BCX54-16:BD
BCX55:BE, BCX55-10:BG, BCX55-16BM
BCX56:B H, BCX56-10:BK, BCX56-16:BL

MAXIMUM RATINGS (T_a=25°C unless otherwise noted)

Symbol	Parameter	Value	Unit
V _{CBO}	Collector-Base Voltage	BCX54	45
		BCX55	60
		BCX56	100
V _{CEO}	Collector-Emitter Voltage	BCX54	45
		BCX55	60
		BCX56	80
V _{EBO}	Emitter-Base Voltage	5	V
I _C	Collector Current	1	A
I _B	Base Current	0.1	A
I _{BM}	Peak base Current (tp<1ms)	0.2	A
P _C	Collector Power Dissipation	500	mW
R _{θJA}	Thermal Resistance From Junction To Ambient	250	°C/W
T _J ,T _{stg}	Operation Junction and Storage Temperature Range	-55~+150	°C
T _{opr}	Operation Temperature Range	-25~+125	°C

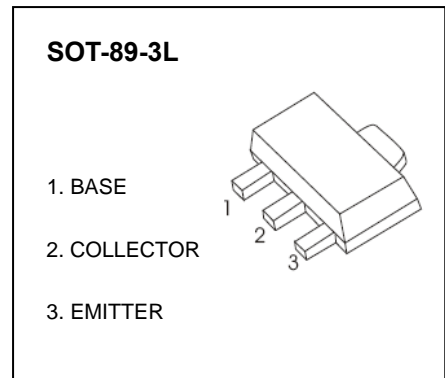

Parameter	Symbol	Test conditions	Min	Typ	Max	Unit
Collector-base breakdown voltage	$V_{(BR)CBO}$	$I_C=100\mu A, I_E=0$	BCX54	45		V
			BCX55	60		
			BCX56	100		
Collector-emitter breakdown voltage	$V_{(BR)CEO^*}$	$I_C=10mA, I_B=0$	BCX54	45		V
			BCX55	60		
			BCX56	80		
Emitter-base breakdown voltage	$V_{(BR)EBO}$	$I_E=10\mu A, I_C=0$	5			V
Collector cut-off current	I_{CBO}	$V_{CB}=30V, I_E=0$			0.1	μA
Emitter cut-off current	I_{EBO}	$V_{EB}=5V, I_C=0$			0.1	μA
DC current gain	$h_{FE(1)^*}$	$V_{CE}=2V, I_C=5mA$	40			
	$h_{FE(2)^*}$	$V_{CE}=2V, I_C=150mA$	63		250	
	$h_{FE(3)^*}$	$V_{CE}=2V, I_C=0.5A$	25			
Collector-emitter saturation voltage	$V_{CE(sat)^*}$	$I_C=0.5A, I_B=50mA$			0.5	V
Base -emitter voltage	V_{BE^*}	$V_{CE}=2V, I_C=0.5A$			1	V
Transition frequency	f_T	$V_{CE}=5V, I_C=10mA, f=100MHz$		130		MHz

* Pulse Test

CLASSIFICATION OF $h_{FE(2)}$

RANK	BCX54 BCX55 BCX56	BCX54-10 BCX55-10 BCX56-10	BCX54-16 BCX55-16 BCX56-16
RANGE	63 - 250	63 - 160	100 - 250

Typical Characteristics

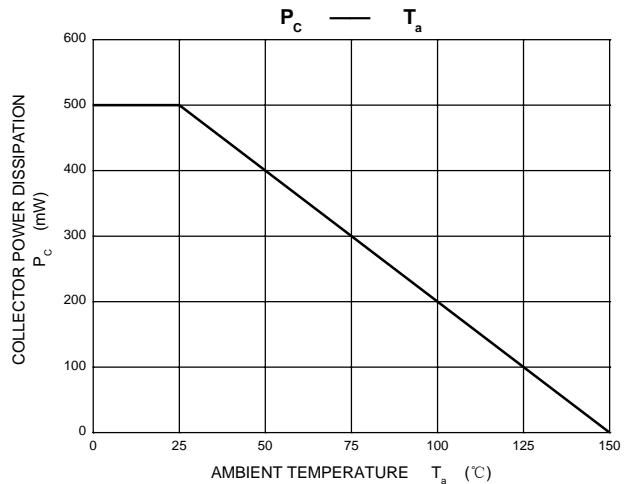
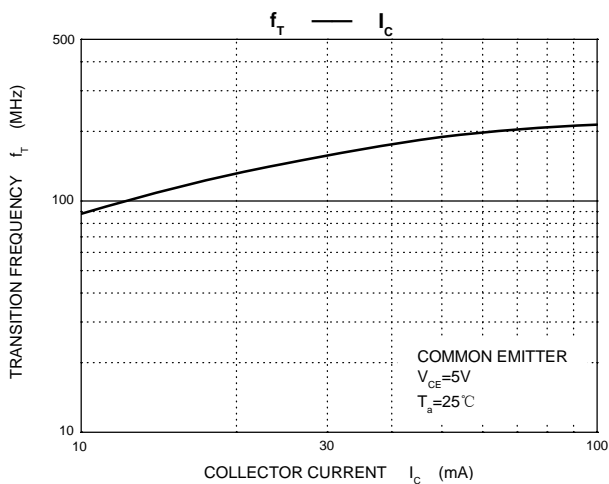
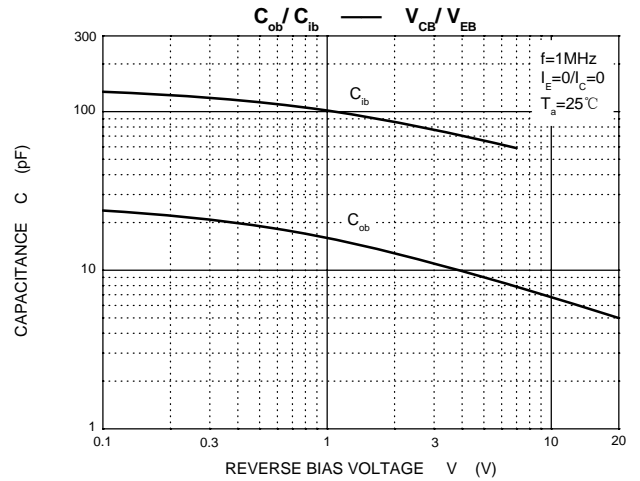
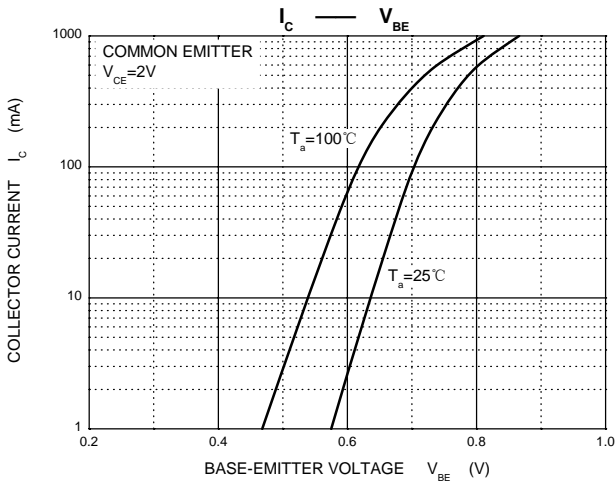
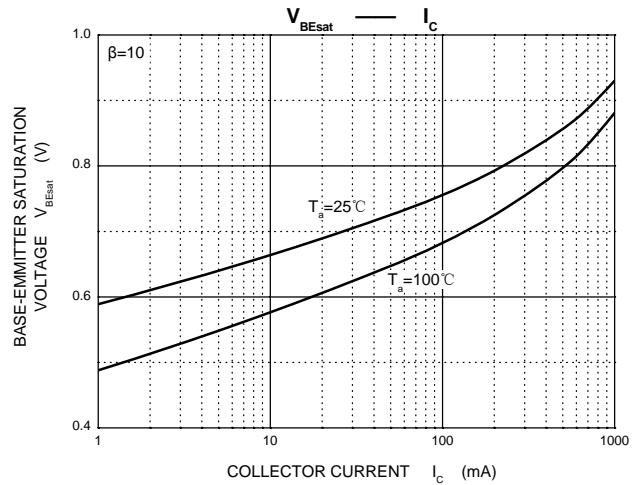
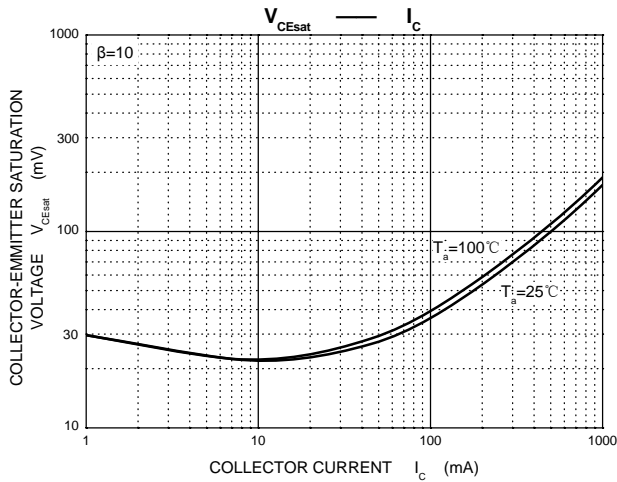
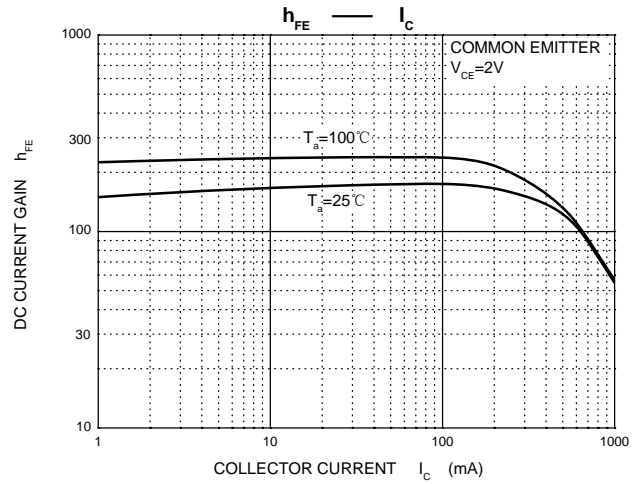
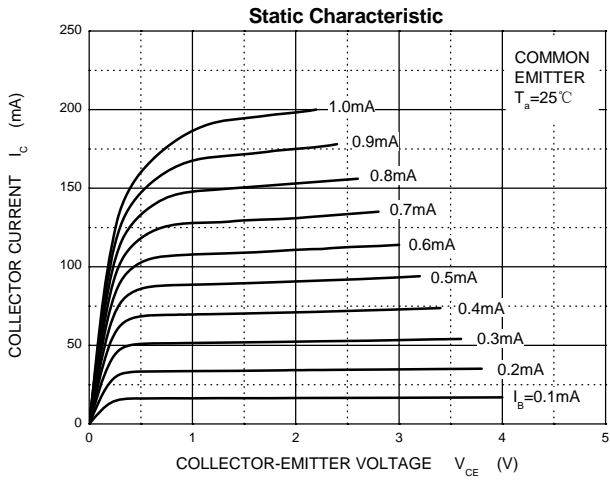

SOT-89-3L Package Outline Dimensions

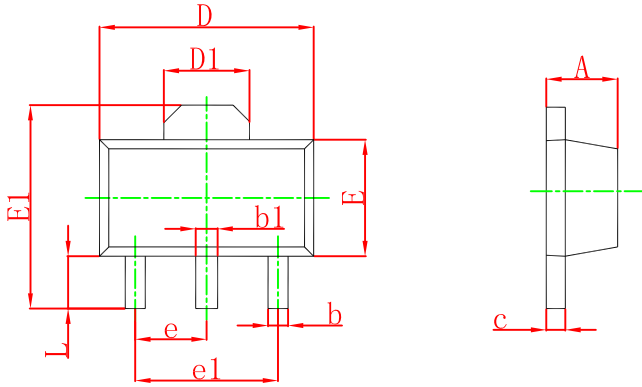

Symbol	Dimensions In Millimeters		Dimensions In Inches	
	Min	Max	Min	Max
A	1.400	1.600	0.055	0.063
b	0.320	0.520	0.013	0.020
b1	0.400	0.580	0.016	0.023
c	0.350	0.440	0.014	0.017
D	4.400	4.600	0.173	0.181
D1	1.550 REF.		0.061 REF.	
E	2.300	2.600	0.091	0.102
E1	3.940	4.250	0.155	0.167
e	1.500 TYP.		0.060 TYP.	
e1	3.000 TYP.		0.118 TYP.	
L	0.900	1.200	0.035	0.047

SOT-89-3L Suggested Pad Layout

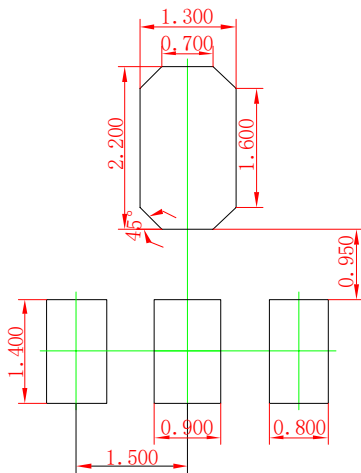

Note:

1. Controlling dimension: in millimeters.
2. General tolerance: ± 0.05 mm.
3. The pad layout is for reference purposes only.

NOTICE

JSCJ reserves the right to make modifications, enhancements, improvements, corrections or other changes without further notice to any product herein. JSCJ does not assume any liability arising out of the application or use of any product described herein.

SOT-89-3L Tape and Reel

SOT-89-3L Embossed Carrier Tape

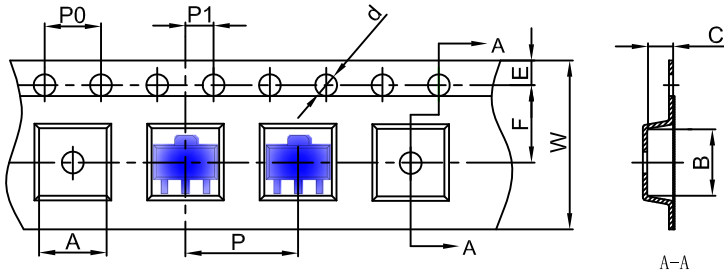

Packaging Description:

SOT-89-3L parts are shipped in tape. The carrier tape is made from a dissipative (carbon filled) polycarbonate resin. The cover tape is a multilayer film (Heat Activated Adhesive in nature) primarily composed of polyester film, adhesive layer, sealant, and anti-static sprayed agent. These reeled parts in standard option are shipped with 1,000 units per 7" or 18.0 cm diameter reel. The reels are clear in color and is made of polystyrene plastic (anti-static coated).

Dimensions are in millimeter										
Pkg type	A	B	C	d	E	F	P0	P	P1	W
SOT-89-3L	4.85	4.45	1.85	Ø1.50	1.75	5.50	4.00	8.00	2.00	12.00

SOT-89-3L Tape Leader and Trailer

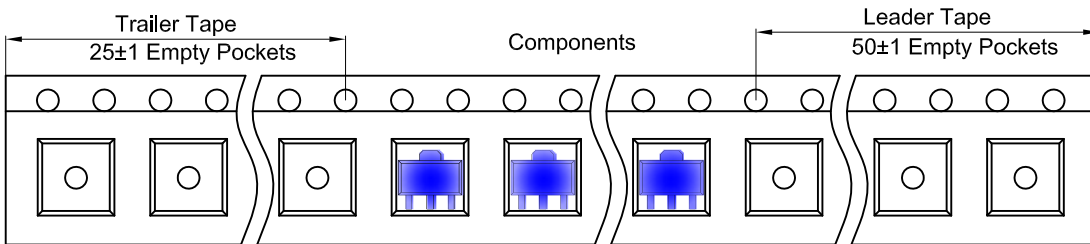

SOT-89-3L Reel

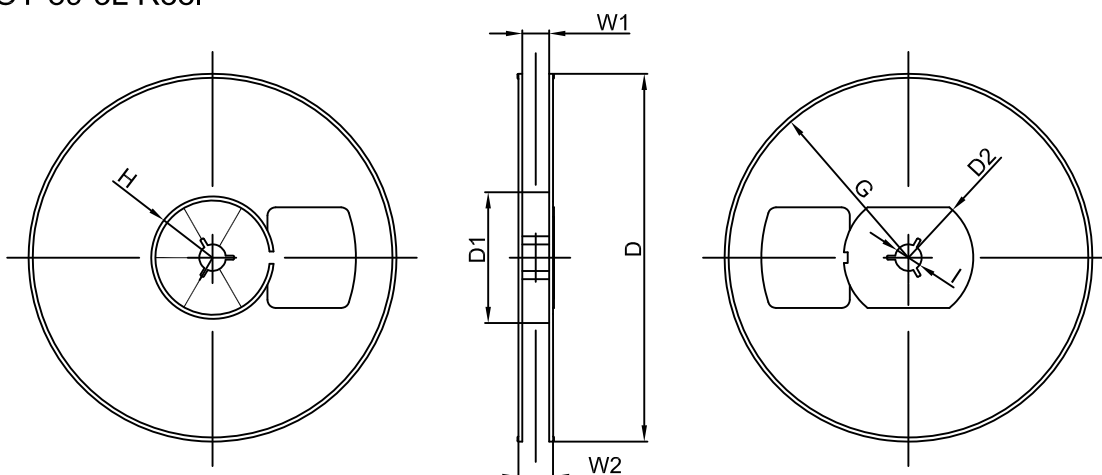

Dimensions are in millimeter								
Reel Option	D	D1	D2	G	H	I	W1	W2
7" Dia	Ø180.00	60.00	R32.00	R86.50	R30.00	Ø13.00	13.20	16.50

REEL	Reel Size	Box	Box Size(mm)	Carton	Carton Size(mm)	G.W.(kg)
1000 pcs	7 inch	10,000 pcs	203×203×195	40,000 pcs	438×438×220	

单击下面可查看定价，库存，交付和生命周期等信息

[>>JSCJ](#)