

High Power Infrared LED (Product Specification)

Approval Sheet

PR35V30 V0
 Product Specification

RoHS

Product	IR Emitter
Part Number	PR35V30 V0
Customer Part Number	
Issue Date	2016/03/07
Update Date	2019/04/10



Features

- ✓ Compact dimensions: 3.55 mm × 3.55 mm
- ✓ Peak wavelength: $\lambda_p = 850 \text{ nm}$
- ✓ High power operation
- ✓ View angle: $\theta = 120^\circ/90^\circ/60^\circ/130 \times 80^\circ$
- ✓ Low thermal resistance
- ✓ Environmental friendly ; RoHS compliance
- ✓ Qualified according to JEDEC moisture sensitivity Level 3

Applications

- ✓ Surveillance system
- ✓ Industrial automatic vision system
- ✓ Infrared illumination for camera
- ✓ Face recognition systems
- ✓ Eye tracking systems
- ✓ Gesture recognition systems

MAKER			CUSTOMER			
Prepared	Checked	Approved				
Matthew Tsai	JT Chu	Sherry Chiu				

Outline Dimension

PR35V30 V0

Product Specification

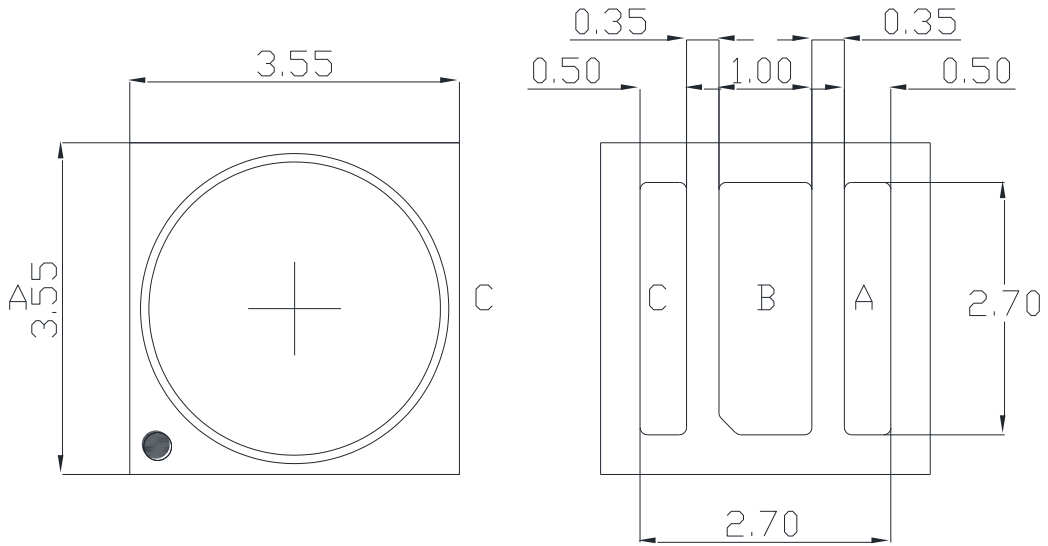

Unit: mm

Tolerance: $\pm 0.15\text{mm}$

A: Anode

B: Anode

C: Cathode

Dimension for 120°

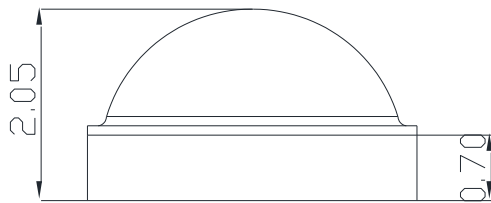

Dimension for 90°

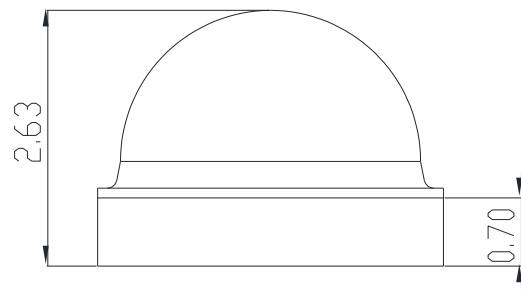

Dimension for 60°

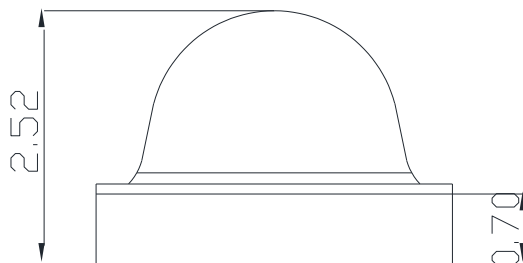

Outline Dimension

PR35V30 V0

Product Specification

■ Dimension for 130°x80°

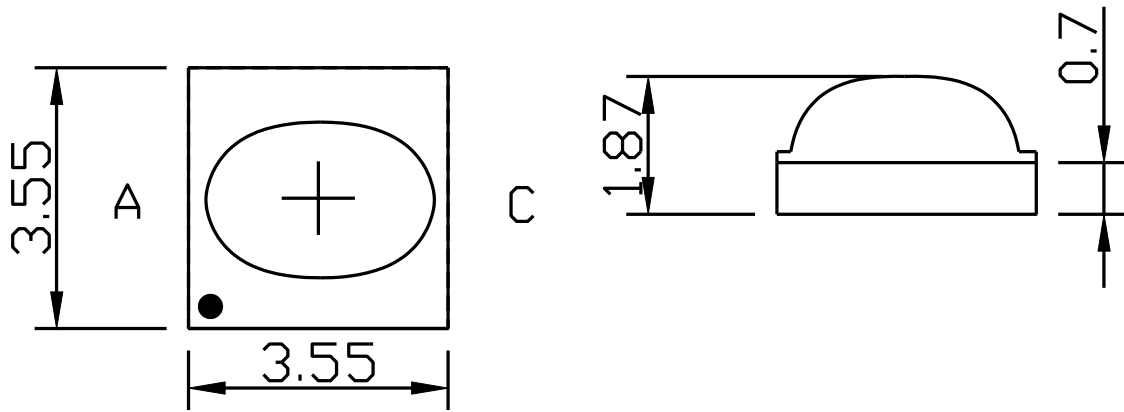

Characteristics

PR35V30 V0

Product Specification

Room Temperature Opto-Electronic Characteristics

Parameter	Symbol	Condition	View Angle ⁽³⁾	Min.	Typical	Max.	Unit
Forward Voltage ⁽¹⁾	V_F	$I_F = 0.35 \text{ A}$	--	--	1.55	--	V
Wavelength	λ_p	$I_F = 0.35 \text{ A}$	--	--	850	--	nm
Radiant Power	Φ_e	$I_F = 0.35 \text{ A}$	--	--	250	--	mW
Radiant Intensity ⁽²⁾	I_e	$I_F = 0.35 \text{ A}$	120°	--	75	--	mW/sr
			90°	--	115	--	
			60°	--	190	--	
			130°x80°	--	85	--	

Parameter	Symbol	Condition	View Angle ⁽³⁾	Min.	Typical	Max.	Unit
Forward Voltage ⁽¹⁾	V_F	$I_F = 1 \text{ A}$	--	--	1.75	--	V
Wavelength	λ_p	$I_F = 1 \text{ A}$	--	--	850	--	nm
Radiant Power	Φ_e	$I_F = 1 \text{ A}$	--	--	640	--	mW
Radiant Intensity ⁽²⁾	I_e	$I_F = 1 \text{ A}$	120°	--	200	--	mW/sr
			90°	--	300	--	
			60°	--	480	--	
			130°x80°	--	215	--	

(1). Forward Voltage tolerance is $\pm 0.1 \text{ V}$

(2). Radiant Intensity tolerance is $\pm 10\%$

(3). View Angle tolerance is ± 10

(4). Optical and electronic characteristics testing condition is 10ms pulse.

Temperature-dependent Opto-Electronic Characteristics

Parameter	Symbol	Condition	Min.	Typical	Max.	Unit
Forward Voltage	V_F	$I_F = 0.35 \text{ A}, t_p = 10 \text{ ms}$	--	-1.0	--	mV/°C
Wavelength	λ_p	$I_F = 0.35 \text{ A}, t_p = 10 \text{ ms}$	--	0.27	--	nm/°C
Radiant Power	I_e	$I_F = 0.35 \text{ A}, t_p = 10 \text{ ms}$	--	-0.27	--	%/°C
Radiant Intensity	Φ_e	$I_F = 0.35 \text{ A}, t_p = 10 \text{ ms}$	--	-0.27	--	%/°C

Characteristics

PR35V30 V0

Product Specification

Absolute Maximum Ratings

Parameter	Symbol	Value	Unit
DC Forward Current ⁽¹⁾	I_F	1	A
Power Consumption	P_{tot}	2.3	W
Reverse Voltage	V_R	5	V
Junction Temperature	T_J	115	°C
Storage Temperature	T_S	-40 ~ 125	°C
Operation Temperature	T_{op}	-40 ~ 85	°C
Thermal Resistance –solder point	R_{thJS}	15	k/W
Soldering Temperature ⁽²⁾	T_{Sol}	260	°C

(1) Proper current rating must be observed to maintain junction temperature below maximum at all time.

(2) JEDEC J-STD-020 Latest version compliant. See profile and conditions in following page.

Ordering Code

PR35V30 V0

Product Specification

Ordering Code

P	R	3	5	V	3	0		V	0	-	1	3	0	D
---	---	---	---	---	---	---	--	---	---	---	---	---	---	---

Model name

Version no.

Angel:

120D=120°

90D=90°

60D=60°

130D=130×80°

Bin Table

PR35V30 V0
 Product Specification

■ Wavelength Rank (Ta=25°C)

W _P Rank	Typ.	Unit	Condition
10000	850	nm	I _F =350mA

■ Radiant Power Rank (Ta=25°C)

P _O Rank	Min.	Max.	Unit	Condition
F0	180	220	mW	I _F =350mA
F1	220	260	mW	I _F =350mA
F2	260	300	mW	I _F =350mA

■ Forward Voltage Rank (Ta=25°C)

V _F Rank	Min.	Max.	Unit	Condition
1	1.4	1.6	V	I _F =350mA
2	1.6	1.8	V	I _F =350mA
3	1.8	2.0	V	I _F =350mA

■ Bin code definition (for example)

W _P Rank	P _O Rank	V _F Rank
10000	F1	2

Characteristics

PR35V30 V0

Product Specification

Emission Spectrum

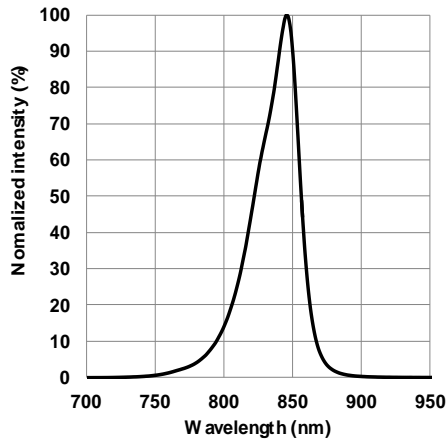

Radiation Pattern for 120°

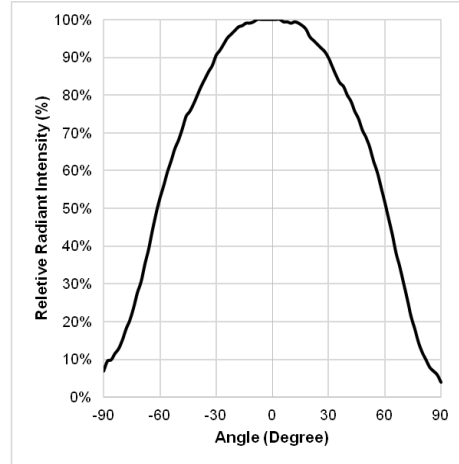

Radiation Pattern for 90°

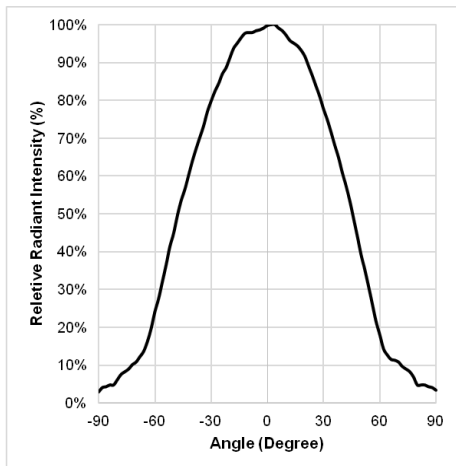

Radiation Pattern for 60°

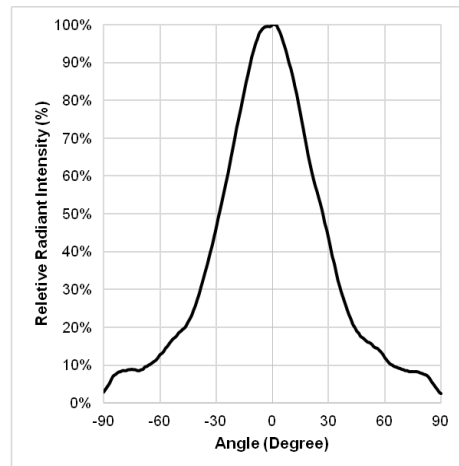

Radiation Pattern for 130°

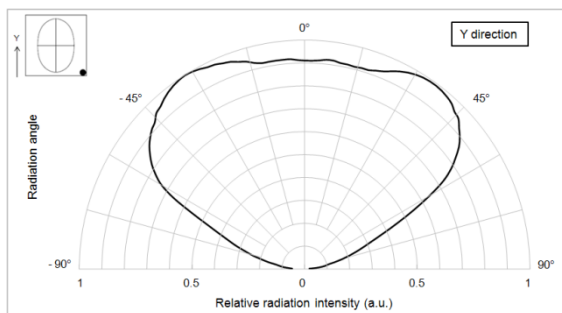

Radiation Pattern for 80°

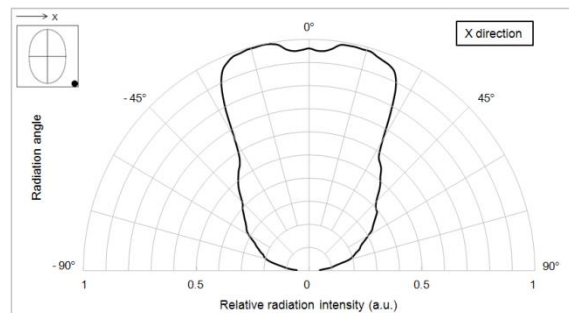

Characteristics

PR35V30 V0

Product Specification

Light output vs. Current

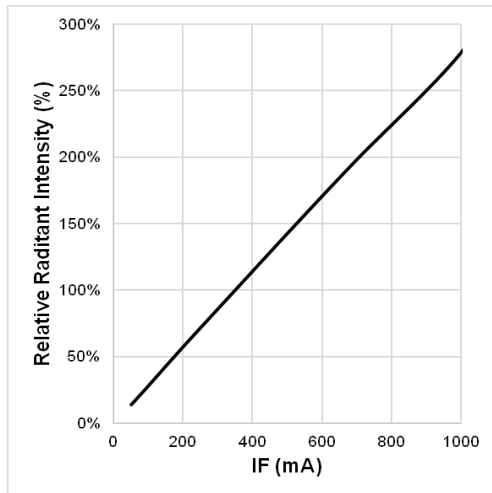

Voltage vs. Current

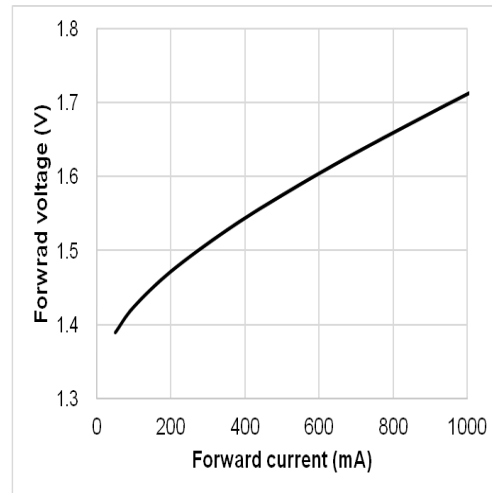

Max. permissible forward current

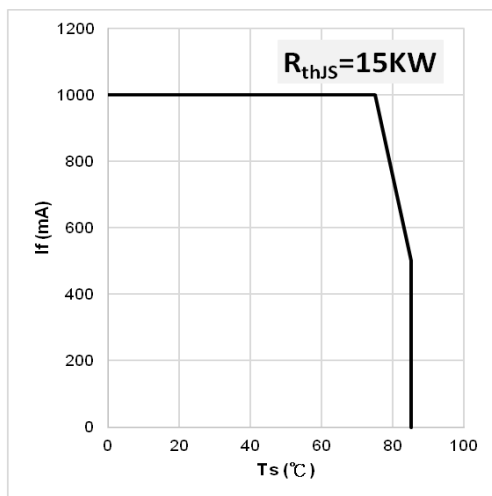

Packing

PR35V30 V0
Product Specification

Label

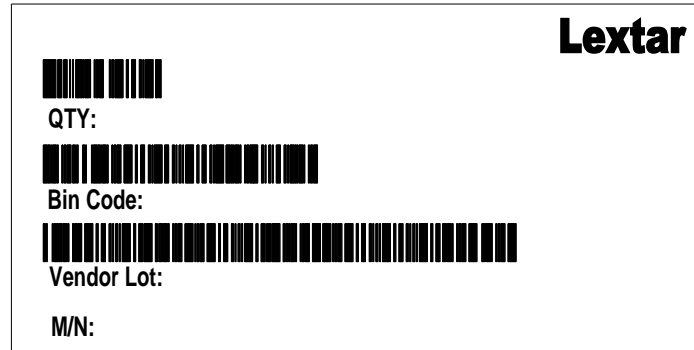

Packing Process

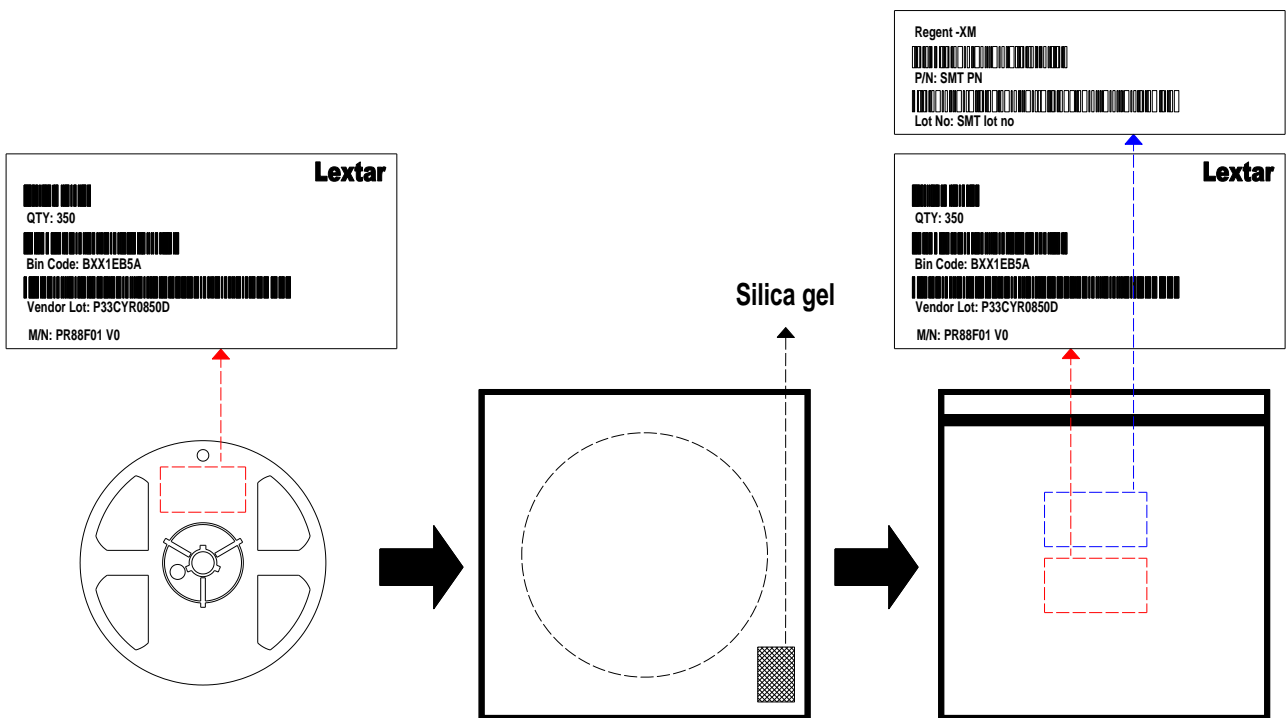

Packing

PR35V30 V0
 Product Specification

Carrier Dimensions

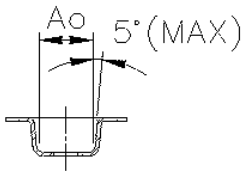
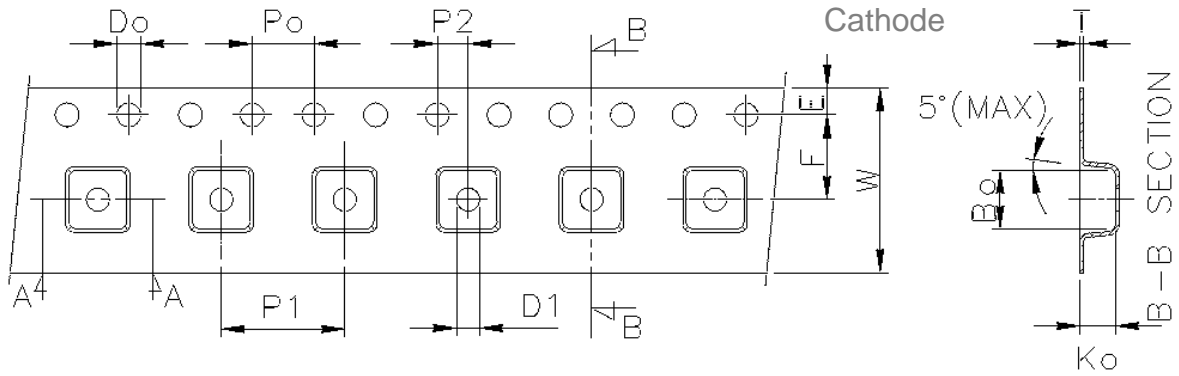

A-A SECTION

UNIT:mm

Symbol	A_o	B_o	P_o	P_1	P_2	T	E
Spec	3.85 ± 0.20	3.85 ± 0.20	4.00 ± 0.10	8.00 ± 0.10	2.00 ± 0.05	0.3 ± 0.10	1.75 ± 0.10
Symbol	F	D_o	D_1	W	$K_o(\text{Angle}=120^\circ)$	$K_o(\text{Angle}=90^\circ)$	$K_o(\text{Angle}=60^\circ)$
Spec	5.5 ± 0.05	1.50 ± 0.1	1.50 ± 0.10	12.0 ± 0.30	2.30 ± 0.10	2.90 ± 0.10	2.80 ± 0.10
Symbol	$K_o(\text{Angle}=130^\circ)$						
Spec	2.10 ± 0.10						

Reel Dimensions

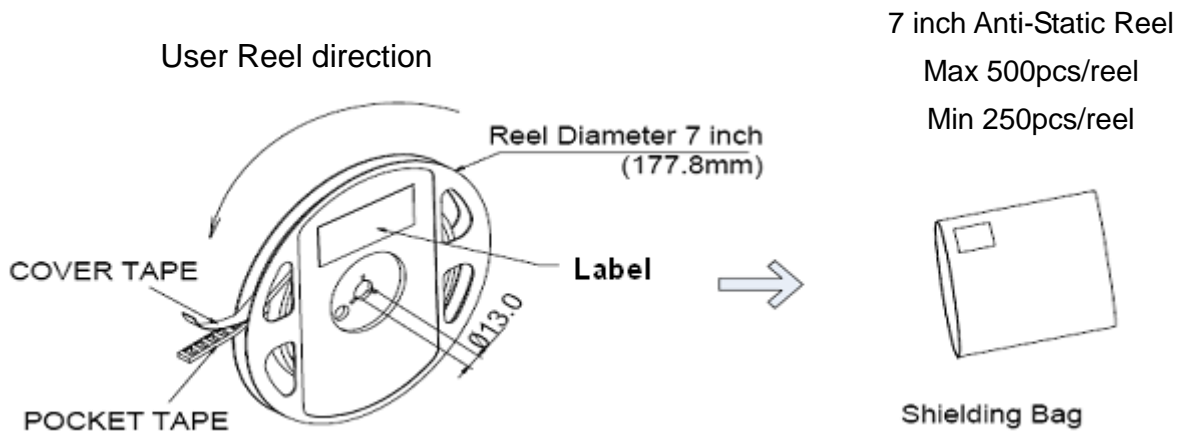

Packing

PR35V30 V0

Product Specification

■ Small Box

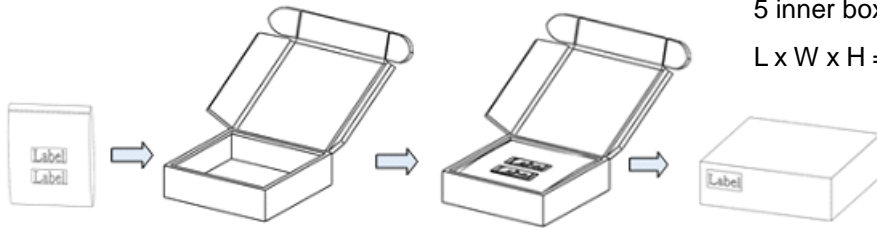

■ Medium Box

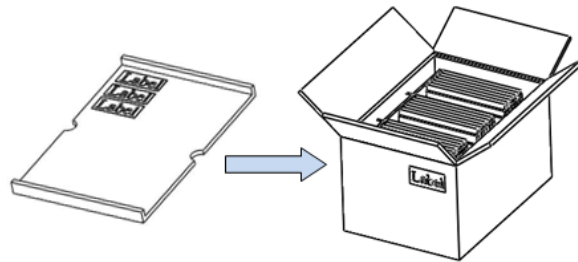
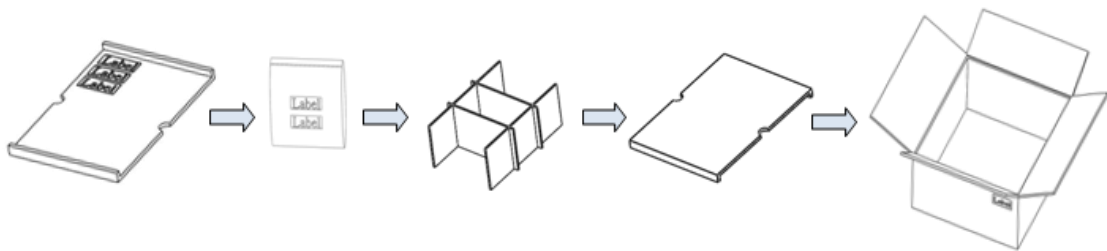

■ Large Box

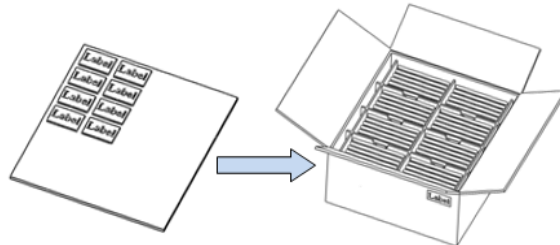
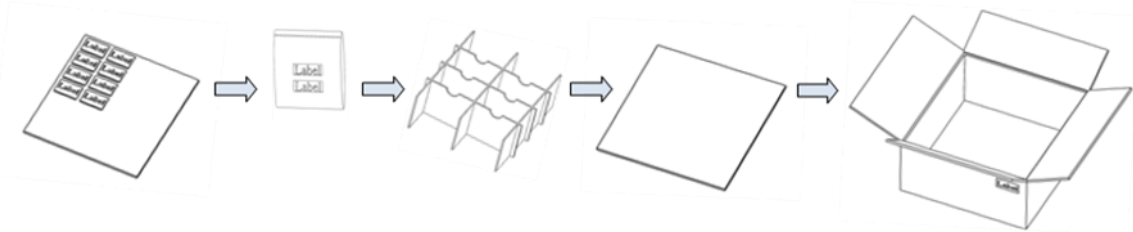

Application Notes

PR35V30 V0

Product Specification

Soldering PAD Design

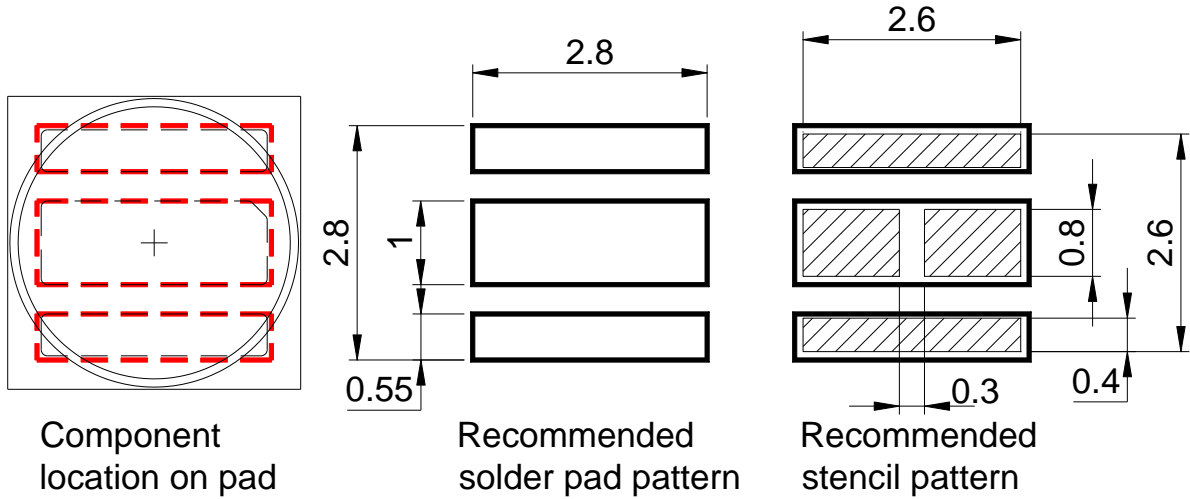

Recommended Reflow Soldering Profile (JEDEC-STD-020 latest version compliant)

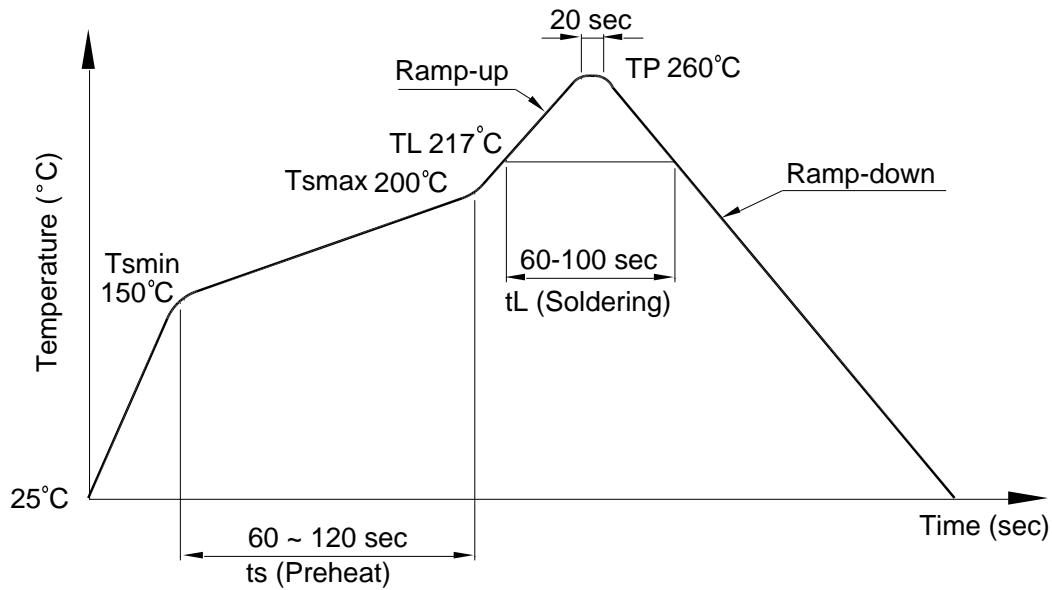

Application Notes

PR35V30 V0
Product Specification

Profile Items	Conditions
Preheat	
-Temperature Min.(T_{Smin})	150°C
-Temperature Max.(T_{Smax})	200°C
-Time(Min. to Max.)(t_S)	90±30 sec
Soldering Zone	
-Temperature(T_L)	217°C
-Time	60~100 sec
Peak Temperature(T_P)	260°C
Ramp-up rate	3°C / sec max.
Ramp-down rate	3~6°C / sec

Note:

1. One time soldering is recommended; do not exceed 3 times reflow process.
2. The recommended peak temperature is 245°C. The maximum soldering temperature should be controlled under 260°C.

Precaution

PR35V30 V0

Product Specification

■ Use Applications

- The products are not intended to any application which is not specified in this document. For other application, please be noted that a different product may be required. If you have any concerns, please contact us before using the products in your desired application. This specification guarantees the quality and performance of the products as an individual component. Do not use the products beyond the use case and use environment that the specification has described in this document. We assume no responsibility and liability for any lost and damage resulting from the use or operation of the products which do not comply with any absolute maximum ratings, warnings, restrictions and instructions recited in these specification sheets or other forms of notices from us or resulting from the use or operation of the products under non-standard environment or operations.

■ Cautions

- All measurement data is taken from standard laboratory procedures on each discrete product. The procedure does not work on any product integrating components and materials not provided by us. The measurement is provided for your reference and evaluation on your integrated products only. Therefore the products should always be cautiously used with other parts on your own. It is your or your customer's responsibility to perform sufficient tests under your expected environment prior to use the products with other parts to ensure that the lifetime and other quality characteristics required for the actual use in real life are met. During your tests, it is recommended to actively consult with us instantly while there is any concern or inconsistency about the discrete LED. Caution: While using under non-standard environment, application or non-approval operations, be aware of malfunctions or damages leads to risks of life or health.
- You will not reverse engineer, disassemble or otherwise attempt to extract knowledge/design information from the products. In the case of any incident or quality concern that appears to be in breach of these specifications, the products in question must be reported to our local sales representatives for further instructions. Please ensure that the products in question are not dissembled or removed from the PCBs(if any). The determination of whether the products in question are defective and are required for any corrective action thereafter shall be made by us in accordance with our

Precaution

PR35V30 V0

Product Specification

cause analysis procedure. If you do not agree with our cause analysis result, you may request us to send the products in question to a mutually agreed third party for inspection. The cost of such third party inspection shall be borne by you unless it is determined by such third party that said quality issue is solely attributable to us. In the above case, our sole and exclusive obligation shall be, either to repair, replace or refund the products in question.

- All previous negotiation and agreements not specifically incorporated herein are superseded and rendered null and void. We assume no liability with respect to defects and/or issues of the products caused by:
 - (a.) alternation, modification, change, repair and attempt to repair of the products by a party other than us;
 - (b.) not caused by our negligent, gross negligent, reckless, or other improper use of the LEDs;
 - (c.) installation, operation, or maintenance of the products by a party other than us and not in a manner described in the instruction manual, if applicable; and
 - (d.) combination of a product not supplied by us.

■ **DISCLAIMERS:**

- REPAIR, REPLACE OR REFUND OF THE Products SHALL CONSTITUTE THE SOLE AND EXCLUSIVE REMEDY FOR THE PRODUCTS. WE EXPRESSLY EXCLUDE ALL EXPRESS WARRANTIES IN RELATION TO THE PRODUCTS INCLUDING THE IMPLIED WARRANTIES OF MERCHANTABILITY AND FITNESS FOR A PARTICULAR PURPOSE.
- BOTH PARTIES AGREE THAT BEFORE YOUR CONSENT TO THE DOCUMENT, WE RESERVE RIGHTS TO MODIFY AND DISCARD THE FORMER VERSION OF THE DOCUMENT AND THE CONSENT IN THIS CLAUSE INCLUDING A WRITTEN COSENT OR BEGINNING AN ACTUAL PERFORMANCE ON DEALINGS.

单击下面可查看定价，库存，交付和生命周期等信息

[>>Lextar\(隆达\)](#)