

PC35H11 V3

Product Specification

Approval Sheet

PC35H11 V3
Product Specification

RoHS

Product	White SMD LED
Part Number	PC35H11 V3
Issue Date	2018/01/10



■ Feature

- ✓ White SMD LED (L x W x H) of 3.5x 2.8 x 0.7 mm
- ✓ ASNI binning
- ✓ Dice Technology : InGaN
- ✓ Qualified according to JEDEC moisture sensitivity Level 3
- ✓ Environmental friendly ; RoHS compliance
- ✓ Packing : 2000 & 4000 pcs/reel

■ Applications

- ✓ Portable flashlight
- ✓ Reading lights
- ✓ Security / garden lighting
- ✓ General lighting
- ✓ Indoor and outdoor commercial lighting

Outline Dimension

PC35H11 V3
Product Specification

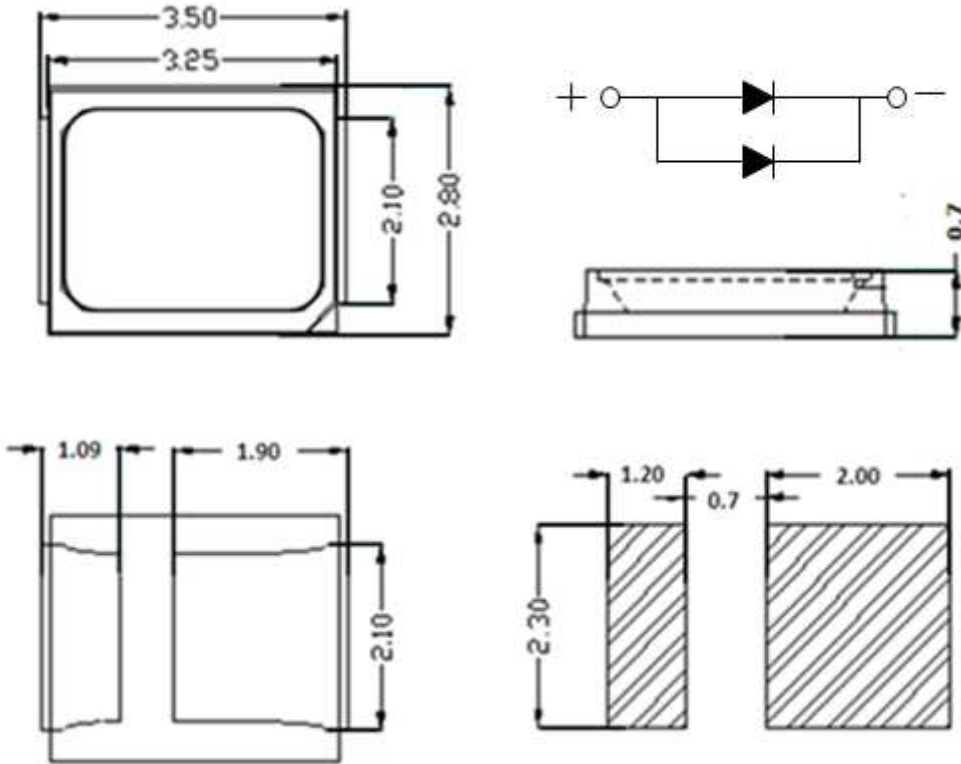

1. Unit :mm
2. Tolerance : $\pm 0.1\text{mm}$

Performance

PC35H11 V3
 Product Specification

■ **Electro-Optical Characteristics (Ta=25°C)**

Parameter	Symbol	Condition	Min.	Typ.	Max.	Unit
Forward Voltage ⁽¹⁾	V _F	I _F = 65 mA	2.7	-	2.9	V
Color Rendering Index ⁽²⁾	R _a		80	-	-	-
View Angle	θ		-	120	-	deg
Thermal Resistance ⁽³⁾	R _{th}		-	17	-	°C/W

(1) The Forward Voltage tolerance is ±0.1V

(2) The Color Rendering Index tolerance is ±2

(3) Thermal resistance is calculated from junction to solder

■ **Luminous Flux (Ta=25°C)**

CCT	Condition	Rank
2600K~3700K	I _F = 65 mA	TH, TI
3700K~7000K		TI, TJ

* The luminous flux tolerance is ± 7%

■ **Absolute Maximum Ratings**

Parameter	Symbol	value	Unit
DC Forward Current ⁽¹⁾	I _F	200	mA
Power Dissipation	P _D	0.65	W
Pulse Forward Current ⁽²⁾	I _{FP}	360	mA
Storage Temperature	T _{stg}	-40 ~ 100	°C
Operating Temperature	T _{opr}	-40 ~ 85	°C
Junction Temperature	T _J	120	°C
Assembly Temperature		260 (5 sec)	°C

(1) Proper current rating must be observed to maintain junction temperature below maximum at all time

(2) IFP Condition: Duty 1/10, Pulse within 10msec

Ordering Code

P C 3 5 H 1 1 3 - A 2 7 1 B 0 T H T I A B - 0 2 0

1	2	3	4	5	6	7	8	9	10	11	12	13	14	15	16	17	18	19	20	21	22	23
---	---	---	---	---	---	---	---	---	----	----	----	----	----	----	----	----	----	----	----	----	----	----

Item	Pos.	Code	Spec			
Model Name	1-8	PC35H113	PC35H11 V3			
CIE Center Point	9	A	ANSI 1931 on B.B.L			
CCT	10,11	27	27 = 2700K			
		30	30 = 3000K			
		35	35 = 3500K			
		40	40 = 4000K			
		50	50 = 5000K			
		57	57 = 5700K			
		65	65 = 6500K			
R9	12	1	R9 > 0			
CIE Bin Group ⁽¹⁾	13,14	A0 B0	274B,274C,275B,275C 273A~273D,274A~274D 275A~275D,276A~276D			
IV Bin Group	15,16, 17,18	TH TI	Bin code : TH Bin code : TI			
Vf Bin Group	19,20	AB	Bin code : A,B			
Kitting Rules	CIE ⁽¹⁾	21	0 1 ⁽²⁾ 2 ⁽²⁾	No requirements. 3 step Kitting 5 step Kitting		
		Others	Chip Numbers	22	2	1 : 1 chip version 2 : 2 chip version
			non	23	0	No requirements.

(1) The first two digits 27 means CCT in 2700K, can be replaced to 30, 35, 40, 50, 57, 65 for different CCT requirements.

(2) Only under an agreement between customer and Lextar Electronics, kitting rules besides "0" can be supplied.

■ **Standard Ordering Code:**

CCT	Ordering Code ⁽¹⁾	CIE Bin Group	IV Bin Group	Vf Bin Group
2700K	PC35H113-A271A0THTIAB-020	A0	TH, TI	A, B
	PC35H113-A271B0THTIAB-020	B0		
3000K	PC35H113-A301A0THTIAB-020	A0	TH, TI	A, B
	PC35H113-A301B0THTIAB-020	B0		
3500K	PC35H113-A351A0THTIAB-020	A0	TH, TI	A, B
	PC35H113-A351B0THTIAB-020	B0		
4000K	PC35H113-A401A0TITJAB-020	A0	TI, TJ	A, B
	PC35H113-A401B0TITJAB-020	B0		
5000K	PC35H113-A501A0TITJAB-020	A0	TI, TJ	A, B
	PC35H113-A501B0TITJAB-020	B0		
5700K	PC35H113-A571A0TITJAB-020	A0	TI, TJ	A, B
	PC35H113-A571B0TITJAB-020	B0		
6500K	PC35H113-A651A0TITJAB-020	A0	TI, TJ	A, B
	PC35H113-A651B0TITJAB-020	B0		

(1) Only under an agreement between customer and Lextar Electronics, Ordering codes not in “Standard Ordering Code Definitions” can be supplied.

Binning

PC35H11 V3
 Product Specification

■ Chromaticity Coordinates

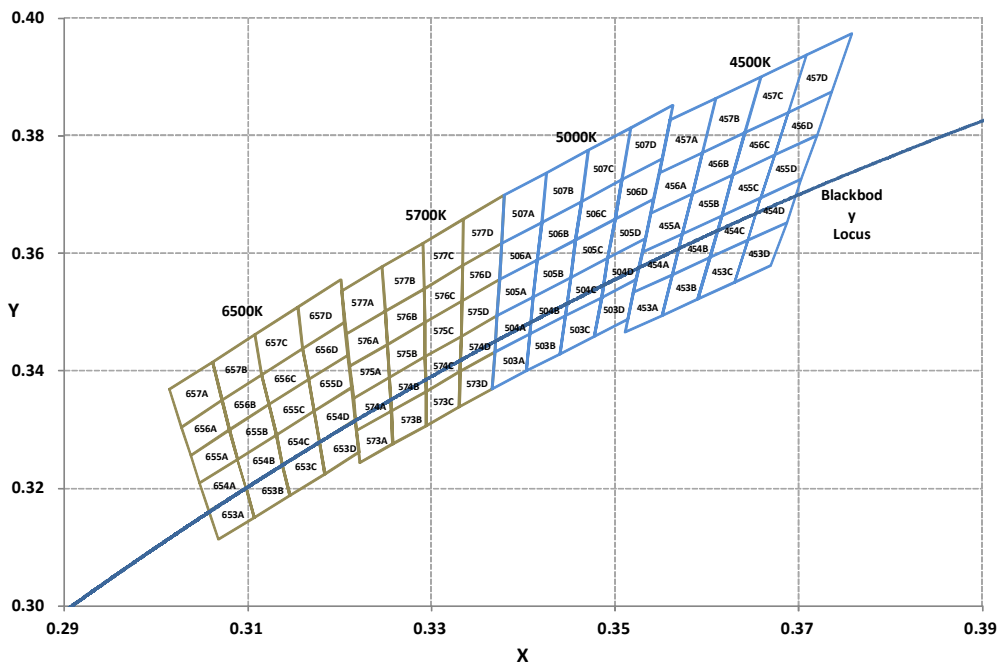
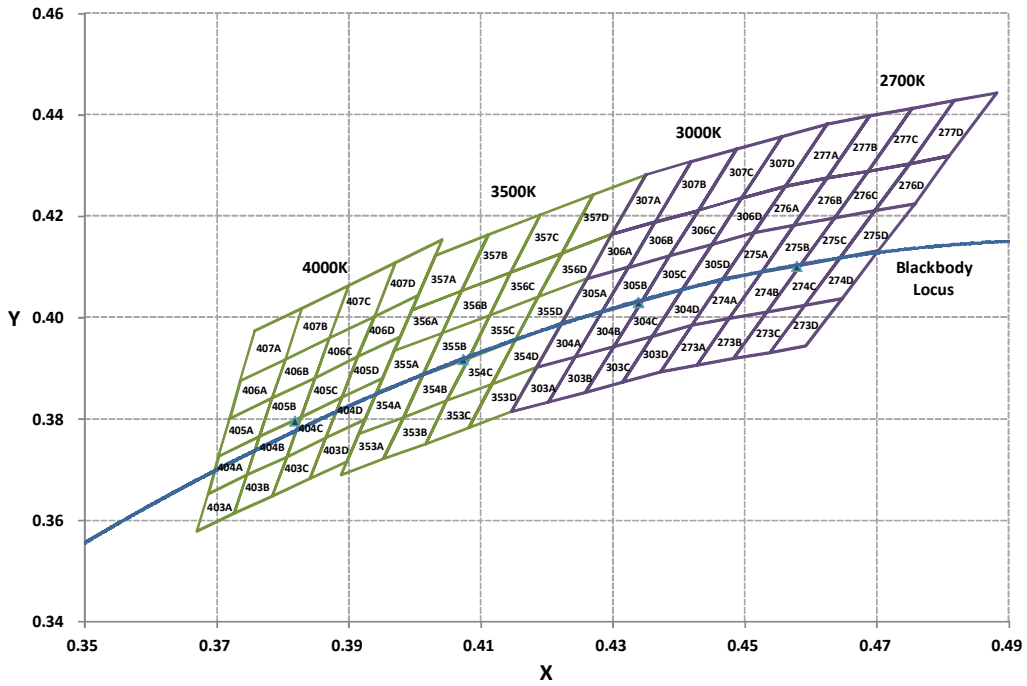

2700K						3000K					
Region	CIE x	CIE y	Region	CIE x	CIE y	Region	CIE x	CIE y	Region	CIE x	CIE y
277A	0.4562	0.4260	277C	0.4687	0.4289	307A	0.4350	0.4282	307C	0.4488	0.4332
	0.4625	0.4275		0.4750	0.4304		0.4299	0.4165		0.4430	0.4212
	0.4689	0.4398		0.4818	0.4429		0.4365	0.4189		0.4496	0.4236
	0.4625	0.4382		0.4754	0.4413		0.4419	0.4307		0.4556	0.4357
276A	0.4562	0.4260	276C	0.4636	0.4197	306A	0.4261	0.4077	306C	0.4430	0.4212
	0.4515	0.4168		0.4697	0.4211		0.4324	0.4100		0.4387	0.4122
	0.4575	0.4182		0.4750	0.4304		0.4365	0.4189		0.4451	0.4145
	0.4625	0.4275		0.4687	0.4289		0.4299	0.4165		0.4496	0.4236
275A	0.4515	0.4168	275C	0.4636	0.4197	305A	0.4261	0.4077	305C	0.4387	0.4122
	0.4468	0.4077		0.4585	0.4104		0.4223	0.3990		0.4345	0.4033
	0.4526	0.4090		0.4644	0.4118		0.4284	0.4011		0.4406	0.4055
	0.4575	0.4182		0.4697	0.4211		0.4324	0.4100		0.4451	0.4145
274A	0.4468	0.4077	274C	0.4585	0.4104	304A	0.4223	0.3990	304C	0.4345	0.4033
	0.4420	0.3985		0.4534	0.4012		0.4185	0.3902		0.4302	0.3943
	0.4477	0.3998		0.4591	0.4025		0.4243	0.3922		0.4361	0.3964
	0.4526	0.4090		0.4644	0.4118		0.4284	0.4011		0.4406	0.4055
273A	0.4420	0.3985	273C	0.4534	0.4012	303A	0.4243	0.3922	303C	0.4302	0.3943
	0.4373	0.3893		0.4483	0.3919		0.4203	0.3834		0.4259	0.3853
	0.4428	0.3906		0.4538	0.3932		0.4147	0.3814		0.4316	0.3873
	0.4477	0.3998		0.4591	0.4025		0.4185	0.3902		0.4361	0.3964
277B	0.4625	0.4275	277D	0.4750	0.4304	307B	0.4419	0.4307	307D	0.4556	0.4357
	0.4687	0.4289		0.4810	0.4319		0.4365	0.4189		0.4496	0.4236
	0.4754	0.4413		0.4882	0.4444		0.4430	0.4212		0.4562	0.4260
	0.4689	0.4398		0.4818	0.4429		0.4488	0.4332		0.4625	0.4382
276B	0.4575	0.4182	276D	0.4697	0.4211	306B	0.4324	0.4099	306D	0.4496	0.4236
	0.4636	0.4197		0.4758	0.4225		0.4387	0.4122		0.4451	0.4145
	0.4687	0.4289		0.4810	0.4319		0.4430	0.4212		0.4514	0.4168
	0.4625	0.4275		0.4750	0.4304		0.4364	0.4188		0.4562	0.4260
275B	0.4575	0.4182	275D	0.4697	0.4211	305B	0.4324	0.4100	305D	0.4451	0.4145
	0.4526	0.4090		0.4644	0.4118		0.4284	0.4011		0.4406	0.4055
	0.4585	0.4104		0.4703	0.4132		0.4345	0.4033		0.4468	0.4077
	0.4636	0.4197		0.4758	0.4225		0.4387	0.4122		0.4515	0.4168
274B	0.4526	0.4090	274D	0.4644	0.4118	304B	0.4284	0.4011	304D	0.4406	0.4055
	0.4477	0.3998		0.4591	0.4025		0.4243	0.3922		0.4361	0.3964
	0.4534	0.4012		0.4648	0.4038		0.4302	0.3943		0.4420	0.3985
	0.4585	0.4104		0.4703	0.4132		0.4345	0.4033		0.4468	0.4077
273B	0.4477	0.3998	273D	0.4591	0.4025	303B	0.4302	0.3943	303D	0.4361	0.3964
	0.4428	0.3906		0.4538	0.3932		0.4259	0.3853		0.4316	0.3873
	0.4483	0.3919		0.4593	0.3944		0.4203	0.3834		0.4373	0.3893
	0.4534	0.4012		0.4648	0.4038		0.4243	0.3922		0.4420	0.3985

3500K						4000K					
Region	CIE x	CIE y	Region	CIE x	CIE y	Region	CIE x	CIE y	Region	CIE x	CIE y
357A	0.4032	0.4123	357C	0.4191	0.4203	407A	0.3758	0.3973	407C	0.3900	0.4063
	0.3996	0.4015		0.4146	0.4089		0.3829	0.4018		0.3971	0.4108
	0.4071	0.4052		0.4223	0.4127		0.3804	0.3917		0.3939	0.4002
	0.4112	0.4163		0.4271	0.4242		0.3736	0.3874		0.3871	0.3959
356A	0.3996	0.4015	356C	0.4146	0.4089	406A	0.3736	0.3874	406C	0.3871	0.3959
	0.3969	0.3934		0.4114	0.4005		0.3720	0.3800		0.3849	0.3881
	0.4042	0.3969		0.4187	0.4041		0.3784	0.3841		0.3914	0.3922
	0.4071	0.4052		0.4223	0.4127		0.3804	0.3917		0.3939	0.4002
355A	0.3969	0.3934	355C	0.4114	0.4005	405A	0.3720	0.3800	405C	0.3849	0.3881
	0.3943	0.3853		0.4082	0.3920		0.3703	0.3726		0.3828	0.3803
	0.4012	0.3886		0.4152	0.3955		0.3765	0.3765		0.3890	0.3842
	0.4042	0.3969		0.4187	0.4041		0.3784	0.3841		0.3914	0.3922
354A	0.3943	0.3853	354C	0.4082	0.3920	404A	0.3703	0.3726	404C	0.3828	0.3803
	0.3916	0.3771		0.4049	0.3836		0.3687	0.3652		0.3806	0.3725
	0.3983	0.3803		0.4117	0.3869		0.3746	0.3689		0.3865	0.3762
	0.4012	0.3886		0.4152	0.3955		0.3765	0.3765		0.3890	0.3842
353A	0.3916	0.3771	353C	0.4049	0.3836	403A	0.3687	0.3652	403C	0.3806	0.3725
	0.3889	0.3690		0.4017	0.3751		0.3670	0.3578		0.3784	0.3647
	0.3953	0.3721		0.4082	0.3783		0.3727	0.3613		0.3841	0.3682
	0.3983	0.3803		0.4117	0.3869		0.3746	0.3689		0.3865	0.3762
357B	0.4112	0.4163	357D	0.4271	0.4242	407B	0.3829	0.4018	407D	0.3971	0.4108
	0.4071	0.4052		0.4223	0.4127		0.3900	0.4063		0.4042	0.4153
	0.4146	0.4089		0.4299	0.4165		0.3871	0.3959		0.4006	0.4044
	0.4191	0.4203		0.4350	0.4282		0.3804	0.3917		0.3939	0.4002
356B	0.4071	0.4052	356D	0.4223	0.4127	406B	0.3804	0.3917	406D	0.3939	0.4002
	0.4042	0.3969		0.4187	0.4041		0.3784	0.3841		0.3914	0.3922
	0.4114	0.4005		0.4261	0.4077		0.3849	0.3881		0.3979	0.3962
	0.4146	0.4089		0.4299	0.4165		0.3871	0.3959		0.4006	0.4044
355B	0.4042	0.3969	355D	0.4187	0.4041	405B	0.3784	0.3841	405D	0.3914	0.3922
	0.4012	0.3886		0.4152	0.3955		0.3765	0.3765		0.3890	0.3842
	0.4082	0.3920		0.4223	0.3990		0.3828	0.3803		0.3952	0.3880
	0.4114	0.4005		0.4261	0.4077		0.3849	0.3881		0.3979	0.3962
354B	0.4012	0.3886	354D	0.4152	0.3955	404B	0.3765	0.3765	404D	0.3890	0.3842
	0.3983	0.3803		0.4117	0.3869		0.3746	0.3689		0.3865	0.3762
	0.4049	0.3836		0.4185	0.3902		0.3806	0.3725		0.3925	0.3798
	0.4082	0.3920		0.4223	0.3990		0.3828	0.3803		0.3952	0.3880
353B	0.3983	0.3803	353D	0.4117	0.3869	403B	0.3746	0.3689	403D	0.3865	0.3762
	0.3953	0.3721		0.4082	0.3783		0.3727	0.3613		0.3841	0.3682
	0.4017	0.3751		0.4147	0.3814		0.3784	0.3647		0.3898	0.3716
	0.4049	0.3836		0.4185	0.3902		0.3806	0.3725		0.3925	0.3798

4500K						5000K					
Region	CIE x	CIE y	Region	CIE x	CIE y	Region	CIE x	CIE y	Region	CIE x	CIE y
457A	0.3560	0.3826	457C	0.3659	0.3900	507A	0.3379	0.3698	507C	0.3471	0.3775
	0.3610	0.3863		0.3709	0.3936		0.3425	0.3736		0.3517	0.3813
	0.3595	0.3770		0.3689	0.3839		0.3420	0.3652		0.3507	0.3724
	0.3548	0.3736		0.3641	0.3804		0.3376	0.3616		0.3463	0.3687
456A	0.3548	0.3736	456C	0.3641	0.3804	506A	0.3376	0.3616	506C	0.3463	0.3687
	0.3539	0.3668		0.3628	0.3733		0.3374	0.3554		0.3457	0.3622
	0.3584	0.3701		0.3674	0.3767		0.3415	0.3588		0.3500	0.3657
	0.3595	0.3770		0.3689	0.3839		0.3420	0.3652		0.3507	0.3724
455A	0.3539	0.3668	455C	0.3628	0.3733	505A	0.3374	0.3554	505C	0.3457	0.3622
	0.3530	0.3601		0.3616	0.3663		0.3371	0.3493		0.3452	0.3558
	0.3573	0.3632		0.3659	0.3694		0.3411	0.3525		0.3492	0.3591
	0.3584	0.3701		0.3674	0.3767		0.3415	0.3588		0.3500	0.3657
454A	0.3530	0.3601	454C	0.3616	0.3663	504A	0.3371	0.3493	504C	0.3452	0.3558
	0.3520	0.3533		0.3603	0.3592		0.3369	0.3431		0.3446	0.3493
	0.3562	0.3562		0.3645	0.3622		0.3407	0.3462		0.3485	0.3524
	0.3573	0.3632		0.3659	0.3694		0.3411	0.3525		0.3492	0.3591
453A	0.3520	0.3533	453C	0.3603	0.3592	503A	0.3369	0.3431	503C	0.3446	0.3493
	0.3511	0.3465		0.3590	0.3521		0.3366	0.3369		0.3440	0.3428
	0.3551	0.3493		0.3630	0.3550		0.3403	0.3399		0.3477	0.3458
	0.3562	0.3562		0.3645	0.3622		0.3407	0.3462		0.3485	0.3524
457B	0.3610	0.3863	457D	0.3709	0.3936	507B	0.3425	0.3736	507D	0.3517	0.3813
	0.3659	0.3900		0.3758	0.3973		0.3471	0.3775		0.3563	0.3851
	0.3641	0.3804		0.3736	0.3874		0.3463	0.3687		0.3551	0.3760
	0.3595	0.3770		0.3689	0.3839		0.3420	0.3652		0.3507	0.3724
456B	0.3595	0.3770	456D	0.3689	0.3839	506B	0.3420	0.3652	506D	0.3507	0.3724
	0.3584	0.3701		0.3674	0.3767		0.3415	0.3588		0.3500	0.3657
	0.3628	0.3733		0.3720	0.3800		0.3457	0.3622		0.3542	0.3692
	0.3641	0.3804		0.3736	0.3874		0.3463	0.3687		0.3551	0.3760
455B	0.3584	0.3701	455D	0.3674	0.3767	505B	0.3415	0.3588	505D	0.3500	0.3657
	0.3573	0.3632		0.3659	0.3694		0.3411	0.3525		0.3492	0.3591
	0.3616	0.3663		0.3703	0.3726		0.3452	0.3558		0.3533	0.3624
	0.3628	0.3733		0.3720	0.3800		0.3457	0.3622		0.3542	0.3692
454B	0.3573	0.3632	454D	0.3659	0.3694	504B	0.3411	0.3525	504D	0.3492	0.3591
	0.3562	0.3562		0.3645	0.3622		0.3407	0.3462		0.3485	0.3524
	0.3603	0.3592		0.3687	0.3652		0.3446	0.3493		0.3523	0.3555
	0.3616	0.3663		0.3703	0.3726		0.3452	0.3558		0.3533	0.3624
453B	0.3562	0.3562	453D	0.3645	0.3622	503B	0.3407	0.3462	503D	0.3485	0.3524
	0.3551	0.3493		0.3630	0.3550		0.3403	0.3399		0.3477	0.3458
	0.3590	0.3521		0.3670	0.3578		0.3440	0.3428		0.3514	0.3487
	0.3603	0.3592		0.3687	0.3652		0.3446	0.3493		0.3523	0.3555

5700K						6500K					
Region	CIE x	CIE y	Region	CIE x	CIE y	Region	CIE x	CIE y	Region	CIE x	CIE y
577A	0.3202	0.3535	577C	0.3291	0.3617	657A	0.3015	0.3368	657C	0.3108	0.3461
	0.3246	0.3576		0.3335	0.3657		0.3062	0.3415		0.3155	0.3508
	0.3250	0.3501		0.3334	0.3578		0.3072	0.3349		0.3160	0.3437
	0.3207	0.3462		0.3292	0.3539		0.3028	0.3304		0.3115	0.3393
576A	0.3207	0.3462	576C	0.3292	0.3539	656A	0.3028	0.3304	656C	0.3115	0.3393
	0.3211	0.3407		0.3293	0.3481		0.3038	0.3256		0.3123	0.3342
	0.3252	0.3444		0.3333	0.3518		0.3080	0.3299		0.3166	0.3384
	0.3250	0.3501		0.3334	0.3578		0.3072	0.3349		0.3160	0.3437
575A	0.3211	0.3407	575C	0.3293	0.3481	655A	0.3038	0.3256	655C	0.3123	0.3342
	0.3215	0.3353		0.3293	0.3423		0.3048	0.3209		0.3131	0.3290
	0.3254	0.3388		0.3332	0.3458		0.3089	0.3249		0.3172	0.3331
	0.3252	0.3444		0.3333	0.3518		0.3080	0.3299		0.3166	0.3384
574A	0.3215	0.3353	574C	0.3293	0.3423	654A	0.3048	0.3209	654C	0.3131	0.3290
	0.3218	0.3298		0.3294	0.3364		0.3058	0.3161		0.3138	0.3239
	0.3256	0.3331		0.3331	0.3398		0.3098	0.3200		0.3178	0.3277
	0.3254	0.3388		0.3332	0.3458		0.3089	0.3249		0.3172	0.3331
573A	0.3218	0.3298	573C	0.3294	0.3364	653A	0.3058	0.3161	653C	0.3138	0.3239
	0.3222	0.3243		0.3294	0.3306		0.3068	0.3113		0.3146	0.3187
	0.3258	0.3275		0.3330	0.3338		0.3107	0.3150		0.3184	0.3224
	0.3256	0.3331		0.3331	0.3398		0.3098	0.3200		0.3178	0.3277
577B	0.3246	0.3576	577D	0.3335	0.3657	657B	0.3062	0.3415	657D	0.3155	0.3508
	0.3291	0.3617		0.3379	0.3698		0.3108	0.3461		0.3201	0.3554
	0.3292	0.3539		0.3376	0.3616		0.3115	0.3393		0.3205	0.3481
	0.3250	0.3501		0.3334	0.3578		0.3072	0.3349		0.3160	0.3437
576B	0.3250	0.3501	576D	0.3334	0.3578	656B	0.3072	0.3349	656D	0.3160	0.3437
	0.3252	0.3444		0.3333	0.3518		0.3080	0.3299		0.3166	0.3384
	0.3293	0.3481		0.3374	0.3554		0.3123	0.3342		0.3209	0.3426
	0.3292	0.3539		0.3376	0.3616		0.3115	0.3393		0.3205	0.3481
575B	0.3252	0.3444	575D	0.3333	0.3518	655B	0.3080	0.3299	655D	0.3166	0.3384
	0.3254	0.3388		0.3332	0.3458		0.3089	0.3249		0.3172	0.3331
	0.3293	0.3423		0.3371	0.3493		0.3131	0.3290		0.3213	0.3371
	0.3293	0.3481		0.3374	0.3554		0.3123	0.3342		0.3209	0.3426
574B	0.3254	0.3388	574D	0.3332	0.3458	654B	0.3089	0.3249	654D	0.3172	0.3331
	0.3256	0.3331		0.3331	0.3398		0.3098	0.3200		0.3178	0.3277
	0.3294	0.3364		0.3369	0.3431		0.3138	0.3239		0.3217	0.3316
	0.3293	0.3423		0.3371	0.3493		0.3131	0.3290		0.3213	0.3371
573B	0.3256	0.3331	573D	0.3331	0.3398	653B	0.3098	0.3200	653D	0.3178	0.3277
	0.3258	0.3275		0.3330	0.3338		0.3107	0.3150		0.3184	0.3224
	0.3294	0.3306		0.3366	0.3369		0.3146	0.3187		0.3221	0.3261
	0.3294	0.3364		0.3369	0.3431		0.3138	0.3239		0.3217	0.3316

Note:

- (1) Correlated color temperature is derived from the CIE 1931 chromaticity diagram
- (2) CIE measurement tolerance is ± 0.005

■ **Bin code definition**

V_F Rank	Luminous Flux Rank	CIE Rank
A	TH	277A

Parameter	Unit	BIN	65mA	
			Min.	Max.
Forward Voltage	V	A	2.7	2.8
		B	2.8	2.9
		C	2.9	3.0
		D	3.0	3.1
		E	3.1	3.2

Parameter	Unit	BIN	65mA		Calculated Value at 150mA	
			Min.	Max.	Min.	Max.
Luminous Flux	lm	TH	30	32	66	70
		TI	32	34	70	75
		TJ	34	36	75	80
		TK	36	38	80	85

Note:

- (1) The luminous flux tolerance is $\pm 7\%$
- (2) The Forward Voltage tolerance is $\pm 0.1V$

Characteristics

PC35H11 V3
Product Specification

Spectrum

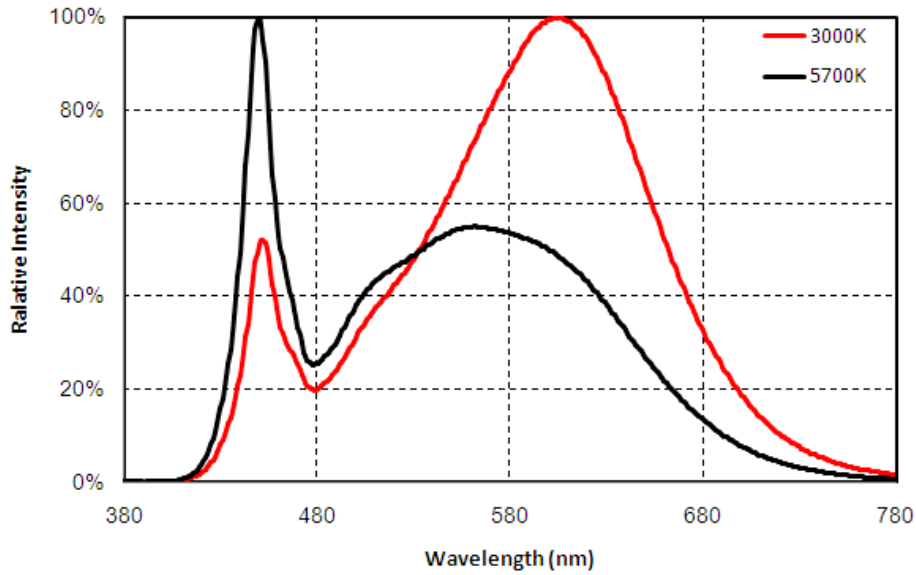

Radiation Pattern

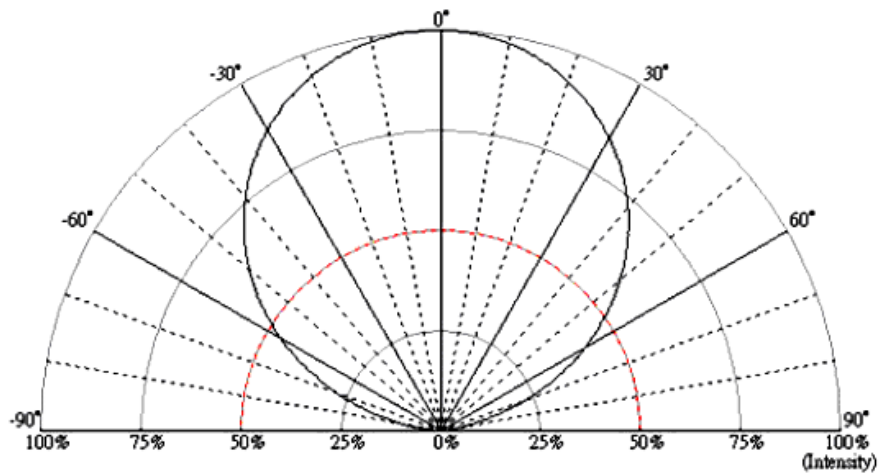

■ **Forward Voltage vs. Forward Current**

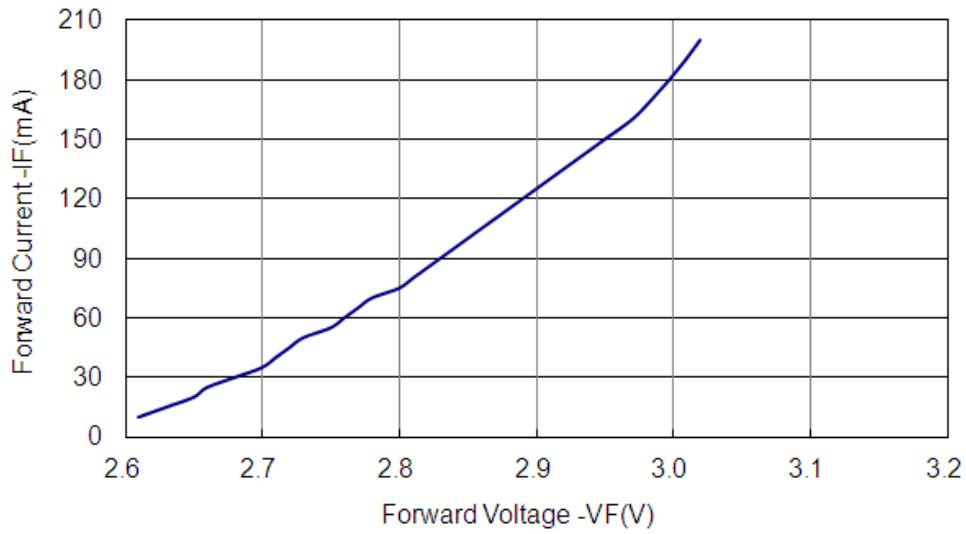

■ **Forward Current vs. Relative Luminosity**

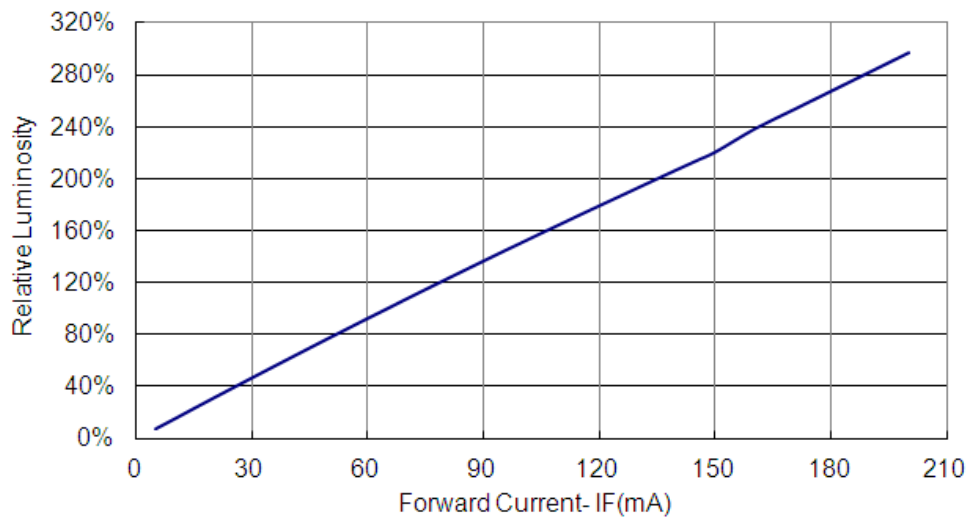

■ **Forward Current vs. Chromaticity Coordinate**

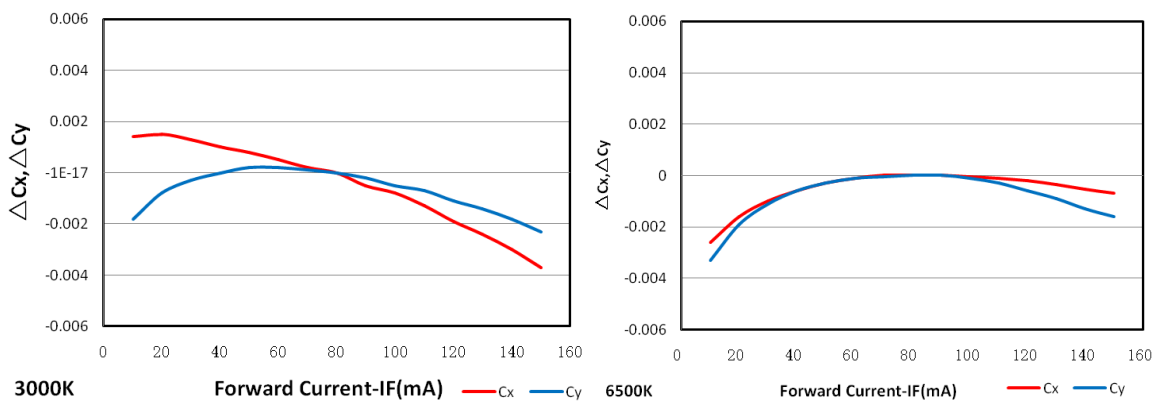

■ **Relative Luminous Intensity vs. Ambient Temperature**

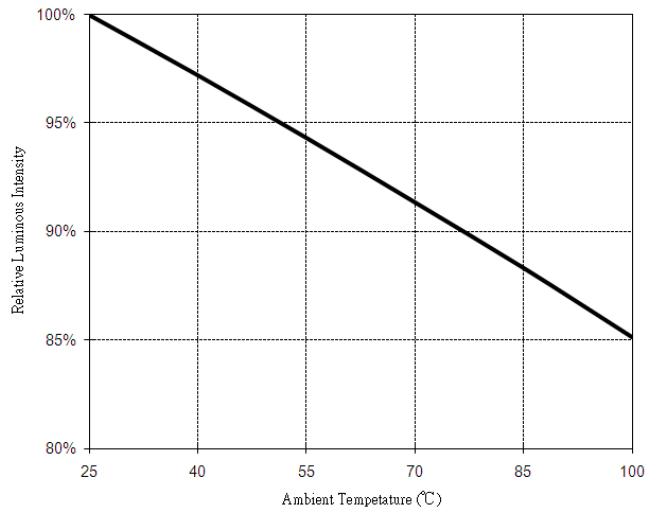

■ **Chromaticity vs. Ambient Temperature**

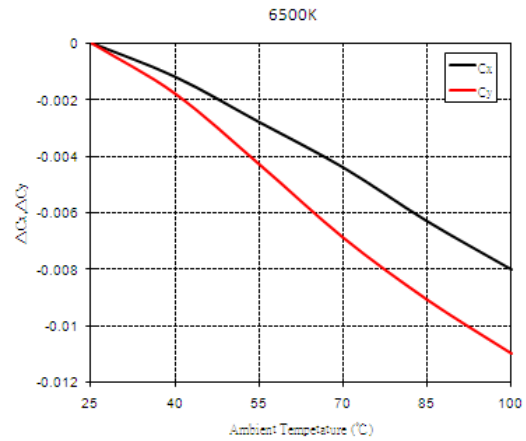
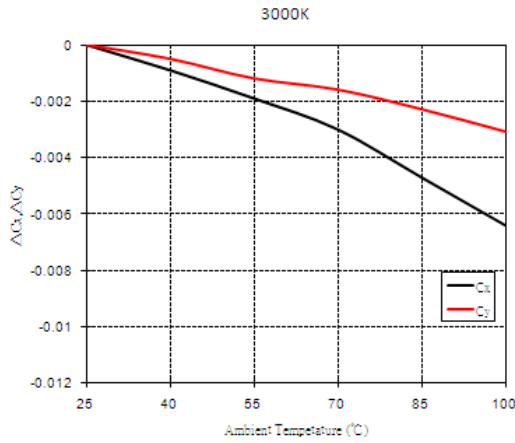

■ **Relative VF vs. Ambient Temperature**

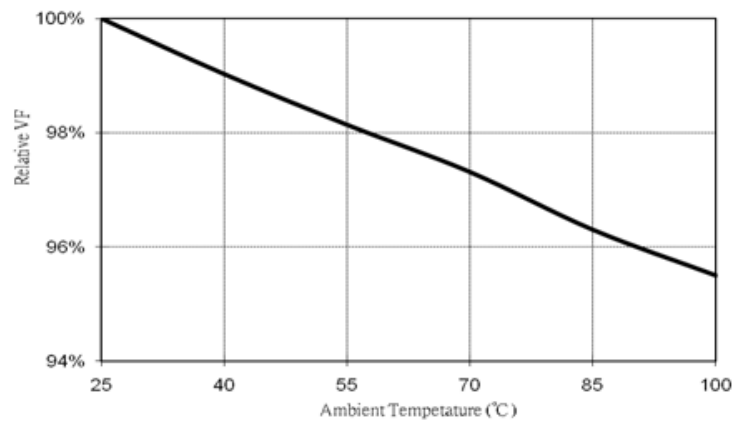

Reliability

PC35H11 V3
 Product Specification

Reliability test

Item	Condition	Time/Cycle	Sample Size
Steady State Operating Life of Low Temperature -40°C	-40°C Operating	1000 Hrs	30PCS
Steady State Operating Life of High Temperature 60°C	60°C Operating	1000 Hrs	30PCS
Steady State Operating Life of High Temperature Ts105°C	Ts 105 °C Operating	1000 Hrs	30PCS
Low temperature storage -40°C	-40°C Storage	1000 Hrs	30PCS
High temperature storage 100°C	100°C Storage	1000 Hrs	30PCS
Steady State Operating Life of High Humidity Heat 60°C90%	60°C/90% Operating	1000 Hrs	30PCS
Resistance to soldering heat on PCB (JEDEC MSL3)	pre-store@60°C, 60%RH for 52hrs Tslid max.=260°C 10sec	1 cycle 3 Times	30PCS
Thermal shock	-40°C/20minr ~5minr ~ 100°C/20min	200 Cycles	30PCS

Judgment Criteria

Item	Symbol	Test Condition	Judgment Criteria
Forward Voltage	Vf	150mA	$\Delta V_f < 10 \%$
Luminous Flux	Iv	150mA	$\Delta I_v < 30 \%$

Packing

PC35H11 V3

Product Specification

Label

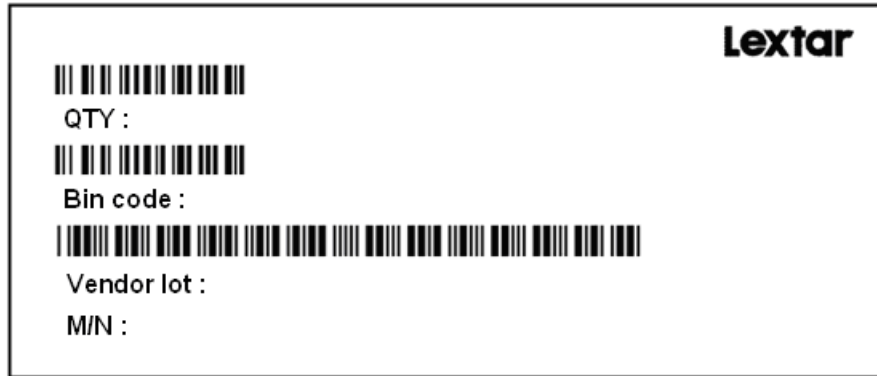

Carrier Taping

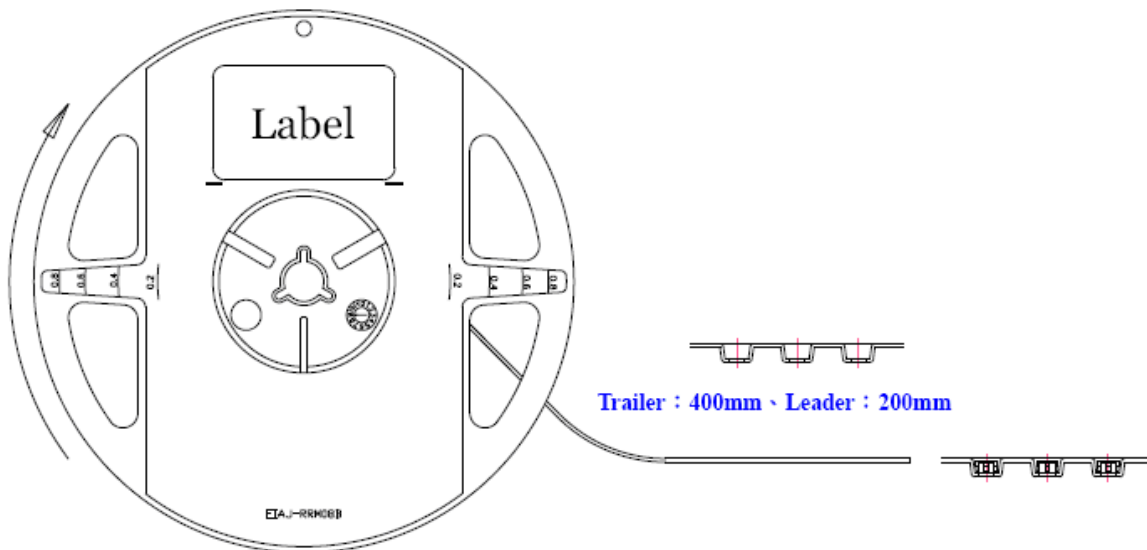

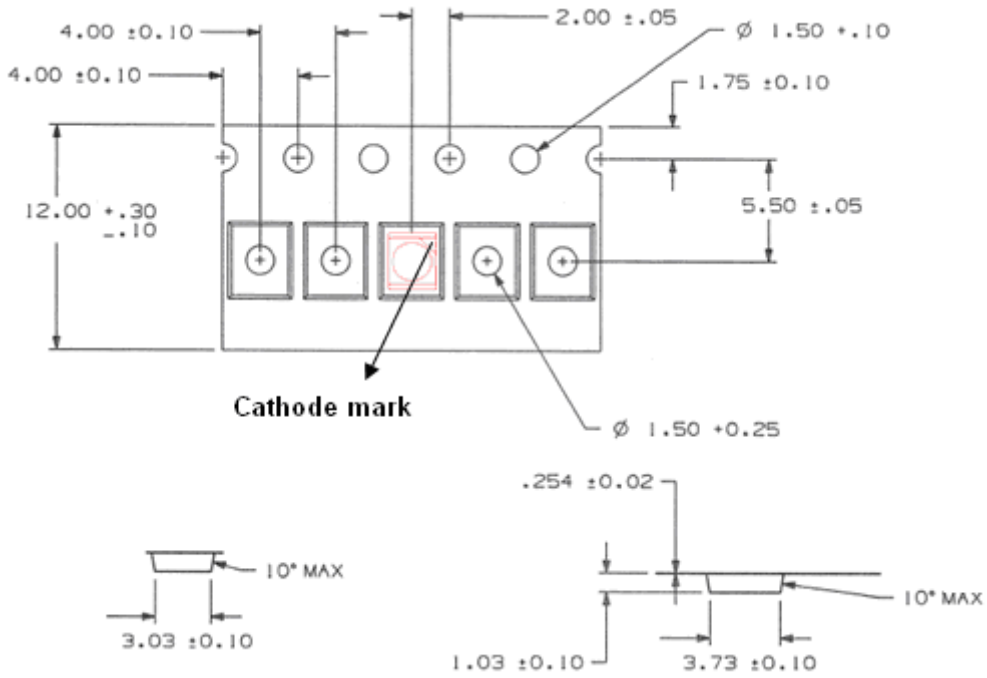

■ **Shield Bag Taping**

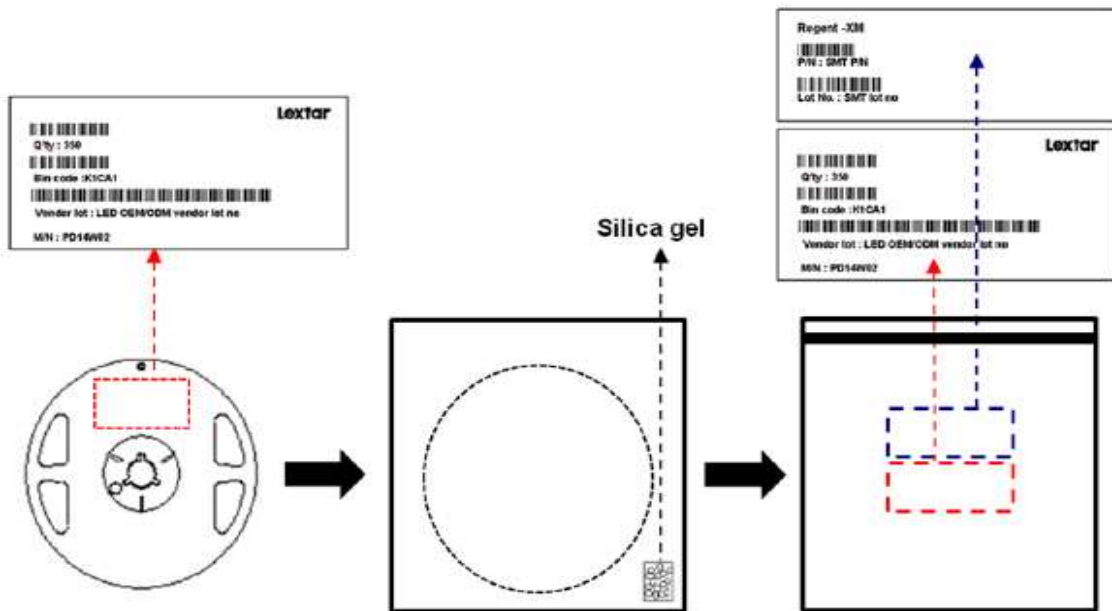

■ **Packing Box**

Type	Large Box		Medium Box		Small Box	
Dimension	541X511X276mm		385X303X260mm		283X235x70mm	
Maximum Reels	7"X12mm Reel	64/R	7"X12mm Reel	21/R	7"X12mm Reel	4/R
Minimum Reels	7"X12mm Reel	32/R	7"X12mm Reel	9/R	7"X12mm Reel	1/R

■ **Small Box**

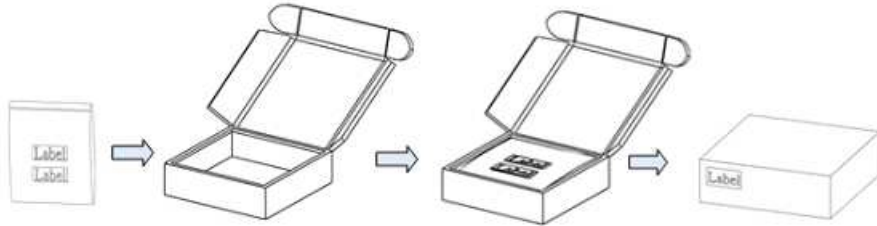

■ **Medium Box**

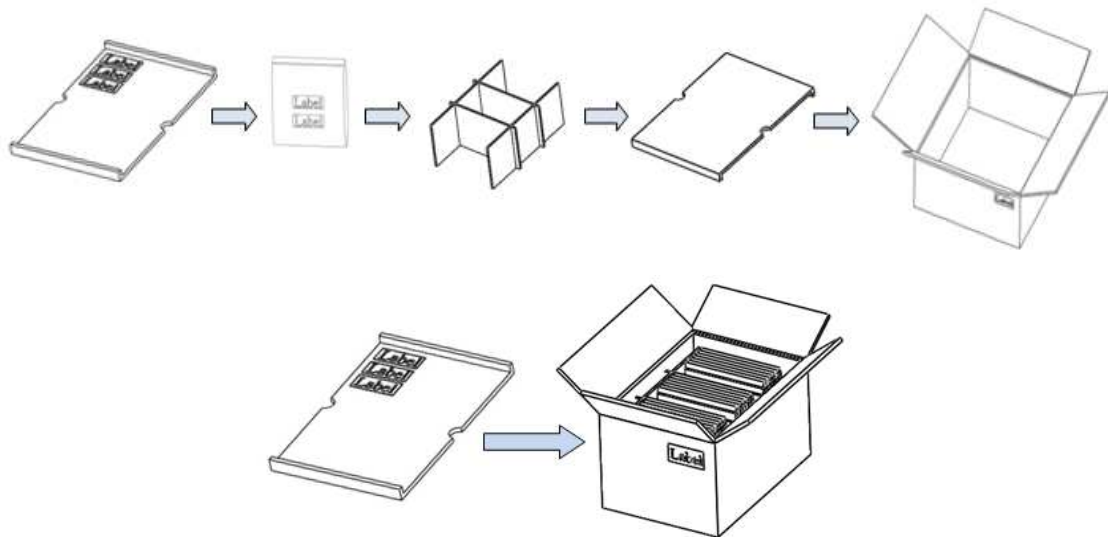

■ **Large Box**

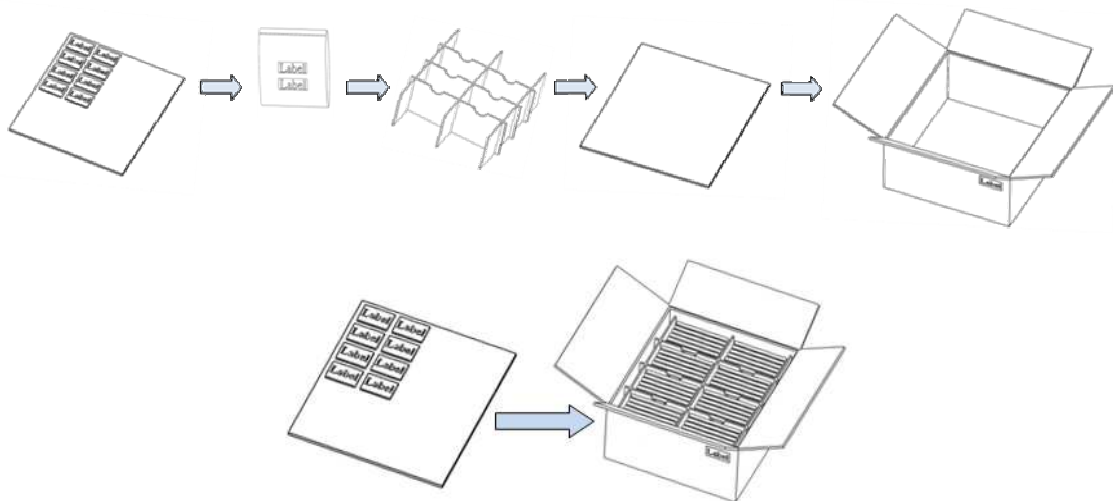

Precautions

PC35H11 V3
Product Specification

■ Safety Precautions

- The LED light output is too strong for human eyes without shield. Prevent eye contact directly more than seconds.
- Ensure operating under maximum rating.

■ Storage

- Before opening the package, the LEDs should storage under 30°C, 60% RH.
- After opening the package bag, the LEDs should be keep under 30°C, 60% RH. Recommend to use within 168hrs. If unused LEDs remain, suggest to store into moisture proof bag or original package bag with moisture absorbent material such as silica gel. Reseal well is necessary.
- If the product exceeded the storage period or the moisture absorbent material faded away, baking treatment should be done by following conditions.
Bake condition: 60°C, 12hours (One time only).

■ Soldering Notice and Conditions

- When soldering LEDs,
- Do not solder/reflow the same LED over two times.
- Recommend soldering conditions:
Hand soldering: 350 °C max , 3 sec. max.
Reflow soldering: Pre-heat 180 °C max , 180 sec. max.
Peak 260 °C max , 5 sec. max.
- Reflow temperature profile as below: (lead-free solder)

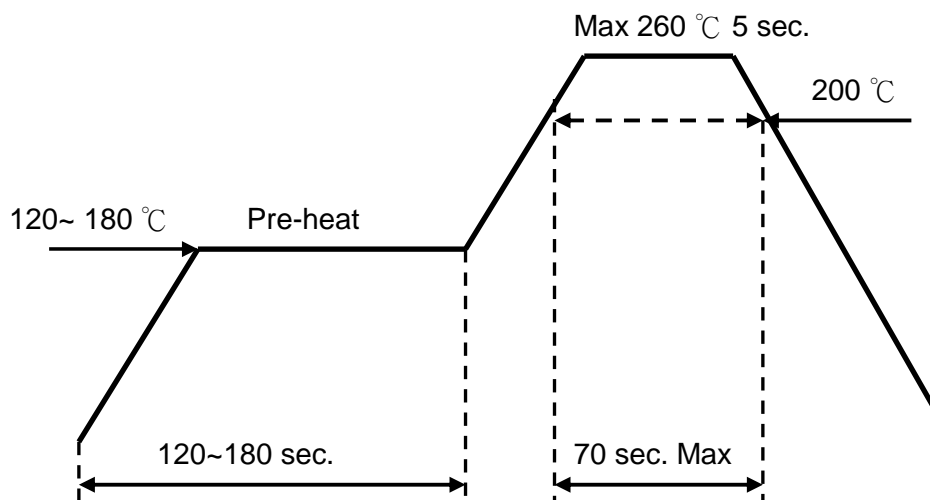

- When soldering, don't put stress on the LEDs
- After LEDs have been soldered, strongly recommend not to repair to keep the LEDs performance.

■ Static Electricity

- LED package is extremely sensitive to static electricity. It's recommended that anti-electrostatic glove and wrist band is necessary when handling the LEDs. All devices are also be grounded properly as well.
- Protection devices design should be considered in the LED driving circuit.

■ Cleaning

- If washing is required, recommend to use alcohol as a solvent.
- Recommend to avoid cleaning the LEDs by ultrasonic. If necessary, pre-test the LED is necessary to confirm whether any damage occur after the process.

Revision History

PC35H11 V3
Product Specification

Date	Contents	Writer
2017.03.20	New Version	Kenis Hung
2017.09.09	Revise IV rank	Josh Yang
2017.11.06	Revise IV rank	Josh Yang
2018.01.03	Add calculated Flux Value at 150mA	Josh Yang
2018.01.10	Modify ordering code	Josh Yang

Smart Lighting Amazing Life

Lextar Electronics Corp. is the leading LED (Light Emitting Diode) maker integrating upper stream epitaxial, middle stream chip, and downstream package, SMT and LED lighting applications. Founded in May, 2008, Lextar is a subsidiary of AU Optronics, the leading TFT-LCD and solar PV manufacturer. Lextar's product applications include lighting and LCD backlight. Lextar's manufacturing sites include Hsinchu and Chunan in Taiwan, and Suzhou in China.

The company turnover in 2012 is 340 million USD

单击下面可查看定价，库存，交付和生命周期等信息

[>>Lextar\(隆达\)](#)