

GSM+LTE MIMO Combination Antenna Screw Mount

AN_GSM_046_MIMO

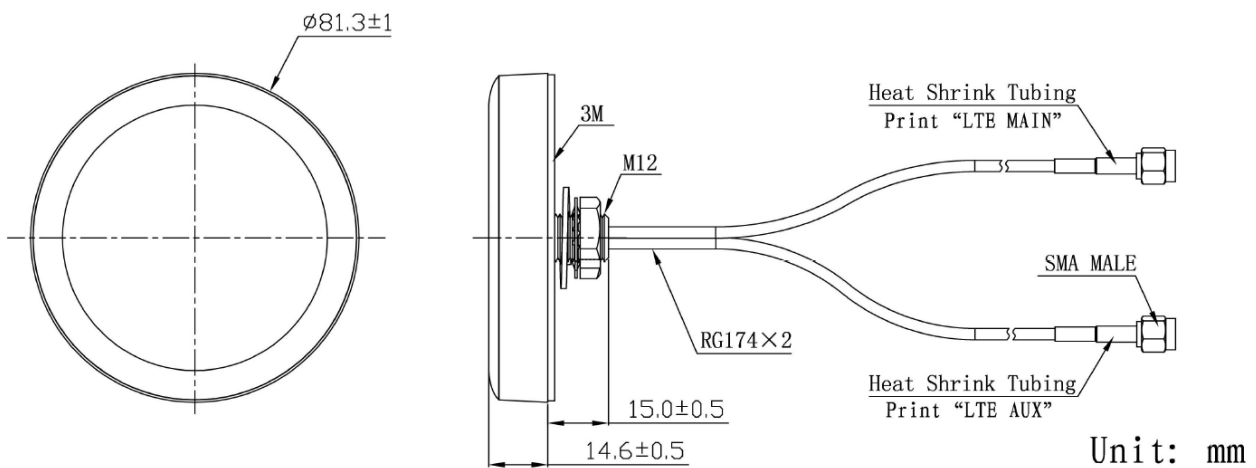

Mechanical dimension



GSM+LTE MIMO Combination Antenna Screw Mount

Specifications

Item	Specifications	
4G LTE Antenna MAIN	Frequency Range	698~960MHz/1710~2690MHz
	V.S.W.R	<3.0
	Polarization	Linear
	Gain	2.5dBi (Zenith)
	Impedance	50Ω
4G LTE Antenna AUX	Frequency Range	698~960MHz/1710~2690MHz
	V.S.W.R	<3.0
	Polarization	Linear
	Gain	2.0dBi (Zenith)
	Impedance	50Ω
Mechanical	Cable	RG174
	Connector	SMA or others
	Material	ABS
	Mounting Method	Screw
Environmental	Operating Temperature	-40°C ~ +85°C
	Relative Humidity	Up to 95%
	Ingress Protection	IP67(exclude cable outlet)
	Vibration	10 to 55Hz with 1.5mm amplitude 2hours
	Environmentally Friendly	ROHS Compliant

GSM+LTE MIMO Combination Antenna Screw Mount

Radiation Patterns

GPS Antenna Part Pattern

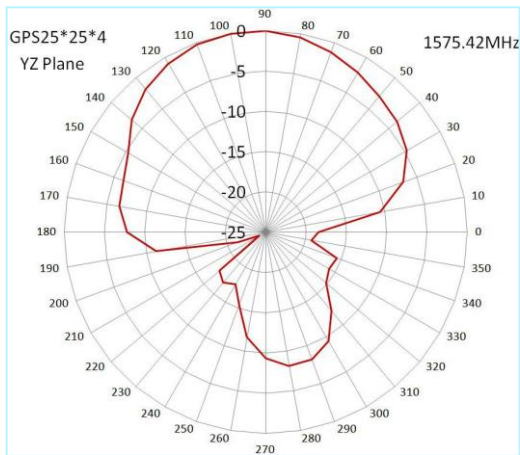
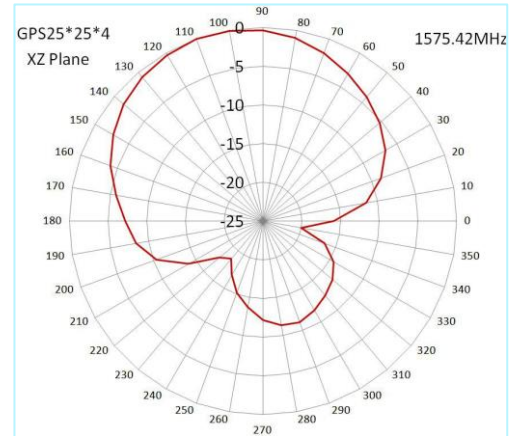
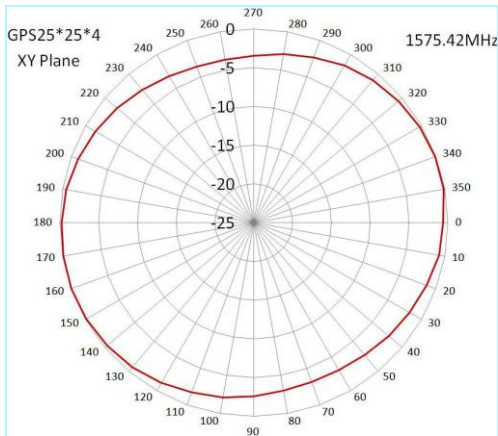

GSM+LTE MIMO Combination Antenna Screw Mount

Radiation Patterns

LTE Antenna MAIN part Pattern

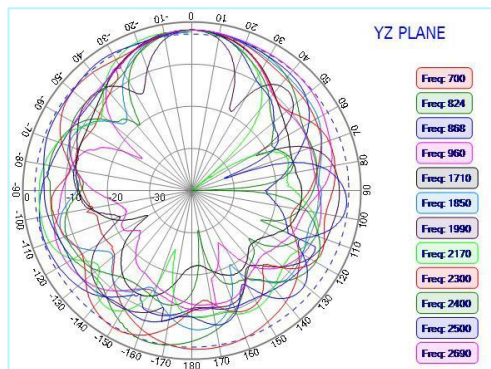
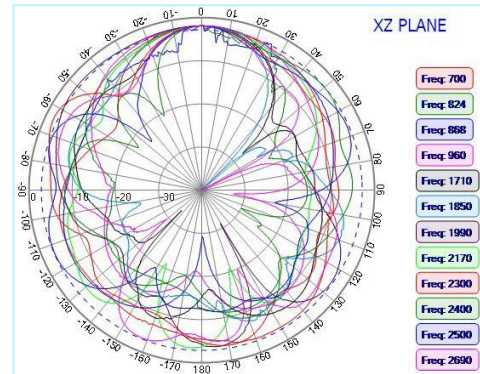
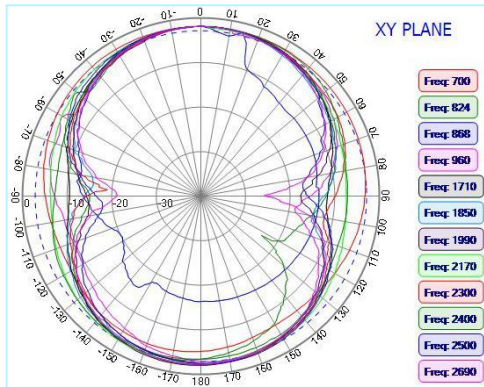

GSM+LTE MIMO Combination Antenna Screw Mount

Radiation Patterns

LTE Antenna AUX part Pattern

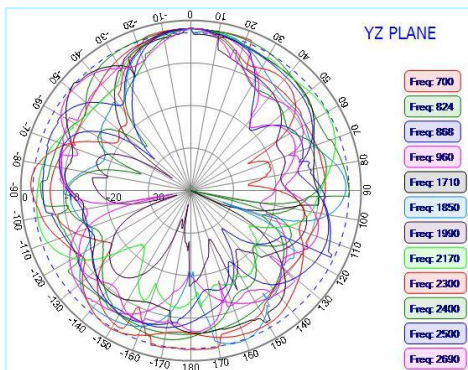
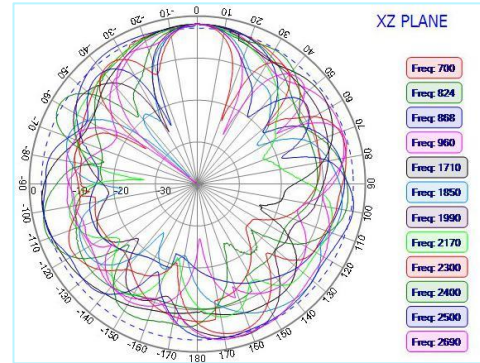
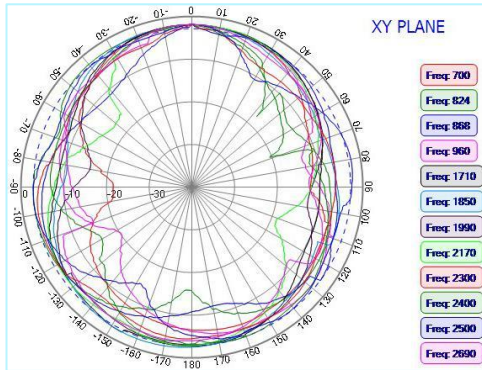

单击下面可查看定价，库存，交付和生命周期等信息

[>>Maswell\(迈斯维\)](#)