



Approval Sheet

Customer Information

Customer		
Part Name		
Part No.		
Model No.		
COMPANY	PURCHASE	R&D

Vendor Information

Name	SFI Electronics Technology Inc.
Part Name	Chip Surge Protection Device (CSPD) Series
Part No.	Super High Current (SHC) Series
Lot No.	

SFI Electronics Technology Inc.

ADDRESS : No.6, Lane 340, Shan-Ying Road, Guishan, Tao Yuan, Taiwan

TEL : 886-3-3506998 FAX : 886-3-3507689 E-mail : sfi@sfi.com.tw

Quality Control	Document Control	Business Issue	
 <p>ISO 9001:2008 ISO 14001:2004 ISO/TS 16949:2009 Management System www.tuv.com ID 1100008833</p>	REV : G	Prepared	Check
			

Part No.	SHC Series	Document No.	AS-RDSHC-S01	REV.	G
http://www.sfi.com.tw E-mail : sfi@sfi.com.tw TEL : 886-3-3506998 FAX : 886-3-3507689 - 1 -					



1. Part Number Identification

SFI 2220 SC 750 – 302 A

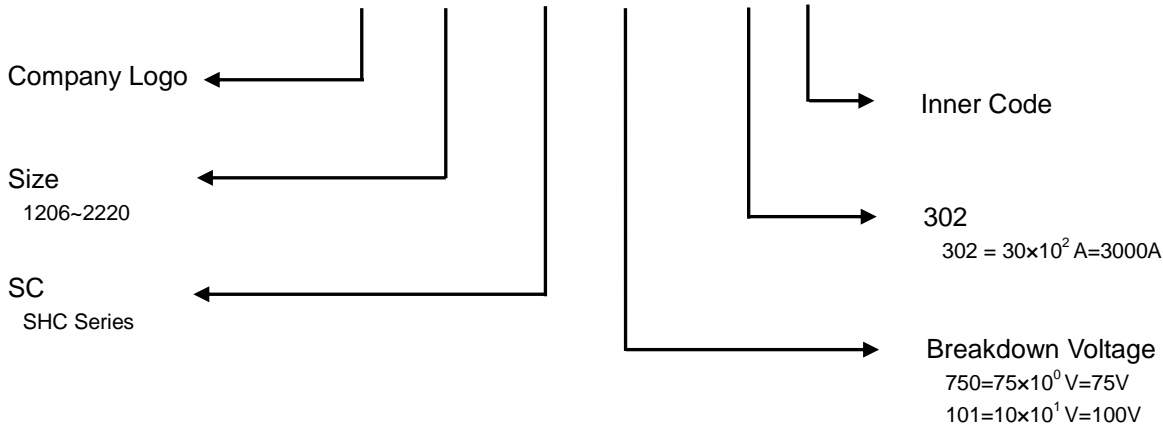

1.1 Features of SHC Series

1. RoHS compliant
2. SMD type body size 1206~2220
3. Meet IEC61000-4-5 / K21 standards
4. Bidirectional and symmetrical V/I characteristics
5. Large withstanding surge current capability : 400A~8000A (@8/20μs)
6. Excellent low leakage current
7. Operating temperature range : -55~+125°C
8. Multi-Layers construction provides higher power dissipation

Equivalent Circuit

- ☆L Body Inductance
- ☆C Device Capacitance
- ☆VR Voltage Variable Resistor
- ☆R Insulation Resistor
- ☆Diode Voltage Clamped
- ☆PTC for Low Leakage Current

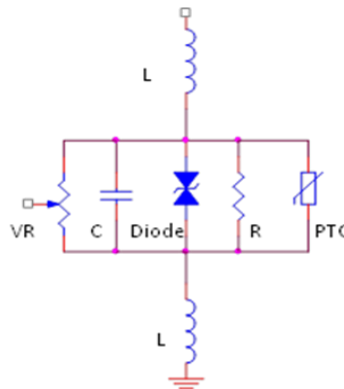

Part No.	SHC Series	Document No.	AS-RDSHC-S01	REV.	G
http://www.sfi.com.tw E-mail : sfi@sfi.com.tw TEL : 886-3-3506998 FAX : 886-3-3507689 - 2 -					



1.2 Performance Characteristics

Part Number	Working Voltage (Max.)		Breakdown Voltage	Clamping Voltage (Max.)	Peak Current (8/20 μ s) (Max.)
	V _{AC}	V _{DC}			
Symbol	V _{AC}	V _{DC}	V _B	V _C	I _{Peak}
Unit	V	V	V	V	A
SFI1206SC120-501A	6	9	12(12~20)	30	500
SFI1206SC240-501A	14	18	24(\pm 10%)	45	500
SFI1206SC470-501A	30	38	47(\pm 10%)	85	500
SFI1206SC560-102A	35	45	56(\pm 10%)	90	1000
SFI1206SC750-501A	48	60	75(\pm 10%)	100	500
SFI1210SC240-102A	14	18	24(\pm 10%)	45	1000
SFI1210SC470-102A	30	38	47(\pm 10%)	85	1000
SFI1210SC750-102A	48	60	75(\pm 10%)	100	1000
SFI1210SC101-401A	60	85	100(\pm 10%)	165	400
SFI1812SC470-202A	30	38	47(\pm 10%)	85	2000
SFI1812SC750-202A	48	60	75(\pm 10%)	100	2000
SFI2220SC470-502A	30	38	47(\pm 10%)	85	5000
SFI2220SC470-802A	30	38	47(\pm 10%)	85	8000
SFI2220SC750-302A	48	60	75(\pm 10%)	100	3000

Part No.	SHC Series	Document No.	AS-RDSHC-S01	REV.	G
http://www.sfi.com.tw E-mail : sfi@sfi.com.tw TEL : 886-3-3506998 FAX : 886-3-3507689 - 3 -					



1.3 Reference Data

Part No.	Non-linear Coefficient	Leakage Current at $V_B \times 80\%$		Capacitance (1KHz)	Response Time	Operation Ambient Temperature	Storage Temperature Range
		at initial state	after surge test				
Symbol	α	I_{VB}	I_{VBA}	C	T_{rise}	T_{OPT}	T_{STG}
Unit		μA	μA	pF	ns	$^{\circ}C$	$^{\circ}C$
SFI1206SC120-501A	20	<10	<80	3500	<1ns	-55~+125	-55~+150
SFI1206SC240-501A	20	<10	<80	2300			
SFI1206SC470-501A	30	<10	<80	690			
SFI1206SC560-102A	30	<10	<80	800			
SFI1206SC750-501A	30	<10	<80	300			
SFI1210SC240-102A	20	<15	<80	2300			
SFI1210SC470-102A	30	<10	<80	1550			
SFI1210SC750-102A	15	<50	<200	930			
SFI1210SC101-401A	30	<10	<80	250			
SFI1812SC470-202A	30	<15	<80	2100			
SFI1812SC750-202A	30	<15	<80	1650			
SFI2220SC470-502A	35	<15	<80	9900			
SFI2220SC470-802A	35	<15	<80	7500			
SFI2220SC750-302A	40	<15	<80	2000			

1.4 Other Data

Parameter	Value	Unit
Body	Nano special ceramic	
End termination	Ag/Ni/Sn(1206~2220)	
Packaging	Reel	
Marking	None	
Lead content	<1000	ppm

Notes :

- * 1 The breakdown voltage was measured at 1mA.
- * 2 The clamping voltage was measured at 8/20 μs standard current, 1206(1A), 1210(2.5A), 1812(5A) and 2220(10A).
- * 3 The capacitance value only for customer reference, it's not formal specification.
- * 4 The components shall be employed within 1 year, in the nitrogen condition.

Part No.	SHC Series	Document No.	AS-RDSHC-S01	REV.	G
http://www.sfi.com.tw E-mail : sfi@sfi.com.tw TEL : 886-3-3506998 FAX : 886-3-3507689 - 4 -					

2. Mechanical Characteristics

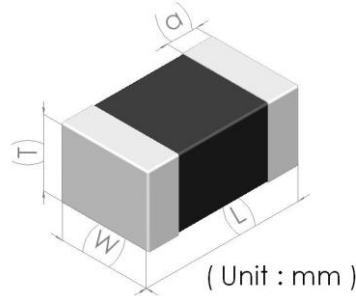

Model	1206 Series	1210 Series	1812 Series	2220 Series
Length(L)	3.20 +0.60/-0.20	3.20 +0.60/-0.20	4.50 +0.60/-0.20	6.00 +0.70/-0.30
Width(W)	1.60 +0.40/-0.20	2.50 +0.40/-0.20	3.20 +0.50/-0.20	5.30 +0.50/-0.30
Thickness(T)	1.90 max.	2.60 max.	3.50 max.	3.60 max.
Termination(a)	0.50±0.20	0.50±0.25	0.50 +0.35/-0.10	0.50 +0.35/-0.10

3. Surge Wave Form

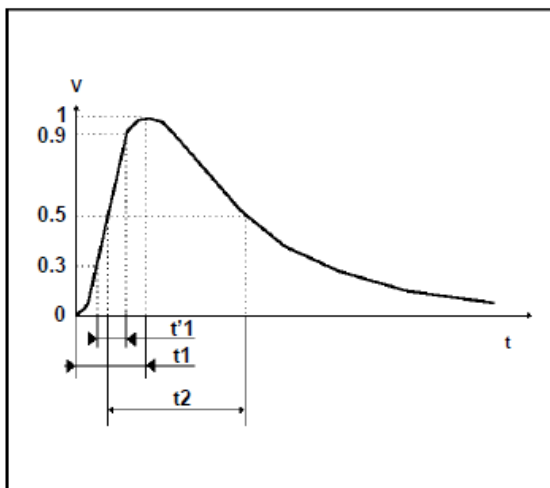

IEC61000-4-5 Standards

SEVERITY LEVEL	t1 (=1.67t ₁)	t2
1	8μs	20μs
2	10μs	1000μs

8/20μs and 10/1000μs waveform current

Part No.	SHC Series	Document No.	AS-RDSHC-S01	REV.	G
http://www.sfi.com.tw E-mail : sfi@sfi.com.tw TEL : 886-3-3506998 FAX : 886-3-3507689 - 5 -					



4. Environmental Reliability Test

Item	Requirement	Test condition
High Temperature Storage	1. Breakdown voltage change : within $\pm 10\%$ 2. No mechanical damage	1. Temperature : $150 \pm 2^\circ\text{C}$ 2. Time : 1000 ± 2 hours 3. Test after placing in ambient temperature for 24 hours.
Low Temperature Storage	1. Breakdown voltage change : within $\pm 10\%$ 2. No mechanical damage	1. Temperature : $-40 \pm 2^\circ\text{C}$ 2. Time : 1000 ± 2 hours 3. Test after placing in ambient temperature for 24 hours.
Temperature Cycle	1. Breakdown voltage change : within $\pm 10\%$ 2. No mechanical damage	1. Step 1 : $-40 \pm 3^\circ\text{C}$; time : 30 ± 3 min 2. Step 2 : 25°C ; time : 1 hour 3. Step 3 : $125 \pm 3^\circ\text{C}$; time : 30 ± 3 min 4. Step 4 : 25°C ; time : 1 hour 5. Number of cycle : 5 times 6. Test after placing in ambient temperature for 24 hours.
High Temperature Load	1. Breakdown voltage change : within $\pm 10\%$ 2. No mechanical damage	1. Temperature : $125 \pm 2^\circ\text{C}$ 2. Rated working voltage applied 3. Time : 1000 ± 2 hours 4. Test after placing in ambient temperature for 24 hours.
Damp Heat Load/ Humidity Load	1. Breakdown voltage change : within $\pm 10\%$ 2. No mechanical damage	1. Temperature : $40 \pm 2^\circ\text{C}$ 2. Humidity : 90~95% RH 3. Rated working voltage applied 4. Time : 500 ± 2 hours 5. Test after placing in ambient temperature for 24 hours.

Part No.	SHC Series	Document No.	AS-RDSHC-S01	REV.	G
http://www.sfi.com.tw E-mail : sfi@sfi.com.tw TEL : 886-3-3506998 FAX : 886-3-3507689 - 6 -					

5. Soldering Recommendations

5.1 Recommended solder pad layout

(Unit : mm)

	A	B	C
1206	1.8~2.5	1.2~1.8	1.5~2.0
1210	1.8~2.5	1.3~2.0	2.5~3.3
1812	2.5~3.3	1.5~2.2	3.4~4.2
2220	4.1~4.9	1.4~2.2	5.6~6.4

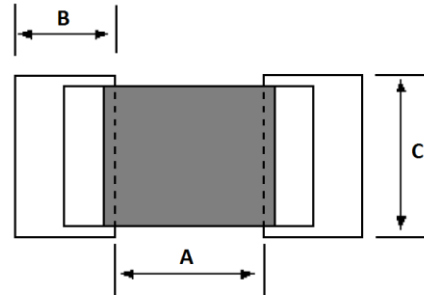

5.2 The SIR test of the solder paste shall be done (Based on JIS-Z-3284)

5.3 Steel plate and foot distance printing

Foot distance printing (mm)	Steel plate thickness (mm)
$\geq 0.65\text{mm}$	0.18mm
0.50~0.65mm	0.15mm
0.40~0.50mm	0.12mm
$\leq 0.40\text{mm}$	0.10mm

5.4 The IR reflow and temperature of soldering for Pb free process

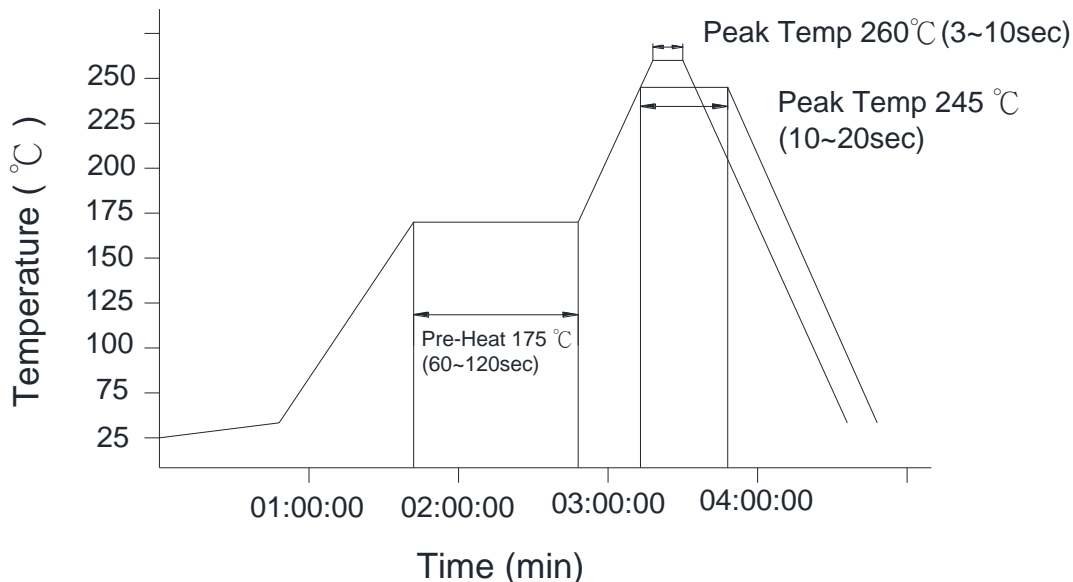

☆ IR reflow Pb free process suggestion profile

- (1) The solder recommend is Sn96.5/Ag3.5, and thickness recommend as shown in table 5.3
- (2) Ramp-up rate (217°C to peak) +3°C/second max.
- (3) Temp. maintain at 175±25°C 180 seconds max.

Part No.	SHC Series	Document No.	AS-RDSHC-S01	REV.	G
http://www.sfi.com.tw E-mail : sfi@sfi.com.tw TEL : 886-3-3506998 FAX : 886-3-3507689 -7-					



- (4) Temp. maintain above 217°C 60~150 seconds
 - (5) Peak temperature range 245 +20°C/-10°C within 5°C of actually peak temperature (t_p) 10~20 seconds
 - (6) Ramp down rate -6°C/second max.
- ※ Perform adequate test in advance as the reflow temperature profile will vary according to the conditions of the manufacturing process and the specification of the reflow furnace.

5.5 Resistance to soldering heat and high temperature resistance : 260°C, 10sec 3 times

5.6 Hand soldering

In hand soldering of the SHC devices, large temperature gradient between preheated the SHC devices and the tip of soldering iron may cause electrical failures and mechanical damages such as cracking or breaking of the devices. The soldering shall be carefully controlled and carried out, so that the temperature gradient is kept minimum with following recommended conditions for hand soldering.

5.6.1 Recommended soldering condition 1 (with preheating)

- (1) Solder
0.12~0.18mm thread solder (Sn96.5:Ag3.5) with soldering flux in the core, and rosin-based non-activated flux is recommended.
- (2) Preheating
 The SHC devices shall be preheated so that temperature gradient between the devices and the tip of soldering iron is 150°C or below.
- (3) Soldering iron
 Rated power of 20W max. with 3mm soldering tip in diameter.
 Temperature of soldering iron tip 380°C max., 3~5sec (The required amount of solder shall be melted in advance on the soldering tip.)
- (4) Cooling
 After soldering, the SHC devices shall be cooled gradually at room ambient temperature.

5.6.2 Recommended soldering condition 2 (without preheating)

- (1) Solder iron tip shall not directly touch to ceramic dielectrics.
- (2) Solder iron tip shall be fully preheated before soldering while soldering iron tip to the external electrode of SHC devices.

5.7 Post soldering cleaning

5.7.1 Residues of corrosive soldering fluxes on the PC board after cleaning may greatly have influences on the electrical characteristic and the reliability (such as humidity resistance) of the SHC devices which have been mounted on the board. It shall be confirmed that the characteristic and the reliability of the devices are not affected by the applied cleaning conditions.

5.7.2 When an ultrasonic cleaning is applied to the mounted SHC devices on PC boards. Following conditions are recommended for preventing failures or damages of the devices due to the large vibration energy and the resonance conditions caused by the ultrasonic waves.

- (1) Frequency 29MHz max.
- (2) Radiated power 20W/liter max.
- (3) Period 5minuets max.

Part No.	SHC Series	Document No.	AS-RDSHC-S01	REV.	G
http://www.sfi.com.tw E-mail : sfi@sfi.com.tw TEL : 886-3-3506998 FAX : 886-3-3507689 - 8 -					



6. Standard Packaging

Size	1206	1210	1812	2220
Pcs	2000 (7 inch reel)	1500 (7 inch reel)	500 (7 inch reel)	500 (7 inch reel)

Part No.	SHC Series	Document No.	AS-RDSHC-S01	REV.	G
http://www.sfi.com.tw E-mail : sfi@sfi.com.tw TEL : 886-3-3506998 FAX : 886-3-3507689 - 9 -					

单击下面可查看定价，库存，交付和生命周期等信息

[>>SFI\(台湾立昌\)](#)