



Approval Sheet

Customer Information

Customer			
Part Name			
Part No.			
Model No.			
COMPANY	PURCHASE	R&D	

Vendor Information

Name	SFI Electronics Technology Inc.
Part Name	Semiconductor TVS Device
Part No.	SFI0603TS3R3-100K-11
Lot No.	

SFI Electronics Technology Inc.

ADDRESS : No.6, Lane 340, Shan-Ying Road, Guishan, Tao Yuan, Taiwan

TEL : 886-3-3506998 FAX : 886-3-3507689 E-mail : sfi@sfi.com.tw

Quality Control	Document Control	Business Issue	
 <p>ISO 9001:2008 ISO 14001:2004 ISO/TS 16949:2009 Management System www.tuv.com ID 1100008833</p>	REV : A	Prepared	Check
			

Part No.	SFI0603TS3R3-100K-11	Document No.	AS-ST0603ME41-LF	REV.	A
http://www.sfi.com.tw E-mail : sfi@sfi.com.tw TEL : 886-3-3506998 FAX : 886-3-3507689 - 1 -					



1. Part Number Identification

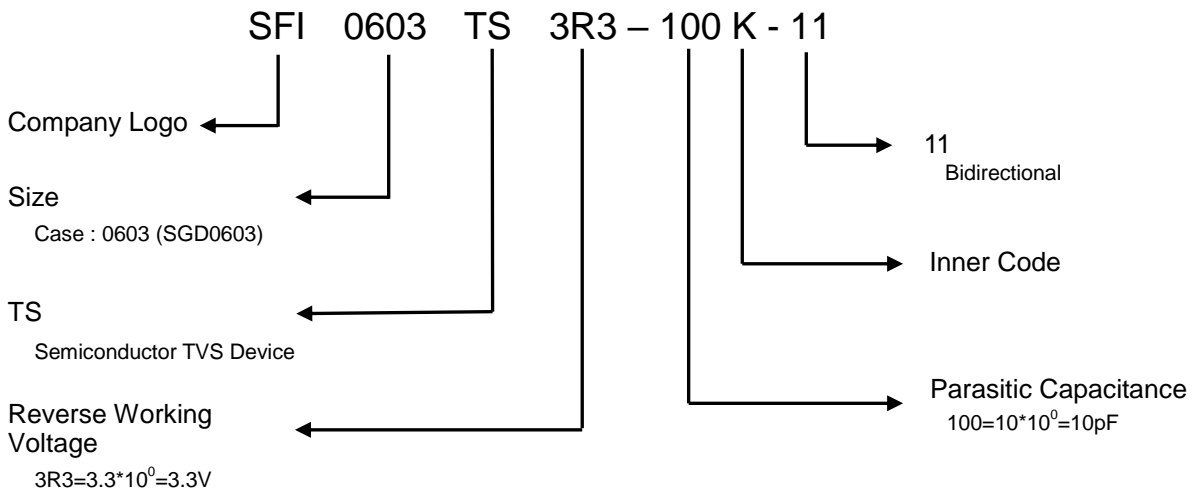

1.1 Features

- (1) Transient protection for high-speed data lines
IEC61000-4-2 (ESD) $\pm 30KV$ (air)
 $\pm 30KV$ (contact)
IEC61000-4-4 (EFT) 40A (5/50ns)
Cable discharge event (CDE)
- (2) Package optimized for high-speed lines
- (3) Ultra-small package (1.6mm×0.8mm×0.6mm)
- (4) Protects one data, controller or power line
- (5) Capacitance : 10pF (typical)
- (6) Low leakage current : 1nA @ V_{RWM} (typical)
- (7) Low clamping voltage
- (8) Each I/O pin can withstand over 1000 ESD strikes for $\pm 8KV$ contact discharge

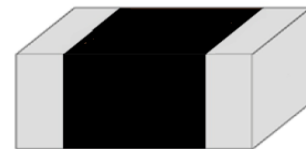

1.2 Description

SFI0603TS3R3-100K-11 is a Transient Voltage Suppressor (TVS) designed to provide electrostatic discharge (ESD) protection for data, control or power lines. With typical capacitance of 10pF only, SFI0603TS3R3-100K-11 is designed to protect parasitic-sensitive systems against over-voltage and over-current transient events. It complies with IEC61000-4-2(ESD), Level 4 ($\pm 30KV$ air, $\pm 30KV$ contact discharge), IEC61000-4-4 (electrical fast transient -EFT) (40A, 5/50ns), very fast charged device model (CDM) ESD and cable discharge event (CDE), etc.

SFI0603TS3R3-100K-11 uses small 0603 (SGD0603) package. Each SFI0603TS3R3-100K-11 device can protect one data line. It offers system designers flexibility to protect single data line where space is a premium concern.

Part No.	SFI0603TS3R3-100K-11	Document No.	AS-ST0603ME41-LF	REV.	A
http://www.sfi.com.tw E-mail : sfi@sfi.com.tw TEL : 886-3-3506998 FAX : 886-3-3507689 - 2 -					



1.3 Applications

- (1) Portable electronics
- (2) Desktops, servers and notebooks
- (3) Cellular phones
- (4) MP3 ports
- (5) Digital camera ports
- (6) Subscriber identity module (SIM) card

1.4 Absolute Maximum Ratings (Ta=25°C)

ITEM	Symbol	Rating	Unit
Peak pulse power ($t_p=8/20\mu s$)	P_{PK}	80	W
Peak pulse current ($t_p=8/20\mu s$)	I_{PP}	8	A
ESD per IEC61000-4-2 (air)	V_{ESD}	± 30	KV
ESD per IEC61000-4-2 (contact)	V_{ESD}	± 30	KV
Operating temperature range	T_{OPT}	-55~125	°C
Storage temperature range	T_{STG}	-55~150	°C

1.5 Electrical Characteristics (Ta=25°C)

Symbol	Parameter
V_{RWM}	Nominal Reverse Working Voltage
I_R	Reverse Leakage Current @ V_{RWM}
V_{BR}	Reverse Breakdown Voltage @ I_T
I_T	Test Current for Reverse Breakdown
V_C	Clamping Voltage @ I_{PP}
I_{PP}	Maximum Peak Pulse Current
C_{ESD}	Parasitic Capacitance
V_R	Reverse Voltage
f	Small Signal Frequency

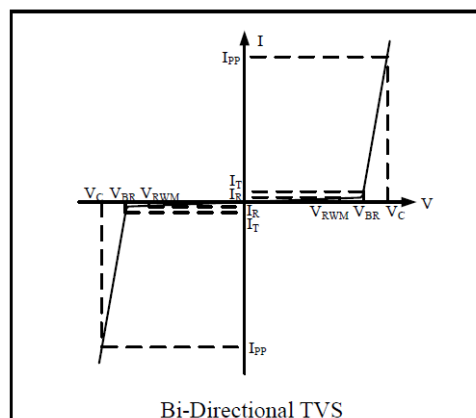

Part No.	SFI0603TS3R3-100K-11	Document No.	AS-ST0603ME41-LF	REV.	A
http://www.sfi.com.tw E-mail : sfi@sfi.com.tw TEL : 886-3-3506998 FAX : 886-3-3507689 - 3 -					



ITEM	Symbol	SFI0603TS3R3-100K-11	Unit
Working peak reverse voltage	V_{RWM}	3.3	V
Maximum reverse leakage (@ V_{RWM} , 25°C) (between I/O_1 and I/O_2)	I_R	Typ. 0.001 (Max. 0.1)	μA
Breakdown voltage (@ $I_T=1mA$) (between I/O_1 and I/O_2)	V_{BR}	Typ. 4.7 (Min. 3.4)	V
Clamping voltage (@ $I_{PP}=16A$, $t_p=100ns$, TLP)	V_{CL}	10	V
Clamping voltage (@ $V_{ESD}=8KV$)	V_{CL}	10	V
Maximum clamping voltage (@ $I_{PP}=1A$, $t_p=8/20\mu s$) (between I/O_1 and I/O_2)	V_C	Max. 6	V
Maximum clamping voltage (@ $I_{PP}=8A$, $t_p=8/20\mu s$) (between I/O_1 and I/O_2)	V_C	Max. 10	V
Parasitic capacitance (@ $V_R=0V$, $f=1MHz$) (between I/O_1 and I/O_2)	C_{ESD}	Typ. 10	pF

2. Mechanical Characteristics

- (1) Case : 0603 (SGD0603 package)
- (2) Flammability rating : UL 94V-0
- (3) Packaging : tape and reel
- (4) Polarity : bidirectional

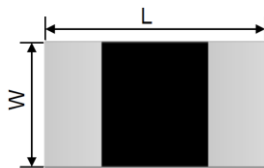

Top View (Bottom View)

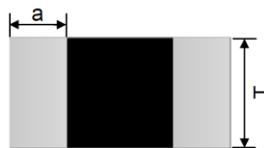

Side View

(unit : mm)

Model	0603 (SGD0603)
Length(L)	1.60 ± 0.10
Width(W)	0.80 ± 0.10
Thickness(T)	0.60 ± 0.10
Termination(a)	0.30 ± 0.05

2.1 Circuit Diagram



2.2 Pin Configuration

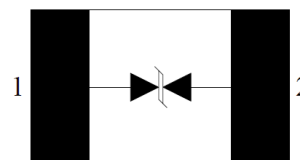

0603 (SGD0603)
(TOP View)

Part No.	SFI0603TS3R3-100K-11	Document No.	AS-ST0603ME41-LF	REV.	A
http://www.sfi.com.tw E-mail : sfi@sfi.com.tw TEL : 886-3-3506998 FAX : 886-3-3507689 - 4 -					



3. Rating and Characteristic Curves

TLP Measurement

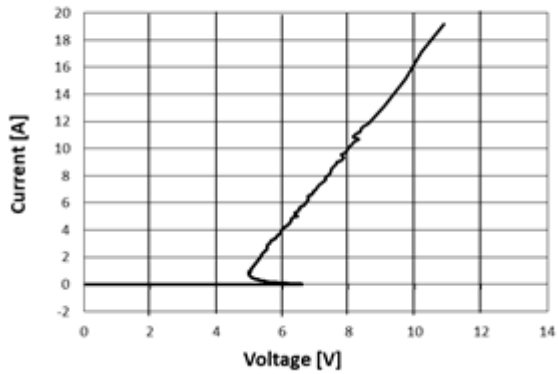

Voltage Sweeping of I/O_1 to I/O_2

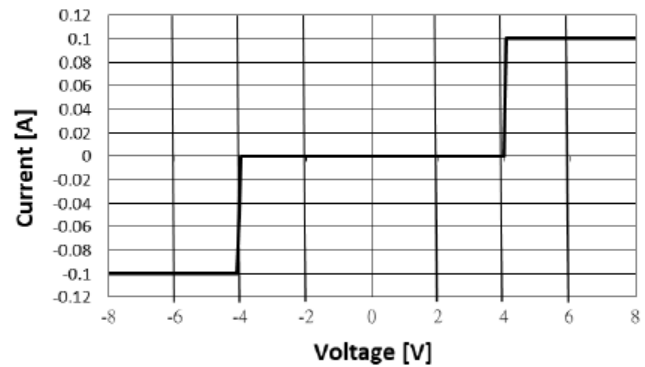

ESD Clamping of I/O_1 to I/O_2
(+8kV Contact per IEC 61000-4-2)

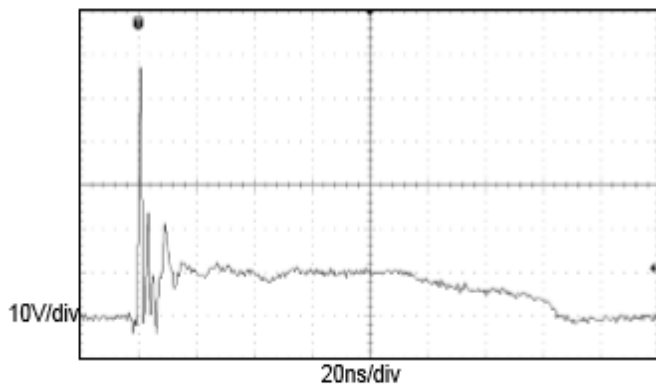

ESD Clamping of I/O_1 to I/O_2
(-8kV Contact per IEC 61000-4-2)

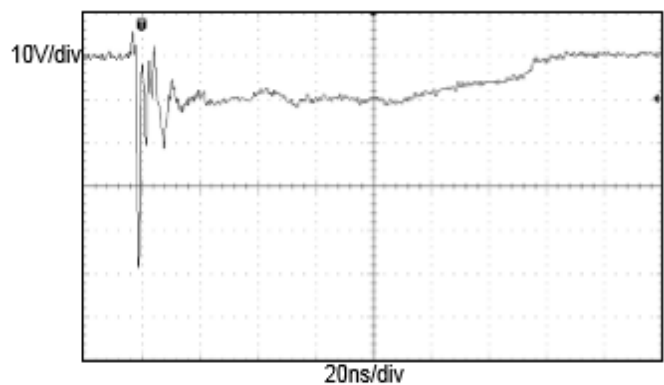

Part No.	SFI0603TS3R3-100K-11	Document No.	AS-ST0603ME41-LF	REV.	A
----------	-----------------------------	--------------	-------------------------	------	----------

<http://www.sfi.com.tw> E-mail : sfi@sfi.com.tw TEL : 886-3-3506998 FAX : 886-3-3507689 - 5 -

4. Soldering Recommendations

4.1 Recommended solder pad layout

(Unit : mm)

	A	B	C
0603	0.9~1.2	0.9~1.2	0.8~1.0

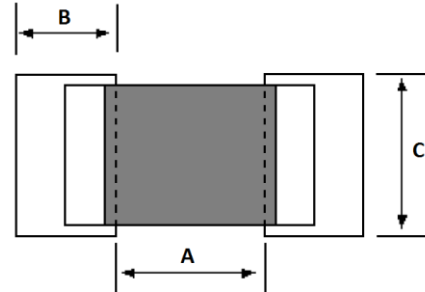

4.2 The IR reflow and temperature of soldering for Pb free process

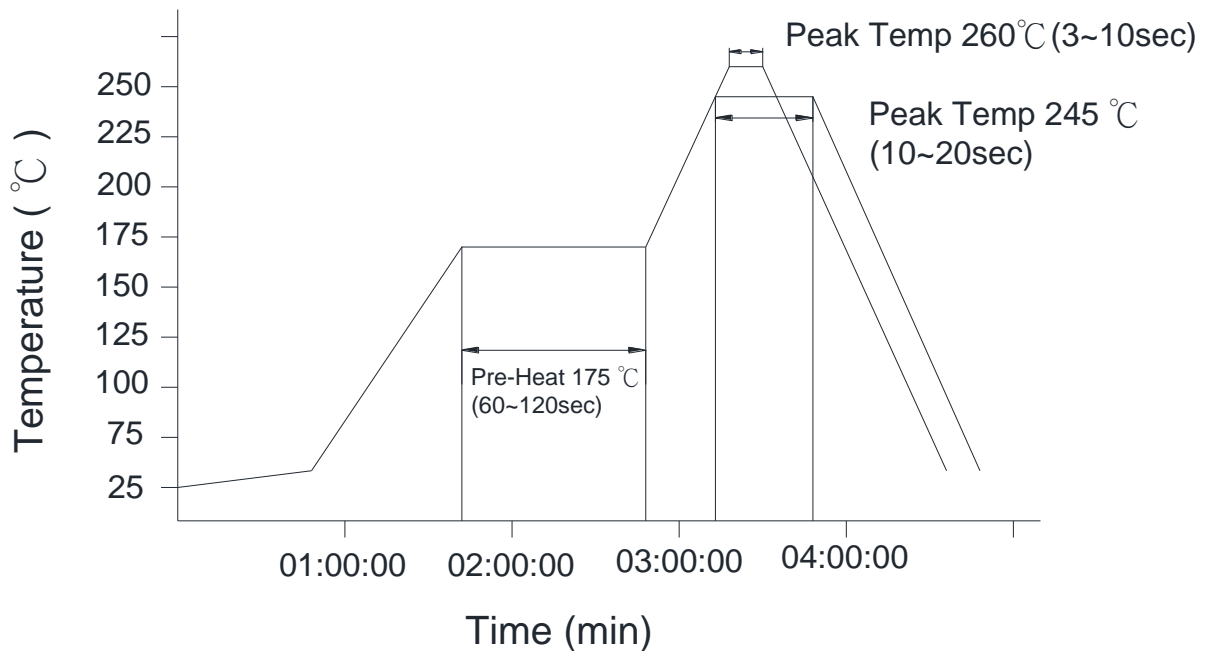

☆ IR reflow Pb free process suggestion profile

- (1) The solder recommend is Sn96.5/Ag3.5 of 80 to 130 μ m
- (2) Ramp-up rate (217 $^{\circ}$ C to peak) +3 $^{\circ}$ C/second max.
- (3) Temp. maintain at 175 \pm 30 $^{\circ}$ C 180 seconds max.
- (4) Temp. maintain above 217 $^{\circ}$ C 60~150 seconds
- (5) Peak temperature range 245 +20/-10 $^{\circ}$ C within 5 $^{\circ}$ C of actually peak temperature (t_p) 10~20 seconds
- (6) Ramp down rate -6 $^{\circ}$ C/second max.
- (7) Steel plate thickness 0.08~0.12mm

Part No.	SFI0603TS3R3-100K-11	Document No.	AS-ST0603ME41-LF	REV.	A
http://www.sfi.com.tw E-mail : sfi@sfi.com.tw TEL : 886-3-3506998 FAX : 886-3-3507689 - 6 -					



4.3 Hand soldering

In hand soldering of the STS devices, large temperature gradient between preheated the STS devices and the tip of soldering iron may cause electrical failures and mechanical damages such as cracking or breakings of the devices. The soldering shall be carefully controlled and carried out, so that the temperature gradient is kept minimum with following recommended conditions for hand soldering.

4.3.1 Recommended soldering condition 1 (with preheating)

(1) Solder

0.12~0.18mm thread solder (Sn96.5:Ag3.5) with soldering flux in the core
rosin-based and non-activated flux is recommended.

(2) Preheating

The STS devices shall be preheated so that temperature gradient between the devices and the tip of soldering iron is **150°C** or below.

(3) Soldering iron

Rated power of 20W max. with 3mm soldering tip in diameter

Temperature of soldering iron tip **300°C max. 3-5sec** (The required amount of solder shall be melted in advance on the soldering tip.)

(4) Cooling

After soldering, the STS devices shall be cooled gradually at room ambient temperature.

4.3.2 Recommended soldering condition 2 (without preheating)

(1) Temperature of soldering iron tip **300°C max. 3-5sec**

(2) Solder iron tip shall not directly touch to STS devices.

(3) Solder iron tip shall be fully preheated before soldering while soldering iron tip to the external electrode of STS devices.

Part No.	SFI0603TS3R3-100K-11	Document No.	AS-STSO603ME41-LF	REV.	A
http://www.sfi.com.tw E-mail : sfi@sfi.com.tw TEL : 886-3-3506998 FAX : 886-3-3507689 - 7 -					

5. Packaging Specification

- 5.1 Carrier tape and transparent cover tape should be heat-sealed to carry the products, and the reel should be used to reel the carrier tape.
- 5.2 The adhesion of the heat-sealed cover tape shall be 40 +20/-15 grams.
- 5.3 Both the head and the end portion of the taping shall be empty for reel package and SMT auto-pickup machine. And a normal paper tape shall be connected in the head of taping for the operator to handle.

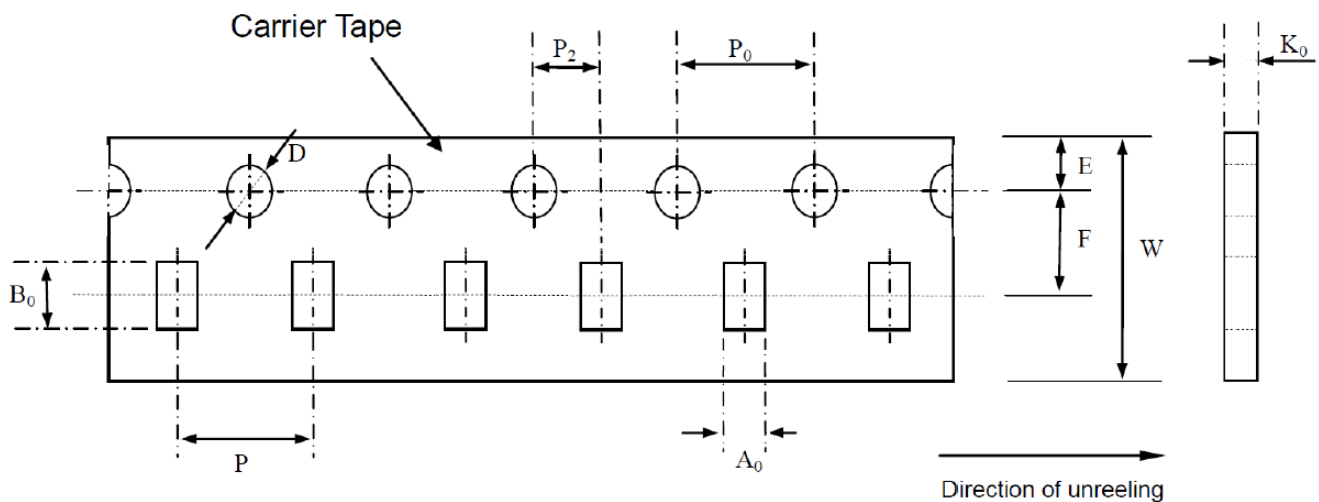

(Unit : mm)

Symbol	A_0 ± 0.05	B_0 ± 0.05	K_0 ± 0.05	D $+0.10$ -0.05	P ± 0.10	P_2 ± 0.10	P_0 ± 0.10	W ± 0.10	E ± 0.10	F ± 0.05
0603	1.00	1.80	0.70	1.50	4.00	2.00	4.00	8.00	1.75	3.50

Part No.	SFI0603TS3R3-100K-11	Document No.	AS-ST0603ME41-LF	REV.	A
http://www.sfi.com.tw E-mail : sfi@sfi.com.tw TEL : 886-3-3506998 FAX : 886-3-3507689 - 8 -					

6. Reel Dimension

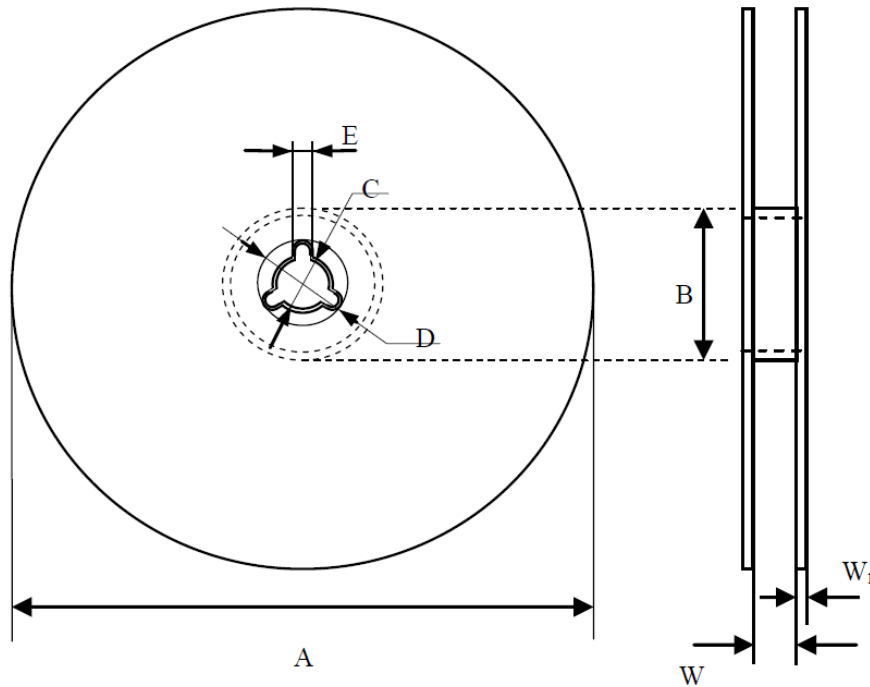

(Unit : mm)

Symbol	A	B	C	D	E	W	W ₁
0603	178.0±1.0	60.0±0.5	13.0±0.2	21.0±0.2	2.0±0.5	9.0±0.5	1.5±0.1

7. Ordering Information

Part Number	Working Voltage	Quantity	Reel Size
SFI0603TS3R3-100K-11	3.3V	5000	7 inch

Part No.	SFI0603TS3R3-100K-11	Document No.	AS-ST0603ME41-LF	REV.	A
http://www.sfi.com.tw E-mail : sfi@sfi.com.tw TEL : 886-3-3506998 FAX : 886-3-3507689 - 9 -					

单击下面可查看定价，库存，交付和生命周期等信息

[>>SFI\(台湾立昌\)](#)