

GENERAL DESCRIPTION

The SGM706B is an integrated microprocessor supervisory device. Compared with the design using a single IC or discrete components, this integration design has the advantage of improving system stability and accuracy. The SGM706B can be reset under power-up, power-down or even voltage reduction brownout conditions. When V_{CC} is as low as 1V, the reset output can still operate. And it also has a low-level active manual reset nMR function.

The SGM706B provides an independent watchdog monitoring circuit, which can activate this function when its power input has not toggled for more than 1.6s.

When the power supply fails, the battery power is low, or the additional power supply needs to be monitored, it can be realized by the 1.25V threshold detector of the SGM706B.

The SGM706B is available in Green UTDFN-1.5×1.5-8L, SOIC-8 and MSOP-8 packages. It operates over an ambient temperature range of -40°C to +125°C.

TYPICAL APPLICATION

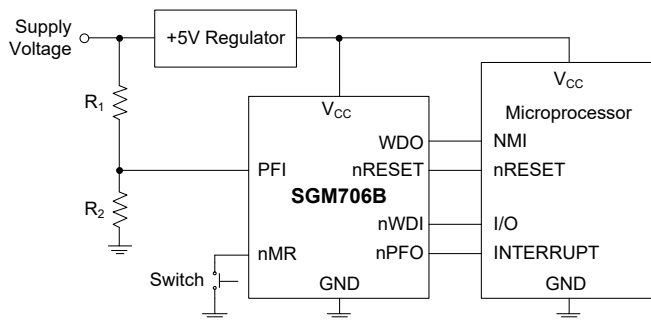

FEATURES

- **Ultra-Low Supply Current:** < 1μA (TYP)
- **Precision Supply-Voltage Monitor**
 - 4.63V for SGM706B-L
 - 4.38V for SGM706B-M
 - 4.0V for SGM706B-J
 - 3.08V for SGM706B-T
 - 2.93V for SGM706B-S
 - 2.63V for SGM706B-R
- **Guaranteed nRESET Valid at $V_{CC} = 1V$**
- **Reset Pulse Width:** 200ms (TYP)
- **Debounced TTL/CMOS-Compatible**
- **Manual Reset Input**
- **Watchdog Timer with 1.6s (TYP) Timeout**
- **1.25V Threshold Detector for Power-Fail or Low-Battery Warning**
- **-40°C to +125°C Operating Temperature Range**
- **Available in Green UTDFN-1.5×1.5-8L, SOIC-8 and MSOP-8 Packages**

APPLICATIONS

- Computers
- Battery-Powered Applications
- Portable Equipment
- Automotive Equipment
- Safety Systems
- Intelligent Instruments
- Critical μP Power Monitoring
- Microprocessor Systems

PACKAGE/ORDERING INFORMATION

MODEL	RESET THRESHOLD (V)	PACKAGE DESCRIPTION	ORDERING NUMBER	PACKAGE MARKING	PACKING OPTION
SGM706B	4.63	UTDFN-1.5×1.5-8L	SGM706B-LXUDW8G/TR	CK0 XXX	Tape and Reel, 4000
	4.63	SOIC-8	SGM706B-LXS8G/TR	SGM 706BLXS8 XXXXX	Tape and Reel, 4000
	4.63	MSOP-8	SGM706B-LXMS8G/TR	SGM706BL XMS8 XXXXX	Tape and Reel, 4000
	4.38	UTDFN-1.5×1.5-8L	SGM706B-MXUDW8G/TR	CK1 XXX	Tape and Reel, 4000
	4.38	SOIC-8	SGM706B-MXS8G/TR	SGM 706BMXS8 XXXXX	Tape and Reel, 4000
	4.38	MSOP-8	SGM706B-MXMS8G/TR	SGM706BM XMS8 XXXXX	Tape and Reel, 4000
	4.0	UTDFN-1.5×1.5-8L	SGM706B-JXUDW8G/TR	CK2 XXX	Tape and Reel, 4000
	4.0	SOIC-8	SGM706B-JXS8G/TR	SGM 706BJXS8 XXXXX	Tape and Reel, 4000
	4.0	MSOP-8	SGM706B-JXMS8G/TR	SGM706BJ XMS8 XXXXX	Tape and Reel, 4000
	3.08	UTDFN-1.5×1.5-8L	SGM706B-TXUDW8G/TR	CG5 XXX	Tape and Reel, 4000
	3.08	SOIC-8	SGM706B-TXS8G/TR	SGM 706BTXS8 XXXXX	Tape and Reel, 4000
	3.08	MSOP-8	SGM706B-TXMS8G/TR	SGM706BT XMS8 XXXXX	Tape and Reel, 4000
	2.93	UTDFN-1.5×1.5-8L	SGM706B-SXUDW8G/TR	CBE XXX	Tape and Reel, 4000
	2.93	SOIC-8	SGM706B-SXS8G/TR	SGM 706BSXS8 XXXXX	Tape and Reel, 4000
	2.93	MSOP-8	SGM706B-SXMS8G/TR	SGM706BS XMS8 XXXXX	Tape and Reel, 4000
	2.63	UTDFN-1.5×1.5-8L	SGM706B-RXUDW8G/TR	CG4 XXX	Tape and Reel, 4000
	2.63	SOIC-8	SGM706B-RXS8G/TR	SGM 706BRXS8 XXXXX	Tape and Reel, 4000
	2.63	MSOP-8	SGM706B-RXMS8G/TR	SGM706BR XMS8 XXXXX	Tape and Reel, 4000

PACKAGE/ORDERING INFORMATION (continued)

MARKING INFORMATION

NOTE: XXX = Date Code and Trace Code. XXXXX = Date Code, Trace Code and Vendor Code.

UTDFN-1.5x1.5-8L

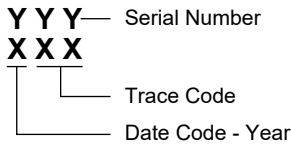

SOIC-8/MSOP-8

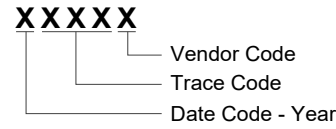

Green (RoHS & HSF): SG Micro Corp defines "Green" to mean Pb-Free (RoHS compatible) and free of halogen substances. If you have additional comments or questions, please contact your SGMICRO representative directly.

ABSOLUTE MAXIMUM RATINGS

Terminal Voltage (With Respect to GND)

V_{CC} -0.3V to 6.0V
 All Other Inputs -0.3V to (V_{CC} + 0.3V)

Input Current

V_{CC} 20mA
 GND 20mA

Output Current

All Outputs 20mA

Package Thermal Resistance

UTDFN-1.5x1.5-8L, θ_{JA} 131°C/W
 SOIC-8, θ_{JA} 145°C/W
 MSOP-8, θ_{JA} 190°C/W

Junction Temperature +150°C
 Storage Temperature Range -65°C to +150°C
 Lead Temperature (Soldering, 10s) +260°C

ESD Susceptibility

HBM 4000V
 MM 400V
 CDM 1000V

OVERSTRESS CAUTION

Stresses beyond those listed in Absolute Maximum Ratings may cause permanent damage to the device. Exposure to absolute maximum rating conditions for extended periods may affect reliability. Functional operation of the device at any conditions beyond those indicated in the Recommended Operating Conditions section is not implied.

ESD SENSITIVITY CAUTION

This integrated circuit can be damaged if ESD protections are not considered carefully. SGMICRO recommends that all integrated circuits be handled with appropriate precautions. Failure to observe proper handling and installation procedures can cause damage. ESD damage can range from subtle performance degradation to complete device failure. Precision integrated circuits may be more susceptible to damage because even small parametric changes could cause the device not to meet the published specifications.

DISCLAIMER

SG Micro Corp reserves the right to make any change in circuit design, or specifications without prior notice.

RECOMMENDED OPERATING CONDITIONS

Ambient Temperature Range -40°C to +125°C

PIN CONFIGURATIONS

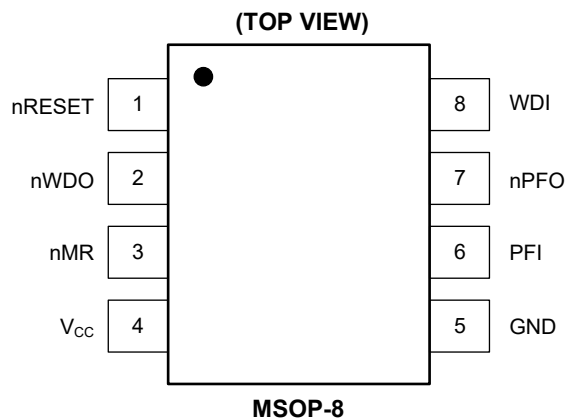
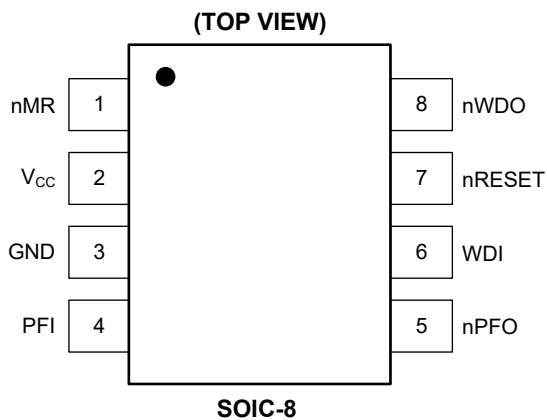
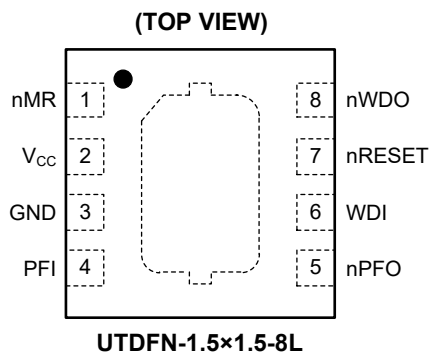

PIN DESCRIPTION

PIN			NAME	FUNCTION
UTDFN-1.5×1.5-8L	SOIC-8	MSOP-8		
1	1	3	nMR	Manual Reset Input Pin. It is an active-low reset input with an internal 234µA ($V_{CC} = +5V$) pull-up current. nMR can be driven by a CMOS/TTL logic or by a switch shorting to GND. If not used, leave it open or connect it to V_{CC} .
2	2	4	V_{CC}	Supply Voltage Pin.
3	3	5	GND	Ground.
4	4	6	PFI	Power-Fail Voltage Monitor Input Pin. nPFO will go low when PFI is lower than 1.25V. If not used, connect PFI to GND or V_{CC} .
5	5	7	nPFO	Power-Fail Voltage Monitor Output Pin. nPFO will go low when PFI is lower than 1.25V. nPFO will remain high when PFI is more than 1.25V.
6	6	8	WDI	Watchdog Input Pin. If the WDI remains high or low for longer than the watchdog timeout period (1.6s, TYP), the internal watchdog timer expires and WDO goes low. The internal watchdog timer is kept clear while a reset is asserted or WDI is three-stated. The timer is also cleared if the WDI input is changed (on rising or falling edges). The watchdog feature is disabled if the WDI is left open or if it is connected to a three-stated buffer output.
7	7	1	nRESET	Active-Low Reset Output Pin. It delivers a 200ms (TYP) low pulse when activated. nRESET remains low if V_{CC} is below the reset threshold or nMR is logic low. It goes (or remains) low for 200ms after any of the following events: V_{CC} rises above the reset threshold or the nMR input goes from low to high.
8	8	2	nWDO	Watchdog Output Pin. If the WDI finishes the watchdog timeout period (1.6s, TYP) and remains low before the timer is cleared, the \overline{WDO} goes low. WDO is different from RESET in that it does not have a minimum pulse width. Once V_{CC} is higher than the reset threshold, \overline{WDO} will immediately go high.
Exposed Pad	—	—	—	Exposed pad. It can be left floating.

ELECTRICAL CHARACTERISTICS

($T_A = +25^\circ\text{C}$, $V_{CC} = 4.72\text{V}$ to 5.5V for SGM706B-L; $V_{CC} = 4.47\text{V}$ to 5.5V for SGM706B-M; $V_{CC} = 4.08\text{V}$ to 5.5V for SGM706B-J; $V_{CC} = 3.15\text{V}$ to 5.5V for SGM706B-T; $V_{CC} = 2.99\text{V}$ to 5.5V for SGM706B-S; $V_{CC} = 2.69\text{V}$ to 5.5V for SGM706B-R, Full = -40°C to $+125^\circ\text{C}$, unless otherwise noted.)

PARAMETER	CONDITIONS	TEMP	MIN	TYP	MAX	UNITS	
Operating Voltage Range (V_{CC})		Full	1.0		5.5	V	
Supply Current (I_{SUPPLY})	$V_{CC} = 3.6\text{V}$	Full		0.6	1.2	μA	
	$V_{CC} = 5.5\text{V}$	Full		0.8	1.5	μA	
nRESET Threshold (V_{nRST})	SGM706B-L	$+25^\circ\text{C}$	4.55	4.63	4.70	V	
		Full	4.52	4.63	4.72		
	SGM706B-M	$+25^\circ\text{C}$	4.30	4.38	4.45		
		Full	4.28	4.38	4.47		
	SGM706B-J	$+25^\circ\text{C}$	3.93	4.0	4.07		
		Full	3.92	4.0	4.08		
	SGM706B-T	$+25^\circ\text{C}$	3.03	3.08	3.14		
		Full	3.02	3.08	3.15		
	SGM706B-S	$+25^\circ\text{C}$	2.88	2.93	2.98		
		Full	2.87	2.93	2.99		
	SGM706B-R	$+25^\circ\text{C}$	2.58	2.63	2.68		
		Full	2.57	2.63	2.69		
nRESET Threshold Hysteresis	SGM706B-L	$+25^\circ\text{C}$		20		mV	
	SGM706B-M	$+25^\circ\text{C}$		19			
	SGM706B-J	$+25^\circ\text{C}$		17			
	SGM706B-T	$+25^\circ\text{C}$		13			
	SGM706B-S	$+25^\circ\text{C}$		13			
	SGM706B-R	$+25^\circ\text{C}$		11			
nRESET Threshold Temperature Coefficient		Full		20		ppm/ $^\circ\text{C}$	
nRESET Pulse Width (t_{RS})		Full	140	200	290	ms	
nRESET Output Voltage	$I_{SOURCE} = 800\mu\text{A}$	Full	$0.7 \times V_{CC}$			V	
	$I_{SINK} = 3.2\text{mA}$	Full			0.4		
	$V_{CC} = 1\text{V}$, $I_{SINK} = 50\mu\text{A}$	Full			0.3		
Watchdog Timeout Period (t_{WD})		Full	1.1	1.6	2.4	s	
WDI Pulse Width (t_{WP})	$V_{IL} = 0\text{V}$, $V_{IH} = V_{CC}$	Full	90			ns	
WDI Input Threshold	Low	$V_{CC} = 5\text{V}$	Full		0.8	V	
	High	$V_{CC} = 5\text{V}$	Full	3.5			
	Low	$V_{nRST(MAX)} < V_{CC} < 3.6\text{V}$	Full		0.8		
	High	$V_{nRST(MAX)} < V_{CC} < 3.6\text{V}$	Full	$0.7 \times V_{CC}$			
WDI Input Current	WDI = V_{CC}	UTDFN-1.5 \times 1.5-8L only	Full		0.01	1.2	μA
		Other packages	Full		0.01	1.0	
	WDI = 0V	Full	-1.0	-0.01			
nWDO Output Voltage	$I_{SOURCE} = 800\mu\text{A}$	Full	$0.7 \times V_{CC}$			V	
	$I_{SINK} = 1.2\text{mA}$	Full			0.2		

ELECTRICAL CHARACTERISTICS (continued)

($T_A = +25^\circ\text{C}$, $V_{CC} = 4.72\text{V}$ to 5.5V for SGM706B-L; $V_{CC} = 4.47\text{V}$ to 5.5V for SGM706B-M; $V_{CC} = 4.08\text{V}$ to 5.5V for SGM706B-J; $V_{CC} = 3.15\text{V}$ to 5.5V for SGM706B-T; $V_{CC} = 2.99\text{V}$ to 5.5V for SGM706B-S; $V_{CC} = 2.69\text{V}$ to 5.5V for SGM706B-R, Full = -40°C to $+125^\circ\text{C}$, unless otherwise noted.)

PARAMETER	CONDITIONS		TEMP	MIN	TYP	MAX	UNITS
nMR Pull-Up Current	nMR = 0V, $V_{CC} = 5\text{V}$		Full	100		300	μA
nMR Pulse Width (t_{MR})			Full	300			ns
nMR Input Threshold	Low		Full			0.8	V
	High		Full	2			
nMR to nRESET Out Delay (t_{MD})			Full			420	ns
PFI Input Threshold	$V_{CC} = 5\text{V}$	UTDFN-1.5×1.5-8L only	Full	1.20	1.25	1.30	V
		Other packages	Full	1.21	1.25	1.29	V
PFI Input Current			Full		0.2	50	nA
nPFO Output Voltage	$I_{SOURCE} = 800\mu\text{A}$		Full	$0.7 \times V_{CC}$			V
	$I_{SINK} = 3.2\text{mA}$		Full			0.3	

TYPICAL PERFORMANCE CHARACTERISTICS

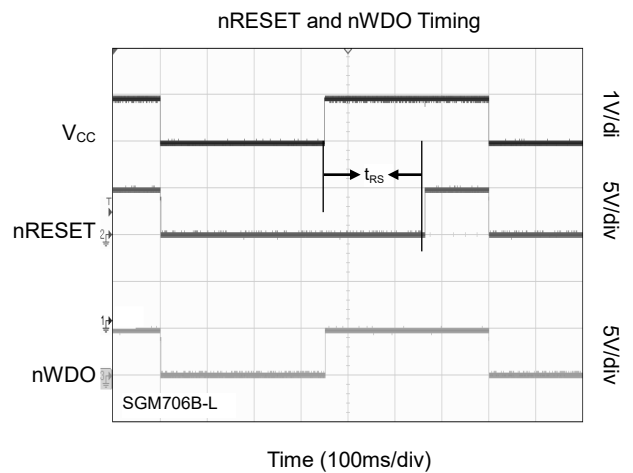
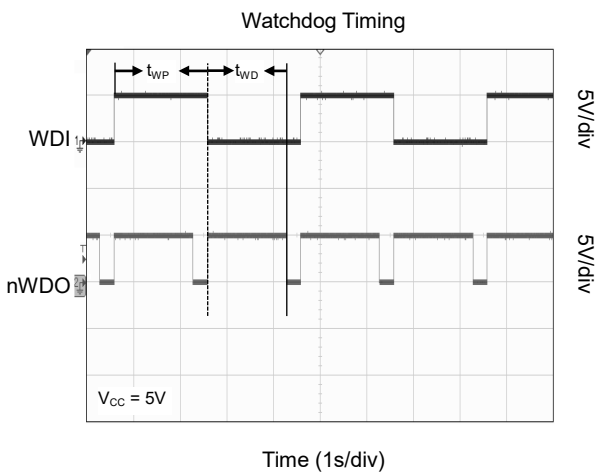
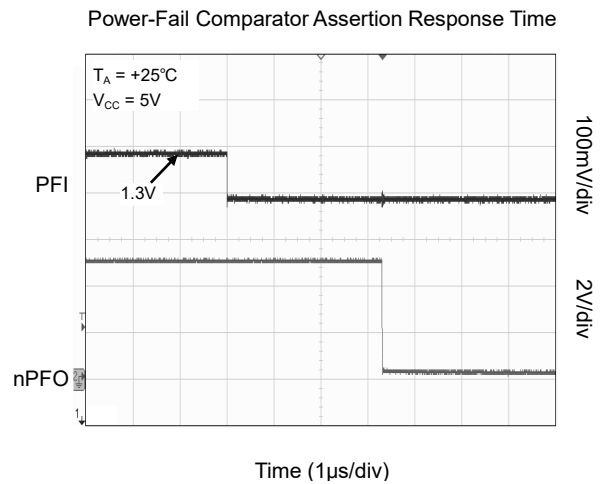
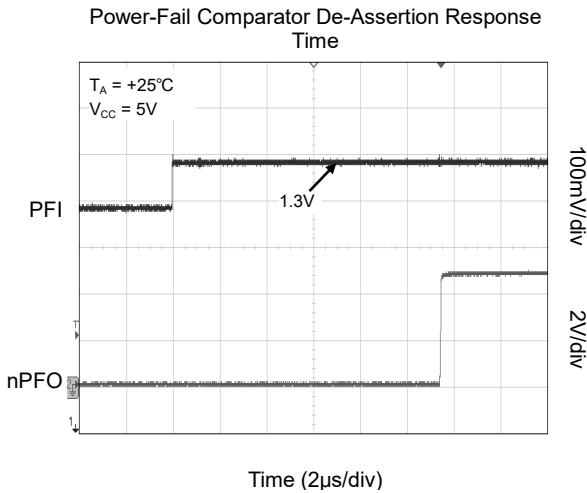
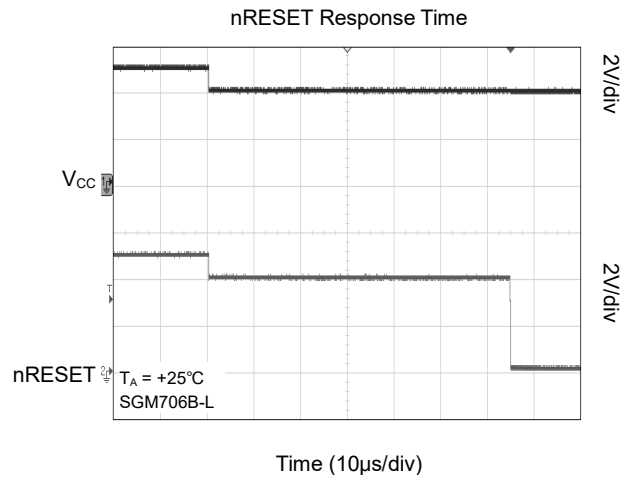
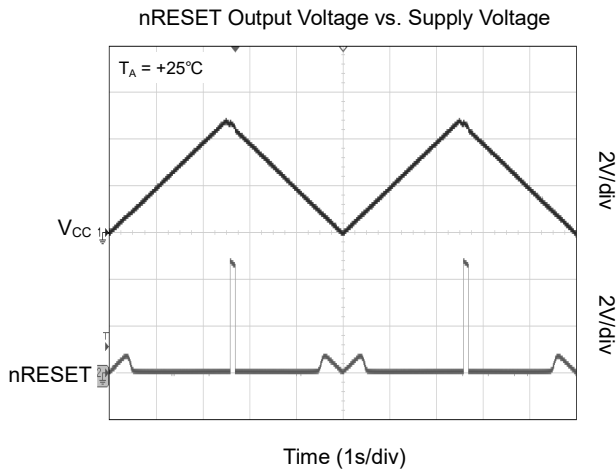

TYPICAL PERFORMANCE CHARACTERISTICS (continued)

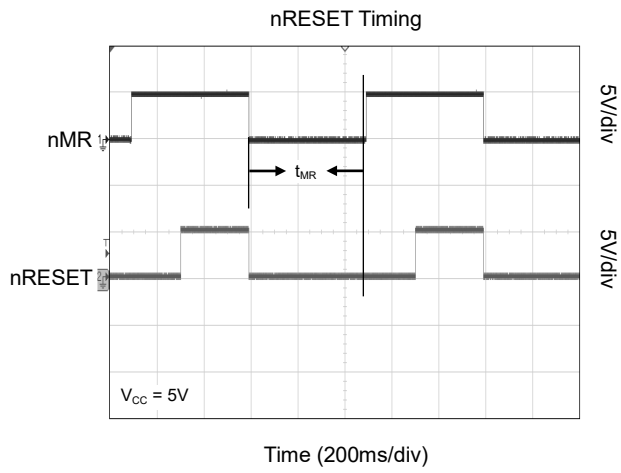

FUNCTIONAL BLOCK DIAGRAM

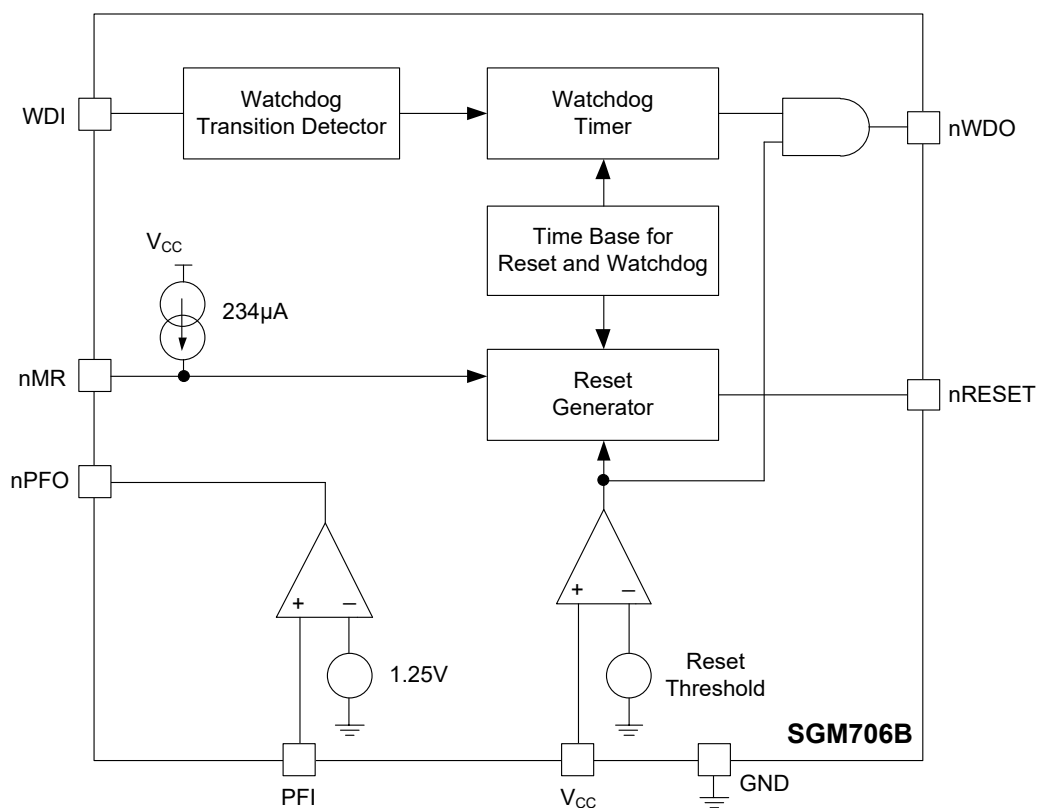

REVISION HISTORY

NOTE: Page numbers for previous revisions may differ from page numbers in the current version.

JANUARY 2021 – REV.A.1 to REV.A.2	Page
Changed Electrical Characteristics section	6, 7

JUNE 2020 – REV.A to REV.A.1	Page
Added UTDFN-1.5×1.5-8L Package	All

Changes from Original (DECEMBER 2018) to REV.A	
Changed from product preview to production data.....	All

PACKAGE OUTLINE DIMENSIONS

UTDFN-1.5x1.5-8L

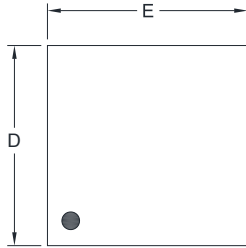

TOP VIEW

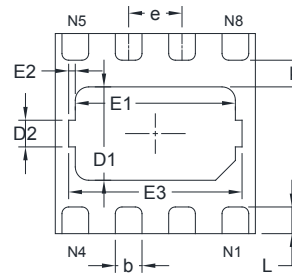

BOTTOM VIEW

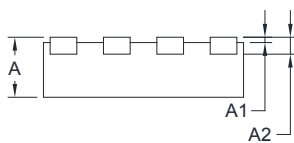

SIDE VIEW

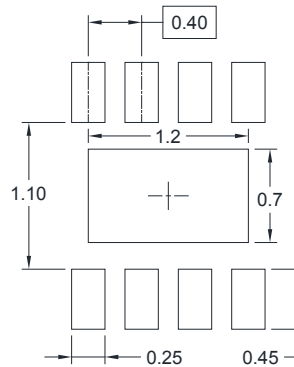

RECOMMENDED LAND PATTERN (Unit: mm)

Symbol	Dimensions In Millimeters		Dimensions In Inches	
	MIN	MAX	MIN	MAX
A	0.400	0.500	0.016	0.020
A1	0.000	0.050	0.000	0.002
A2	0.127 REF		0.005 REF	
D	1.450	1.550	0.057	0.061
D1	0.600	0.800	0.024	0.031
D2	0.200 REF		0.008 REF	
E	1.450	1.550	0.057	0.061
E1	1.100	1.300	0.043	0.051
E2	0.050 REF		0.002 REF	
E3	1.200	1.400	0.047	0.055
k	0.200 REF		0.008 REF	
b	0.150	0.250	0.006	0.010
e	0.400 BSC		0.016 BSC	
L	0.150	0.250	0.006	0.010

PACKAGE OUTLINE DIMENSIONS

SOIC-8

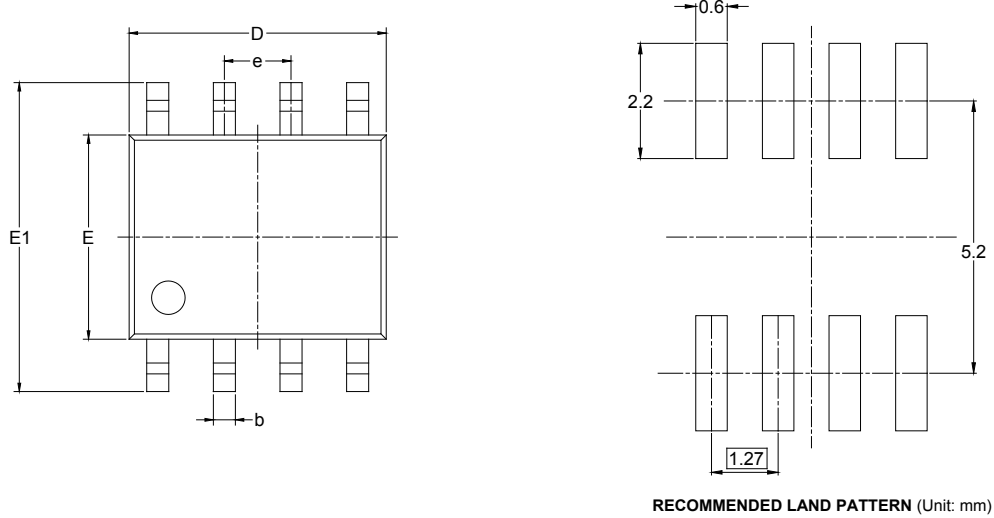

Symbol	Dimensions In Millimeters		Dimensions In Inches	
	MIN	MAX	MIN	MAX
A	1.350	1.750	0.053	0.069
A1	0.100	0.250	0.004	0.010
A2	1.350	1.550	0.053	0.061
b	0.330	0.510	0.013	0.020
c	0.170	0.250	0.006	0.010
D	4.700	5.100	0.185	0.200
E	3.800	4.000	0.150	0.157
E1	5.800	6.200	0.228	0.244
e	1.27 BSC		0.050 BSC	
L	0.400	1.270	0.016	0.050
θ	0°	8°	0°	8°

PACKAGE OUTLINE DIMENSIONS

MSOP-8

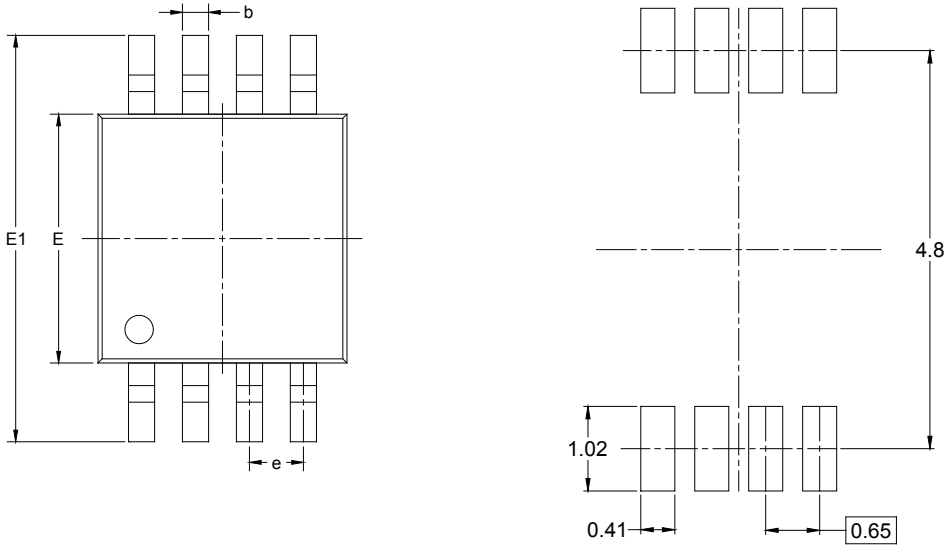

RECOMMENDED LAND PATTERN (Unit: mm)

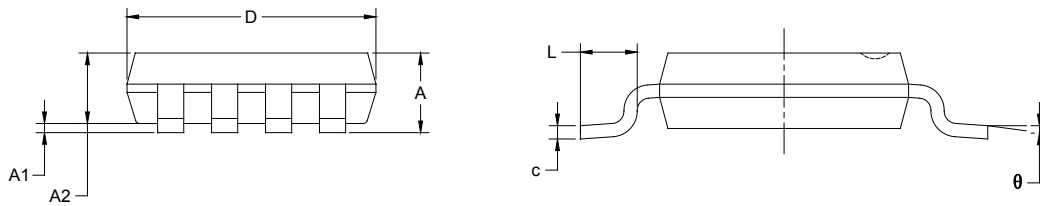

Symbol	Dimensions In Millimeters		Dimensions In Inches	
	MIN	MAX	MIN	MAX
A	0.820	1.100	0.032	0.043
A1	0.020	0.150	0.001	0.006
A2	0.750	0.950	0.030	0.037
b	0.250	0.380	0.010	0.015
c	0.090	0.230	0.004	0.009
D	2.900	3.100	0.114	0.122
E	2.900	3.100	0.114	0.122
E1	4.750	5.050	0.187	0.199
e	0.650 BSC		0.026 BSC	
L	0.400	0.800	0.016	0.031
θ	0°	6°	0°	6°

PACKAGE INFORMATION

TAPE AND REEL INFORMATION

REEL DIMENSIONS



TAPE DIMENSIONS



NOTE: The picture is only for reference. Please make the object as the standard.

KEY PARAMETER LIST OF TAPE AND REEL

Package Type	Reel Diameter	Reel Width W1 (mm)	A0 (mm)	B0 (mm)	K0 (mm)	P0 (mm)	P1 (mm)	P2 (mm)	W (mm)	Pin1 Quadrant
UTDFN-1.5×1.5-8L	7"	9.0	1.70	1.70	0.75	4.0	4.0	2.0	8.0	Q1
SOIC-8	13"	12.4	6.40	5.40	2.10	4.0	8.0	2.0	12.0	Q1
MSOP-8	13"	12.4	5.20	3.30	1.50	4.0	8.0	2.0	12.0	Q1

DD0001

PACKAGE INFORMATION

CARTON BOX DIMENSIONS



NOTE: The picture is only for reference. Please make the object as the standard.

KEY PARAMETER LIST OF CARTON BOX

Reel Type	Length (mm)	Width (mm)	Height (mm)	Pizza/Carton
7" (Option)	368	227	224	8
7"	442	410	224	18
13"	386	280	370	5

DD0002

单击下面可查看定价，库存，交付和生命周期等信息

[>>SGMICRO\(圣邦微电子\)](#)