



## Wi-Fi 6/ 6E TRIPLE BAND EXTERNAL ANTENNA

**Part Numbers: 2108923-1, 2108923-2  
2108923-3, 2108923-4**

### FEATURES & BENEFITS

- Wi-Fi 6, also including Wi-Fi 6E new 6GHz band, Bluetooth and ZigBee
- 90 degree hinge type SMA / RP-SMA connector terminal mount
- No matching circuits required

### SPECIFICATIONS

Frequency Range (MHz)	2400 - 2500	5150 - 5875	5925 – 7125
VSWR	< 1.6:1	< 1.8:1	< 1.9:1
Average Efficiency	82 %	80 %	78 %
Peak Gain	2.3 dBi	3.2 dBi	2.5 dBi
Average Gain	-0.9 dBi	-1.0 dBi	-1.1 dBi
Power Handling	10 Watt cw		
Feed Point Impedance	50 ohms		
Polarization	Linear		
Size	19.91mm x 135.80 mm (Unfolded) 19.91mm x 115.00 mm (Folded)		
Weight	< 12.6 g		
Mounting	SMA Male / RP-SMA Male Terminal mount		
Mating Connectors	SMA Female / RP-SMA Female		
Operating Temperature	-40 to +85°C		
Storage Temperature	-40 to +85°C		
Packaging Specification	Bag & Box		
Hazardous Materials	A certificate of conformance is available from the product page on TE website		
<b>Data measured in free space with hinge at 90 degree bend</b>			

# Wi-Fi 6/ 6E TRIPLE BAND EXTERNAL ANTENNA

Standard Antenna Solutions

## RF DATA

### VSWR

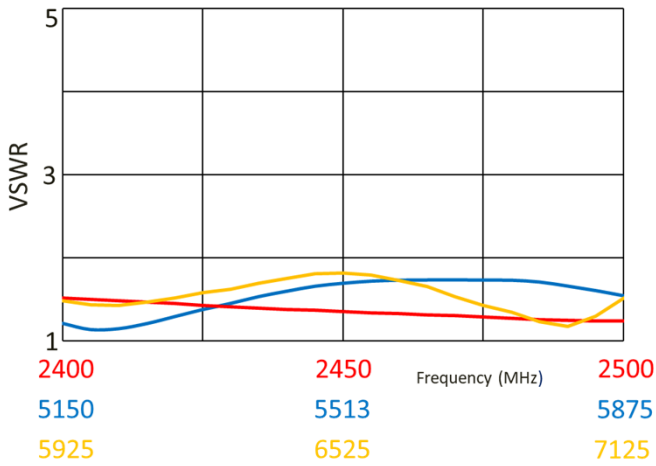

### Return Loss

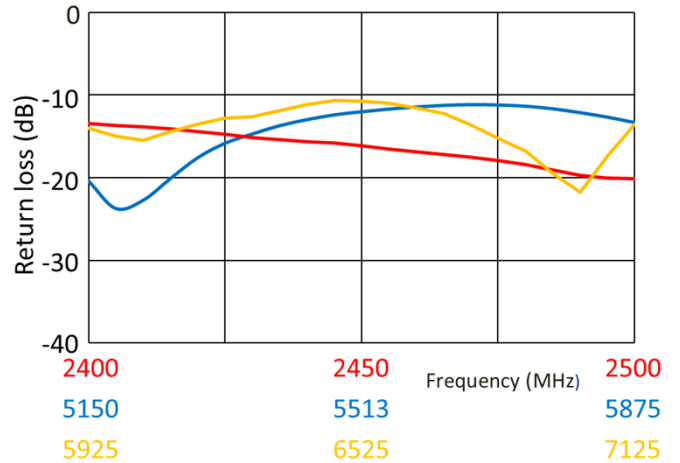

### Efficiency

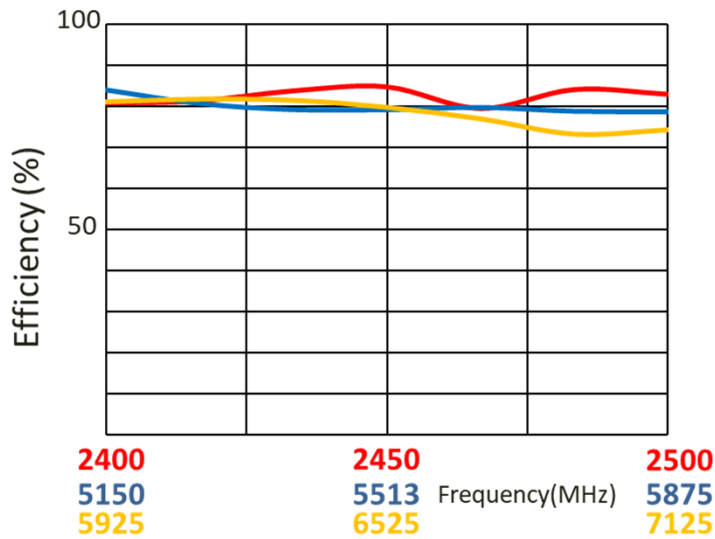

Data measured in free space and on plastic device enclosure

# Wi-Fi 6/ 6E TRIPLE BAND EXTERNAL ANTENNA

Standard Antenna Solutions

## RADIATION PATTERN

### Test setup

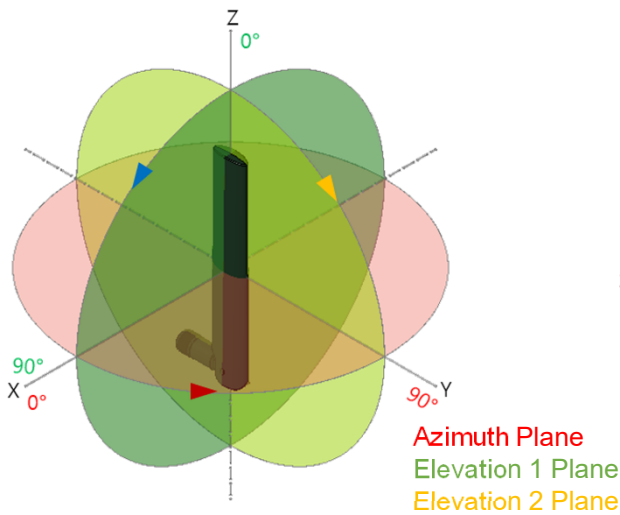

### Azimuth

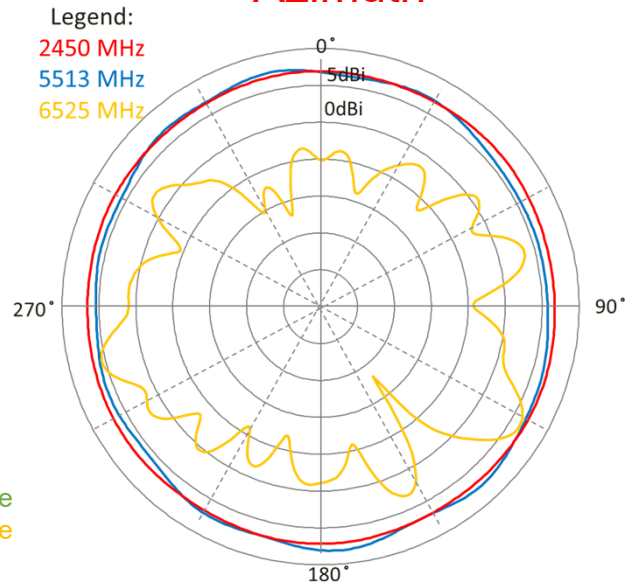

### Elevation 1

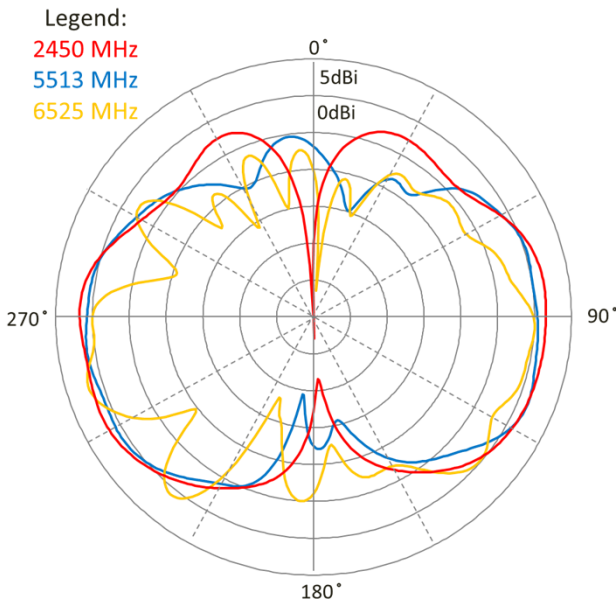

### Elevation 2

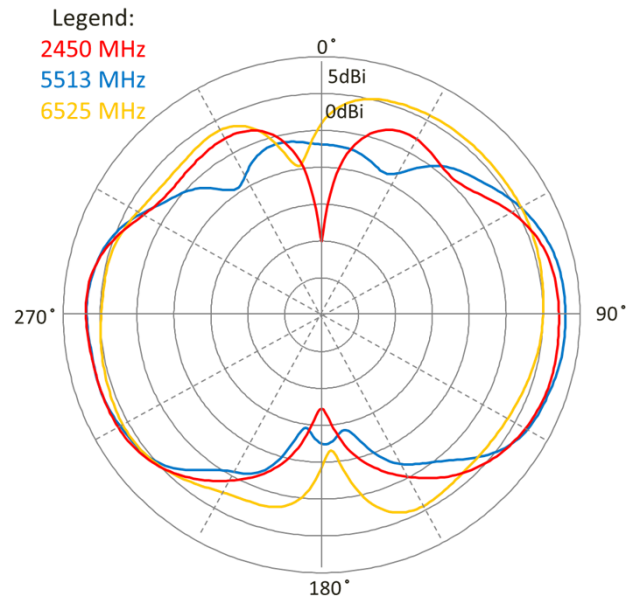

Data measured in free space and on plastic device enclosure

# Wi-Fi 6/ 6E TRIPLE BAND EXTERNAL ANTENNA

Standard Antenna Solutions

## DIMENSIONS

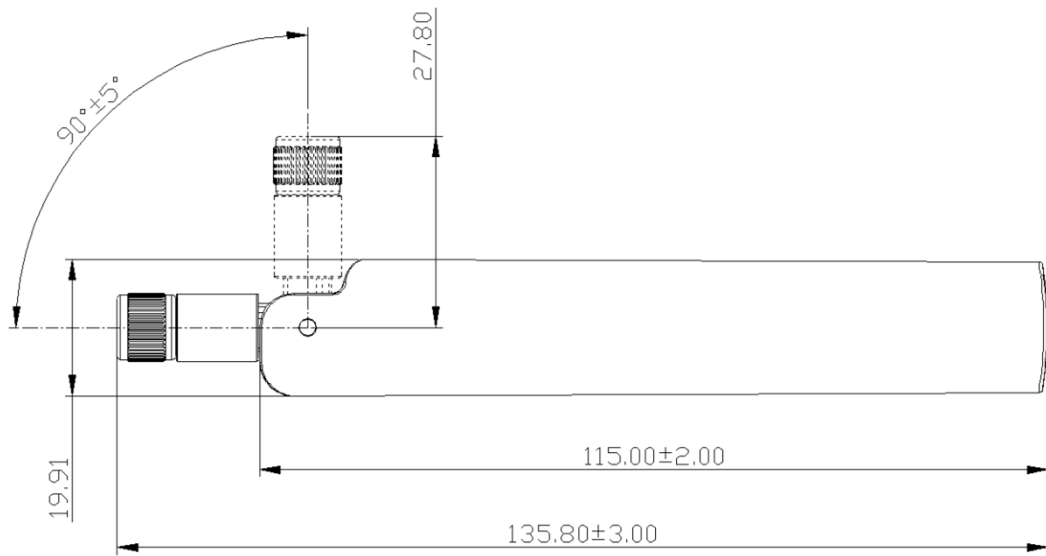







Dimensions: mm  
Diagram is not to scale

# Wi-Fi 6/ 6E TRIPLE BAND EXTERNAL ANTENNA

Standard Antenna Solutions

## MATING COMPONENTS

2108923-4	WHITE	RP-SMA (Male)	2016504-1: RP-SMA jack, right-angle, PCB-mount 	2016693-2: RF CA, RP-SMA bulkhead to UMCC 2016693-4: RF CA, RP-SMA bulkhead to UMCC I 
2108923-3	BLACK	RP-SMA (Male)		2016695-2: RF CA, RP-SMA bulkhead to UMCC IV 2016695-4: RF CA, RP-SMA bulkhead to UMCC IV 
2108923-2	WHITE	SMA (Male)	5-1814400-2: SMA JACK, RIGHT ANGLE 	2016682-2: SMA GEN1 (MHF type),1.13 cable, Length=100mm 2016682-4: SMA GEN1 (MHF type),1.13 cable, Length=200mm 
2108923-1	BLACK	SMA (Male)	5-1814832-2: SMA JACK, VERTICAL 	2016694-2: SMA GEN4 (MHF4 type),1.13 cable, Length=100mm 2016694-4: SMA GEN4 (MHF4 type),1.13 cable, Length=200mm 
PART NUMBER	COLOR	CONNECT OR TYPE	RF CONNECTOR	SMA JACK TO MICRO COAX CABLE ASSEMBLIES
MATING COMPONENTS				

# Wi-Fi 6/ 6E TRIPLE BAND EXTERNAL ANTENNA

Standard Antenna Solutions

## PACKAGING

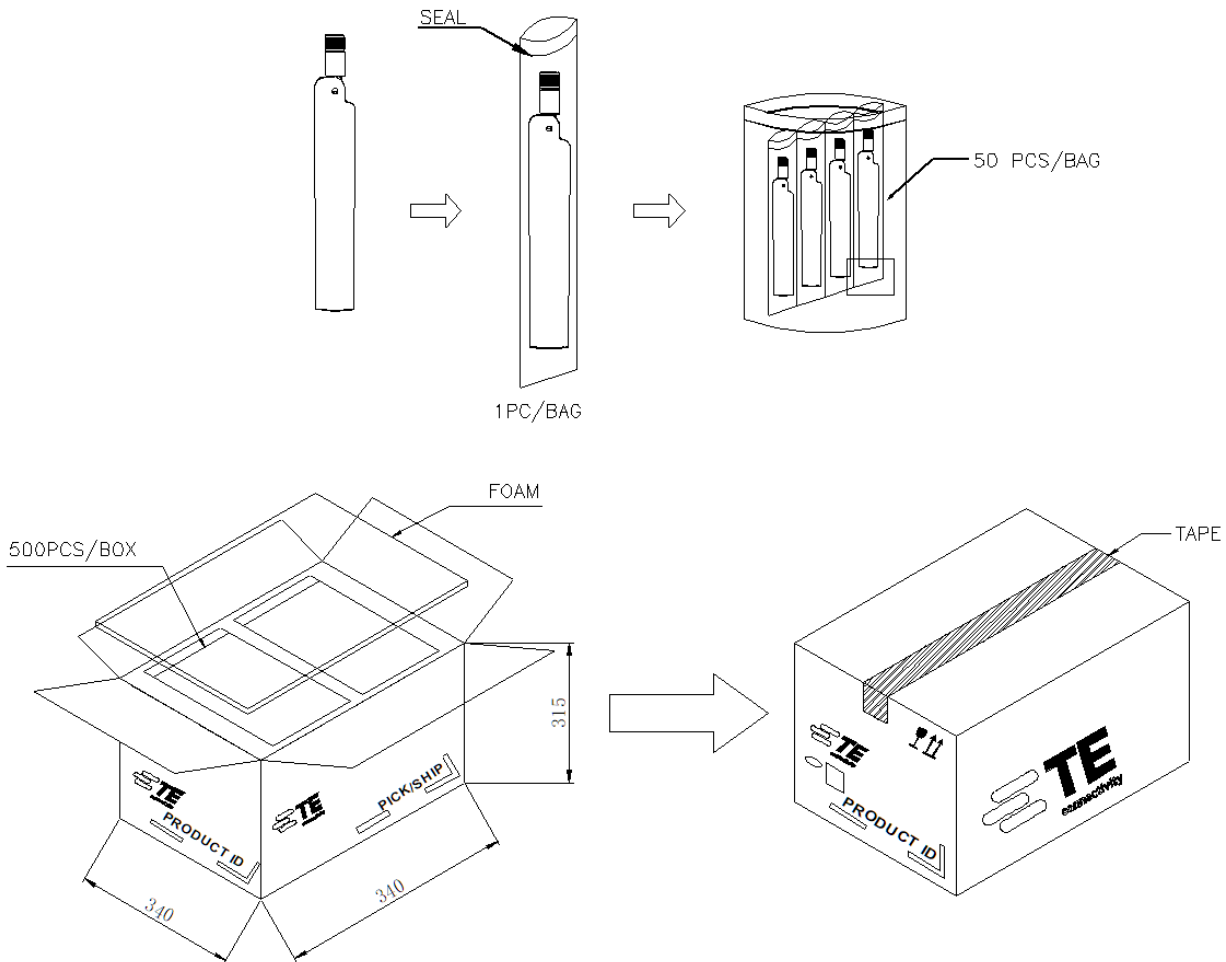

### TE TECHNICAL SUPPORT CENTER

- USA: +1 (800) 522-6752
- Canada: +1 (905) 475-6222
- Mexico: +52 (0) 55-1106-0800
- Latin/S. America: +54 (0) 11-4733-2200
- Germany: +49 (0) 6251-133-1999
- UK: +44 (0) 800-267666
- France: +33 (0) 1-3420-8686
- Netherlands: +31 (0) 73-6246-999
- China: +86 (0) 400-820-6015

For phone numbers in other countries, go to [te.com/support-center](http://te.com/support-center)

### te.com

TE Connectivity, TE Connectivity (logo) are trademarks. All other logos, products and/or company names referred to herein might be trademarks of their respective owners.

The information given herein, including drawings, illustrations and schematics which are intended for illustration purposes only, is believed to be reliable. However, TE Connectivity makes no warranties as to its accuracy or completeness and disclaims any liability in connection with its use. TE Connectivity's obligations shall only be as set forth in TE Connectivity's Standard Terms and Conditions of Sale for this product and in no case will TE Connectivity be liable for any incidental, indirect or consequential damages arising out of the sale, resale, use or misuse of the product. Users of TE Connectivity products should make their own evaluation to determine the suitability of each such product for the specific application.

© 2020 TE Connectivity Ltd. family of companies All Rights Reserved.

04/2021



单击下面可查看定价，库存，交付和生命周期等信息

[>>TE Connectivity\(泰科\)](#)