



Isolation Fly-back Converter PWM method

Output 24W

BM2P061MF-EVK-001

User's Guide

<High Voltage Safety Precautions>

◇ Read all safety precautions before use

Please note that this document covers only the **BM2P061MF** evaluation board (BM2P061MF-EVK-001) and its functions. For additional information, please refer to the datasheet.

To ensure safe operation, please carefully read all precautions before handling the evaluation board



Depending on the configuration of the board and voltages used,

Potentially lethal voltages may be generated.

Therefore, please make sure to read and observe all safety precautions described in the red box below.

Before Use

- [1] Verify that the parts/components are not damaged or missing (i.e. due to the drops).
- [2] Check that there are no conductive foreign objects on the board.
- [3] Be careful when performing soldering on the module and/or evaluation board to ensure that solder splash does not occur.
- [4] Check that there is no condensation or water droplets on the circuit board.

During Use

- [5] Be careful to not allow conductive objects to come into contact with the board.
- [6] **Brief accidental contact or even bringing your hand close to the board may result in discharge and lead to severe injury or death.**

Therefore, DO NOT touch the board with your bare hands or bring them too close to the board.

In addition, as mentioned above please exercise extreme caution when using conductive tools such as tweezers and screwdrivers.

- [7] If used under conditions beyond its rated voltage, it may cause defects such as short-circuit or, depending on the circumstances, explosion or other permanent damages.
- [8] Be sure to wear insulated gloves when handling is required during operation.

After Use

- [9] The ROHM Evaluation Board contains the circuits which store the high voltage. Since it stores the charges even after the connected power circuits are cut, please discharge the electricity after using it, and please deal with it after confirming such electric discharge.
- [10] Protect against electric shocks by wearing insulated gloves when handling.

This evaluation board is intended for use only in research and development facilities and should be handled **only by qualified personnel familiar with all safety and operating procedures.**

We recommend carrying out operation in a safe environment that includes the use of high voltage signage at all entrances, safety interlocks, and protective glasses.

AC/DC Converter

Flyback Type PWM Mode Isolated 5 V 2 A 12 V 1 A Non-Isolated 18.7 V 0.1 A 24 W BM2P061MF Evaluation Board BM2P061MF-EVK-001

General Description

The evaluation board outputs an isolated 5 V voltage, an isolated 12 V voltage and a non-isolated 18.7 V output from a 90 Vac to 264 Vac input. The maximum output power can output 24W.

BM2P061MF which is PWM method DC/DC converter IC built-in 650 V MOSFET is used.

Low on-resistance 1.0 Ω 650 V MOSFET built-in contributes to high efficiency (84.5 % typ).

PWM controller for AC / DC power supplies, the BM2P061MF provides the optimum system for all products with outlets.



Figure 1. BM2P061MF-EVK-001

Performance Specification

Not guarantee the characteristics is representative value.

Unless otherwise specified $V_{IN} = 230 \text{ Vac}$, $I_{OUT5} = 2 \text{ A}$ $I_{OUT12} = 1 \text{ A}$ $I_{OUT18} = 0.1 \text{ A}$, $T_a = 25 \text{ }^\circ\text{C}$

Parameter	Symbol	Min	Typ	Max	Units	Conditions
Input Voltage Range	V_{IN}	90	230	264	V	
Input Frequency	f_{LINE}	47	-	63	Hz	
Output Voltage 1	V_{OUT5}	4.8	5.0	5.2	V	
Output Current Range 1 <i>(Note 1)</i>	I_{OUT5}	0.005	-	2.0	A	
Output Ripple Voltage 1 <i>(Note 1)</i>	V_{RIPPLE}		0.06	0.1	Vpp	
Output Voltage 2	V_{OUT12}	10.6	11.9	13.2	V	
Output Current Range 2	I_{OUT12}	0.05		1.0	A	
Output Ripple Voltage 2 <i>(Note 1)</i>	$V_{RIPPLE12}$		0.08	0.24	Vpp	
Output Voltage 3	V_{OUT18}	16.0	18.7	20.3	V	
Output Current Range 3	I_{OUT18}	0.02		0.1	A	
Output Ripple Voltage 3 <i>(Note 1)</i>	$V_{RIPPLE18}$		0.08	0.35	Vpp	
Maximum Output Power	P_{OUT}			24.0	W	
Standby Input Power	P_{INSTBY}	-	31	100	mW	$I_{OUT} = 0 \text{ A}$ $V_{IN} = 230 \text{ V}$
Power supply efficiency	η	80.0	84.5	-	%	
Operating Temperature		-10	+25	+65	$^\circ\text{C}$	

(Note 1) Not include spikes noise.

Derating

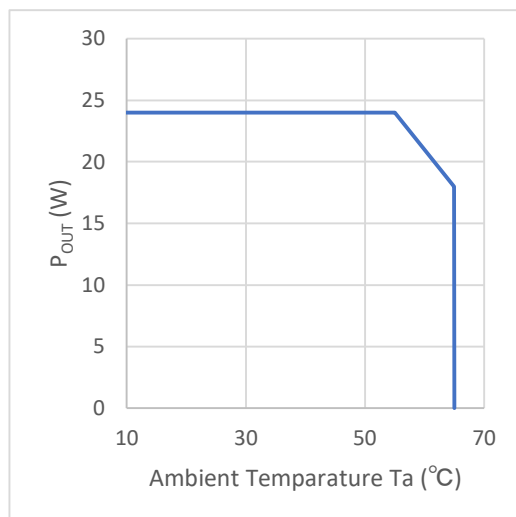

Figure 2. Temperature derating curve

Operation Procedure

1. Operation Equipment

- (1) AC power supply (90 Vac to 264 Vac, 100 W or more)
- (2) Load equipment (2 A at maximum value)
- (3) DC voltmeter

2. Connect method

- (1) Preset the AC power to 90 Vac to 264 Vac and turn off the power output.
- (2) Set the load below the rated current of each output to disable the load.
- (3) Connect the N pin of the power supply to the CN1-1: AC (N) pin and the L pin to the CN1-2: AC (L) pin with a pair of wires.
- (4) Connect the positive pin of each load to each VOUT pin and each negative pin to the GND pin with a pair of wires.
- (5) When connecting a power meter, connect as follows. (For details, refer to the User's Manual of the electricity meter you are using.)
- (6) Connect the positive pin of a DC voltmeter to each VOUT pin and the negative pin to each GND pin for each output voltage measurement.
- (7) AC power supply switch is ON.
- (8) Make sure that the DC voltmeter reading is at the set voltage (5.0 V).
- (9) Electronic load switch is ON.

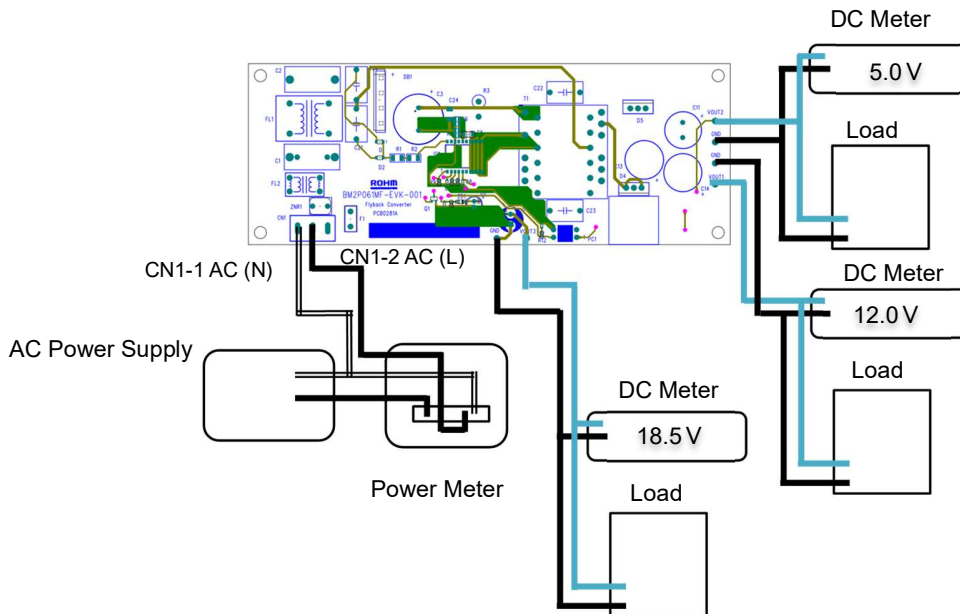

Figure 3. Diagram of How to Connect

BM2P061MF General Description

Features

- AC Low Voltage Protection Function (AC UVLO)
- X Capacitor Discharge Function
- VCC Pin Low Voltage Protection (VCC UVLO)
- PWM Type Current Mode Control
- Frequency Reduction Function
- Burst Operation at Light Load
- External Burst voltage setting function
- Minimum ON width adjustment at light load
- Soft Start Function
- FB Pin Overload Protection Function (FB OLP)
- Over Current Protection Function by cycle
- Over Current Compensation by AC voltage detection.
- External Stop Function
- Dynamic Over Current Protection
- Leading Edge Blanking

Key Specifications

- Operation Power Supply Voltage Range
VCC Pin Voltage: 11 V to 60 V
- DRAIN Pin Voltage: 650 V (Max)
- Current at Switching Operation: 850 μA (Typ)
- Current at Burst Operation: 400 μA (Typ)
- Switching Frequency: 65 kHz (Typ)
- MOSFET ON Resistor: 1.0 Ω (Typ)
- Operation Temperature Range: -40 °C to +105 °C

Package

SOP20A

W (Typ) x D (Typ) x H (Max)

12.8 mm x 10.3 mm x 2.65 mm



Applications

AC Adapters, Each Household Applications and Power Supplies for Motor

Pin Configuration

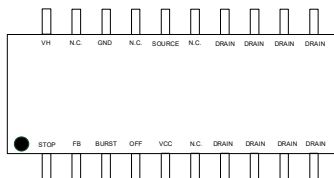

Figure 4. Pin Configuration

Pin Descriptions

No.	Pin name	I/O	Function	No.	Pin name	I/O	Function
1	STOP	I	External stop pin	11	DRAIN	I/O	MOSFET Drain pin
2	FB	I/O	Feedback pin	12	DRAIN	I/O	MOSFET Drain pin
3	BURST	I	Burst setting pin	13	DRAIN	I/O	MOSFET Drain pin
4	OFF	I	MIN on setting pin	14	DRAIN	I/O	MOSFET Drain pin
5	VCC	I/O	Power supply input pin	15	N.C.	-	No connection
6	N.C.	-	No connection	16	SOURCE	I/O	MOSFET source pin
7	DRAIN	I/O	MOSFET Drain pin	17	N.C.	-	No connection
8	DRAIN	I/O	MOSFET Drain pin	18	GND	I/O	GND pin
9	DRAIN	I/O	MOSFET Drain pin	19	N.C.	-	No connection
10	DRAIN	I/O	MOSFET Drain pin	20	VH	I	AC voltage start-up pin

Measurement Data

1. Load Regulation

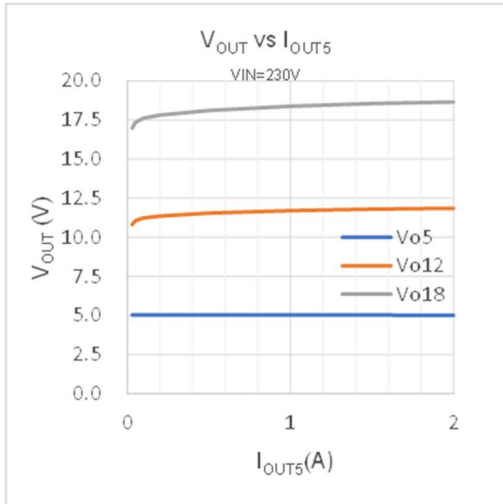

Figure 5. Output Voltage vs Output Current (I_{OUT5})

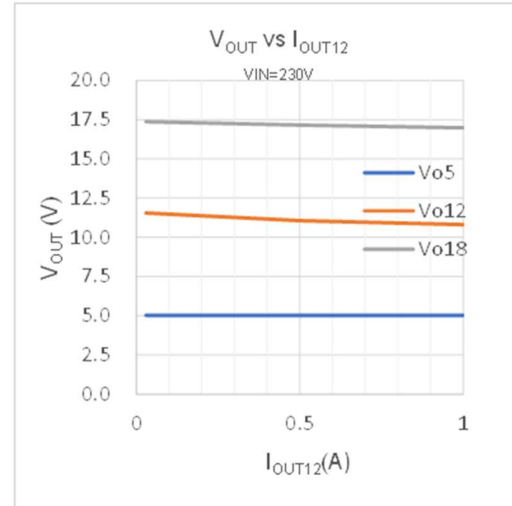

Figure 6. Output Voltage vs Output Current (I_{OUT12})

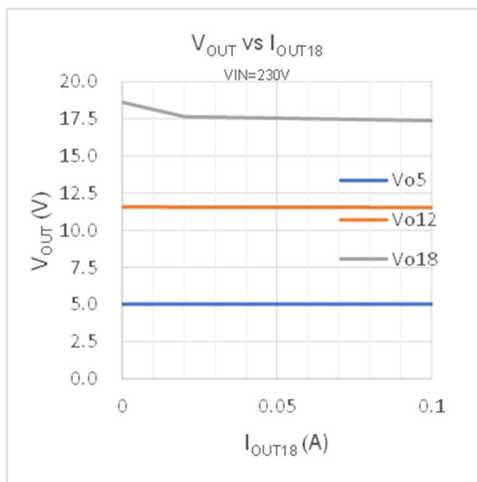

Figure 7. Output Voltage vs Output Current (I_{OUT18})

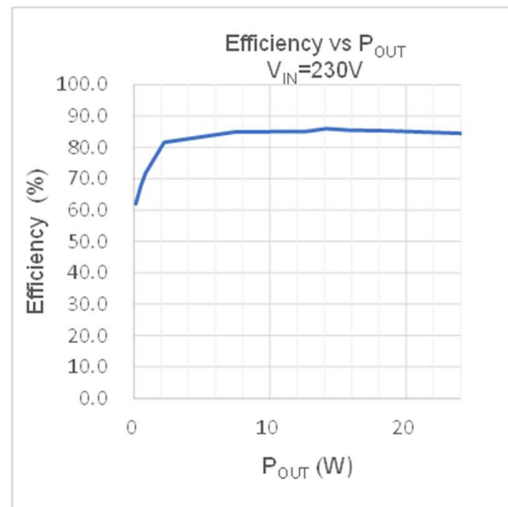

Figure 8. Efficiency vs Output Power

Measurement Data – continued

2. Line Regulation

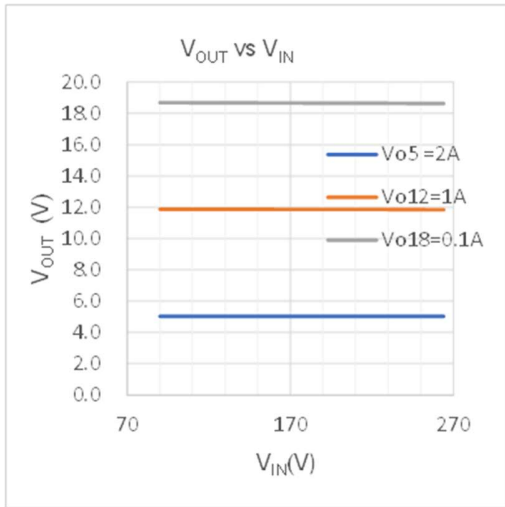

Figure 9. Output Voltage vs Input Voltage

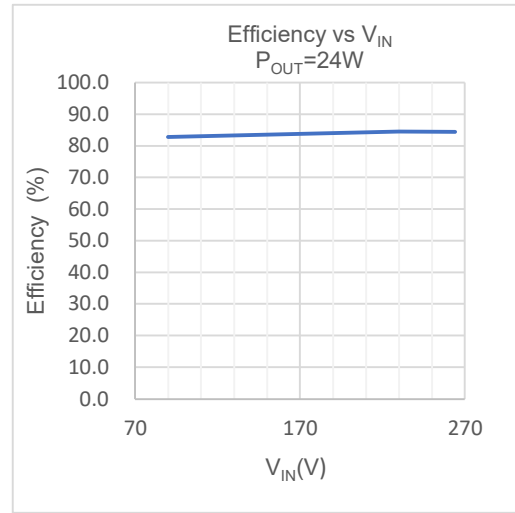

Figure 10. Efficiency vs Input Voltage

3. Switching Frequency

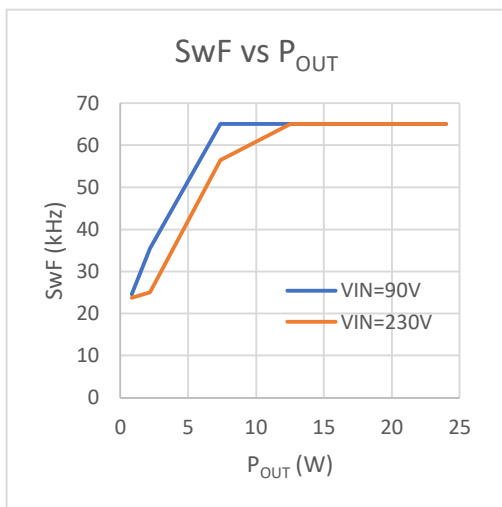

Figure 11. Frequency vs Output Power

Measurement Data – continued

4. Input Voltage Slowup

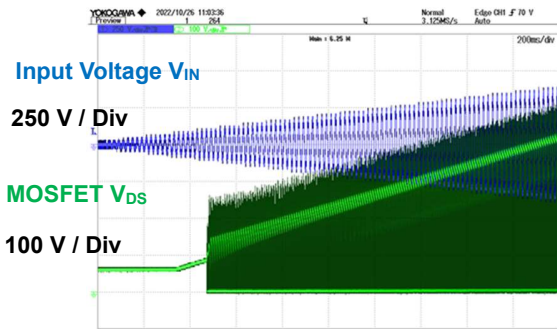

Figure 12. VIN = 0 V to 230V Rated load

5. Input Capacitor (C1) Discharge operation

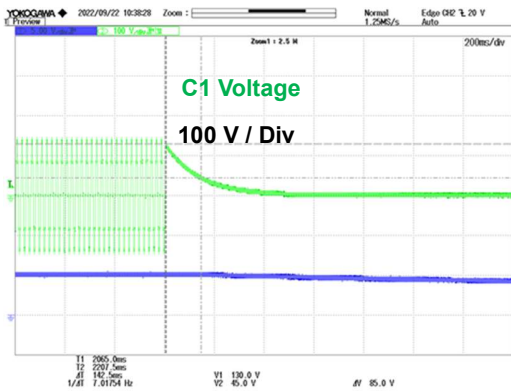

Figure 13. C1 Voltage

Measurement Data – continued

6. Switching Wave Form

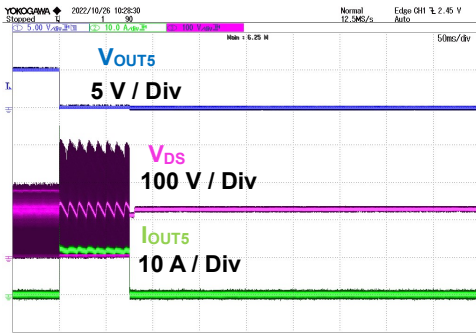

Figure 14. Drain Voltage $V_{IN} = 90 \text{ Vac}$, V_{OUT5} Shorted

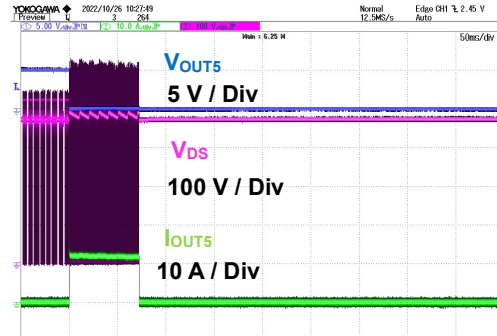

Figure 15. Drain Voltage $V_{IN} = 264 \text{ Vac}$, V_{OUT5} Shorted

7. Startup Wave Form

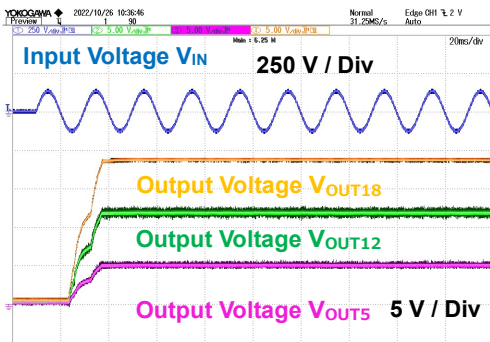

Figure 16. $V_{IN} = 90 \text{ Vac}$, Rated load

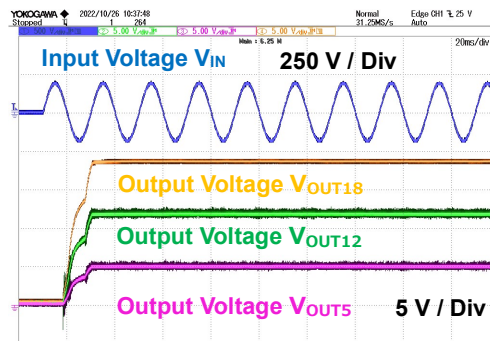

Figure 17. $V_{IN} = 264 \text{ Vac}$, Rated load

Measurement Data – continued

8. Dynamic Load Fluctuation

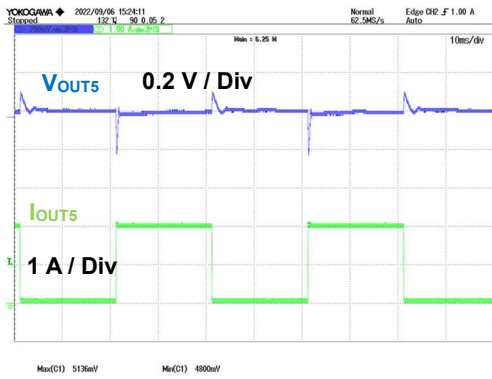

Figure 18. $V_{IN} = 90 \text{ Vac}$, $I_{OUT5} = \text{switch } 0.05 \text{ A} / 2.0 \text{ A}$

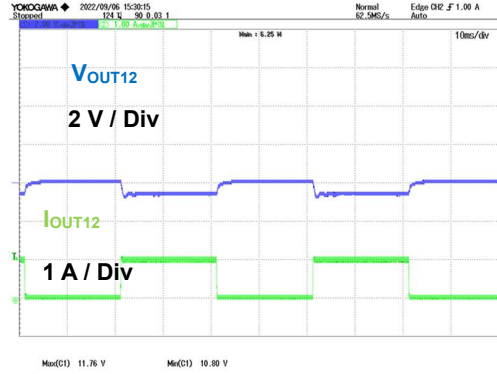

Figure 19. $V_{IN} = 90 \text{ Vac}$, $I_{OUT12} = \text{switch } 0.03 \text{ A} / 1.0 \text{ A}$

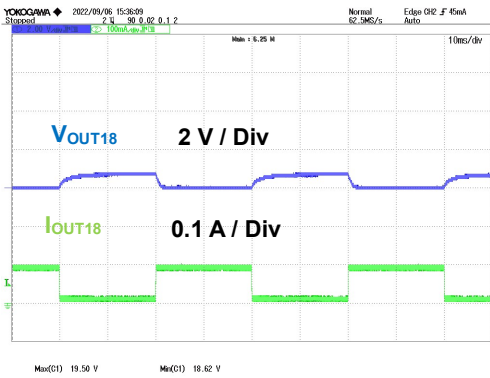

Figure 20. $V_{IN} = 90 \text{ Vac}$, $I_{OUT18} = \text{switch } 0.02 \text{ A} / 0.1 \text{ A}$

Measurement Data – continued

9. Output Voltage Ripple Wave Form

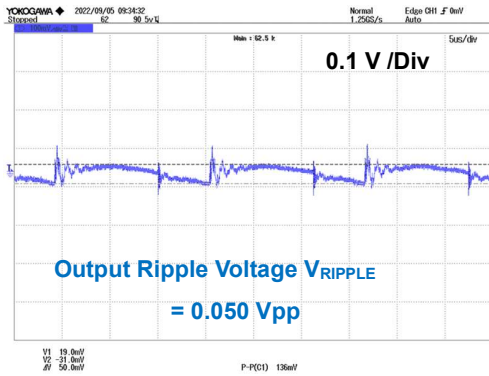

Figure 21. $V_{IN} = 90 \text{ Vac}$, $I_{OUT5} = 2.0 \text{ A}$

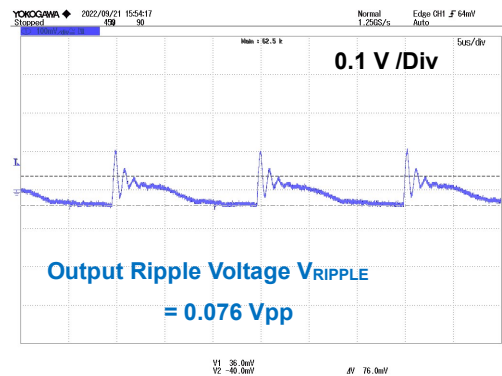

Figure 22. $V_{IN} = 90 \text{ Vac}$, $I_{OUT12} = 1.0 \text{ A}$

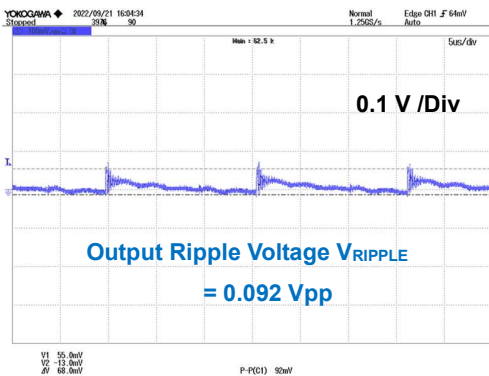

Figure 23. $V_{IN} = 90 \text{ Vac}$, $I_{OUT18} = 0.1 \text{ A}$

Measurement Data – continued**10. Temperature of Parts Surface**

They are measured after 15 minutes from applying a power supply.

Table 1. Surface Temperature of Parts ($T_a = 23.6\text{ }^\circ\text{C}$)

Part	Condition	
	$V_{IN} = 90\text{ Vac, Rated Load}$	$V_{IN} = 264\text{ Vac, Rated Load}$
IC1	61.1 °C	57.7 °C
Diode D1	65.5 °C	64.6 °C

Measurement Data – continued

11. EMI Conducted Emission: CISPR22 Pub 22 Class B

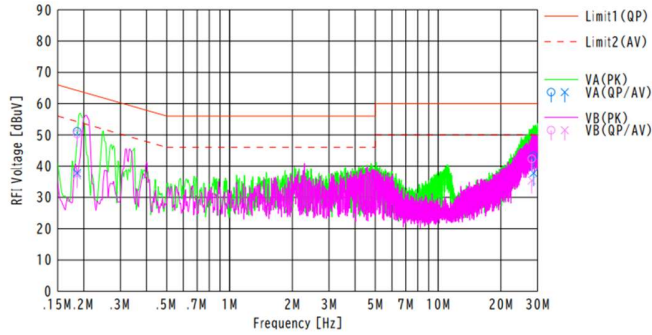

QP margin: 13.1dB
 AVE margin: 6.4dB

Figure 24. V_{IN} : 115 Vac / 60 Hz, I_{OUT5} :2 A I_{OUT12} :1 A I_{OUT18} :0.1 A

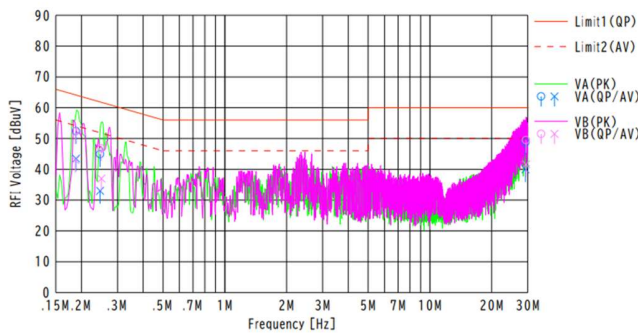

QP margin: 10.5dB
 AVE margin: 8.4dB

Figure 25. V_{IN} : 230 Vac / 50 Hz, I_{OUT5} :2 A I_{OUT12} :1 A I_{OUT18} :0.1 A

Schematics

$V_{IN} = 90 \text{ Vac to } 264 \text{ Vac}$, $V_{OUT5} = 5 \text{ V} / 2 \text{ A}$ $V_{OUT12} = 1 \text{ A}$ $V_{OUT18} = 0.1 \text{ A}$

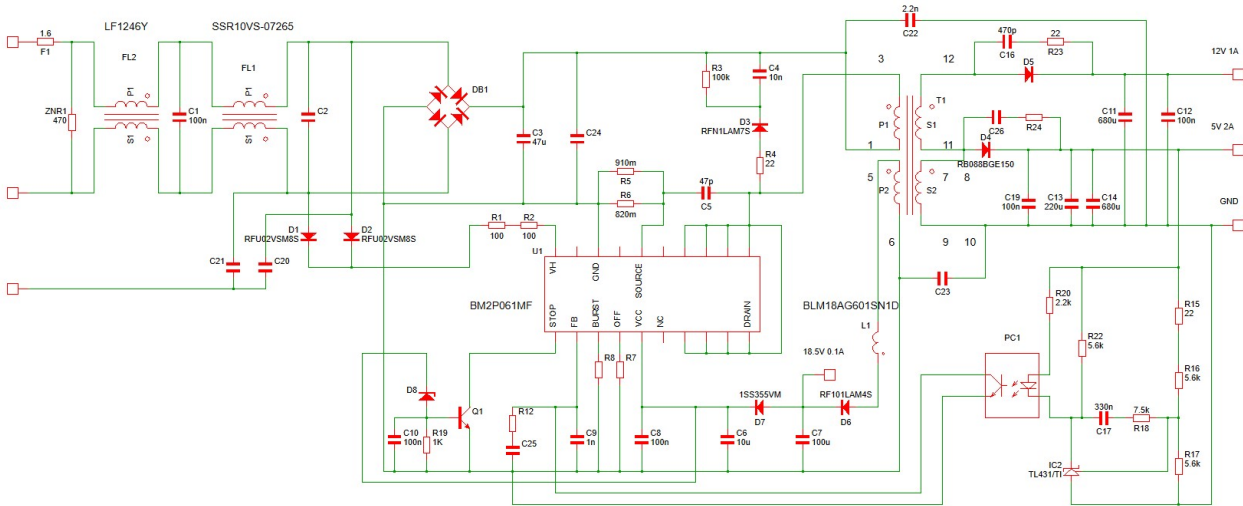

Figure 26. BM2P061MF-EVK-001 Schematics

Parts List

Items	Specifications	Parts name	Manufacture
C1	0.1uF/310V	890334025017CS	WURTH
C3	47 uF/450V	450BXW47MEFR18×20	Rubycon
C4	10nF/500V	885342208009	WURTH
C5	47pF/1 kV	GRM31A7U3A470JW31D	MURATA
C6	10uF/50V	860020672010	WURTH
C7	100uF/50V	860080674009	WURTH
C8,C10,C12,C19	0.1uF/100V	HMK107B7104KA-T	TaiyoYuden
C9	1000pF/50V	HMK107B7102KA-T	TaiyoYuden
C11	680uF/35V	860080578019	WURTH
C13	220uF/35V	APSG250ELL221MHB5S	CHIME-CON
C14	680uF/35V	860080578019	WURTH
C16	470pF/250V	885342208023	WURTH
C17	0.33uF/25V	TMK107BJ334KA-T	TaiyoYuden
C22	2200 pF, Y1:300 Vac	DE1E3RA222MA4BP01F	MURATA
C2,C18,C20,C21,C23,C24,C25,C26	-	Non-Mounted	
CN1		B03P-NV	JST
D1,D2	800 V 0.2 A	RFU02VSM8S	ROHM
D3	FRD 700 V 1 A	RFN1LAM7S	ROHM
D4	SBD 150 V 10 A	RB088T150NZ	ROHM
D5	SBD 200 V 20 A	STPS20200CFP	ST
D6	FRD 400 V 1 A	RF101LAM4S	ROHM
D7	90V 0.1A	1SS355VMTE-17	ROHM
DB1	600V	D2SBA60-7000	Shidengen
F1	1 A, 300 V	36911000000	LITTELFUSE
FL1	0.7A 26.5mH	SSR10VS-07265	TOKIN
FL2		LF1246Y	ALPHA TRANS
IC1		BM2P061MF	ROHM
IC2		TL431BIDBZT	TI
L1		BLM18AG601SN1D	MURATA
PC1		LTV-817	LITE-ON
Q1		2SCR523UB	ROHM
R1,R2	100	ESR18EZPJ101	ROHM
R3	100k/2W	ERG2SJ104E	Panasonic
R4	22	MCR18EZPJ220	ROHM
R5	0.91	LTR18EZPFLR910	ROHM
R6	0.82	LTR18EZPFLR820	ROHM
R15	22	MCR03EZPJ220	ROHM
R16,R17	5.6k	MCR03EZPF5601	ROHM
R18	7.5k	MCR03EZPJ752	ROHM
R19	1k	MCR03EZPJ102	ROHM
R20	2.2k	MCR03EZPJ222	ROHM
R22	5.6k	MCR03EZPJ562	ROHM
R23	22	ESR18EZPJ220	ROHM
R7,R8,R12,R24	-	Non-Mounted	
T1		XE2637YA	ALPHA TRANS
ZD1	27V	UDZV27B	ROHM
HEAT1	20.0K/W	OSH-1625-SFL	RYOSAN
HEAT2	32.3K/W	OSH-1525-SFL	RYOSAN
TP1.TP2,TP3,TP4,TP5,TP6		CD-10-15	MAC8
PCB		PCB0281A	

Materials may be changed without notifying.

Layout

Size: 160 mm x 55 mm

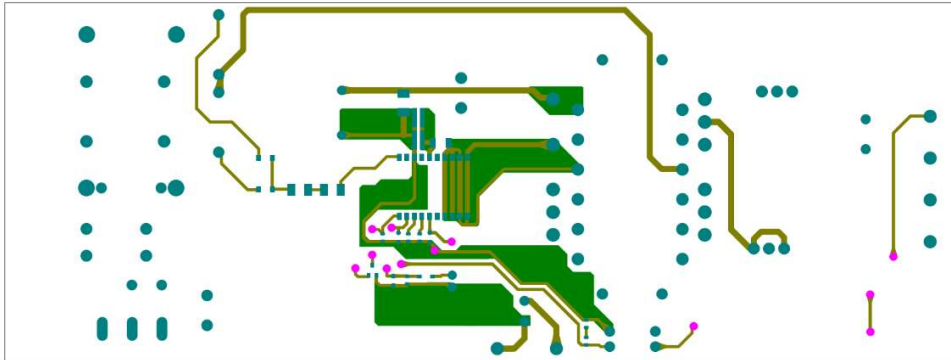

Figure 27. TOP Layout (Top view)



Figure 28. Bottom Layout (Top View)

Specification of the Transformer

Manufacture Alphatrans Co., Ltd. (1-7-2, Bakurou-cho, Chuo-ku, Osaka City, 541-0059, Japan)
 http://www.alphatrans.jp/

Product Name: XE2637Y_A
 Bobbin: 12PIN
 Core: ER28

- Primary Inductance: 493 μ H \pm 10 %
 (100 kHz, 1 V)
- Withstand Voltage
 - Between Primary and Secondary: AC1500 V
 - Between Primary and Core: AC1500 V
 - Between Secondary and Core: AC500 V
- Insulation Resistance 100 M Ω or more (DC500 V)

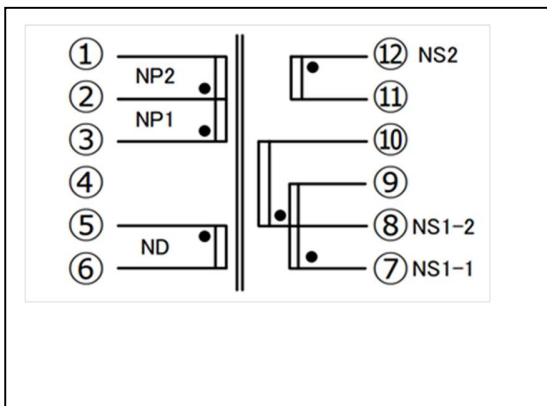

Figure 29. Circuit Diagram

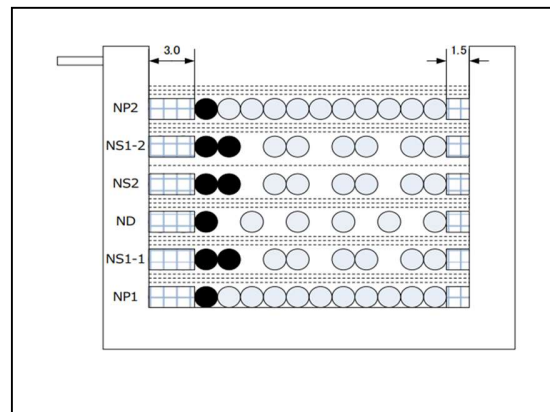

Figure 30. Structure Diagram

Table 2. Product Specification of XE2637Y_A

No.	Transformer	Winding Pin		Wire	Turn Number	Tape Layer	Wire Specification
		Start	Finish				
1	NP1	3	2	2UEW / Φ 0.40 \times 1	24	3	COMPACT
2	NS1-1	7	9	2UEW / Φ 0.45 \times 2	5	3	COMPACT
3	ND	5	6	2UEW / Φ 0.20 \times 1	17	3	COMPACT
4	NS2	12	11	2UEW / Φ 0.45 \times 2	6	1	COMPACT
5	NS1-2	8	10	2UEW / Φ 0.45 \times 2	5	3	COMPACT
6	NP2	2	1	2UEW / Φ 0.40 \times 1	25	3	COMPACT

Revision History

Date	Rev.	Changes
23.November.2022	001	New Release

Notes

- 1) The information contained herein is subject to change without notice.
- 2) Before you use our Products, please contact our sales representative and verify the latest specifications :
- 3) Although ROHM is continuously working to improve product reliability and quality, semiconductors can break down and malfunction due to various factors.
Therefore, in order to prevent personal injury or fire arising from failure, please take safety measures such as complying with the derating characteristics, implementing redundant and fire prevention designs, and utilizing backups and fail-safe procedures. ROHM shall have no responsibility for any damages arising out of the use of our Products beyond the rating specified by ROHM.
- 4) Examples of application circuits, circuit constants and any other information contained herein are provided only to illustrate the standard usage and operations of the Products. The peripheral conditions must be taken into account when designing circuits for mass production.
- 5) The technical information specified herein is intended only to show the typical functions of and examples of application circuits for the Products. ROHM does not grant you, explicitly or implicitly, any license to use or exercise intellectual property or other rights held by ROHM or any other parties. ROHM shall have no responsibility whatsoever for any dispute arising out of the use of such technical information.
- 6) The Products specified in this document are not designed to be radiation tolerant.
- 7) For use of our Products in applications requiring a high degree of reliability (as exemplified below), please contact and consult with a ROHM representative : transportation equipment (i.e. cars, ships, trains), primary communication equipment, traffic lights, fire/crime prevention, safety equipment, medical systems, servers, solar cells, and power transmission systems.
- 8) Do not use our Products in applications requiring extremely high reliability, such as aerospace equipment, nuclear power control systems, and submarine repeaters.
- 9) ROHM shall have no responsibility for any damages or injury arising from non-compliance with the recommended usage conditions and specifications contained herein.
- 10) ROHM has used reasonable care to ensure the accuracy of the information contained in this document. However, ROHM does not warrants that such information is error-free, and ROHM shall have no responsibility for any damages arising from any inaccuracy or misprint of such information.
- 11) Please use the Products in accordance with any applicable environmental laws and regulations, such as the RoHS Directive. For more details, including RoHS compatibility, please contact a ROHM sales office. ROHM shall have no responsibility for any damages or losses resulting non-compliance with any applicable laws or regulations.
- 12) When providing our Products and technologies contained in this document to other countries, you must abide by the procedures and provisions stipulated in all applicable export laws and regulations, including without limitation the US Export Administration Regulations and the Foreign Exchange and Foreign Trade Act.
- 13) This document, in part or in whole, may not be reprinted or reproduced without prior consent of ROHM.



Thank you for your accessing to ROHM product informations.
More detail product informations and catalogs are available, please contact us.

ROHM Customer Support System

<http://www.rohm.com/contact/>

单击下面可查看定价，库存，交付和生命周期等信息

[>>ROHM Semiconductor\(罗姆\)](#)