



SAW Components

SAW Duplexer

WCDMA Band 4/ CDMA 1x AWS Band

Series/type:	B8517
Ordering code:	B39212B8517P810
Date:	June 4, 2013
Version:	2.0

© EPCOS AG 2015. Reproduction, publication and dissemination of this publication, enclosures hereto and the information contained therein without EPCOS' prior express consent is prohibited.

EPCOS AG is a TDK Group Company.

Data Sheet

Application

- Low-loss SAW duplexer for mobile telephone W-CDMA Band 4 (UMTS) systems
- Low insertion attenuation
- Low amplitude ripple
- Usable passband 45 MHz
- High isolation between Tx and Rx

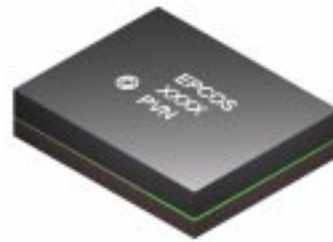
Features

- Package size 2.0 * 1.6 mm²
- max. Package height 0.47 mm
- RoHS compatible
- Approximate weight 0.005 g
- Package for **Surface Mount Technology (SMT)**
- Ni terminals, Au-plated
- **Electrostatic Sensitive Device (ESD)**
- Fully matched by integrated matching network
- **Moisture Sensitive Level 3**

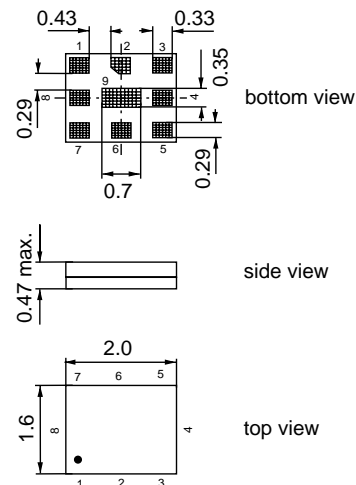
Pin configuration

- 3 Tx input
- 6 Antenna
- 1 Rx output
- 2, 4, 5, 7, 8, 9 To be grounded

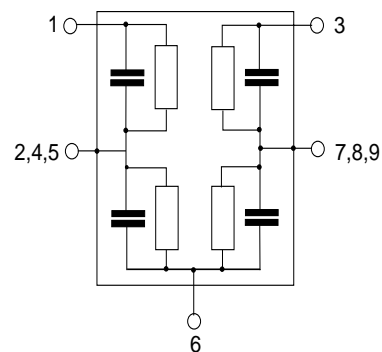

Please read *cautions and warnings and important notes* at the end of this document.

Data Sheet

Characteristics for CDMA 1x AWS Band

Temperature range for specification:	T = -30 °C to +90 °C
TX terminating impedance:	Z _{Tx} = 50 Ω
ANT terminating impedance:	Z _{Ant} = 50 Ω 2.4 nH
RX terminating impedance:	Z _{Rx} = 50 Ω 5.6 nH

		B8517			
Characteristics Tx-Antenna		min.	typ. @ 25 °C	max.	
Center frequency	f _c		1732.5		MHz
Maximum insertion attenuation					
1710.0 ... 1755.0MHz			1.5	2.0	dB
@f _{Carrier} 1712.4 ... 1752.6MHz	α _{W-CDMA} ¹⁾		1.4	1.9	dB
Amplitude ripple (p-p)					
1710.0 ... 1755.0MHz			0.4	1.0	dB
@f _{Carrier} 1712.4 ... 1752.6MHz	Δα _{W-CDMA} ¹⁾		0.4	0.9	dB
Error Vector Magnitude	EVM ²⁾				
@f _{Carrier} 1712.4 ... 1752.6MHz			0.5	2.0	%
Input VSWR (Tx port)					
1710.0 ... 1755.0MHz			1.8	2.2	
Output VSWR (Ant Port)					
1710.0 ... 1755.0MHz			1.7	2.2	
Attenuation	α				
10.0 ... 1559.0MHz		30	47		dB
728.0 ... 764.0MHz		42	46		dB
851.0 ... 894.0MHz		39	44		dB
1559.0 ... 1563.0MHz		40	47		dB
1565.0 ... 1573.0MHz		41	48		dB
1573.0 ... 1577.0MHz		45	51		dB
1577.0 ... 1585.0MHz		42	51		dB
1598.0 ... 1606.0MHz		38	45		dB
1805.0 ... 1880.0MHz		20	47		dB
1930.0 ... 1990.0MHz		42	48		dB
2110.0 ... 2155.0MHz		42	46		dB
@f _{Carrier} 2112.4 ... 2152.6MHz	α _{W-CDMA} ¹⁾	42	47		dB
2400.0 ... 2500.0MHz		32	38		dB
3420.0 ... 3510.0MHz		20	27		dB
4900.0 ... 5265.0MHz		18	28		dB
5265.0 ... 5850.0MHz		14	25		dB

¹⁾ Attenuation of W-CDMA signal (Power Transfer Function). Please, refer to page 6.

²⁾ Error Vector Magnitude (EVM) based on definition given in 3GPP TS 25.141

Please read *cautions and warnings and important notes* at the end of this document.

Data Sheet

Characteristics for CDMA 1x AWS Band

Temperature range for specification:	T = -30 °C to +90 °C
TX terminating impedance:	Z _{Tx} = 50 Ω
ANT terminating impedance:	Z _{Ant} = 50 Ω 2.4 nH
RX terminating impedance:	Z _{Rx} = 50 Ω 5.6 nH

		B8517			
Characteristics Antenna-Rx		min.	typ. @ 25 °C	max.	
Center frequency	f _c		2132.5		MHz
Maximum insertion attenuation					
2110.0 ... 2155.0MHz			1.9	2.3	
@f _{Carrier} 2112.4 ... 2152.6MHz	α _{W-CDMA} ¹⁾		1.8	2.2	dB
Amplitude ripple (p-p)					
2110.0 ... 2155.0MHz			0.4	0.9	
@f _{Carrier} 2112.4 ... 2152.6MHz	Δα _{W-CDMA} ¹⁾		0.4	0.8	dB
Error Vector Magnitude	EVM ²⁾				
@f _{Carrier} 2112.4 ... 2152.6MHz			0.5	2.0	%
Input VSWR					
2110.0 ... 2155.0MHz			1.4	1.8	
Output VSWR					
2110.0 ... 2155.0MHz			1.4	1.8	
Attenuation	α				
1.0 ... 1710.0MHz		40	51		dB
400.0 ... 400.0MHz		50	70		dB
1710.0 ... 1755.0MHz		45	51		dB
@f _{Carrier} 1712.4 ... 1752.6MHz	α _{W-CDMA} ¹⁾	45	51		dB
1755.0 ... 2025.0MHz		15	40		dB
1910.0 ... 1955.0MHz		35	45		dB
2255.0 ... 6000.0MHz		30	39		dB
2400.0 ... 2500.0MHz		40	50		dB
2500.0 ... 3820.0MHz		35	42		dB
3820.0 ... 3910.0MHz		35	42		dB
4220.0 ... 4310.0MHz		34	41		dB
5530.0 ... 5665.0MHz		32	40		dB
5725.0 ... 5875.0MHz		32	40		dB

¹⁾ Attenuation of W-CDMA signal (Power Transfer Function). Please, refer to page 6.

²⁾ Error Vector Magnitude (EVM) based on definition given in 3GPP TS 25.141

Data Sheet

Characteristics for CDMA 1x AWS Band

Temperature range for specification:	T = -30 °C to +90 °C
TX terminating impedance:	Z _{Tx} = 50 Ω
ANT terminating impedance:	Z _{Ant} = 50 Ω 2.4 nH
RX terminating impedance:	Z _{Rx} = 50 Ω 5.6 nH

				B8517			
Characteristics Tx-Rx				min.	typ. @ 25 °C	max.	
Isolation			α				
	1574.0	... 1577.0	MHz	40	63		dB
	1710.0	... 1755.0	MHz	52	56		dB
	1712.4	... 1752.6	MHz α _{W-CDMA} ¹⁾	52	56		dB
	2110.0	... 2155.0	MHz	50	61		dB
	2112.4	... 2152.6	MHz α _{W-CDMA} ¹⁾	50	62		dB
	3410.0	... 3520.0	MHz	20	52		dB
	5120.0	... 5275.0	MHz	20	48		dB

¹⁾ Attenuation of W-CDMA signal (Power Transfer Function). Please, refer to page 6.

Annotation for characteristics section

Attenuation of W-CDMA signal (Power Transfer Function, α_{W-CDMA}) is determined by

$$\int_{-\infty}^{\infty} |S_{ds21}(f)H_{RRC}(f - f_{Carrier})|^2 df$$

with $f_{Carrier}$ according to 3GPP TS 25.101 (e.g. for UMTS pass band, $f_{Carrier}$ ranges from 1712.4 MHz (lowest Tx channel) to 1752.6 MHz (highest Tx channel)). Here, $H_{RRC}(f)$ is the transfer function of the root-raised cosine transmit pulse shaping filter according to 3GPP TS 25.101 with the following normalization:

$$\int_{-\infty}^{\infty} |H_{RRC}(f)|^2 df = 1$$

Maximum Ratings

Storage temperature range	T_{stg}	-40/+90	°C	
DC voltage	V_{DC}	5 ¹⁾	V	
DC impedance to ground		> 100	MΩ	
ESD voltage	V_{ESD}	50 ²⁾	V	machine model, 10 pulses
Input power at				} continuous wave 50 °C, 5000h
1710.0 ... 1755.0 MHz	P_{in}	29	dBm	
elsewhere	P_{in}	10	dBm	

1) min. 168h Damp Heat Steady State acc. to IEC 60068-2-67 Cy.

2) According to JESD22-A115A (machine model), 10 negative and 10 positive pulses.



Power Transfer Function Tx-Ant:

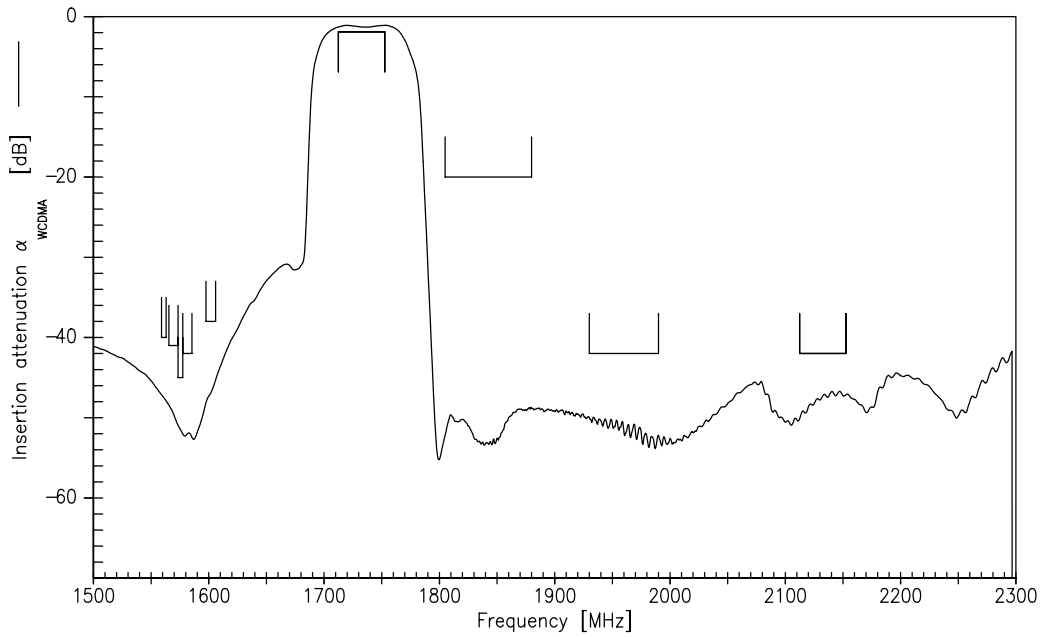

Power Transfer Function Tx-Ant (wideband):

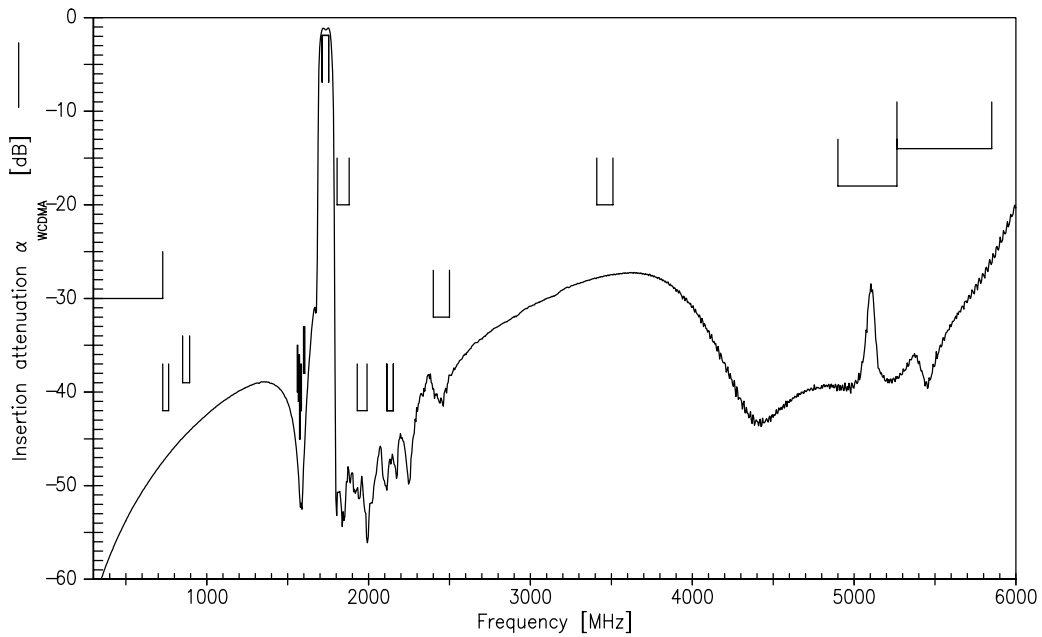

Please read *cautions and warnings* and *important notes* at the end of this document.



Power Transfer Function Ant-Rx:

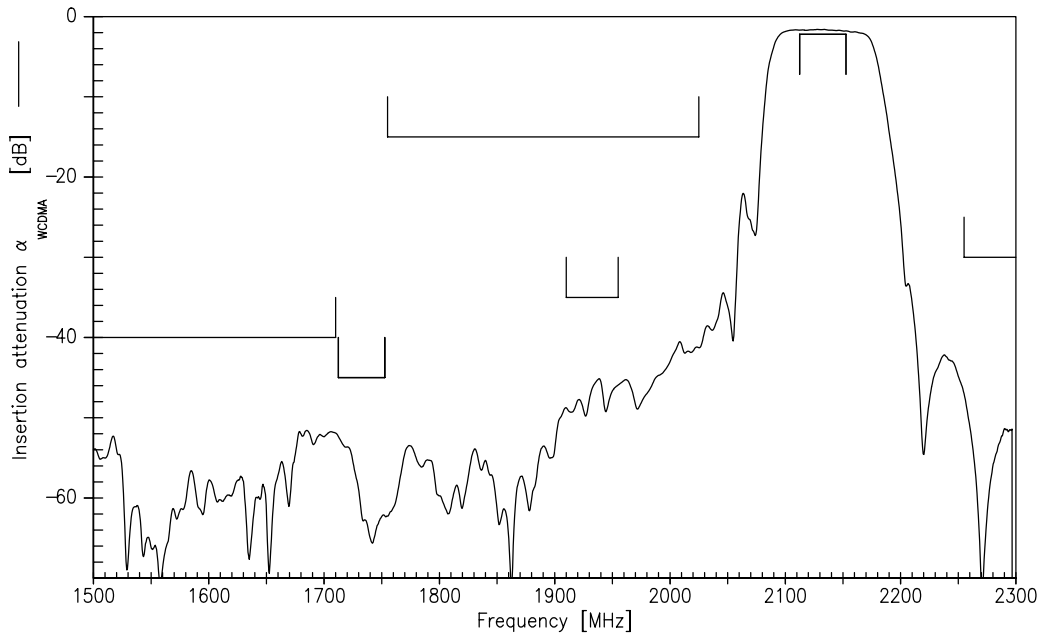

Power Transfer Function Ant-Rx (wideband):

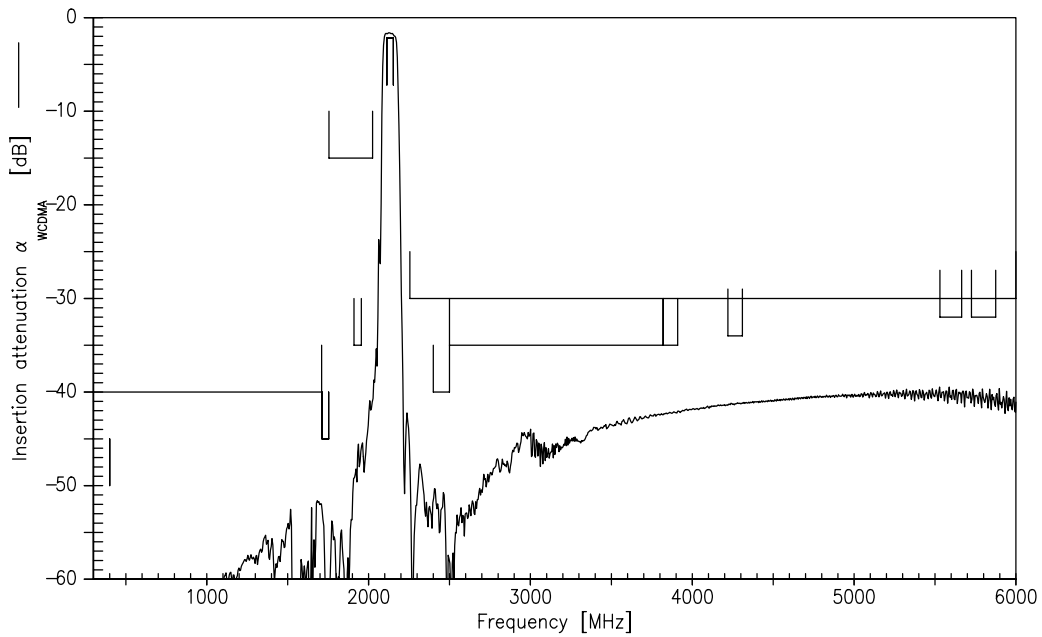

Please read *cautions and warnings* and *important notes* at the end of this document.



Power Transfer Function Tx-Rx isolation:

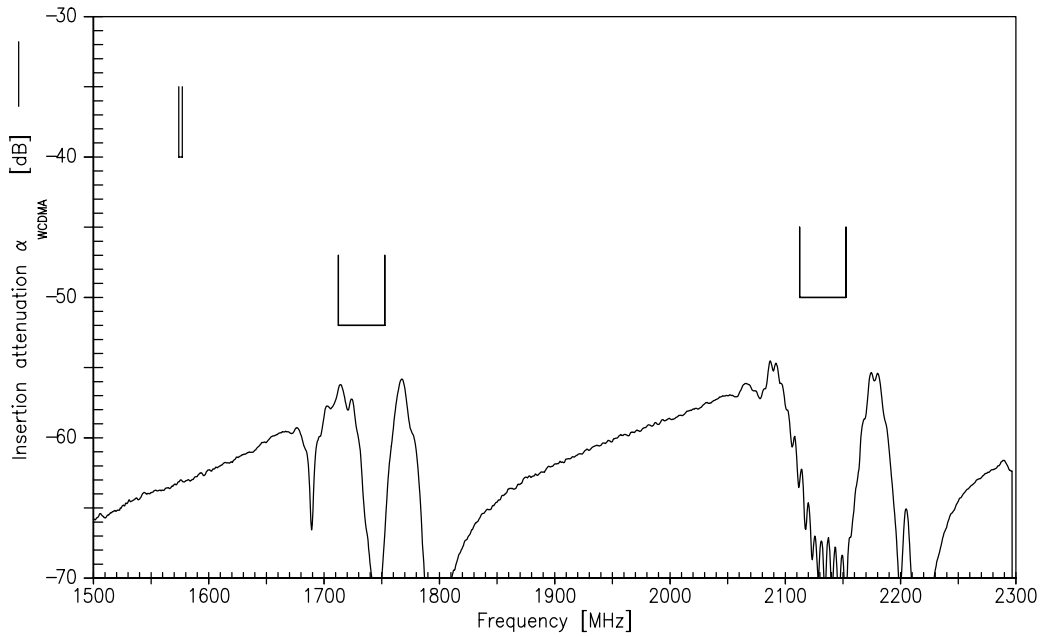

Power Transfer Function Tx-Rx isolation (wideband):

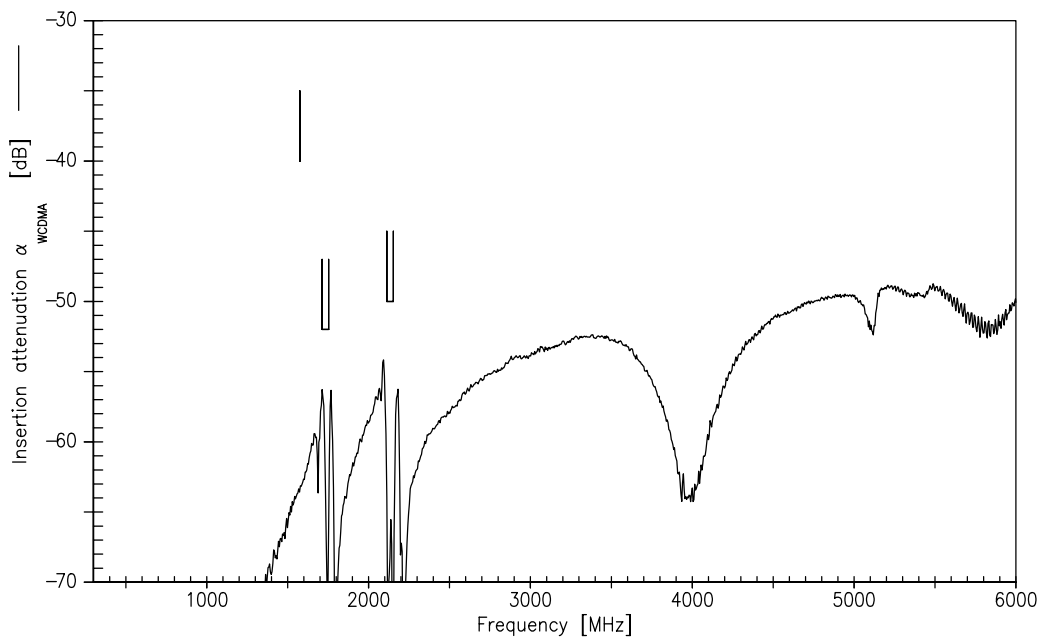

Please read *cautions and warnings and important notes* at the end of this document.



VSWRs at Tx, Rx and Ant:

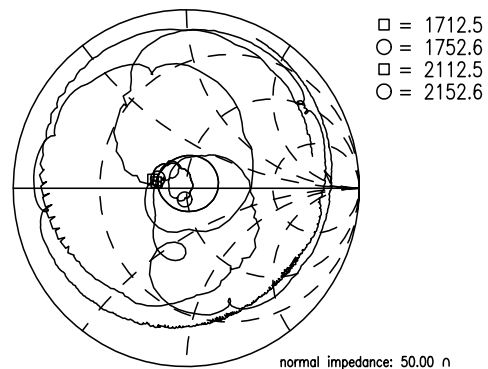
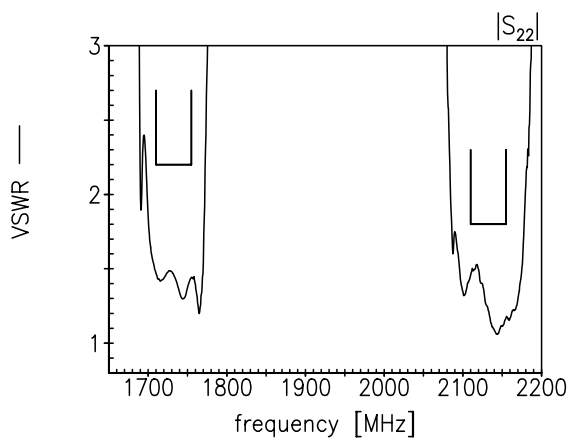
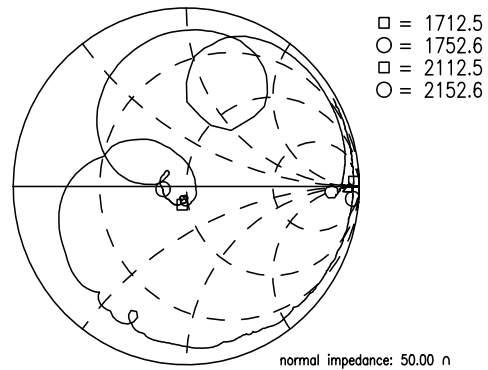
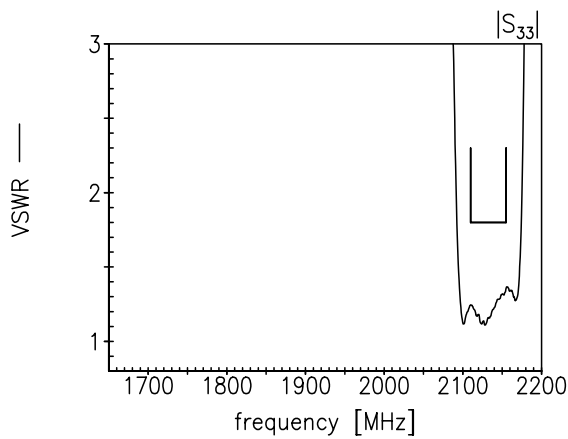
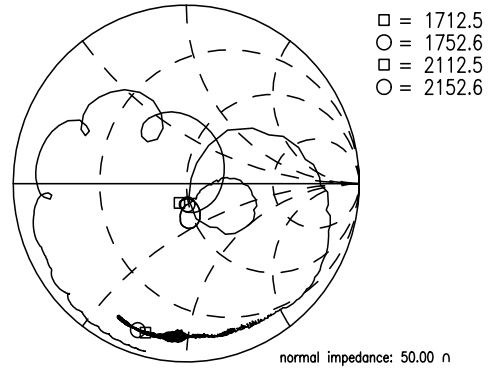
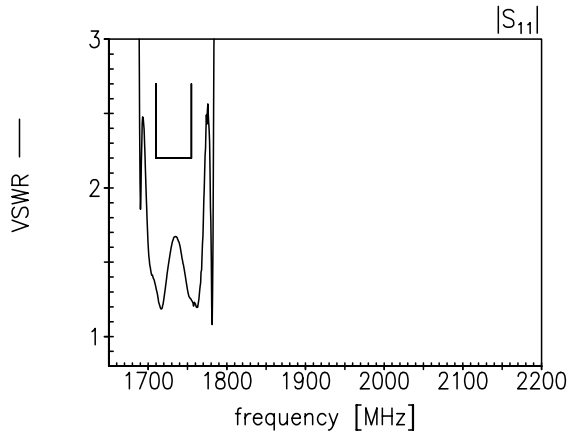

Please read *cautions and warnings* and *important notes* at the end of this document.

SAW Components
B8517
SAW Duplexer
1732.5 / 2132.5 MHz

Data Sheet



References

Type	B8517
Ordering code	B39212B8517P810
Marking and package	C61157-A8-A76
Packaging	F61074-V8247-Z000
Date codes	L_1126
S-parameters	B8517_NB_UN.s3p, B8517_WB_UN.s3p See file header for pin/port assignments
Soldering profile	S_6001
RoHS compatible	defined as compatible with the following documents: "DIRECTIVE 2002/95/EC OF THE EUROPEAN PARLIAMENT AND OF THE COUNCIL of 27 January 2003 on the restriction of the use of certain hazardous substances in electrical and electronic equipment. 2005/618/EC from April 18th, 2005, amending Directive 2002/95/EC of the European Parliament and of the Council for the purposes of establishing the maximum concentration values for certain hazardous substances in electrical and electronic equipment."
Matching coils	See Inductor pdf-catalog http://www.tdk.co.jp/tefe02/coil.htm#aname1 and Data Library for circuit simulation http://www.tdk.co.jp/etvcl/index.htm for a large variety of matching coils.

For further information please contact your local EPCOS sales office or visit our webpage at www.epcos.com.

Published by EPCOS AG
Systems, Acoustics, Waves Business Group
P.O. Box 80 17 09, 81617 Munich, GERMANY

© EPCOS AG 2013. This brochure replaces the previous edition.

For questions on technology, prices and delivery please contact the Sales Offices of EPCOS AG or the international Representatives.

Due to technical requirements components may contain dangerous substances. For information on the type in question please also contact one of our Sales Offices.

Please read *cautions and warnings and important notes* at the end of this document.

12 June 4, 2013

Important notes

The following applies to all products named in this publication:

1. Some parts of this publication contain **statements about the suitability of our products for certain areas of application**. These statements are based on our knowledge of typical requirements that are often placed on our products in the areas of application concerned. We nevertheless expressly point out **that such statements cannot be regarded as binding statements about the suitability of our products for a particular customer application**. As a rule, EPCOS is either unfamiliar with individual customer applications or less familiar with them than the customers themselves. For these reasons, it is always ultimately incumbent on the customer to check and decide whether an EPCOS product with the properties described in the product specification is suitable for use in a particular customer application.
2. We also point out that **in individual cases, a malfunction of electronic components or failure before the end of their usual service life cannot be completely ruled out in the current state of the art, even if they are operated as specified**. In customer applications requiring a very high level of operational safety and especially in customer applications in which the malfunction or failure of an electronic component could endanger human life or health (e.g. in accident prevention or life-saving systems), it must therefore be ensured by means of suitable design of the customer application or other action taken by the customer (e.g. installation of protective circuitry or redundancy) that no injury or damage is sustained by third parties in the event of malfunction or failure of an electronic component.
3. **The warnings, cautions and product-specific notes must be observed.**
4. In order to satisfy certain technical requirements, **some of the products described in this publication may contain substances subject to restrictions in certain jurisdictions (e.g. because they are classed as hazardous)**. Useful information on this will be found in our Material Data Sheets on the Internet (www.epcos.com/material). Should you have any more detailed questions, please contact our sales offices.
5. We constantly strive to improve our products. Consequently, **the products described in this publication may change from time to time**. The same is true of the corresponding product specifications. Please check therefore to what extent product descriptions and specifications contained in this publication are still applicable before or when you place an order. We also **reserve the right to discontinue production and delivery of products**. Consequently, we cannot guarantee that all products named in this publication will always be available. The aforementioned does not apply in the case of individual agreements deviating from the foregoing for customer-specific products.
6. Unless otherwise agreed in individual contracts, **all orders are subject to the current version of the "General Terms of Delivery for Products and Services in the Electrical Industry" published by the German Electrical and Electronics Industry Association (ZVEI)**.
7. The trade names EPCOS, BAOKE, Alu-X, CeraDiode, CeraLink, CSMP, CSSP, CTVS, DeltaCap, DigiSiMic, DSSP, FilterCap, FormFit, MiniBlue, MiniCell, MKD, MKK, MLSC, MotorCap, PCC, PhaseCap, PhaseCube, PhaseMod, PhiCap, SIFERRIT, SIFI, SIKOREL, SilverCap, SIMDAD, SiMic, SIMID, SineFormer, SIOV, SIP5D, SIP5K, ThermoFuse, WindCap are **trademarks registered or pending** in Europe and in other countries. Further information will be found on the Internet at www.epcos.com/trademarks.

单击下面可查看定价，库存，交付和生命周期等信息

[>>Qualcomm-RF360](#)