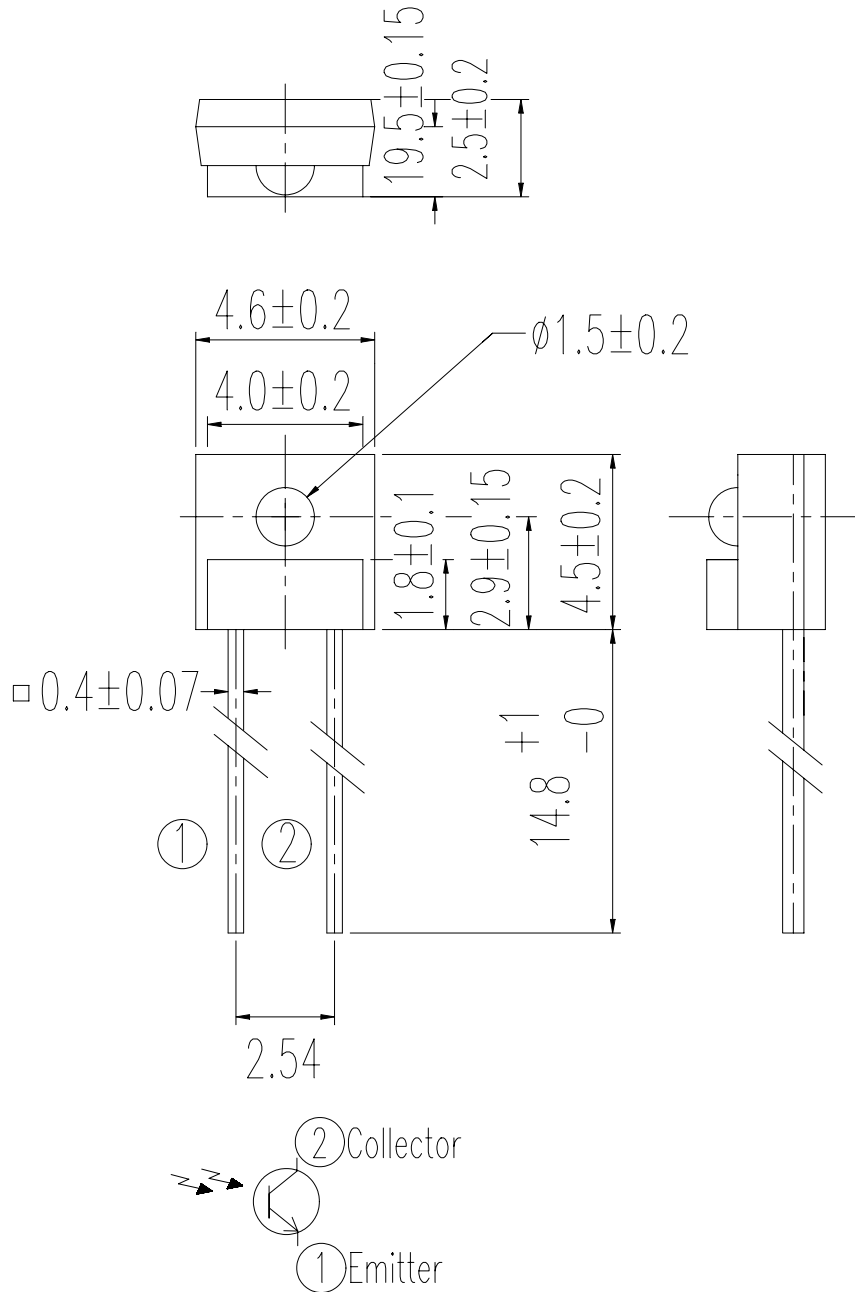

Package Dimensions:

DESIGNER	CHECKER	APPROVED

Office: NO 25, Lane 76, Chung Yang Rd., Sec.3

Tucheng, Taipei 236, Taiwan, R.O.C.

TEL: 886-2-2267-2000, 2267-9936 (22 Lines)

FAX: 886-2-2267-6189

©Notes :

1. All dimensions are in millimeter.
2. Lead spacing is measured where the lead emerge from the package .
3. Above specification may be changed without notice. EVERLIGHT will reserve authority on material change for above specification.
4. These specification sheets include materials protected under copyright of EVERLIGHT corporation . Please don't reproduce or cause anyone to reproduce them without EVERLIGHT's consent.
5. When using this product , please observe the absolute maximum ratings and the instructions for use outlined in these specification sheets. EVERLIGHT assumes no responsibility for any damage resulting from use of the product which does not comply with the absolute maximum ratings and the instructions included in these specification sheets.

Description

The **PT928-6B** is a high speed and high sensitivity single photo transistor; molded in a black plastic package with spherical side view lens.

The device is spectrally matched with IR emitters.

Features

- Wide angle of half sensitivity $\theta = \pm 25^\circ$
- High sensitivity
- Fast response time
- Pb free
- The product itself will remain within RoHS compliant version.

Applications

- Mouse
- Optoelectronic Switch
- Photo Interrupter

Absolute Maximum Ratings

(Ta=25°C)

ITEM	SYMBOL	RATING	UNIT
Collector Power Dissipation	Pc	75	mW
Collector-Emitter Voltage	V _{CEO}	30	V
Emitter-Collector Voltage	V _{ECO}	5	V
Collector Current	Ic	20	mA
Operating Temperature	Topr	-25~+85	°C
Storage Temperature	Tstg	-40~+85	°C
Soldering Temperature (1/16 inch from body for 5 seconds)	Tsol	260	°C

Electro-Optical Characteristics

(Ta=25°C)

Parameter		Symbol	Min	Typ	Max	Unit	Condition
Collector Dark Current		I _{CEO}	-	-	100	nA	V _{CE} =20V, Ee=0mW/cm ²
C-E Saturation Voltage		V _{CE(Sat)}	-	-	0.4	V	Ic=0.5mA, Ee=10mW/cm ²
Light Current		I _L	0.6	-	4.0	mA	V _{CE} =5V, I _F =5mA
The Wavelength of Peak Sensitivity		λ _p	-	860	-	nm	---
Range of Spectral Bandwidth		λ _{0.5}		700...1200	-	nm	---
Response Time	Rise Time	t _r	-	15	-	μ Sec	V _{CE} =5V Ic=1mA R _L =1000Ω
	Fall Time	t _f	-	15	-	μ Sec	
Half sensitivity angle		Δθ	-	±25	-	°	---

Typical Characteristics

Fig.1 Collector Power Dissipation vs. Ambient Temperature

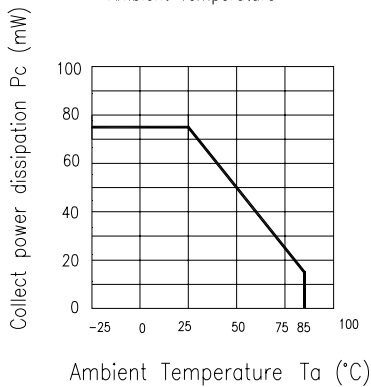

Fig.2 Collector Dark Current vs. Ambient Temperature

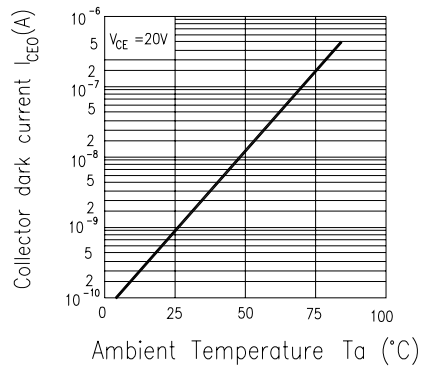

Fig. 3 Relative Collector Current vs. Ambient Temperature

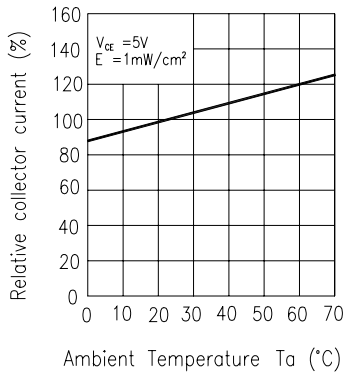

Fig.4 Collector Current vs. Irradiance

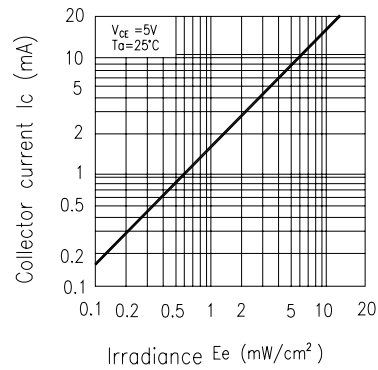

Fig.5 Spectral Sensitivity

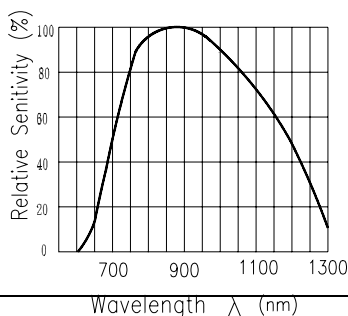
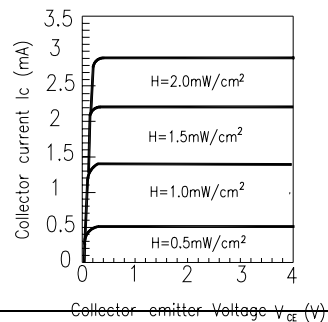
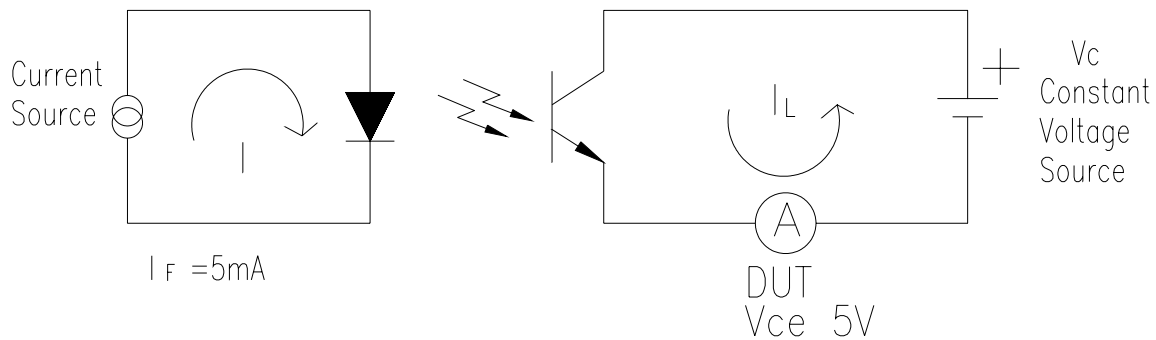

Fig.6 Collector Current vs. Collector-emitter Voltage



Test Method

The light current testing method for PTR:

**Rankings**

Parameter	Symbol	Min	Max	Unit	Test Condition
6-1	I_L	2.0	4.0	mA	$V_{CE}=5V$ $I_F=5mA$
6-2		1.8	3.5		
7-1		1.4	2.6		
7-2		1.0	2.0		
7-3		0.6	1.4		

Supplements

1.Parts

(1) Chip

Type	Material	Peak Wavelength
PT	Silicon	860nm

(2) Material

Type	Lead frame	Wire	Package
Material	SPCC	Gold	Epoxy

Reliability

The reliability of products shall be satisfied with items listed below.

Confidence level : 90%

LTPD : 10%

Test Items	Test Conditions	Failure Judgement Criteria	Samples(n)
			<u>Defective(c)</u>
Operating life test	$V_{CE}=5V$ $T_a : 25^{\circ}C$ 1000hrs	$I_L \leq L \times 0.8$ $L : \text{Lower specification limit}$	n =22 , c=0
Temperature cycle	1cycle $-55^{\circ}C$ to $+25^{\circ}C$ to $+85^{\circ}C$ (30min) (5min) (30min) 50 cycle test		n =22 , c=0
Thermal shock	$-55^{\circ}C$ to $+85^{\circ}C$ (5min) (5min) 50cycle test		n =22 , c=0
High temperature storage	Temp : $+100^{\circ}C$ 1000hrs		n =22 , c=0
Low temperature storage	Temp : $-55^{\circ}C$ 1000hrs		n =22 , c=0
High temperature High humidity	$T_a : 85^{\circ}C$ RH : 85% 1000hrs		n =22 , c=0
Solder heat	Temp : $260 \pm 5^{\circ}C$ 10 sec		n =22 , c=0
Solderability	Temp : $230 \pm 5^{\circ}C$ 3 sec		n =22 , c=0

Packing Specifications

1. Bag

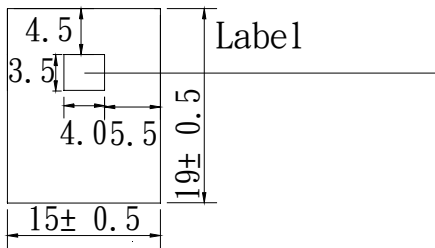

2. Box

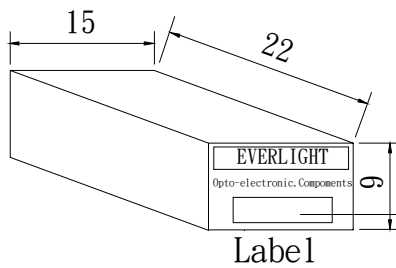

3. Carton

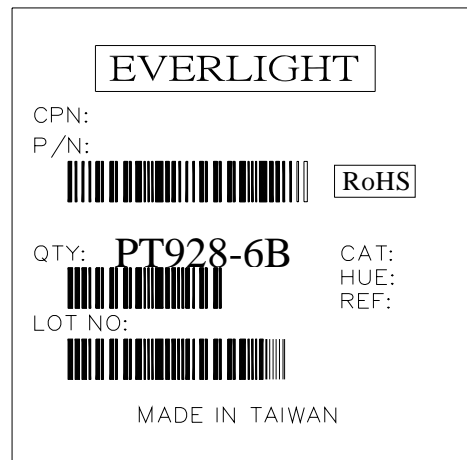
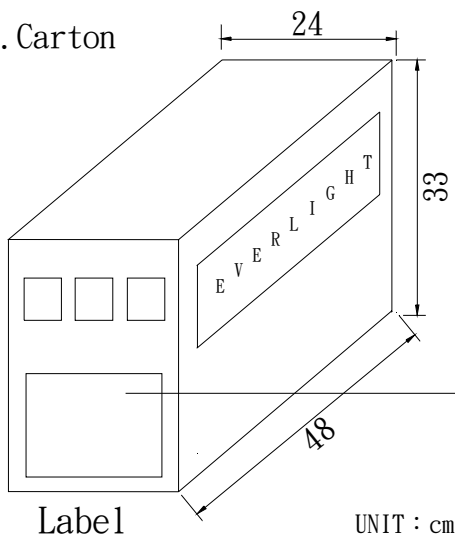
**CPN: Customer's product number****P/N: Product number****QTY: Packing quantity****CAT: Ranks****HUE: Peak wavelength****REF: Reference****LOT NO: Lot number****MADE IN TAIWAN: Production place****Packing Quantity Specification**

1.1000Pcs/1bag , 10bags/1box

2.10boxes/1Carton

单击下面可查看定价，库存，交付和生命周期等信息

[>>Everlight\(亿光\)](#)