

825 Series Full Color
STF0A36ZA-B (SFT825B-S)

Product Brief

Description

- This White Colored surface-mount LED comes in standard package dimension. Package Size: 3.5x2.8x0.75mm
- The package design coupled with careful selection of component materials allow these products to perform with high reliability in a larger temperature range -40°C to 110°C.
- The high reliability feature is crucial to Automotive interior and Indoor ESS.

Features and Benefits

- R,G,B Full Color
- ESD min 2kV
- MSL 2a Level
- Viewing angle 120°
- RoHS compliant

Key Applications

- Automotive Lighting

Table of Contents

Index	
• Product Brief	1
• Table of Contents	2
• Performance Characteristics	3
• Characteristics Graph	5
• Color Bin Structure	22
• Mechanical Dimensions	24
• Recommended Solder Pad	23
• Reflow Soldering Characteristics	25
• Emitter Tape & Reel Packaging	26
• Product Nomenclature	28
• Handling of Silicone Resin for LEDs	29
• Precaution For Use	30
• Company Information	32

Performance Characteristics

Table 1. Electro Optical Characteristics, $I_F = 20\text{mA}$, $T_S = 25^\circ\text{C}$

Parameter	Symbol	Value			Unit	
		Min.	Typ.	Max.		
Forward Current	R.G.B	I_F	5	20	50	mA
Forward Voltage ^[1]	Red	V_F	1.8	2.1	2.4	V
	Green	V_F	2.8	3.0	3.4	
	Blue	V_F	2.8	3.1	3.4	
Luminance Intensity ^[1]	Red	I_V	560	710	900	mcd
	Green	I_V	1400	1800	2300	
	Blue	I_V	315	410	620	
Luminance Flux ^[3]	Red	Φ_V	-	2380	-	mlm
	Green	Φ_V	-	6200	-	
	Blue	Φ_V	-	1580	-	
Dominant Wavelength ^[1]	Red	λ_d	623	626	632	-
	Green	λ_d	520	526	532	
	Blue	λ_d	462	465	471	
Viewing Angle ^[2]	R.G.B	$2\theta_{1/2}$		120		deg.
Thermal resistance (J to A)	Red	$R\theta_{J-A}$ (ELEC.)	-	152		K/W
	Green		-	210		
	Blue		-	165		
Thermal resistance (J to S)	Red	$R\theta_{J-S}$ (ELEC.)	-	60		K/W
	Green		-	160		
	Blue		-	90		

Notes :

- (1) Tolerance : $V_F : \pm 0.1\text{V}$, $I_V : \pm 10\%$, $\lambda_d : \pm 0.5\text{nm}$
- (2) $\theta_{1/2}$ is the off-axis where the luminous intensity is 1/2 of the peak intensity.
- (3) Φ_V is the total luminous flux output as measured with an integrating sphere.

* No values are provided by real measurement. Only for reference purpose.

Performance Characteristics

Table 2. Absolute Maximum Ratings

Parameter	Symbol	Value			Unit
		Red	Green	Blue	
Power Dissipation ($T_a=25^{\circ}\text{C}$)	P_d	0.12 ^[1]	0.17 ^[1]	0.17 ^[1]	W
Forward Current ($T_a=25^{\circ}\text{C}$)	I_F	50	50	50	mA
Peak Forward Current ($t_p \leq 10\mu\text{sec}$, $D=0.005$, $T_a=25^{\circ}\text{C}$)	I_{FM}	200	250	250	mA
Operating Temperature	T_{opr}	-40 ~ +110			$^{\circ}\text{C}$
Storage Temperature	T_{stg}	-40 ~ +110			$^{\circ}\text{C}$
Junction Temperature	T_j	125			$^{\circ}\text{C}$
Soldering Temperature	T_{sld}	Reflow Soldering : 260 $^{\circ}\text{C}$ for 10sec. Hand Soldering : 315 $^{\circ}\text{C}$ for 4sec.			
ESD ^[2]	-	ESD Class H3A (JESD22-A114-E)			

Notes :

- (1) The value for one LED device. (Single color)
- (2) A ESD Protection device is included for protection.

- LED's properties might be different from suggested values like above and below tables if operation condition will be exceeded our parameter range. Care is to be taken that power dissipation does not exceed the absolute maximum rating of the product.
- All measurements were made under the standardized environment of Seoul Semiconductor.

Characteristics Graph

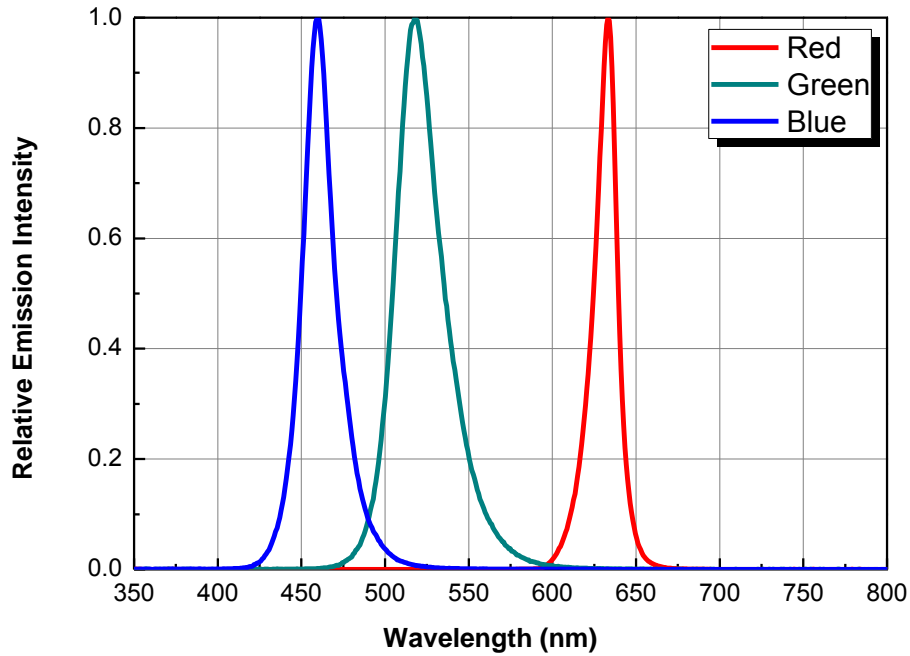
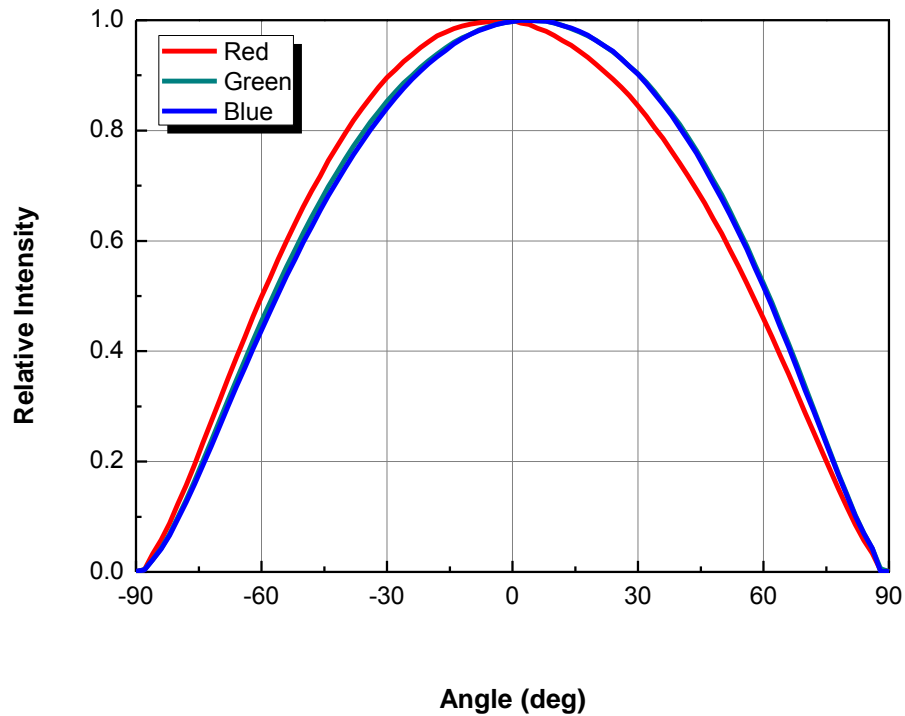
Fig 1. Color Spectrum, $T_s=25^\circ\text{C}$, $I_F=20\text{mA}$

Fig 2.1. Radiant pattern, $I_F=20\text{mA}$ (horizontal)

Characteristics Graph

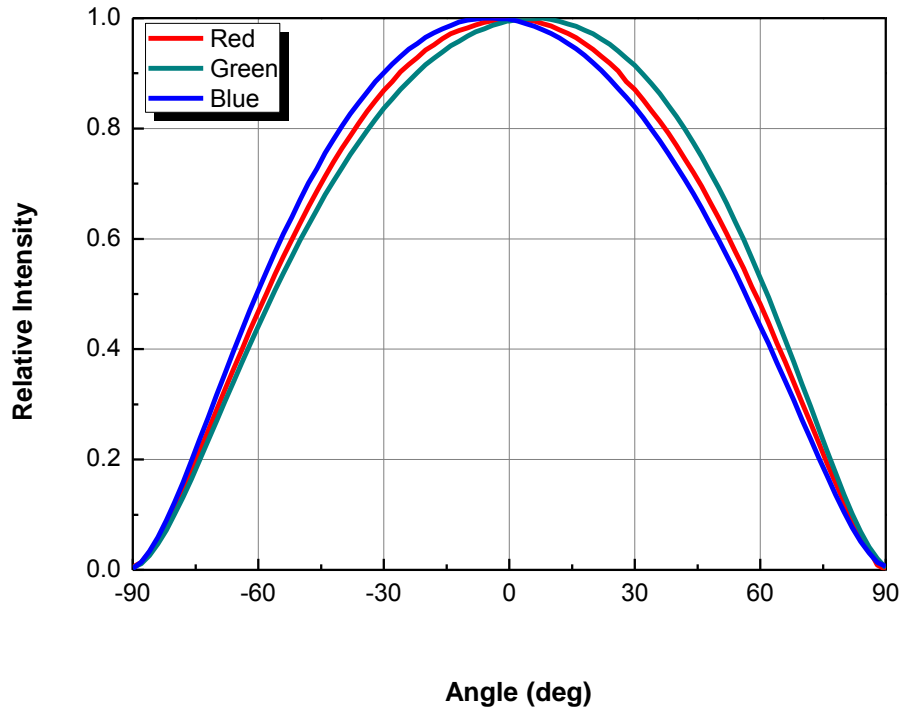
Fig 2.2.Radiant pattern, $I_F=20\text{mA}$ (Vertical)

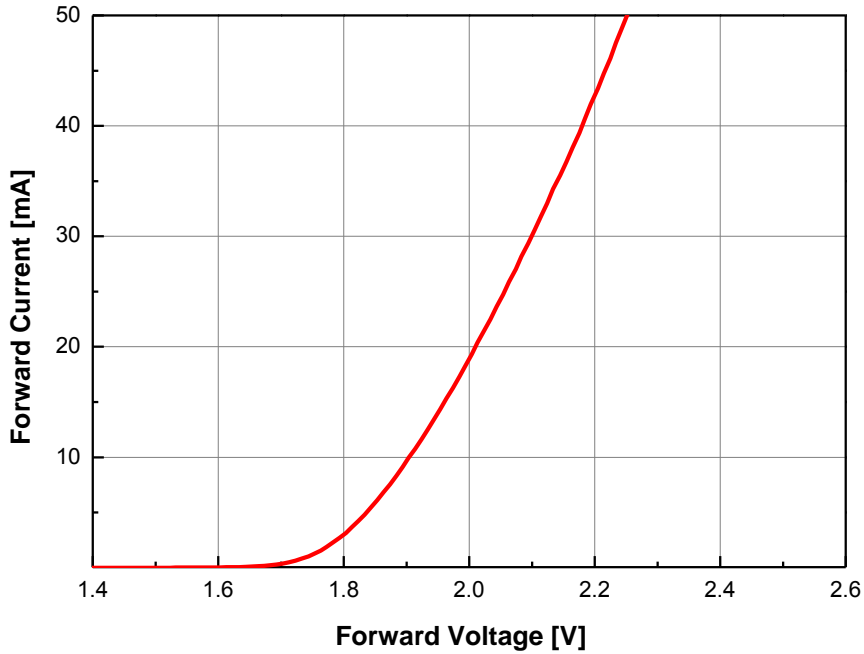
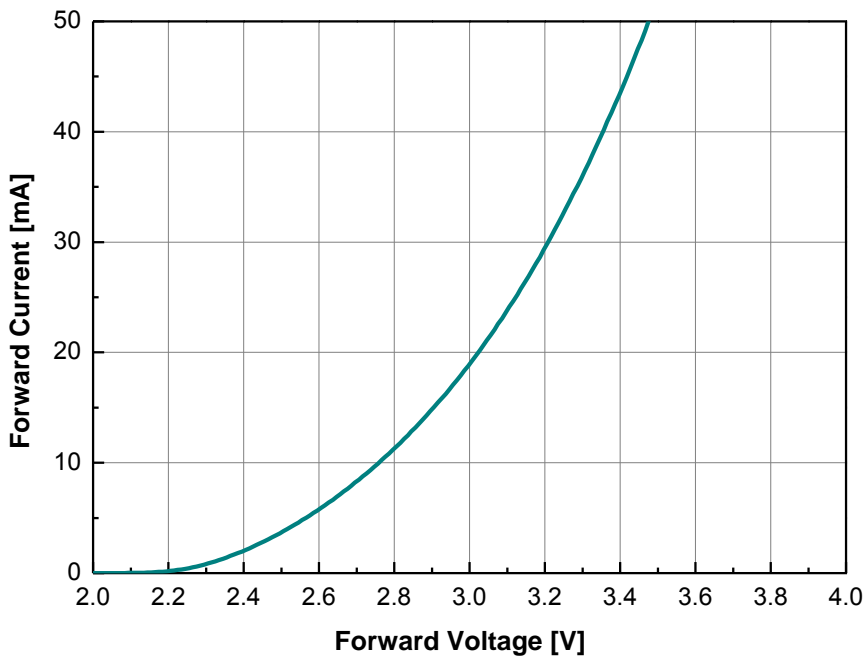

Characteristics Graph

Fig 3.1. Forward Voltage vs. Forward Current, $T_j=25^\circ\text{C}$ (Red)

Fig 3.2. Forward Voltage vs. Forward Current, $T_j=25^\circ\text{C}$ (Green)

Characteristics Graph

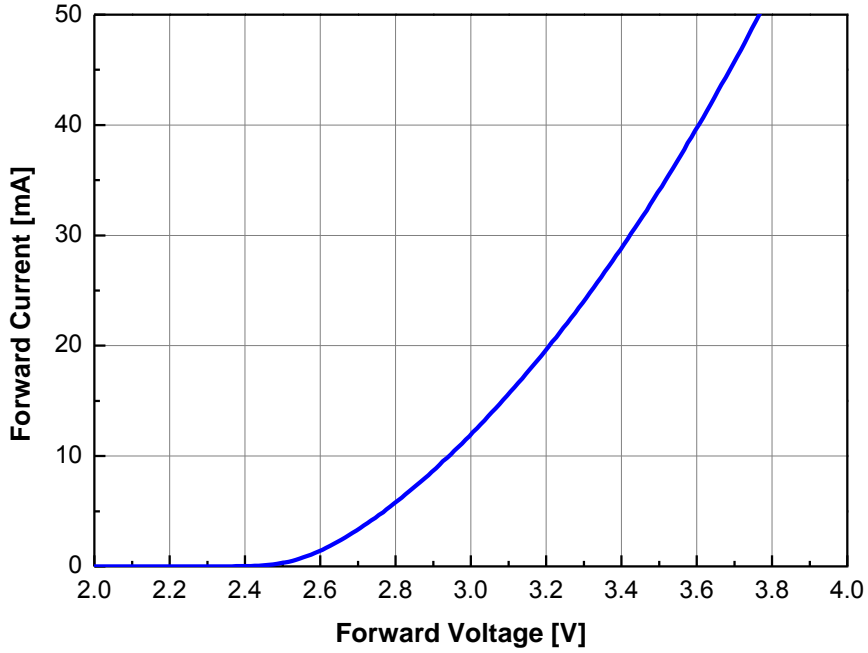
Fig 3.3 Forward Voltage vs. Forward Current, $T_j=25^{\circ}\text{C}$ (Blue)

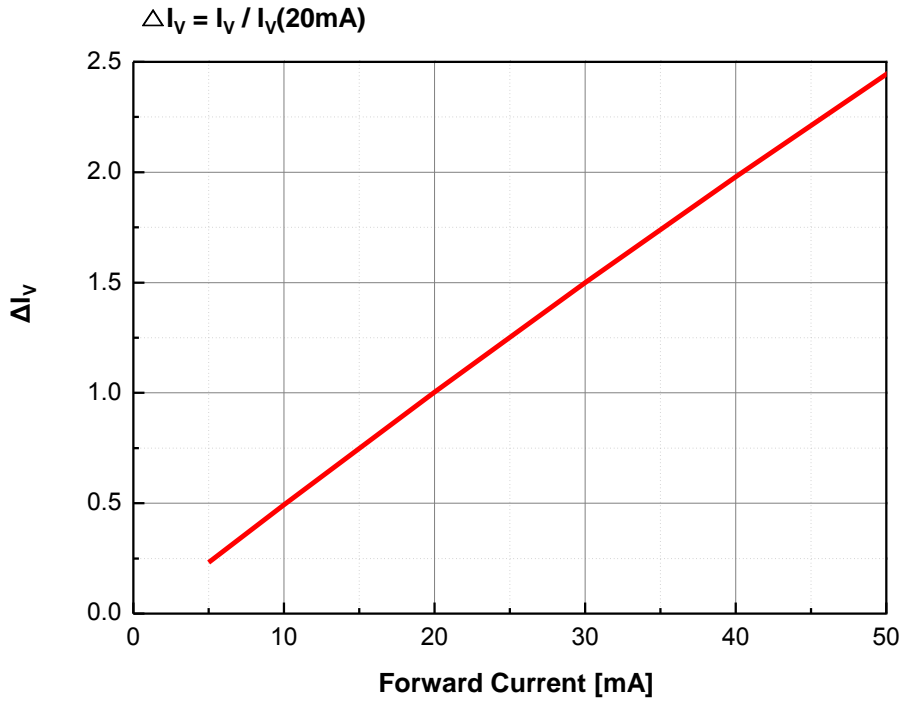
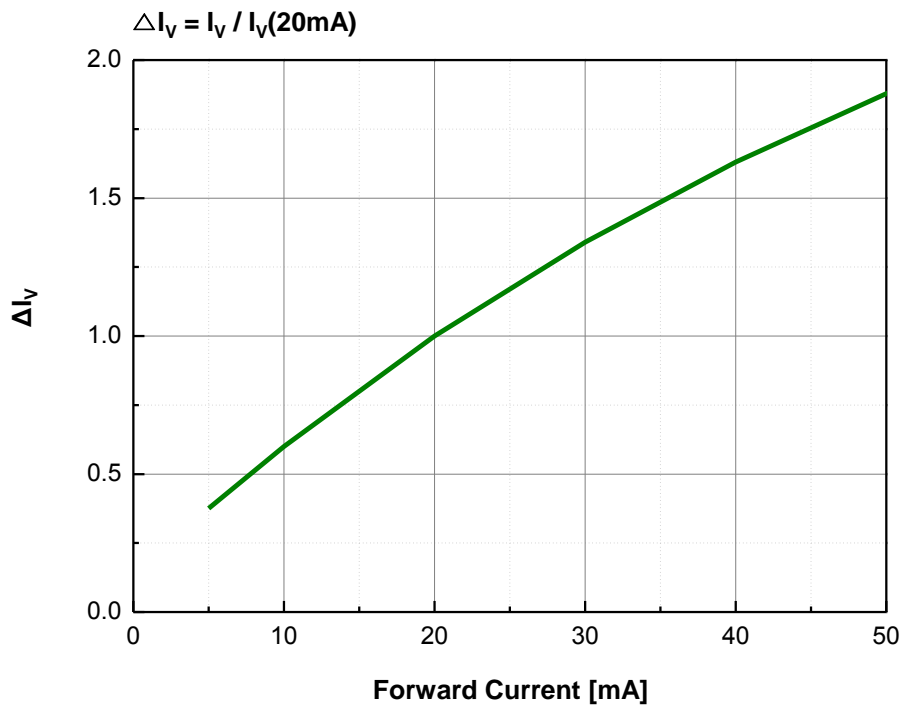

Characteristics Graph

Fig 4.1. Forward Current vs. Relative Luminous Flux, $T_j=25^\circ\text{C}$ (Red)

Fig 4.2. Forward Current vs. Relative Luminous Flux, $T_j=25^\circ\text{C}$ (Green)

Characteristics Graph

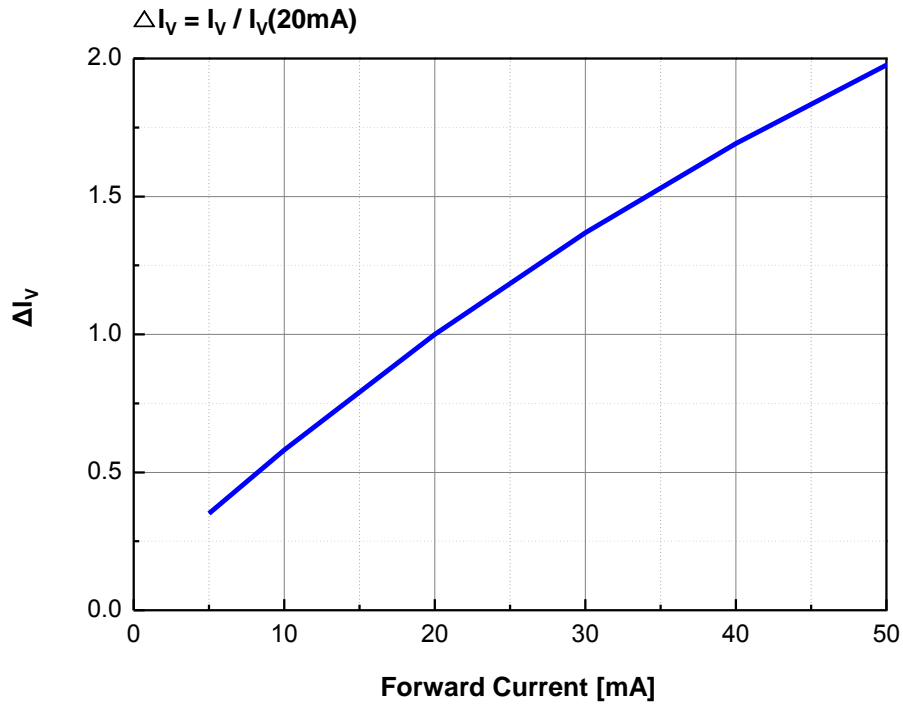
Fig 4.3. Forward Current vs. Relative Luminous Flux, $T_j=25^\circ\text{C}$ (Blue)

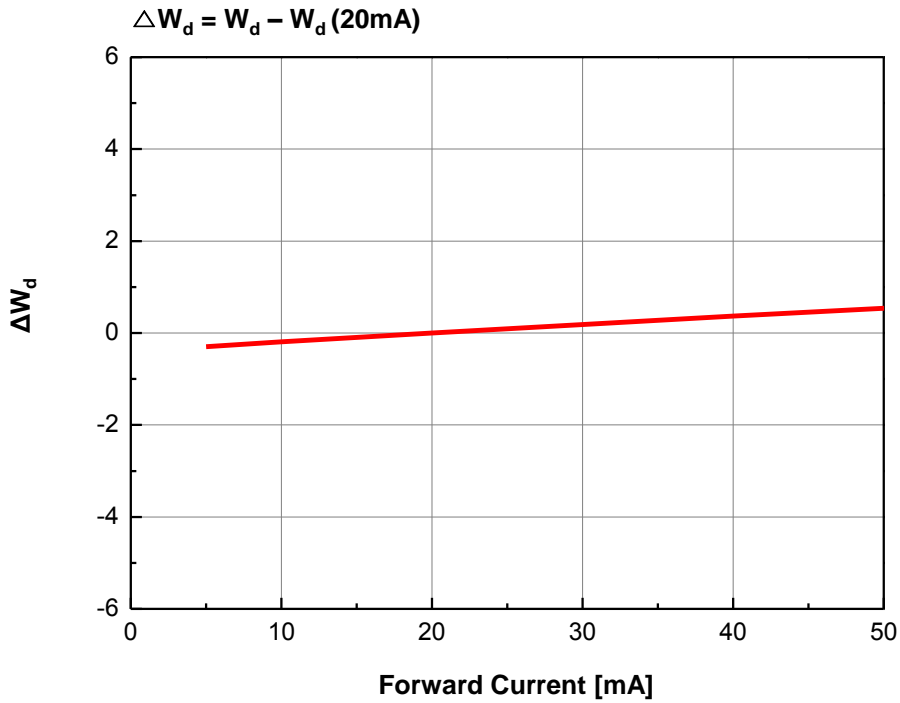
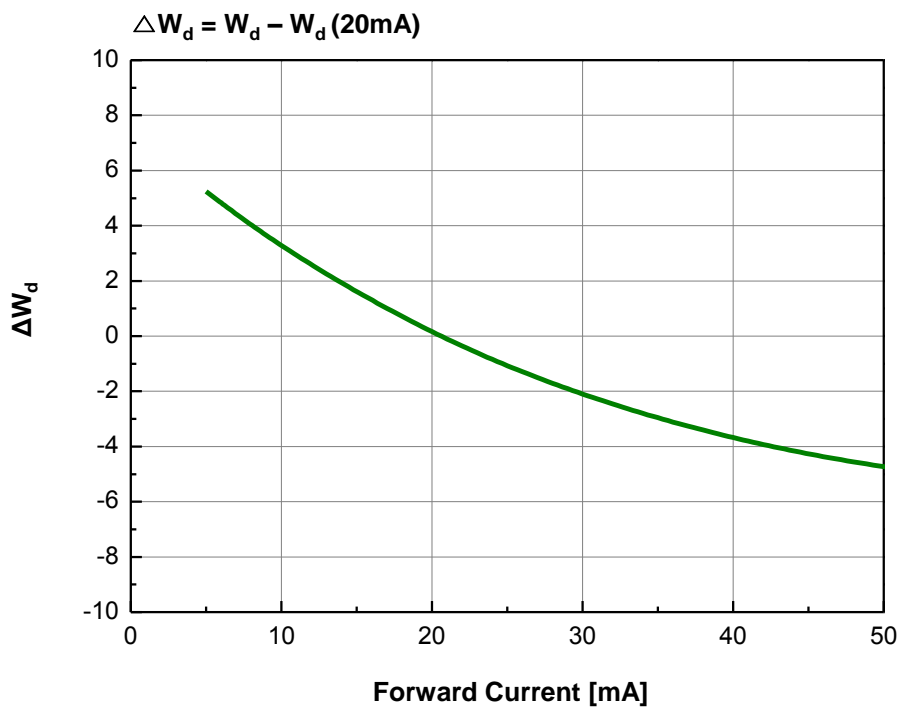

Characteristics Graph

Fig 5.1. Forward Current vs. Dominant Wavelength Shift, $T_j=25^\circ\text{C}$ (Red)

Fig 5.2. Forward Current vs. Dominant Wavelength Shift, $T_j=25^\circ\text{C}$ (Green)

Characteristics Graph

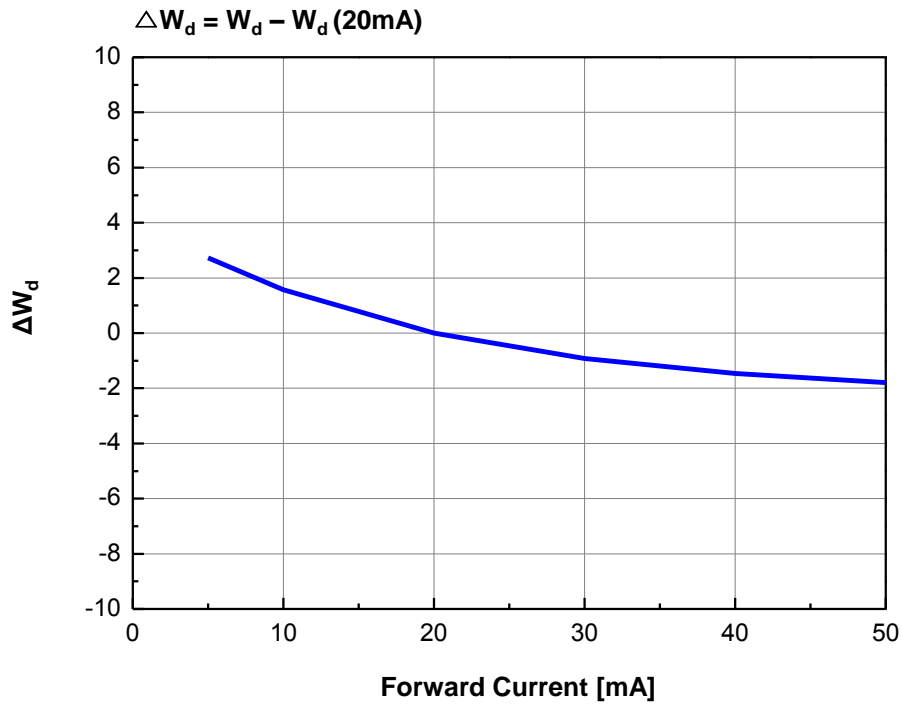
Fig 5.3. Forward Current vs. Dominant Wavelength Shift, $T_j=25^\circ\text{C}$ (Blue)

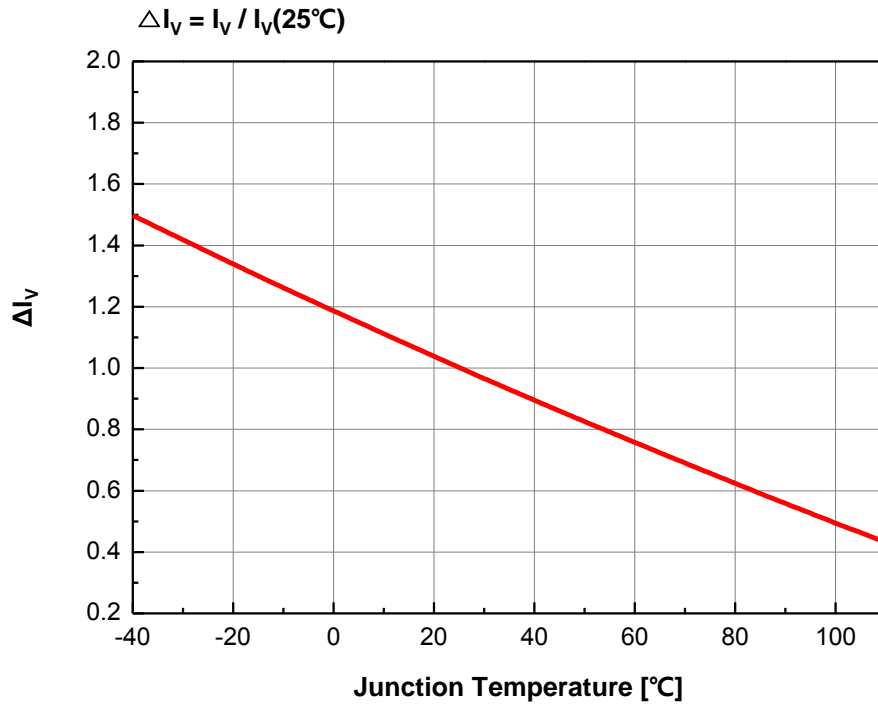
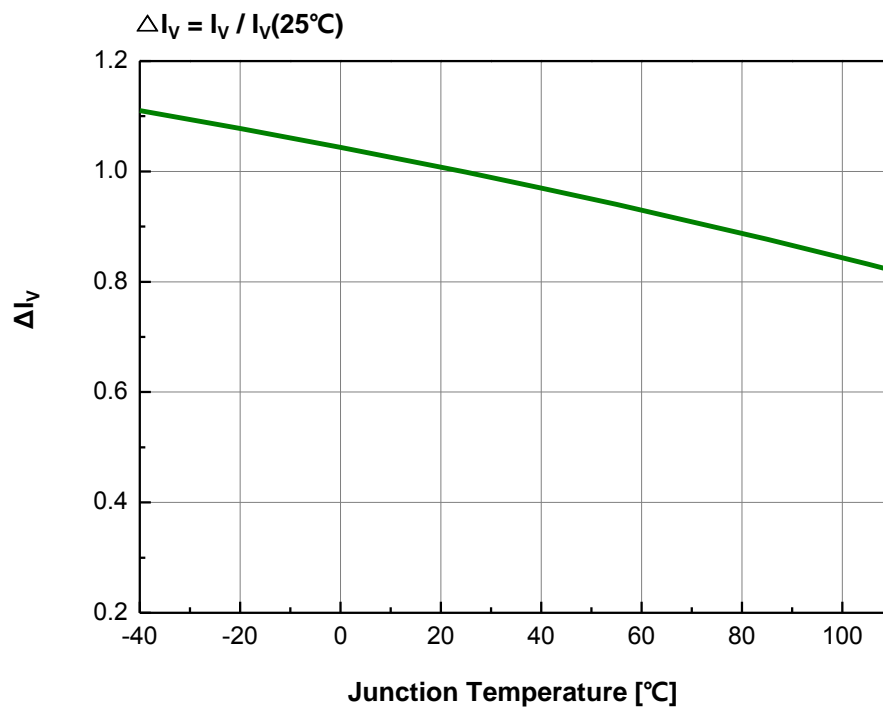

Characteristics Graph

Fig 6.1. Junction Temperature vs. Relative Light Output, $I_F=20\text{mA}$ (Red)

Fig 6.2. Junction Temperature vs. Relative Light Output, $I_F=20\text{mA}$ (Green)

Characteristics Graph

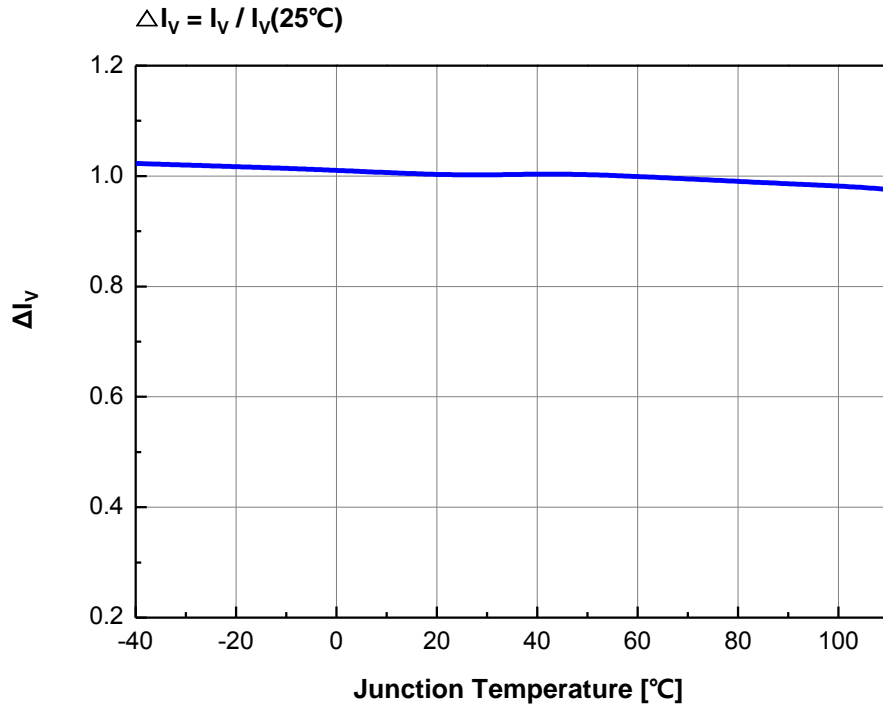
Fig 6.3. Junction Temperature vs. Relative Light Output, $I_F=20\text{mA}$ (Blue)



Characteristics Graph

Fig 7.1. Junction Temperature vs. Forward Voltage, $I_F=20\text{mA}$ (Red)

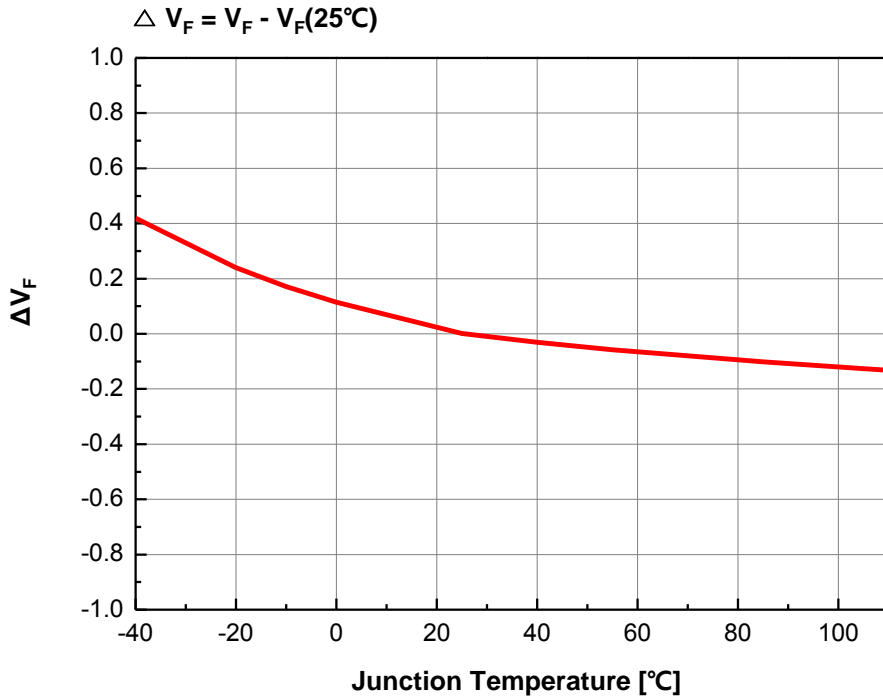
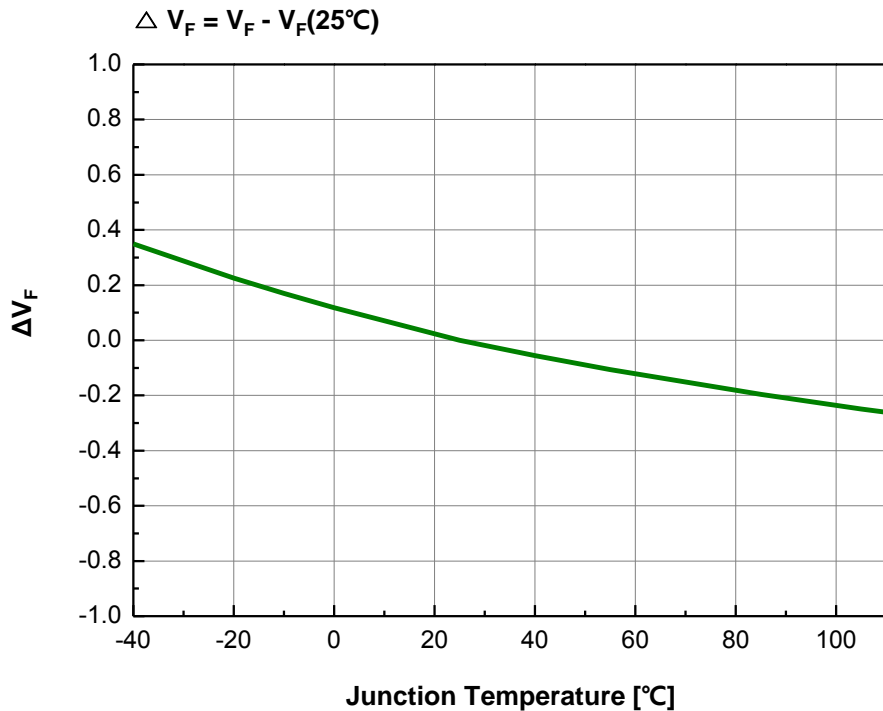
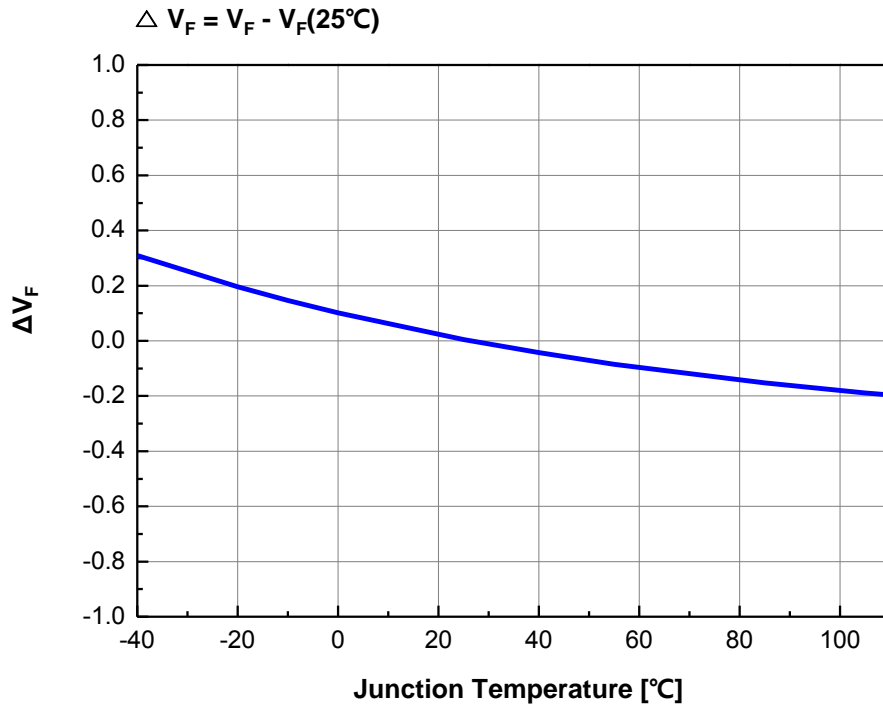

Fig 7.2. Junction Temperature vs. Forward Voltage, $I_F=20\text{mA}$ (Green)



Characteristics Graph

Fig 7.3. Junction Temperature vs. Forward Voltage, $I_F=20\text{mA}$ (Blue)

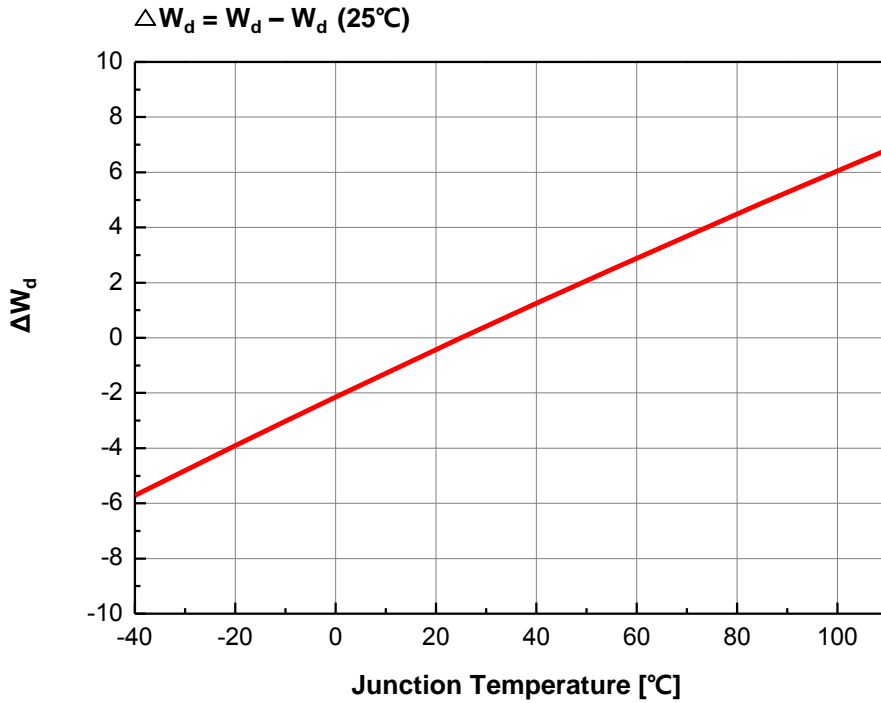
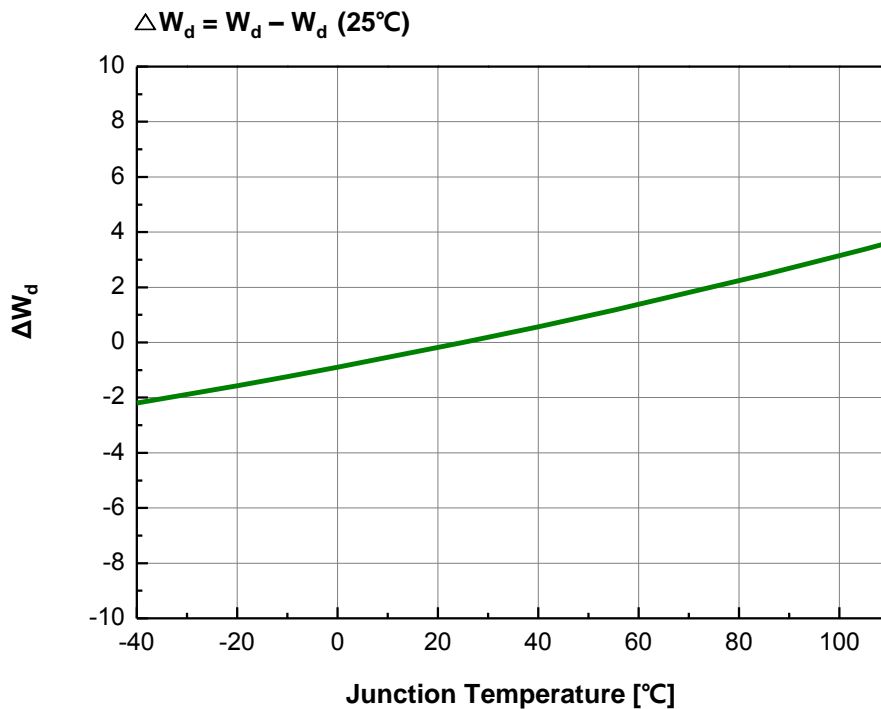

Characteristics Graph

Fig 8.1. Junction Temperature vs. Dominant Wavelength Shift, $I_F=20\text{mA}$ (Red)

Fig 8.2. Junction Temperature vs. Dominant Wavelength Shift, $I_F=20\text{mA}$ (Green)

Characteristics Graph

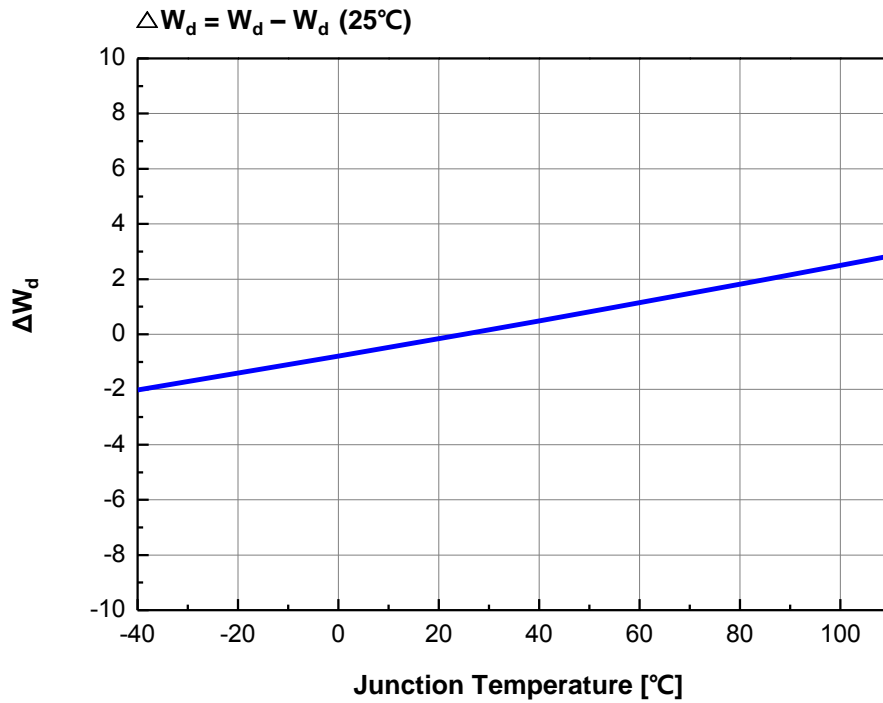
Fig 8.3. Junction Temperature vs. Dominant Wavelength Shift, $I_F=20\text{mA}$ (Blue)



Characteristics Graph

Fig 9.1. Maximum Forward Current vs. Temperature, 1 chip on (Red)

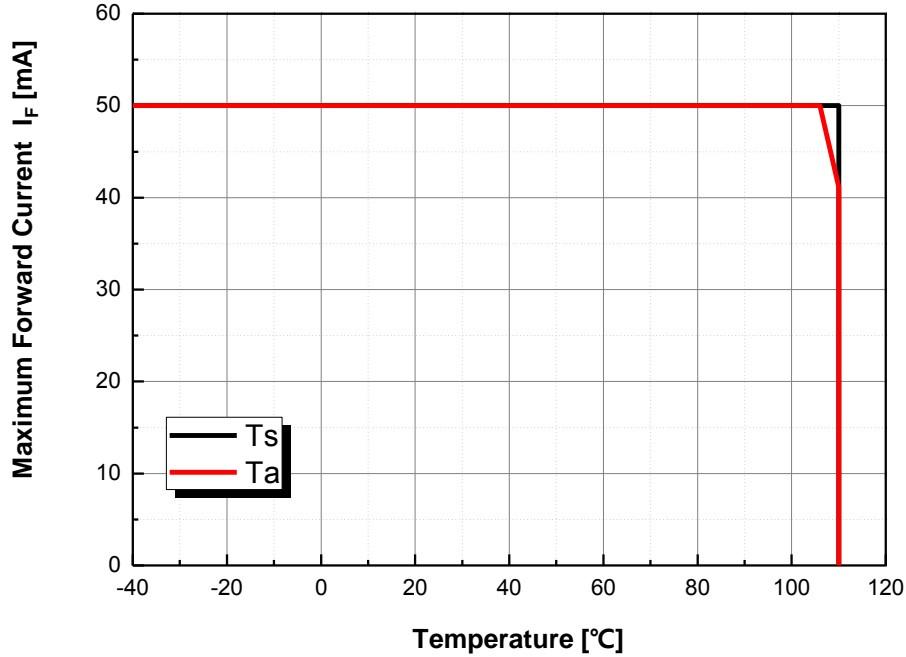
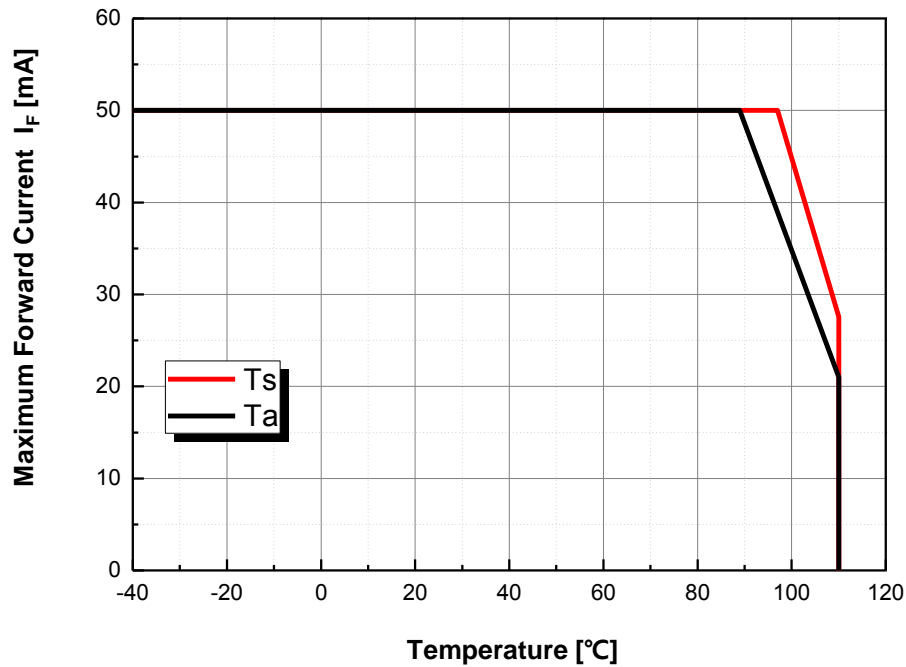

Fig 9.2. Maximum Forward Current vs. Temperature, 1 chip on (Green)



Characteristics Graph

Fig 9.3. Maximum Forward Current vs. Temperature, 1 chip on (Blue)

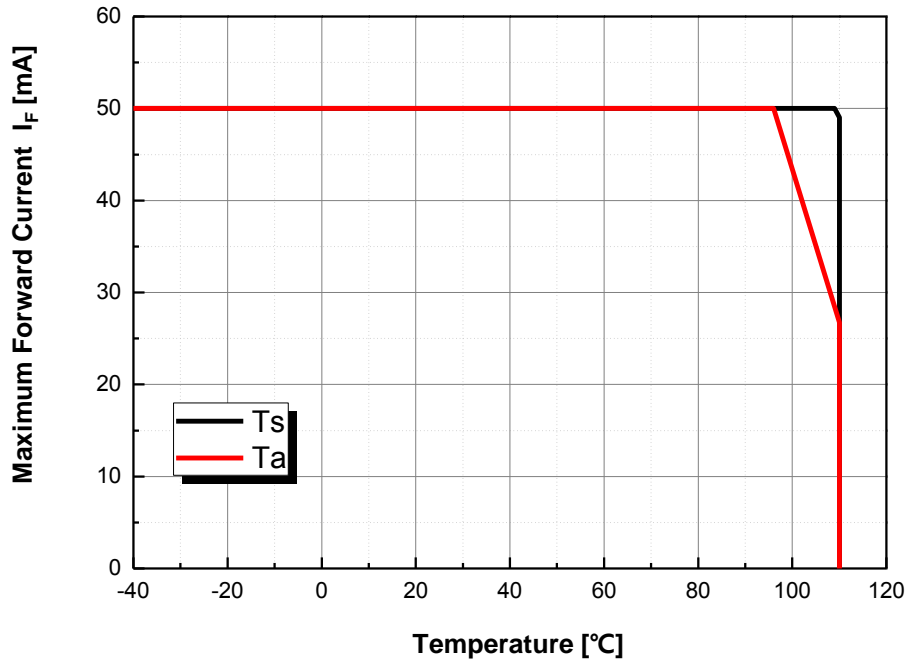
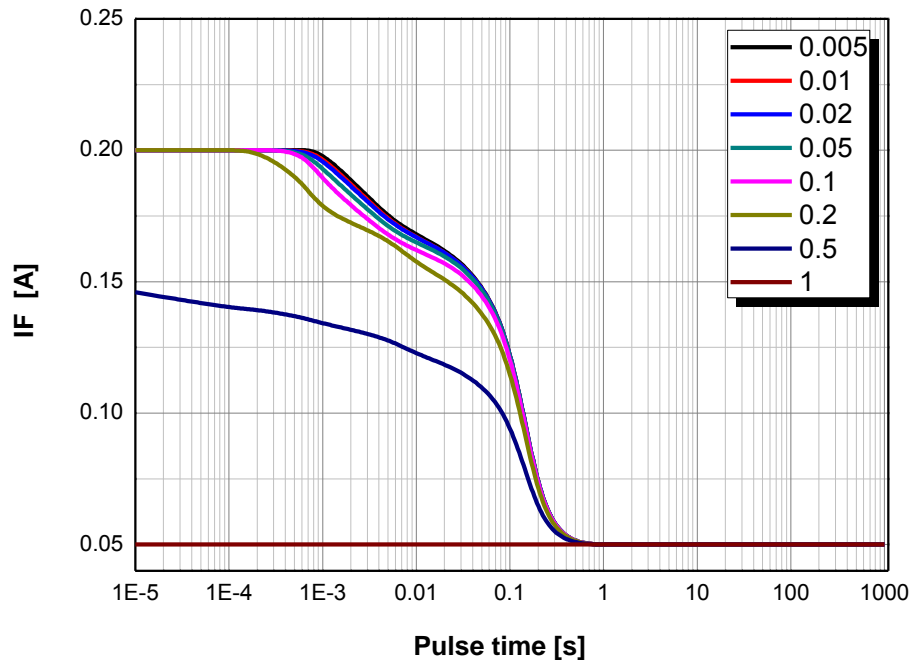
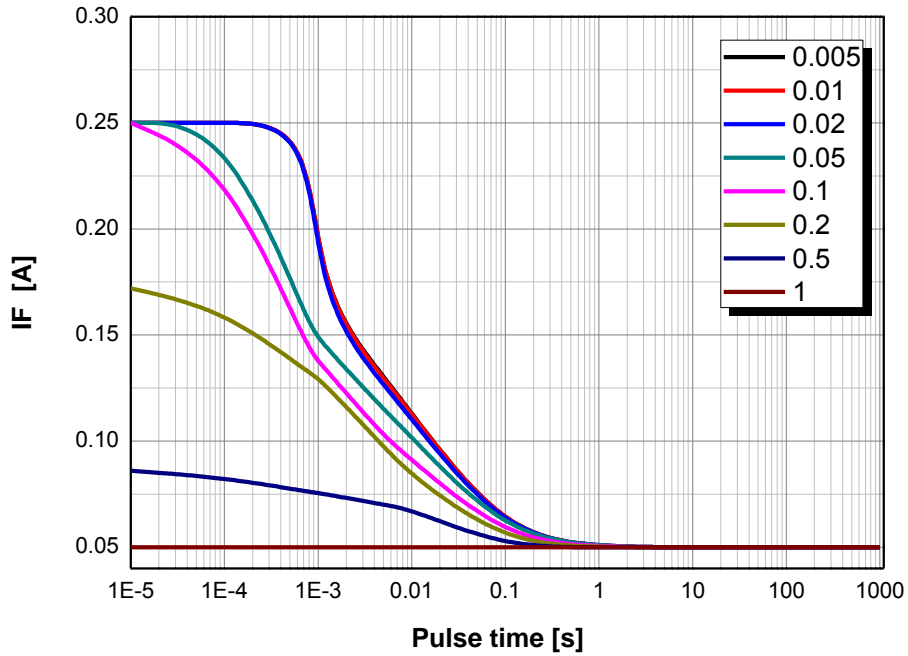

Fig 10.1. Pulse Permissibility (Red, $T_j = 25^\circ\text{C}$)



Characteristics Graph

Fig 10.2. Pulse Permissibility (Green, Blue, $T_j = 25^\circ\text{C}$)



Color Bin Structure

Table 3. Bin Code description

Color	Dominant Wavelength (nm)			Color Chromaticity Coordinate	Luminous Intensity (mcd)		
	Bin Code	Min.	Max.		Bin Code	Min.	Max.
Red	M	623	628	Refer to page.22	R1	560	710
	N	628	632		R2	710	900
Green	A	520	524		G1	1400	1800
	B	524	528		G2	1800	2300
	C	528	532				
Blue	R	462	465		B3	315	400
	S	465	468		B4	400	500
	T	468	471		B5	500	620

 **Available rank**

Color Bin Structure

CIE Chromaticity Diagram, $T_s=25^\circ\text{C}$, $I_f=20\text{mA}$

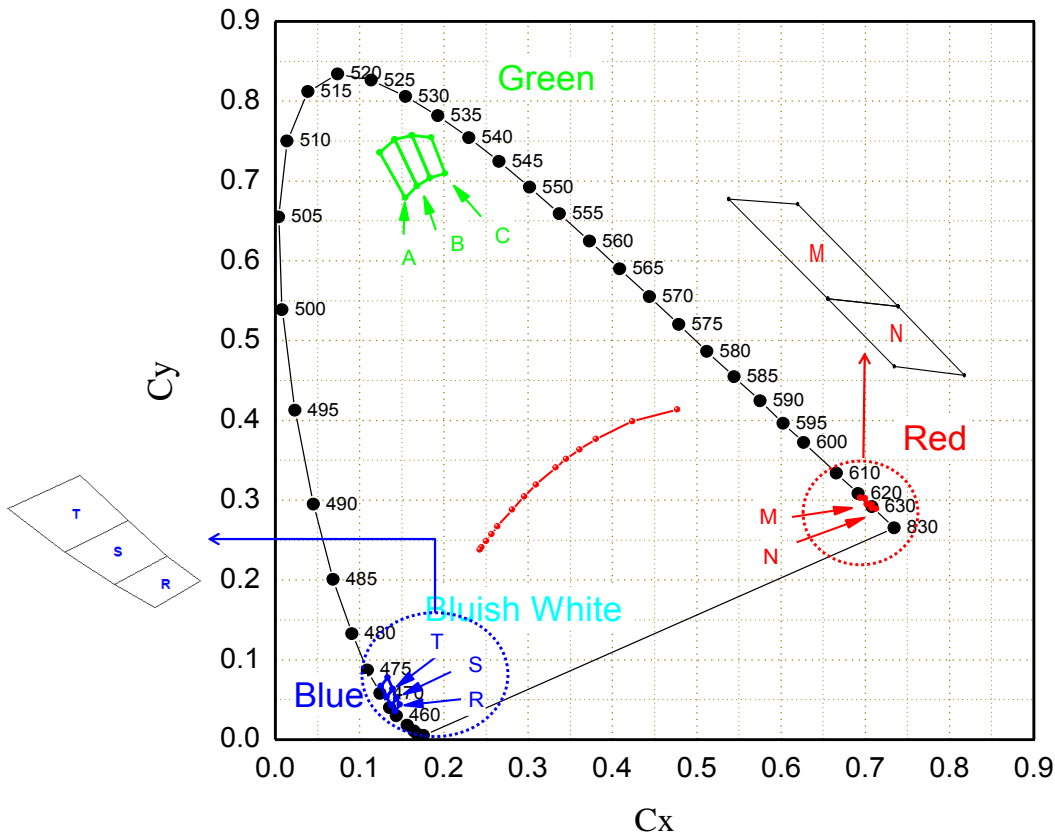

Red					
M		N			
CIE x	CIE y	CIE x	CIE y		
0.6943	0.3029	0.7022	0.2951		
0.7022	0.2951	0.7075	0.2898		
0.7052	0.2948	0.7105	0.2895		
0.6972	0.3027	0.7052	0.2948		
Green					
A		B		C	
CIE x	CIE y	CIE x	CIE y	CIE x	CIE y
0.1237	0.7359	0.1415	0.7518	0.1621	0.7570
0.1541	0.6790	0.1681	0.6938	0.1835	0.7040
0.1681	0.6938	0.1835	0.7040	0.2011	0.7096
0.1415	0.7518	0.1621	0.7570	0.1849	0.7548
Blue					
R		S		T	
CIE x	CIE y	CIE x	CIE y	CIE x	CIE y
0.1375	0.0428	0.1317	0.0532	0.1251	0.0672
0.1422	0.0353	0.1375	0.0428	0.1317	0.0532
0.1475	0.0439	0.1436	0.0519	0.1391	0.0634
0.1436	0.0519	0.1391	0.0634	0.1335	0.0779

Mechanical Dimensions

Top View

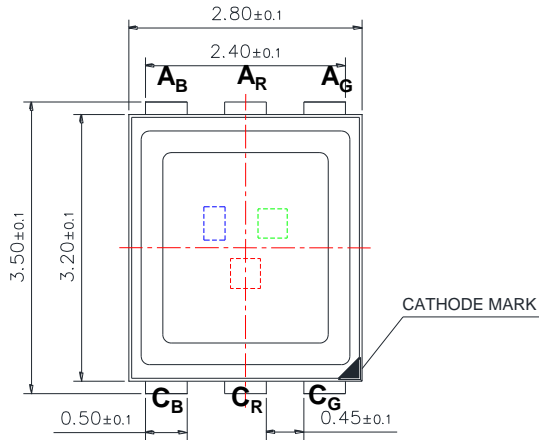

Side View

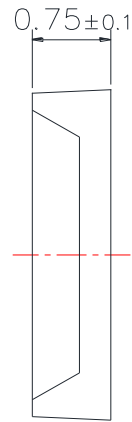

Bottom View

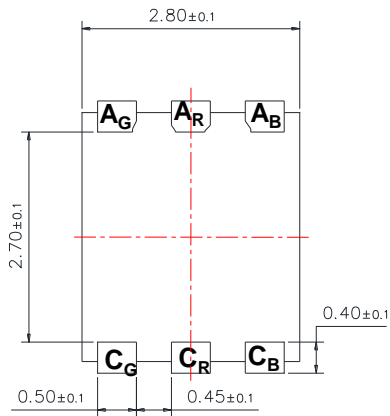

Circuit

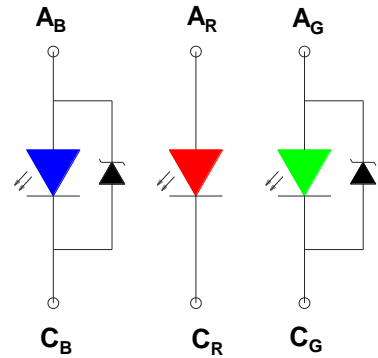

Notes :

- (1) All dimensions are in millimeters.
- (2) Scale : none
- (3) Undefined tolerance is ± 0.2 mm

Recommended Solder Pad

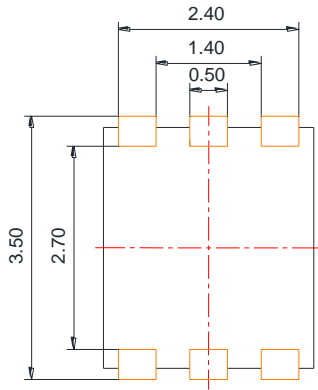
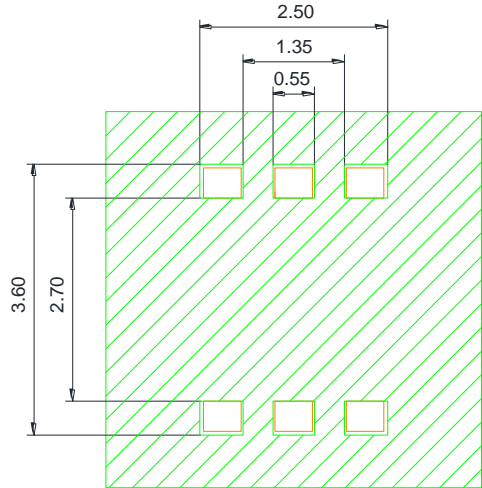
Recommended PCB Solder Pad

Solder Resist

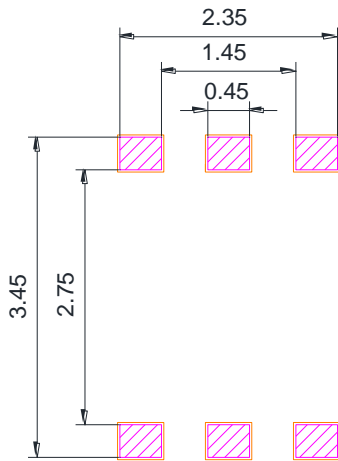
Solder Resist

Recommended Stencil Pattern

Stencil

Notes :

- (1) All dimensions are in millimeters.
- (2) Scale : none
- (3) This drawing without tolerances are for reference only.
- (4) Undefined tolerance is $\pm 0.1\text{mm}$.

Reflow Soldering Characteristics

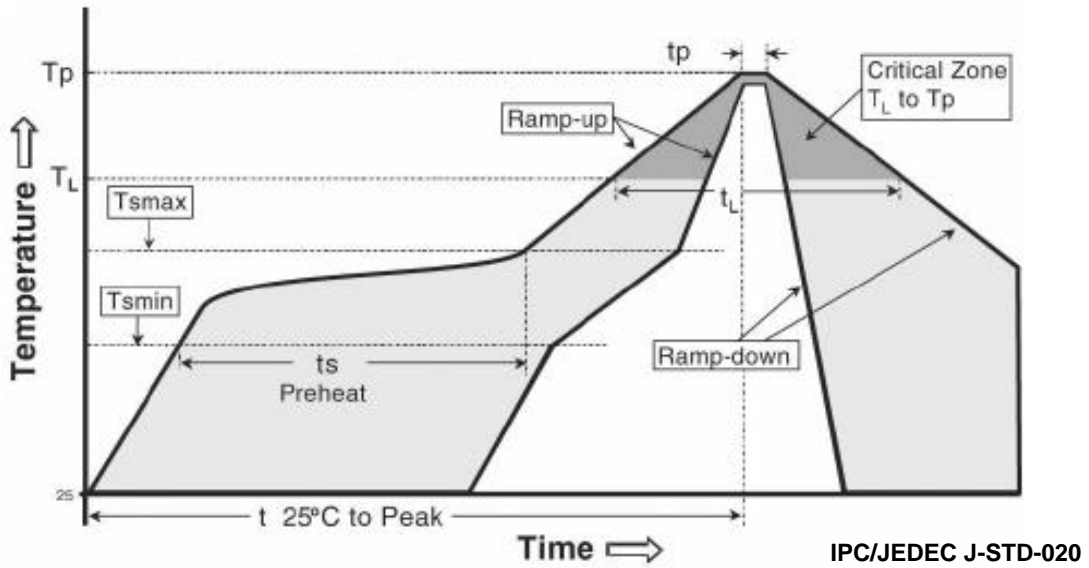
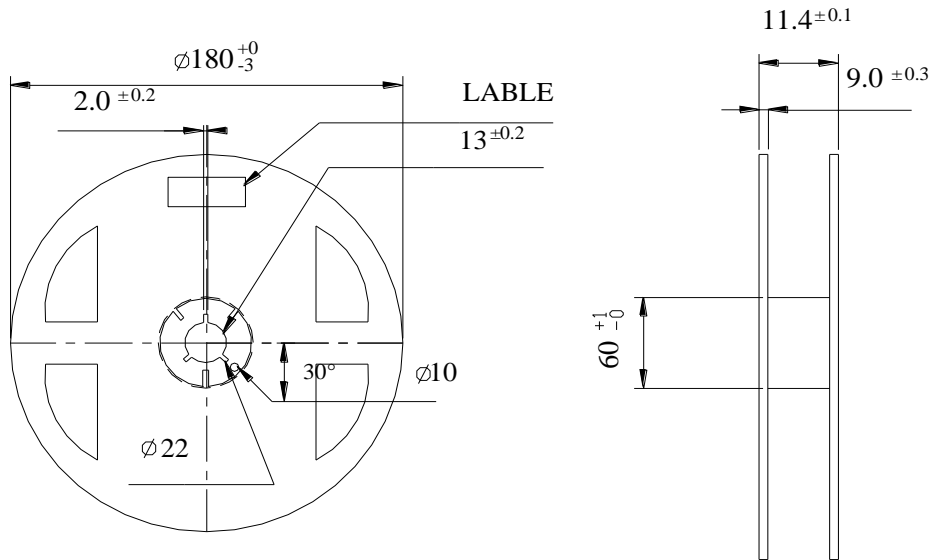
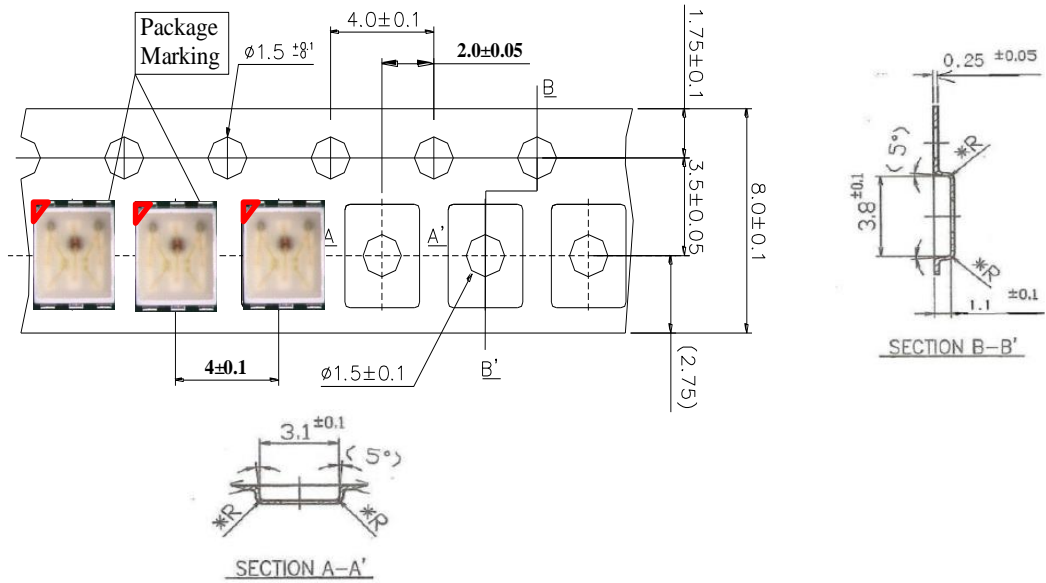

Table 4.

Profile Feature	Sn-Pb Eutectic Assembly	Pb-Free Assembly
Average ramp-up rate (T _{max} to T _p)	3° C/second max.	3° C/second max.
Preheat - Temperature Min (T _{min}) - Temperature Max (T _{max}) - Time (T _{min} to T _{max}) (ts)	100 °C 150 °C 60-120 seconds	150 °C 200 °C 60-180 seconds
Time maintained above: - Temperature (T _L) - Time (t _L)	183 °C 60-150 seconds	217 °C 60-150 seconds
Peak Temperature (T _p)	215°C	260°C
Time within 5°C of actual Peak Temperature (tp) ²	10-30 seconds	20-40 seconds
Ramp-down Rate	6 °C/second max.	6 °C/second max.
Time 25°C to Peak Temperature	6 minutes max.	8 minutes max.

Caution

- (1) Reflow soldering is recommended not to be done more than two times. In the case of more than 24 hours passed soldering after first, LEDs will be damaged.
- (2) Repairs should not be done after the LEDs have been soldered. When repair is unavoidable, suitable tools must be used.
- (3) Die slug is to be soldered.
- (4) When soldering, do not put stress on the LEDs during heating.
- (5) After soldering, do not warp the circuit board.

Emitter Tape & Reel Packaging

Notes :

- (1) Quantity : 3500pcs/Reel
- (2) All dimensions are in millimeters (tolerance : ± 0.3)
- (3) Scale none

Emitter Tape & Reel Packaging

Aluminum Bag

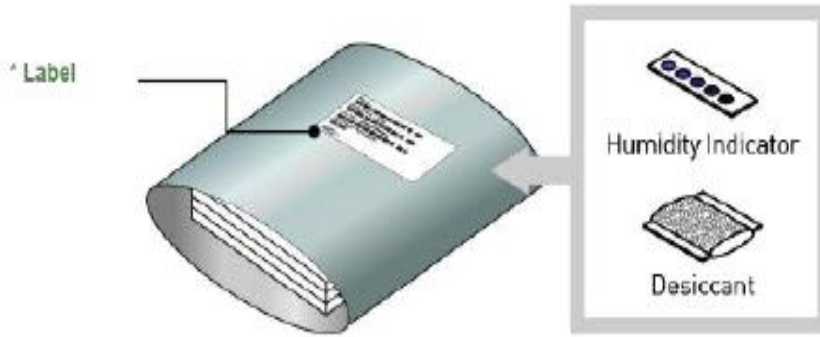

Outer Box

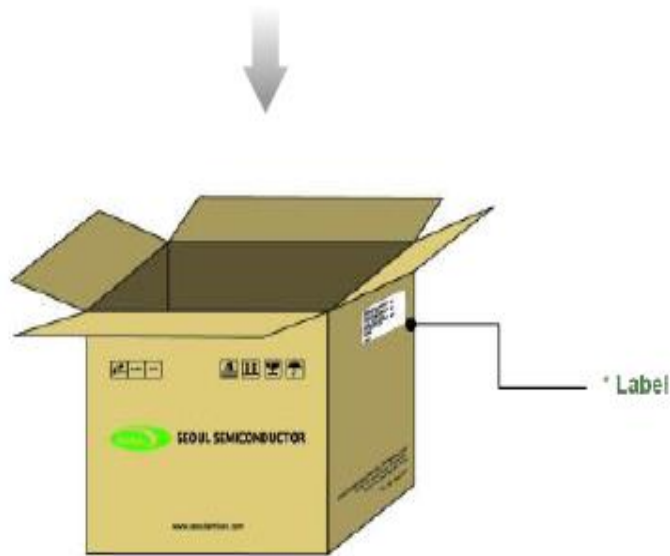

Notes :

- (1) Heat Sealed after packing (Use Zipper Bag)

Product Nomenclature

Table 5. Part Numbering System : X₁X₂X₃X₄X₅X₆X₇-X₈

Part Number Code	Description	Part Number	Value
X ₁	Company	S	SSC Code
X ₂	Top View LED series	T	Top view
X ₃ X ₄	Color	F0	Full Color
X ₅ X ₆ X ₇	Package information	A36	
X ₈₉	Product Revision	ZA	-
X ₁₀	Code	B	

Table 6. Lot Numbering System : Y₁Y₂Y₃Y₄Y₅Y₆Y₇Y₈Y₉Y₁₀-Y₁₁Y₁₂Y₁₃Y₁₄Y₁₅Y₁₆Y₁₇

Lot Number Code	Description	Lot Number	Value
Y ₁ Y ₂	Year		
Y ₃	Month		
Y ₄ Y ₅	Day		
Y ₆	Top View LED series		
Y ₇ Y ₈ Y ₉ Y ₁₀	Mass order		
Y ₁₁ Y ₁₂ Y ₁₃ Y ₁₄ Y ₁₅ Y ₁₆ Y ₁₇	Internal Number		

Handling of Silicone Resin for LEDs

- (1) During processing, mechanical stress on the surface should be minimized as much as possible. Sharp objects of all types should not be used to pierce the sealing compound.



- (2) In general, LEDs should only be handled from the side. By the way, this also applies to LEDs without a silicone sealant, since the surface can also become scratched.

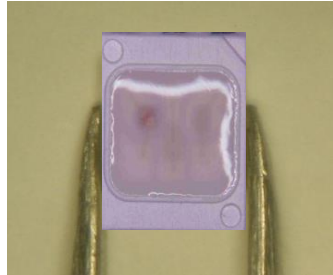

- (3) Silicone differs from materials conventionally used for the manufacturing of LEDs. These conditions must be considered during the handling of such devices. Compared to standard encapsulants, silicone is generally softer, and the surface is more likely to attract dust. As mentioned previously, the increased sensitivity to dust requires special care during processing. In cases where a minimal level of dirt and dust particles cannot be guaranteed, a suitable cleaning solution must be applied to the surface after the soldering of wire.
- (4) Seoul Semiconductor suggests using isopropyl alcohol for cleaning. In case other solvents are used, it must be assured that these solvents do not dissolve the package or resin. Ultrasonic cleaning is not recommended. Ultrasonic cleaning may cause damage to the LED.
- (5) Please do not mold this product into another resin (epoxy, urethane, etc) and do not handle this product with acid or sulfur material in sealed space.
- (6) Avoid leaving fingerprints on silicone resin parts.

Precaution for Use

(1) Storage

To avoid the moisture penetration, we recommend store in a dry box with a desiccant.

The recommended storage temperature range is 5°C to 30°C and a maximum humidity of RH50%.

(2) Use Precaution after Opening the Packaging

Use SMT techniques properly when you solder the LED as separation of the lens may affect the light output efficiency.

Pay attention to the following:

a. Recommend conditions after opening the package

- Sealing

- Temperature : 5 ~ 30°C Humidity : less than RH60%

b. If the package has been opened more than 4 week(MSL_2a) or the color of the desiccant changes, components should be dried for 10-24hr at 65±5°C

(3) For manual soldering

Seoul Semiconductor recommends the soldering condition

(ZC series product is not adaptable to reflow process)

a. Use lead-free soldering

b. Soldering should be implemented using a soldering equipment at temperature lower than 350°C.

c. Before proceeding the next step, product temperature must be stabilized at room temperature.

(4) Components should not be mounted on warped (non coplanar) portion of PCB.

(5) Radioactive exposure is not considered for the products listed here in.

(6) It is dangerous to drink the liquid or inhale the gas generated by such products when chemically disposed of.

(7) This device should not be used in any type of fluid such as water, oil, organic solvent and etc.

When washing is required, IPA (Isopropyl Alcohol) should be used.

(8) When the LEDs are in operation the maximum current should be decided after measuring the package temperature.

(9) LEDs must be stored properly to maintain the device. If the LEDs are stored for 3 months or more after being shipped from Seoul Semiconductor,

a sealed container with vacuum atmosphere should be used for storage.

(10) The appearance and specifications of the product may be modified for improvement without notice.

Precaution for Use

- (11) Long time exposure of sun light or occasional UV exposure will cause silicone discoloration.
- (12) Attaching LEDs, do not use adhesive that outgas organic vapor.
- (13) The driving circuit must be designed to allow forward voltage only when it is ON or OFF. If the reverse voltage is applied to LED, migration can be generated resulting in LED damage.
- (14) Please do not touch any of the circuit board, components or terminals with bare hands or metal while circuit is electrically active.
- (15) VOCs (Volatile organic compounds) emitted from materials used in the construction of fixtures can penetrate silicone encapsulants of LEDs and discolor when exposed to heat and photonic energy. The result can be a significant loss of light output from the fixture. Knowledge of the properties of the materials selected to be used in the construction of fixtures can help prevent these issues.
- (16) LEDs are sensitive to Electro-Static Discharge (ESD) and Electrical Over Stress (EOS). Below is a list of suggestions that Seoul Semiconductor purposes to minimize these effects.

a. ESD (Electro Static Discharge)

Electrostatic discharge (ESD) is defined as the release of static electricity when two objects come into contact. While most ESD events are considered harmless, it can be an expensive problem in many industrial environments during production and storage. The damage from ESD to LEDs may cause the product to demonstrate unusual characteristics such as:

- Increase in reverse leakage current lowered turn-on voltage
- Abnormal emissions from the LED at low current

The following recommendations are suggested to help minimize the potential for an ESD event. One or more recommended work area suggestions:

- Ionizing fan setup
- ESD table/shelf mat made of conductive materials
- ESD safe storage containers

One or more personnel suggestion options:

- Antistatic wrist-strap
- Antistatic material shoes
- Antistatic clothes

Environmental controls:

- Humidity control (ESD gets worse in a dry environment)

Precaution for Use

b. EOS (Electrical Over Stress)

Electrical Over-Stress (EOS) is defined as damage that may occur when an electronic device is subjected to a current or voltage that is beyond the maximum specification limits of the device.

The effects from an EOS event can be noticed through product performance like:

- Changes to the performance of the LED package
(If the damage is around the bond pad area and since the package is completely encapsulated the package may turn on but flicker show severe performance degradation.)
- Changes to the light output of the luminaire from component failure
- Components on the board not operating at determined drive power

Failure of performance from entire fixture due to changes in circuit voltage and current across total circuit causing trickle down failures. It is impossible to predict the failure mode of every LED exposed to electrical overstress as the failure modes have been investigated to vary, but there are some common signs that will indicate an EOS event has occurred:

- Damaged may be noticed to the bond wires (appearing similar to a blown fuse)
- Damage to the bond pads located on the emission surface of the LED package
(shadowing can be noticed around the bond pads while viewing through a microscope)
- Anomalies noticed in the encapsulation and phosphor around the bond wires.
- This damage usually appears due to the thermal stress produced during the EOS event.

c. To help minimize the damage from an EOS event Seoul Semiconductor recommends utilizing:

- A surge protection circuit
- An appropriately rated over voltage protection device
- A current limiting device



Company Information

Published by

Seoul Semiconductor © 2013 All Rights Reserved.

Company Information

Seoul Semiconductor (www.SeoulSemicon.com) manufactures and packages a wide selection of light emitting diodes (LEDs) for the automotive, general illumination/lighting, Home appliance, signage and back lighting markets. The company is the world's fifth largest LED supplier, holding more than 10,000 patents globally, while offering a wide range of LED technology and production capacity in areas such as "nPola", "Acrich", the world's first commercially produced AC LED, and "Acrich MJT - Multi-Junction Technology" a proprietary family of high-voltage LEDs.

The company's broad product portfolio includes a wide array of package and device choices such as Acrich and Acirch2, high-brightness LEDs, mid-power LEDs, side-view LEDs, and through-hole type LEDs as well as custom modules, displays, and sensors.

Legal Disclaimer

Information in this document is provided in connection with Seoul Semiconductor products. With respect to any examples or hints given herein, any typical values stated herein and/or any information regarding the application of the device, Seoul Semiconductor hereby disclaims any and all warranties and liabilities of any kind, including without limitation, warranties of non-infringement of intellectual property rights of any third party. The appearance and specifications of the product can be changed to improve the quality and/or performance without notice.

单击下面可查看定价，库存，交付和生命周期等信息

[>>Seoul Semiconductor\(首尔半导体\)](#)