

PART NUMBER (FROM 20Pos. TO 40Pos.)
10159549-120XXLF ~ 10159549-140XXLF

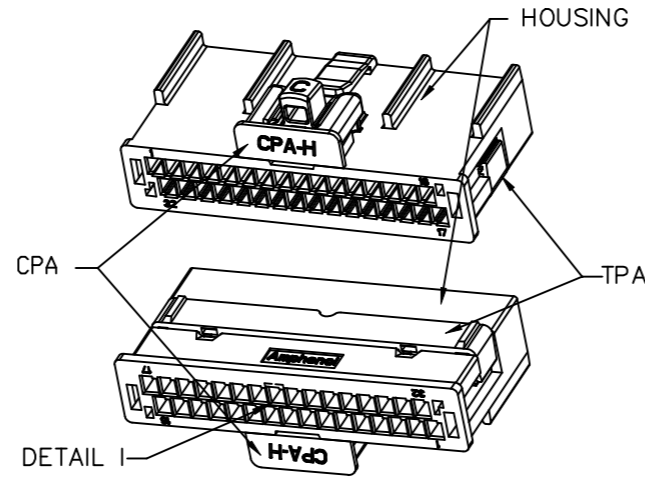
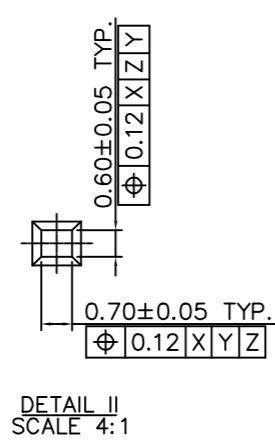
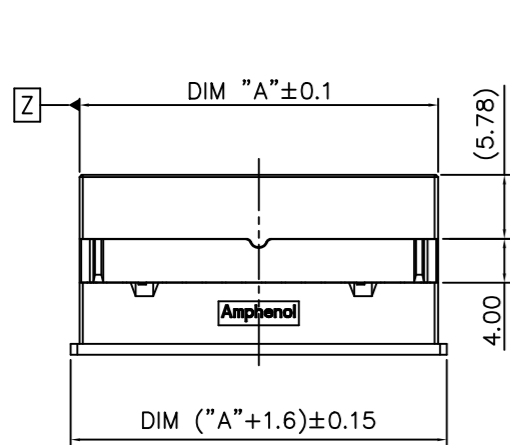
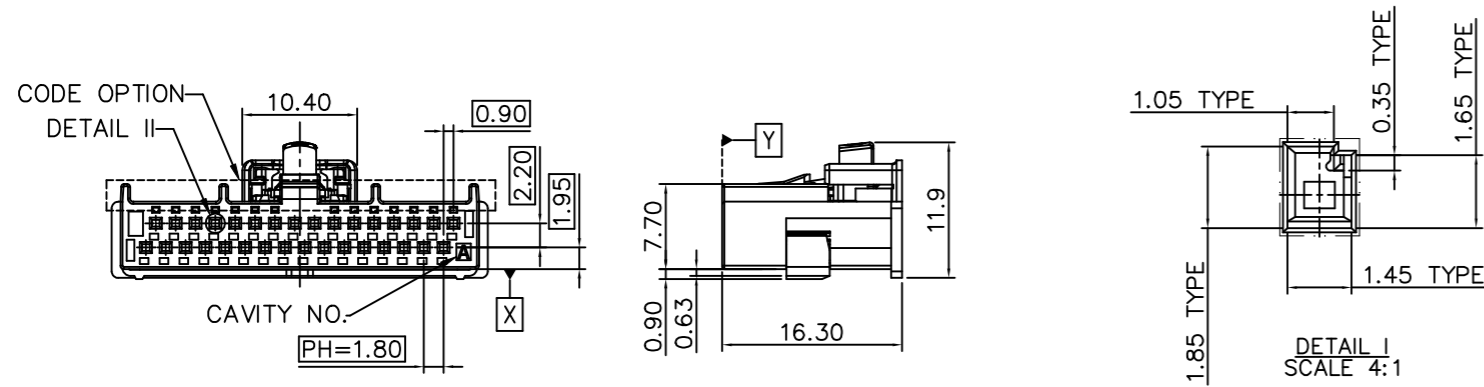

10159549-132XALF

POS.	PART NO.	DIM "A"	POS.	PART NO.	DIM "A"	POS.	PART NO.	DIM "A"
20	10159549-120XALF	21.70	28	10159549-128XALF	28.90	36	10159549-136XALF	36.10
	10159549-120XBLF			10159549-128XBLF			10159549-136XBLF	
	10159549-120XCFL			10159549-128KCFL			10159549-136XCFL	
	10159549-120XDLF			10159549-128KDLF			10159549-136XDLF	
22	10159549-122XALF	23.50	30	10159549-130XALF	30.70	38	10159549-138XALF	37.90
	10159549-122XBLF			10159549-130XBLF			10159549-138XBLF	
	10159549-122XCFL			10159549-130XCFL			10159549-138XCFL	
	10159549-122XDLF			10159549-130XDLF			10159549-138XDLF	
24	10159549-124XALF	25.30	32	10159549-132XALF	32.50	40	10159549-140XALF	39.70
	10159549-124XBLF			10159549-132XBLF			10159549-140XBLF	
	10159549-124XCFL			10159549-132XCFL			10159549-140XCFL	
	10159549-124XDLF			10159549-132XDLF			10159549-140XDLF	
26	10159549-126XALF	27.10	34	10159549-134XALF	34.30	REMARK, THIS SHEET SHOWS 20Pos. TO 40Pos.		
	10159549-126XBLF			10159549-134XBLF				
	10159549-126XCFL			10159549-134XCFL				
	10159549-126XDLF			10159549-134XDLF				

NOTES:

- 1 - MATERIAL: THERMOPLASTIC UL94V-0
COLOR: FOUR COLORS, DETAIL SEE TABLE
- 2 - PACKAGING SPEC: GS-14-2668
- 3 - PART NUMBER CODE: 10159549-1 XX X X LF

NUMBER OF POSITIONS
20 - 20 PINS
22 - 22 PINS
.....
40 - 40 PINS

RoHS COMPATIBLE
CODE OPTION + COLOR
A - A CODE
B - B CODE
C - C CODE
D - D CODE

PACKAGING
K - TRAY PACKAGE
T - PE BAG PACKAGE

A CODE / COLOR: BLACK	B CODE / COLOR: GREEN; COLOR CODE: RAL6002
C CODE / COLOR: WHITE; COLOR CODE: RAL9001	D CODE / COLOR: BORDEAUX; COLOR CODE: RAL4004
REMARK, THIS SHEET SHOWS 20Pos. TO 40Pos.	

mat'l. code		surface	tolerance	projection	product family
		ISO 1302	ISO 406/ISO 1101		HPL649
ltr		tolerances unless otherwise specified		mm	title
A	NEW DRAWING RELEASE	dr	DAISY WU		
B	ELX-N-40676	engr	NICK ZHANG	7/15/2022	RECEPTACLE KITS, DUAL ROW, WITH CPA WireLock® Series Cable Kits
C	ELX-N-46633	chr	ZK HU	7/15/2022	
		appd	TIM YAO	7/15/2022	dwg no
				sheet 1 of 3	
sheet index		revision	c		size
1~3					A4
					type
					Product Customer Drawing

PART NUMBER (FROM 14Pos. TO 18Pos.)

10159549-114XXLF ~ 10159549-118XXLF

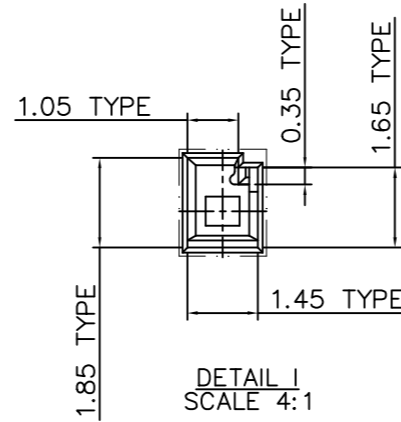
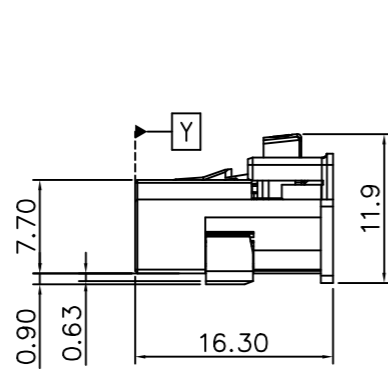
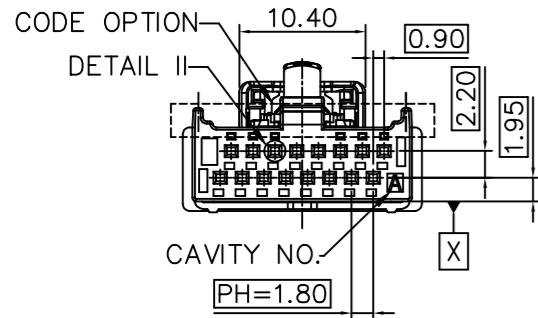

POS.	PART NO.	DIM "A"	POS.	PART NO.	DIM "A"
14	10159549-114XALF	16.30	18	10159549-118XALF	19.90
	10159549-114XBLF			10159549-118XBLF	
	10159549-114XCLF			10159549-118XCLF	
	10159549-114XDLF			10159549-118XDLF	
16	10159549-116XALF	18.10	REMARK, THIS SHEET SHOWS 14Pos. TO 18Pos.		
	10159549-116XBLF				
	10159549-116XCLF				
	10159549-116XDLF				

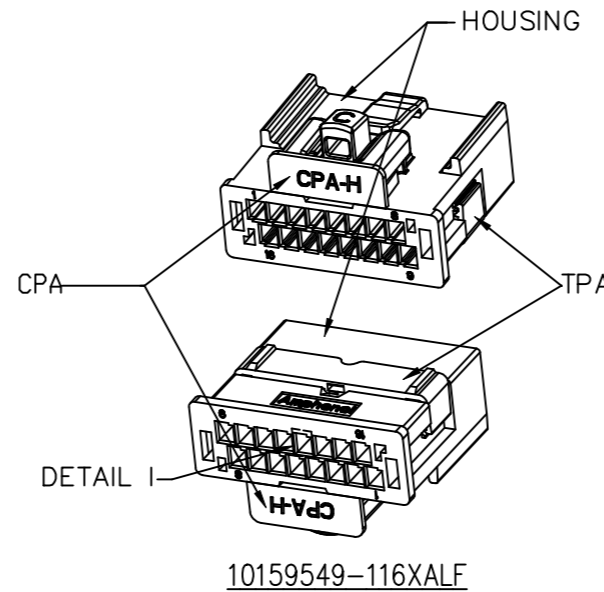
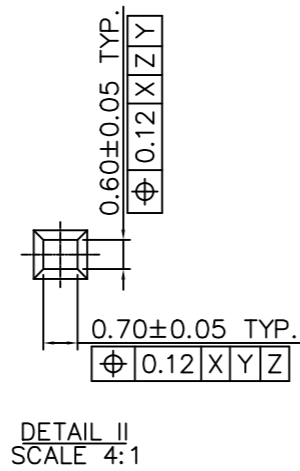
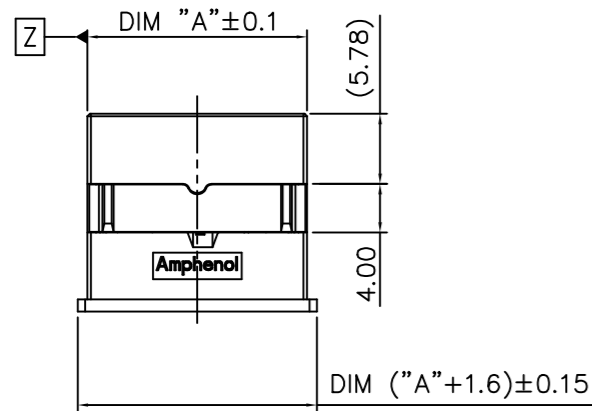

NOTES:

- 1 - MATERIAL: THERMOPLASTIC UL94V-0
COLOR: FOUR COLORS, DETAIL SEE TABLE
- 2 - PACKAGING SPEC: GS-14-2668
- 3 - PART NUMBER CODE: 10159549-1 XX X X LF

RoHS COMPATIBLE
CODE OPTION + COLOR
A - A CODE
B - B CODE
C - C CODE
D - D CODE

PACKAGING
K - TRAY PACKAGE
T - PE BAG PACKAGE

NUMBER OF POSITIONS
14 - 14 PINS
2
18 - 18 PINS

<p>A CODE / COLOR: BLACK</p>	<p>B CODE / COLOR: GREEN; COLOR CODE: RAL6002</p>
<p>C CODE / COLOR: WHITE; COLOR CODE: RAL9001</p>	<p>D CODE / COLOR: BORDEAUX; COLOR CODE: RAL4004</p>
<p>REMARK, THIS SHEET SHOWS 14Pos. TO 18Pos.</p>	

mat'l. code		surface	tolerance	projection	product family
ISO 1302		ISO 406/ISO 110			HPL649
ltr	ecn no	dr	date	tolerances unless otherwise specified	title
c				angles	RECEPTACLE KITS, DUAL ROW, WITH CPA
				linear	WireLock® Series Cable Kits
				0°±2'	dwg no
				.0±.3	sheet 2 of 3
				.00±.15	size
				.000±.010	10159549
				scale 1:1	A4
					type
					Product Customer Drawing
sheet index	revision	c			
	sheet	1~3			

PART NUMBER (FROM 10Pos. TO 12Pos.)
10159549-110XXLF ~ 10159549-112XXLF

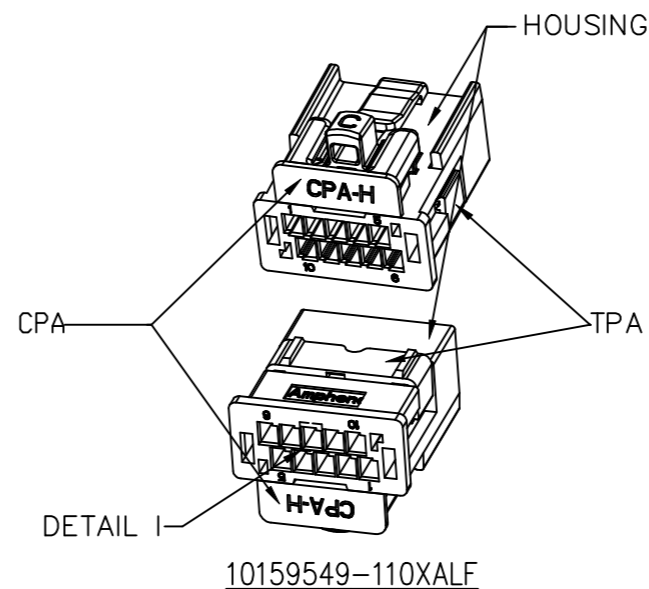
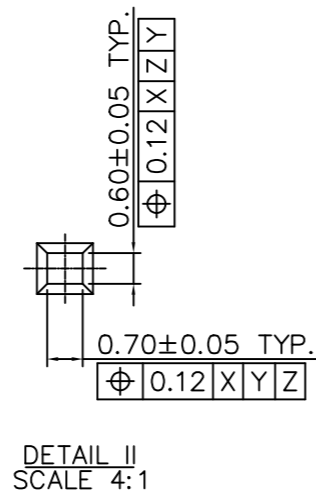
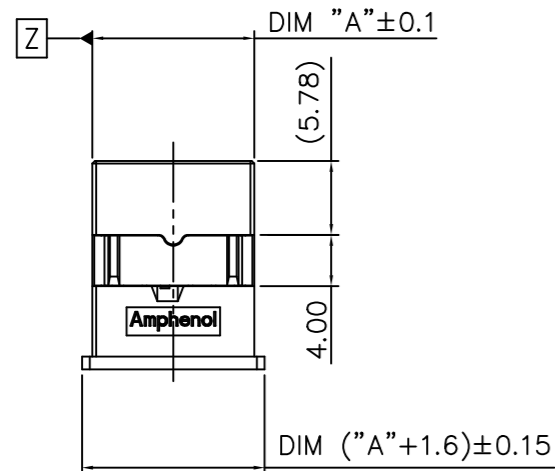
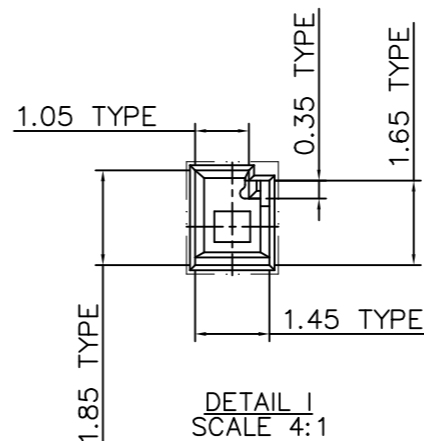
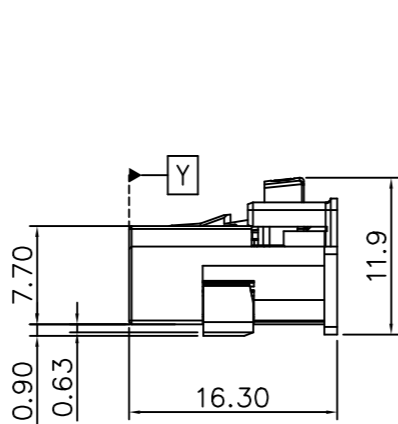
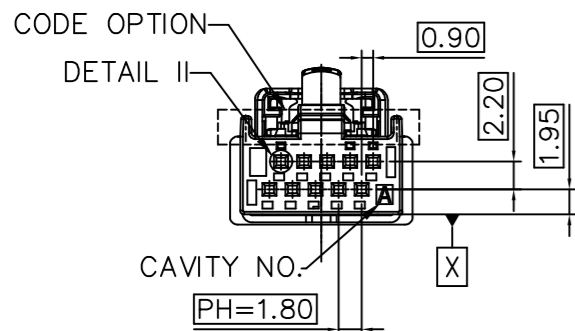

POS.	A CODE / COLOR: BLACK
10	
12	
REMARK, THIS SHEET SHOWS 10Pos. TO 12Pos. NO B/C/D CODE TO PROVIDE.	

POS.	PART NO.	DIM "A"	POS.	PART NO.	DIM "A"
10	10159549-110XALF	12.70	12	10159549-112XALF	14.50
REMARK, THIS SHEET SHOWS 10Pos. TO 12Pos.					

NOTES:

- 1 - MATERIAL: THERMOPLASTIC UL94V-0
COLOR: FOUR COLORS, DETAIL SEE TABLE
- 2 - PACKAGING SPEC: GS-14-2668
- 3 - PART NUMBER CODE: 10159549-1 XX X X LF
 - RoHS COMPATIBLE
 - CODE OPTION + COLOR
 - A - A CODE (NO B/C/D CODE TO PROVIDE.)
 - PACKAGING
 - K - TRAY PACKAGE
 - T - PE BAG PACKAGE

NUMBER OF POSITIONS
10 - 10 PINS
2
12 - 12 PINS

mat'l. code		surface	tolerance	projection	product family
		ISO 1302	ISO 406/ISO 1101		HPL649
ltr	ecn no	dr	date	tolerances unless otherwise specified	title
c				angles	RECEPTACLE KITS, DUAL ROW, WITH CPA
				linear	WireLock® Series Cable Kits
				0°±2'	dwg no
				.0±.3	sheet 3 of 3
				.00±.15	size
				.000±.010	10159549
				scale 1:1	A4
					type
					Product Customer Drawing
sheet index	revision	c			
	sheet	1~3			

单击下面可查看定价，库存，交付和生命周期等信息

[>>Amphenol\(安费诺\)](#)